



Easy Access Rules for ATM-ANS (Regulation (EU) 2017/373)

EASA eRules: aviation rules for the 21st century

Rules are the core of the EU civil aviation system. The aim of the **EASA eRules** project is to make them **accessible** to stakeholders in an efficient and reliable way.

EASA eRules is a comprehensive, single system for structuring, sharing, and storing of rules. It is the single, easy-access online database for all aviation safety rules applicable to persons and organisations subject to Basic Regulation (Regulation (EU) 2018/1139).

Easy Access Rules (EAR) are the output of the eRules project. They are consolidated versions of those rules, combining EU regulations with EASA acceptable means of compliance (AMC) and guidance material (GM) in an easy-to-read format with advanced navigation features through links and bookmarks. EAR are regularly updated, following the adoption of an official publication.

The **EAR** are available:

- in PDF format;
- as dynamic online publications (online format) with a wide range of functionalities, such as filters to obtain regulatory material tailored to one's needs, a search function through the table of contents to quickly access the relevant sections, and easy navigation for computers, tablets, and mobiles; and
- in XML (machine-readable format) that can be easily processed and automated by recipients, producing output that is compatible and can be synchronised with local applications, search databases, etc.

The **EASA eRules** system is developed and implemented in close cooperation with the Member States and aviation industry to ensure that all its capabilities are relevant and effective.

Published February 2023¹

Copyright notice

© European Union, 1998-2023

Unless otherwise specified, you can re-use the legal documents published in EUR-Lex for commercial or non-commercial purposes [...] ('© European Union, <http://eur-lex.europa.eu/>, 1998-2023')².

¹ The published date represents the date when the consolidated version of the document was generated.

² Euro-Lex, Important Legal Notice: <http://eur-lex.europa.eu/content/legal-notice/legal-notice.html>.

DISCLAIMER

This document is issued by the European Union Aviation Safety Agency (referred to as both 'EASA' and 'the Agency') to provide its stakeholders with an updated, consolidated, and easy-to-read publication. It has been prepared by putting together the officially published EU regulations with the related EASA acceptable means of compliance (AMC) and guidance material (GM) (including their amendments) adopted so far. However, this is not an official publication, and EASA accepts no liability for damage of any kind resulting from the risks inherent in its use.

LIST OF REVISIONS

Published	Reason for revision
November 2017	First Easy Access Rules document powered by eRules.
December 2017	To incorporate a missing table in GM1 ATM/ANS.OR.A.001 Scope.
February 2018	To correct a minor editorial mistake.
June 2018	To correct an editorial error in GM1 to AMC2 ATS.OR.205(a)(2), paragraph (a)(4) and to correct the applicability dates for the Implementing Rules (IRs).
December 2019	To incorporate ED Decision 2019/022/R amending AMC and GM to ATM/ANS rules on software assurance level requirements for safety (support) assessment of changes to air traffic management/air navigation services functional systems.
October 2020	To incorporate Commission Implementing Regulation (EU) 2020/469 on requirements for air traffic management/air navigation services, design of airspace structures and data quality, runway safety as well as ED Decision 2020/008/R thereto in order to facilitate the uniform implementation of the requirements by providing suitable tools for the ATM/ANS providers and the competent authorities when performing certification and oversight in ATS, MET, AIS, FPD and design of airspace structures.
December 2020	To incorporate ED Decision 2020/017/R serving as a corrigendum to AMC1 ATS.TR.305 and GM1 ATS.TR.305 (Part-ATS) issued with ED Decision 2020/008/R. Additionally, to correct the previous publication and remove AIS.TR.100 as amended by Commission Implementing Regulation (EU) 2020/469.
January 2021	To incorporate ED Decision 2020/020/R amending the AMC and GM to Annex XIII (Part-PERS) to Commission Implementing Regulation (EU) 2017/373 (the 'ATM/ANS Regulation') as regards the update of the initial-training objectives for air traffic safety electronics personnel (ATSEP).
March 2021	To correct an editorial error.
July 2021	To incorporate ED Decision 2021/008/R amending the AMG and GM to Annex-VIII (Part-CNS) to Commission Implementing Regulation (EU) 2017/373 (the 'ATM/ANS Regulation'), which introduced a new AMC on the conditions applicable to the provider of the transmission service for locating an aircraft in distress.
September 2021	To correct editorial errors in Annex IV (Part-ATS).
November 2022	To incorporate the following acts: <ul style="list-style-type: none"> - Corrigendum to Commission Implementing Regulation (EU) 2020/469 of 14 February 2020 amending Regulation (EU) No 923/2012, Regulation (EU) No 139/2014 and Regulation (EU) 2017/373 as regards requirements for air traffic management/air navigation services, design of airspace structures and data quality, runway safety and repealing Regulation (EC) No 73/2010; - Commission Implementing Regulation (EU) 2020/1177 of 7 August 2020 amending Implementing Regulation (EU) 2020/469 as regards postponing dates of application of certain measures in the context of the COVID-19 pandemic; - Commission Implementing Regulation (EU) 2021/665 of 22 April 2021 amending Implementing Regulation (EU) 2017/373 as regards requirements for providers of air traffic management/air navigation services and other air traffic management network functions in the U-space airspace designated in controlled airspace;

	<ul style="list-style-type: none"> - Commission Implementing Regulation (EU) 2021/1338 amending Implementing Regulation (EU) 2017/373 as regards reporting requirements and reporting channels between organizations, and requirements for meteorological services; - ED Decision 2022/004/R introducing and amending the AMC and GM on occurrence reporting and on meteorological services; - Commission Implementing Regulation (EU) 2022/938 of 26 July 2022 amending Implementing Regulation (EU) 2017/373 as regards the requirements for aeronautical data catalogue and aeronautical information publication; - ED Decision 2022/015/R introducing and amending the AMC and GM to Part-AIS.
Correction from January 2023	<p>To correct editorial errors in:</p> <ul style="list-style-type: none"> - List of revisions; - Annex VI – Part-AIS (particularly in AIS.TR.515 Data set updates); - Change of location of AMC1 AIS.OR.505(2) Aeronautical information regulation and control (AIRAC).
February 2023	<ul style="list-style-type: none"> - To remove the special formatting from the rules applicable from 26 January 2023; and - to incorporate ED Decision 2022/023/R amending the AMG and GM to Annex IV (Part-ATS) to Commission Implementing Regulation (EU) 2017/373 to support the implementation of the U-space Regulation (Regulation (EU) 2021/665).

NOTE FROM THE EDITOR

The content of this document is arranged as follows: the cover regulation (recitals and articles) of the implementing rule (IR) appear first, then the IR annex points, followed by the related acceptable means of compliance (AMC) and guidance material (GM).

All elements (i.e. articles, IRs, AMC, and GM) are colour-coded and can be identified according to the illustration below. The EU regulation or EASA Executive Director (ED) decision through which the article, IR, AMC, or GM was introduced or last amended is indicated below the article, IR, AM, or GM title in *italics*.

<u>Cover regulation article</u>	<i>Commission regulation</i>
Implementing rule	<i>Commission regulation</i>
Acceptable means of compliance	<i>ED decision</i>
Guidance material	<i>ED decision</i>

This document will be updated regularly to incorporate further amendments.

The format of this document has been adjusted to make it user-friendly and for reference purposes. Any comments should be sent to erules@easa.europa.eu.

INCORPORATED AMENDMENTS

IMPLEMENTING RULES (IRs) (COMMISSION REGULATIONS)

Incorporated Commission Regulation	Affected Part	Regulation amendment	Applicability date ^{1, 2}
Regulation (EU) 2017/373	Annex I (Part-DEFINITIONS)	N/A	2/1/2020, except for the Agency and the DAT providers
	Annex II (Part-ATM/ANS.AR)		2/1/2020, except for the Agency
	Annex III (Part-ATM/ANS.OR)		2/1/2020, except for the DAT providers
	Annex IV (Part-ATS)		2/1/2020
	Annex V (Part-MET)		2/1/2020
	Annex VI (Part-AIS)		2/1/2020
	Annex VII (Part-DAT)		1/1/2019 or 28/3/2017
	Annex VIII (Part-CNS)		2/1/2020
	Annex IX (Part-ATFM)		2/1/2020
	Annex X (Part-ASM)		2/1/2020
	Annex XI (Part-ASD)		N/A
	Annex XII (Part-NM)		2/1/2020
	Annex XIII (Part-PERS)		2/1/2020, except for the DAT providers
Regulation (EU) 2020/469	Annex I (Part-DEFINITIONS)	First amending Regulation	27/1/2022
	Annex II (Part-ATM/ANS.AR)		27/1/2022
	Annex III (Part-ATM/ANS.OR)		27/1/2022
	Annex IV (Part-ATS)		27/1/2022
	Annex V (Part-MET)		5/11/2020
	Annex VI (Part-AIS)		27/1/2022, except Appendix 3 'SNOWTAM FORMAT'
	Annex XI (Part-FPD)		27/1/2022
Corrigendum to Commission Implementing Regulation (EU) 2020/469	Annex III (Part-ATM/ANS.OR)	Corrigendum	
	Annex VI (Part-AIS)		
	Annex V (Part-MET)		12/8/2021

¹ This is the date of application (i.e. the date from which an act or a provision in an act produces its full legal effects) as defined in the relevant cover regulation article. Some provisions of the regulations though may be applicable at a later date (deferred applicability). Besides, there may be some opt-outs (derogations from certain provisions) notified by the Member States.

² Regulation (EU) 2017/373 shall apply from 2 January 2020. However:
- in respect of the Agency, Article 4(1), (2), (5), (6) and (8) and Article 5 shall apply from the date of entry into force of this Regulation;
- in respect of data services providers, Article 6 shall apply in any case from 1 January 2019 and, where such a provider applies for and is granted a certificate in accordance with Article 6, from the date of entry into force of this Regulation.

Regulation (EU) 2020/1177	Annex VI (Part-AIS)	Second amending Regulation	
Regulation (EU) 2021/665	Annex I (Part-DEFINITIONS)	Third amending Regulation	26/1/2023
	Annex IV (Part-ATS)		
Regulation (EU) 2021/1338	Annex I (Part-DEFINITIONS)	Forth amending Regulation	1/9/2021
	Annex II (Part-ATM/ANS.AR)		1/9/2021
	Annex III (Part-ATM/ANS.OR)		1/9/2021,
	Annex V (Part-MET)		1/9/2021, except for Point 32 which shall apply from 12/8/2021
	Annex VI (Part-AIS)		12/8/2021
Regulation (EU) 2022/938	Annex I (Part-DEFINITIONS)	Fifth amending Regulation	30/8/2022
	Annex III (Part-ATM/ANS.OR)		30/8/2022
	Annex VI (Part-AIS)		30/8/2022

AMC/GM TO IRs (ED DECISIONS)

Incorporated ED Decision	Affected AMC/GM	AMC/GM Issue No, Amendment No	Applicability date
ED Decision 2017/001/R	GM to Definitions of terms used in Annexes II to XIII to Commission Implementing Regulation (EU) 2017/373	Initial issue	2/1/2020, except for DAT providers
	AMC and GM to Part-ATM/ANS.AR (Annex II to ED Decision 2017/001/R)		2/1/2020, except for the Agency
	AMC and GM to Part-ATM/ANS.OR (Annex III to ED Decision 2017/001/R)		2/1/2020, except for DAT providers
	AMC and GM to Part-ATS (Annex IV to ED Decision 2017/001/R)		2/1/2020
	AMC and GM to Part-MET (Annex V to ED Decision 2017/001/R)		2/1/2020
	AMC and GM to Part-AIS (Annex VI to ED Decision 2017/001/R)		2/1/2020
	AMC and GM to Part-DAT (Annex VII to ED Decision 2017/001/R)		1/1/2019 or 28/3/2017
	AMC and GM to Part-CNS (Annex VIII to ED Decision 2017/001/R)		2/1/2020
	AMC and GM to Part-ATFM (Annex IX to ED Decision 2017/001/R)		2/1/2020
	AMC and GM to Part-ASM (Annex X to ED Decision 2017/001/R)		2/1/2020
	AMC and GM to Part-ASD (Annex XI to ED Decision 2017/001/R)		N/A
	AMC and GM to Part-NM (Annex XII to ED Decision 2017/001/R)		2/1/2020
	AMC and GM to Part-PERS (Annex XIII to ED Decision 2017/001/R)		2/1/2020, except for DAT providers
	AMC and GM to Regulation (EU) 2017/373 (Annex XIV to ED Decision 2017/001/R)		2/1/2020, except for DAT providers
ED Decision 2019/022/R	GM to Part-Definitions	Amendment 1	31/10/2019
	AMC and GM to Part-ATM/ANS.AR		
	AMC and GM to Part-ATM/ANS.OR		
	AMC and GM to Part-ATS		
ED Decision 2020/008/R	GM to Part-Definitions	Issue 1, Amendment 2	27/1/2022
	AMC & GM to Part-ATM/ANS.AR	Issue 1, Amendment 2	27/1/2022
	AMC & GM to Part-ATM/ANS.OR	Issue 1, Amendment 2	27/1/2022
	AMC & GM to Part-ATS	Issue 1, Amendment 2	27/1/2022

	AMC & GM to Part-MET	Issue 1, Amendment 1	5/11/2020
	AMC & GM to Part-AIS	Issue 1, Amendment 1	27/1/2022
	AMC & GM to Part-FPD	Issue 1, Amendment 1	27/1/2022
	AMC & GM to Commission Implementing Regulation (EU) 2017/373	Issue 1, Amendment 1	27/1/2022
ED Decision 2020/017/R	AMC & GM to Part-ATS	Issue 1, Amendment 3	27/1/2022
ED Decision 2020/020/R	AMC & GM to Part-PERS	Amendment 1	1/7/2021
ED Decision 2021/008/R	AMC & GM to Part-CNS	Issue 1, Amendment 1	30/6/2021
ED Decision 2022/004/R	AMC & GM to Part-DEFINITIONS	Issue 1, Amendment 3	13/6/2022
	AMC & GM to Part-ATM/ANS.AR	Issue 1, Amendment 3	13/6/2022
	AMC & GM to Part-ATM/ANS.OR	Issue 1, Amendment 3	13/6/2022
	AMC & GM to Part-MET	Issue 1, Amendment 2	13/6/2022
ED Decision 2022/015/R	AMC & GM to Part-AIS	Issue 1, Amendment 2	30/8/2022
ED Decision 2022/023/R	AMC & GM to Part-ATS	Issue 1, Amendment 4	26/1/2023

Note: To access the official versions, please click on the hyperlinks provided above.

TABLE OF CONTENTS

Disclaimer	3
List of revisions	4
Note from the editor	6
Incorporated amendments	7
Table of contents	11
Cover Regulation	43
Article 1 Subject matter	47
GM1 Article 1 ‘Subject matter’	47
GM2 Article 1 Subject matter.....	47
Article 2 Definitions	48
GM1 Article 2 ‘Definitions’	48
Article 3 Provision of ATM/ANS and design of airspace structures	49
GM1 Article 3(1) Provision of ATM/ANS and design of airspace structures	50
GM1 Article 3(5) Provision of ATM/ANS and design of airspace structures	50
AMC1 Article 3(6) Provision of ATM/ANS and design of airspace structures	51
AMC2 Article 3(6) Provision of ATM/ANS and design of airspace structures	51
GM1 to AMC2 Article 3(6) (a) Provision of ATM/ANS and design of airspace structures	51
AMC3 Article 3(6) Provision of ATM/ANS and design of airspace structures	51
GM1 Article 3(6) Provision of ATM/ANS and design of airspace structures	52
GM1 Article 3(8) Provision of ATM/ANS and design of airspace structures	52
GM2 Article 3(8) Provision of ATM/ANS and design of airspace structures	55
AMC1 Article 3(9) Provision of ATM/ANS and design of airspace structures	56
Article 3a Determination of the need for the provision of air traffic services	57
GM1 Article 3a(1) Determination of the need for the provision of air traffic services... 57	
GM2 Article 3a(1) Determination of the need for the provision of air traffic services.... 57	
Article 3b Coordination between military units and air traffic service providers	58
GM1 to Article 3b(b) Coordination between military authorities and air traffic service providers.....	59

Article 3c Coordination of air operations potentially hazardous to civil aviation	59
GM2 Article 3c(1) Coordination of air operations potentially hazardous to civil aviation	59
GM1 Article 3c(2) Coordination of air operations potentially hazardous to civil aviation	59
Article 3d Very-high frequency (VHF) emergency frequency.....	60
GM1 Article 3d(2) Very-high frequency (VHF) emergency frequency	60
Article 4 Competent authority for certification, oversight and enforcement	60
GM1 Article 4(5) ‘Competent authority for certification, oversight and enforcement’ ..	61
GM2 Article 4(5) ‘Competent authority for certification, oversight and enforcement’ ..	62
AMC1 Article 4(8) ‘Competent authority for certification, oversight and enforcement’	62
Article 5 Powers of the competent authority referred to in Article 4	62
AMC1 Article 5 ‘Powers of the competent authority referred to in Article 4’	63
Article 6 Service providers	63
GM1 Article 6 ‘Service providers’	64
Article 7 Declaration by providers of flight information services	64
Article 8 Existing certificates	64
Article 9 Repeal and amendment	64
Article 10 Entry into force	65
GM1 Article 10 ‘Entry into force’	65
ANNEX I — Part-DEFINITIONS.....	66
GM1 2. Aerial work.....	82
GM1 9. Aeronautical data	83
GM1 20. Air traffic safety electronics personnel (ATSEP)	83
GM2 20. Air traffic safety electronics personnel (ATSEP)	84
GM1 32. Authoritative source	84
GM1 42. Data quality requirements (DQRs)	84
GM1 56. Functional system.....	84
GM1 74. Obstacle	85
GM1 101. Terrain	85
GM1 130. Air traffic control clearance or ATC clearance.....	85
GM1 138. Assemble.....	85
GM1 139. ATS route	85
GM1 141. ATS surveillance system.....	86
GM1 143. Automatic dependent surveillance — contract (ADS-C)	86

GM1 152. Confidence level	86
GM1 155. Controlled aerodrome	86
GM1 156. Controlled airspace.....	86
GM1 170. Data product specification.....	86
GM1 196. Integrity classification.....	87
GM1 203. Instrument approach operations	87
GM1 208. Metadata	87
GM1 232. Significant point.....	87
GM1 (262) 'SPACE WEATHER CENTRE (SWXC)'	87

ANNEX II — Part-ATM/ANS.AR..... 88

SUBPART A — GENERAL REQUIREMENTS 88

ATM/ANS.AR.A.001 Scope.....	88
ATM/ANS.AR.A.005 Certification, oversight and enforcement tasks	88
AMC1 ATM/ANS.AR.A.005(b) Certification, oversight and enforcement tasks.....	89
GM1 ATM/ANS.AR.A.005(b) Certification, oversight and enforcement tasks.....	89
GM2 ATM/ANS.AR.A.005(b) Certification, oversight and enforcement tasks.....	89
GM1 ATM/ANS.AR.A.005(c) Certification, oversight and enforcement tasks	89
ATM/ANS.AR.A.010 Certification, oversight and enforcement documentation.....	90
ATM/ANS.AR.A.015 Means of compliance.....	90
GM1 ATM/ANS.AR.A.015 Means of compliance	91
AMC1 ATM/ANS.AR.A.015(d)(3) Means of compliance.....	91
ATM/ANS.AR.A.020 Information to the Agency.....	91
AMC1 ATM/ANS.AR.A.020(b) Information to the Agency	92
GM1 ATM/ANS.AR.A.020(b) Information to the Agency	92
GM2 ATM/ANS.AR.A.020(b) Information to the Agency	92
GM3 ATM/ANS.AR.A.020(b) Information to the Agency	92
ATM/ANS.AR.A.025 Immediate reaction to safety problem.....	93
ATM/ANS.AR.A.030 Safety directives.....	93
GM1 ATM/ANS.AR.A.030 Safety directives	94
GM2 ATM/ANS.AR.A.030(b) Safety directives	94
GM3 ATM/ANS.AR.A.030(c) Safety directives	95

SUBPART B — MANAGEMENT (ATM/ANS.AR.B) 96

ATM/ANS.AR.B.001 Management system	96
AMC1 ATM/ANS.AR.B.001(a)(2) Management system	97
AMC2 ATM/ANS.AR.B.001(a)(2) Management system	97
GM1 ATM/ANS.AR.B.001(a)(2) Management system	98
AMC1 ATM/ANS.AR.B.001(a)(4) Management system	99
ATM/ANS.AR.B.005 Allocation of tasks to qualified entities	100
AMC1 ATM/ANS.AR.B.005 Allocation of tasks to qualified entities	100
GM1 ATM/ANS.AR.B.005 Allocation of tasks to qualified entities	101

ATM/ANS.AR.B.010 Changes in the management system.....	101
ATM/ANS.AR.B.015 Record-keeping	101
AMC1 ATM/ANS.AR.B.015(a)(2) Record-keeping	102
AMC1 ATM/ANS.AR.B.015(a)(8) Record-keeping	102
SUBPART C — OVERSIGHT, CERTIFICATION AND ENFORCEMENT (ATM/ANS.AR.C)	103
ATM/ANS.AR.C.001 Monitoring of safety performance	103
ATM/ANS.AR.C.005 Certification, declaration, and verification of service providers' compliance with the requirements	103
ATM/ANS.AR.C.010 Oversight.....	104
GM1 ATM/ANS.AR.C.010 Oversight.....	104
AMC1 ATM/ANS.AR.C.010(a) Oversight	105
GM1 ATM/ANS.AR.C.010(b)(1) Oversight.....	105
ATM/ANS.AR.C.015 Oversight programme	105
AMC1 ATM/ANS.AR.C.015 Oversight programme.....	106
AMC1 ATM/ANS.AR.C.015(a) Oversight programme	107
AMC1 ATM/ANS.AR.C.015(a)(1) Oversight programme	107
ATM/ANS.AR.C.020 Issue of certificates	107
GM1 ATM/ANS.AR.C.020(c) Issue of certificates.....	108
GM2 ATM/ANS.AR.C.020(c) Issue of certificates.....	108
GM3 ATM/ANS.AR.C.020(c) Issue of certificates	109
ATM/ANS.AR.C.025 Changes.....	109
AMC1 ATM/ANS.AR.C.025(b) Changes	110
AMC2 ATM/ANS.AR.C.025(b) Changes	110
GM1 ATM/ANS.AR.C.025(b) Changes	111
GM2 ATM/ANS.AR.C.025(b) Changes	111
AMC1 ATM/ANS.AR.C.025(c) Changes.....	111
ATM/ANS.AR.C.030 Approval of change management procedures for functional systems	111
GM1 ATM/ANS.AR.C.030 Approval of change management procedures for functional systems	111
AMC1 ATM/ANS.AR.C.030(a) Approval of change management procedures for functional systems	112
AMC1 ATM/ANS.AR.C.030(b) Approval of change management procedures for functional systems	112
GM1 ATM/ANS.AR.C.030(b) Approval of change management procedures for functional systems	113
ATM/ANS.AR.C.035 Decision to review a notified change to the functional system	113
AMC1 ATM/ANS.AR.C.035(a) Decision to review a notified change to the functional system	113
GM1 ATM/ANS.AR.C.035(b) Decision to review a notified change to the functional system	113
GM1 ATM/ANS.AR.C.035(c) Decision to review a notified change to the functional system	115
ATM/ANS.AR.C.040 Review of a notified change to the functional system	117
ATM/ANS.AR.C.045 Declarations of flight information services providers.....	117

ATM/ANS.AR.C.050 Findings, corrective actions, and enforcement measures	117
GM1 ATM/ANS.AR.C.050 Findings, corrective actions, and enforcement measures	119
GM2 ATM/ANS.AR.C.050 Findings, corrective actions, and enforcement measures	119
AMC1 ATM/ANS.AR.C.050(e) Findings, corrective actions, and enforcement measures	119
GM1 ATM/ANS.AR.C.050(e) Findings, corrective actions, and enforcement measures	120
GM1 ATM/ANS.AR.C.050(f) Findings, corrective actions, and enforcement measures	120
APPENDICES TO ANNEX II	121
Appendix 1 — EASA Form 157.....	121
ANNEX III — Part-ATM/ANS.OR.....	125
SUBPART A — GENERAL REQUIREMENTS (ATM/ANS.OR.A)	125
ATM/ANS.OR.A.001 Scope	125
GM1 ATM/ANS.OR.A.001 Scope	125
ATM/ANS.OR.A.005 Application for a service provider certificate	130
AMC1 ATM/ANS.OR.A.005 Application for a service provider certificate	130
GM1 to AMC1 ATM/ANS.OR.A.005 Application for a service provider certificate.....	131
GM2 to AMC1 ATM/ANS.OR.A.005 Application for a service provider certificate.....	131
GM3 ATM/ANS.OR.A.005 Application for a service provider certificate.....	132
ATM/ANS.OR.A.010 Application for a limited certificate.....	132
GM1 ATM/ANS.OR.A.010 Application for a limited certificate.....	133
ATM/ANS.OR.A.015 Declaration by flight information services providers	133
GM1 ATM/ANS.OR.A.015(b)(1) Declaration by flight information services providers	135
ATM/ANS.OR.A.020 Means of compliance	136
ATM/ANS.OR.A.025 Continued validity of a certificate	136
ATM/ANS.OR.A.030 Continued validity of a declaration of a flight information services provider	136
ATM/ANS.OR.A.035 Demonstration of compliance	136
AMC1 ATM/ANS.OR.A.035 Demonstration of compliance.....	137
GM1 ATM/ANS.OR.A.035 Demonstration of compliance.....	137
GM2 ATM/ANS.OR.A.035 Demonstration of compliance.....	137
ATM/ANS.OR.A.040 Changes — general.....	137
AMC1 ATM/ANS.OR.A.040 Changes — general.....	137
AMC1 ATM/ANS.OR.A.040(b) Changes — general	138
AMC2 ATM/ANS.OR.A.040(b) Changes — general	138
GM1 ATM/ANS.OR.A.040(b) Changes — general	138
ATM/ANS.OR.A.045 Changes to a functional system.....	138
AMC1 ATM/ANS.OR.A.045(a) Changes to a functional system	139
GM1 ATM/ANS.OR.A.045(a) Changes to a functional system	140

GM2 ATM/ANS.OR.A.045(a) Changes to a functional system	141
AMC1 ATM/ANS.OR.A.045(a)(3) Changes to a functional system.....	141
GM1 ATM/ANS.OR.A.045(a)(3) Changes to a functional system.....	142
AMC1 ATM/ANS.OR.A.045(b) Changes to a functional system	142
AMC1 ATM/ANS.OR.A.045(c); (d) Changes to a functional system.....	142
GM1 ATM/ANS.OR.A.045(c); (d) Changes to a functional system.....	142
AMC1 ATM/ANS.OR.A.045(e) Changes to the functional system.....	143
GM1 ATM/ANS.OR.A.045(e) Changes to the functional system.....	143
GM2 ATM/ANS.OR.A.045(e) Changes to the functional system.....	144
GM3 ATM/ANS.OR.A.045(e) Changes to the functional system.....	144
GM4 ATM/ANS.OR.A.045(e) Changes to a functional system	145
GM1 ATM/ANS.OR.A.045(e)(2) Changes to a functional system.....	145
GM1 ATM/ANS.OR.A.045(f) Changes to a functional system.....	146
ATM/ANS.OR.A.050 Facilitation and cooperation	146
GM1 ATM/ANS.OR.A.050 Facilitation and cooperation	146
ATM/ANS.OR.A.055 Findings and corrective actions.....	147
GM1 ATM/ANS.OR.A.055 Findings and corrective actions.....	147
AMC1 ATM/ANS.OR.A.055(b) Findings and corrective actions	147
AMC1 ATM/ANS.OR.A.055(c) Findings and corrective actions.....	147
ATM/ANS.OR.A.060 Immediate reaction to a safety problem.....	147
ATM/ANS.OR.A.065 Occurrence reporting	147
AMC1 ATM/ANS.OR.A.065 Occurrence reporting	148
AMC2 ATM/ANS.OR.A.065 Occurrence reporting	149
AMC3 ATM/ANS.OR.A.065 Occurrence reporting	149
AMC1 ATM/ANS.OR.A.065(c) Occurrence reporting	150
GM1 ATM/ANS.OR.A.065(c) Occurrence reporting.....	150
AMC1 ATM/ANS.OR.A.065(e) Occurrence reporting.....	151
ATM/ANS.OR.A.070 Contingency plans	153
GM1 ATM/ANS.OR.A.070 Contingency plans	153
ATM/ANS.OR.A.075 Open and transparent provision of services	153
AMC1 ATM/ANS.OR.A.075(a) Open and transparent provision of services.....	153
ATM/ANS.OR.A.080 Provision of aeronautical data	154
ATM/ANS.OR.A.085 Aeronautical data quality management.....	154
GM1 ATM/ANS.OR.085 Aeronautical data quality management.....	155
GM1 ATM/ANS.OR.A.085(a) Aeronautical data quality management	156
GM1 ATM/ANS.OR.A.085(b) Aeronautical data quality management	156
GM1 ATM/ANS.OR.A.085(b)(4) Aeronautical data quality management.....	156
GM1 ATM/ANS.OR.A.085(b)(5) Aeronautical data quality management.....	156
AMC1 ATM/ANS.OR.A.085(b)(8) Aeronautical data quality management.....	157
AMC1 ATM/ANS.OR.A.085(d) Aeronautical data quality management	157
GM1 ATM/ANS.OR.A.085(d) Aeronautical data quality management	157
GM2 ATM/ANS.OR.A.085(d) Aeronautical data quality management	158
GM1 ATM/ANS.OR.A.085(e) Aeronautical data quality management	159
AMC1 ATM/ANS.OR.A.085(f) Aeronautical data quality management	159
GM1 ATM/ANS.OR.A.085(f) Aeronautical data quality management.....	159
GM1 ATM/ANS.OR.A.085(i) Aeronautical data quality management	160
GM2 ATM/ANS.OR.A.085(i) Aeronautical data quality management	160

GM1 ATM/ANS.OR.A.085(j) Aeronautical data quality management	160
GM2 ATM/ANS.OR.A.085(j) Aeronautical data quality management	161
GM1 ATM/ANS.OR.A.085(l) Aeronautical data quality management	161
ATM/ANS.OR.A.090 Common reference systems for air navigation	161
GM1 ATM/ANS.OR.A.090(a) Common reference systems for air navigation	161
GM2 ATM/ANS.OR.A.090(a) Common reference systems for air navigation.....	162
AMC1 ATM/ANS.OR.A.090(b) Common reference systems for air navigation ...	162
GM1 ATM/ANS.OR.A.090(b) Common reference systems for air navigation	162
GM2 ATM/ANS.OR.A.090(b) Common reference systems for air navigation	163
GM1 ATM/ANS.OR.A.090(c) Common reference systems for air navigation	163
SUBPART B — MANAGEMENT (ATM/ANS.OR.B).....	164
ATM/ANS.OR.B.001 Technical and operational competence and capability.....	164
GM1 ATM/ANS.OR.B.001 Technical and operational competence and capability	164
ATM/ANS.OR.B.005 Management system	164
GM1 ATM/ANS.OR.B.005 Management system	165
GM2 ATM/ANS.OR.B.005 Management system.....	165
AMC1 ATM/ANS.OR.B.005(a) Management system.....	166
GM1 to AMC1 ATM/ANS.OR.B.005(a) Management system	166
GM2 to AMC1 ATM/ANS.OR.B.005(a) Management system	167
AMC2 ATM/ANS.OR.B.005(a) Management system.....	167
GM1 to AMC2 ATM/ANS.OR.B.005(a) Management system	167
AMC3 ATM/ANS.OR.B.005(a) Management system.....	167
GM1 to AMC3 ATM/ANS.OR.B.005(a) Management system	167
AMC4 ATM/ANS.OR.B.005(a) Management system.....	168
GM1 ATM/ANS.OR.B.005(a)(1) Management system	168
AMC1 ATM/ANS.OR.B.005(a)(2) Management system	168
GM1 ATM/ANS.OR.B.005(a)(2) Management system	169
GM2 ATM/ANS.OR.B.005(a)(2) Management system	169
GM3 ATM/ANS.OR.B.005(a)(2) Management system	170
AMC1 ATM/ANS.OR.B.005(a)(3) Management system	170
AMC2 ATM/ANS.OR.B.005(a)(3) Management system	170
GM1 to AMC2 ATM/ANS.OR.B.005(a)(3) Management system	171
GM1 ATM/ANS.OR.B.005(a)(3) Management system	172
GM2 ATM/ANS.OR.B.005(a)(3) Management system	174
GM1 ATM/ANS.OR.B.005(a)(4) Management system	174
AMC1 ATM/ANS.OR.B.005(a)(5) Management system	175
AMC1 ATM/ANS.OR.B.005(a)(6) Management system	176
GM1 ATM/ANS.OR.B.005(a)(6) Management system	176
AMC1 ATM/ANS.OR.B.005(a)(7) Management system	176
AMC1 ATM/ANS.OR.B.005(b) Management system	176
GM1 ATM/ANS.OR.B.005(b) Management system	177
AMC1 ATM/ANS.OR.B.005(c) Management system.....	177
GM1 ATM/ANS.OR.B.005(c) Management system.....	179
AMC1 ATM/ANS.OR.B.005(d) Management system	180
AMC1 ATM/ANS.OR.B.005(e) Management system.....	180
GM1 ATM/ANS.OR.B.005(e) Management system	180
GM1 ATM/ANS.OR.B.005(f) Management system	181
GM2 ATM/ANS.OR.B.005(f) Management system	181

ATM/ANS.OR.B.010 Change management procedures	181
AMC1 ATM/ANS.OR.B.010(a) Change management procedures.....	182
GM1 to AMC1 ATM/ANS.OR.B.010(a) Change management procedures	182
AMC2 ATM/ANS.OR.B.010(a) Change management procedures.....	183
GM1 ATM/ANS.OR.B.010(a) Change management procedures.....	184
ATM/ANS.OR.B.015 Contracted activities.....	185
AMC1 ATM/ANS.OR.B.015 Contracted activities.....	185
GM1 to AMC1 ATM/ANS.OR.B.015 Contracted activities	185
AMC2 ATM/ANS.OR.B.015 Contracted activities.....	186
AMC3 ATM/ANS.OR.B.015 Contracted activities.....	186
GM1 ATM/ANS.OR.B.015 Contracted activities.....	186
GM2 ATM/ANS.OR.B.015 Contracted activities.....	186
GM3 ATM/ANS.OR.B.015 Contracted activities.....	187
GM4 ATM/ANS.OR.B.015 Contracted activities.....	187
ATM/ANS.OR.B.020 Personnel requirements.....	187
GM1 ATM/ANS.OR.B.020(a) Personnel requirements.....	188
AMC1 ATM/ANS.OR.B.020(b) Personnel requirements	188
GM1 ATM/ANS.OR.B.020(b) Personnel requirements	188
ATM/ANS.OR.B.025 Facilities requirements	188
ATM/ANS.OR.B.030 Record-keeping.....	189
AMC1 ATM/ANS.OR.B.030 Record-keeping.....	189
GM1 ATM/ANS.OR.B.030 Record-keeping.....	189
AMC1 ATM/ANS.OR.B.030(b) Record-keeping	189
ATM/ANS.OR.B.035 Operations manuals	190
SUBPART C — SPECIFIC ORGANISATION REQUIREMENTS FOR SERVICE PROVIDERS OTHER THAN ATS PROVIDERS (ATM/ANS.OR.C).....	191
ATM/ANS.OR.C.001 Scope	191
ATM/ANS.OR.C.005 Safety support assessment and assurance of changes to the functional system	191
GM1 ATM/ANS.OR.C.005(a)(1) Safety support assessment and assurance of changes to the functional system	192
GM2 ATM/ANS.OR.C.005(a)(1) Safety support assessment and assurance of changes to the functional system	192
GM3 ATM/ANS.OR.C.005(a)(1) Safety support assessment and assurance of changes to the functional system	192
GM4 ATM/ANS.OR.C.005(a)(1) Safety support assessment and assurance of changes to the functional system	193
GM5 ATM/ANS.OR.C.005(a)(1) Safety support assessment and assurance of changes to the functional system	194
GM6 ATM/ANS.OR.C.005(a)(1) Safety support assessment and assurance of changes to the functional system	194
AMC1 ATM/ANS.OR.C.005(a)(2) Safety support assessment and assurance of changes to the functional system	194
AMC2 ATM/ANS.OR.C.005(a)(2) Safety support assessment and assurance of changes to the functional system	195
GM1 to AMC2 ATM/ANS.OR.C.005(a)(2) Safety support assessment and assurance of changes to the functional system	195

AMC3 ATM/ANS.OR.C.005(a)(2) Safety support assessment and assurance of changes to the functional system	199
AMC4 ATM/ANS.OR.C.005(a)(2) Safety support assessment and assurance of changes to the functional system	200
AMC5 ATM/ANS.OR.C.005(a)(2) Safety support assessment and assurance of changes to the functional system	200
AMC6 ATM/ANS.OR.C.005(a)(2) Safety support assessment and assurance of changes to the functional system	200
GM1 to AMC6 ATM/ANS.OR.C.005(a)(2) Safety support assessment and assurance of changes to the functional system	202
GM2 to AMC6 ATM/ANS.OR.C.005(a)(2) Safety support assessment and assurance of changes to the functional system	203
GM3 to AMC6 ATM/ANS.OR.C.005(a)(2) Safety support assessment and assurance of changes to the functional system	203
GM4 to AMC6 ATM/ANS.OR.C.005(a)(2) Safety support assessment and assurance of changes to the functional system	204
GM1 ATM/ANS.OR.C.005(a)(2) Safety support assessment and assurance of changes to the functional system	205
GM2 ATM/ANS.OR.C.005(a)(2) Safety support assessment and assurance of changes to the functional system	205
GM3 ATM/ANS.OR.C.005(a)(2) Safety support assessment and assurance of changes to the functional system	206
AMC1 ATM/ANS.OR.C.005(b)(1) Safety support assessment and assurance of changes to the functional system	206
GM1 ATM/ANS.OR.C.005(b)(1) Safety support assessment and assurance of changes to the functional system	207
GM2 ATM/ANS.OR.C.005(b)(1) Safety support assessment and assurance of changes to the functional system	207
AMC1 ATM/ANS.OR.C.005(b)(2) Safety support assessment and assurance of changes to the functional system	208
GM1 ATM/ANS.OR.C.005(b)(2) Safety support assessment and assurance of changes to the functional system	208
SUBPART D — SPECIFIC ORGANISATIONAL REQUIREMENTS FOR ANS AND ATFM PROVIDERS AND THE NETWORK MANAGER (ATM/ANS.OR.D)	209
ATM/ANS.OR.D.001 Scope	209
ATM/ANS.OR.D.005 Business, annual, and performance plans.....	209
ATM/ANS.OR.D.010 Security management	210
GM1 ATM/ANS.OR.D.010(d) Security management.....	211
ATM/ANS.OR.D.015 Financial strength — economic and financial capacity	211
ATM/ANS.OR.D.020 Liability and insurance cover	211
ATM/ANS.OR.D.025 Reporting requirements	211
APPENDICES TO ANNEX III	212
Appendix 1 AERONAUTICAL DATA CATALOGUE	212

ANNEX IV — Part-ATS 360**SUBPART A — ADDITIONAL ORGANISATION REQUIREMENTS FOR PROVIDERS OF AIR
TRAFFIC SERVICES (ATS.OR) 360**

SECTION 1 — GENERAL REQUIREMENTS	360
GM1 Annex IV (Part-ATS)	360
ATS.OR.100 Ownership	364
ATS.OR.105 Open and transparent provision of service.....	364
ATS.OR.110 Coordination between aerodrome operators and air traffic services providers	364
AMC1 ATS.OR.110 Coordination between aerodrome operators and air traffic services providers	364
AMC2 ATS.OR.110 Coordination between aerodrome operators and air traffic services providers	365
AMC3 ATS.OR.110 Coordination between aerodrome operators and air traffic services providers	365
AMC4 ATS.OR.110 Coordination between aerodrome operators and air traffic services providers	365
AMC5 ATS.OR.110 Coordination between aerodrome operators and air traffic services providers	366
AMC6 ATS.OR.110 Coordination between aerodrome operators and air traffic services providers	366
GM1 ATS.OR.110 Coordination between aerodrome operators and air traffic services providers	366
ATS.OR.115 Coordination between military units and air traffic services providers	366
ATS.OR.120 Coordination between meteorological services providers and air traffic services providers.....	367
ATS.OR.125 Coordination between aeronautical information services and air traffic services providers.....	367
GM1 ATS.OR.125(a) Coordination between aeronautical information services and air traffic services providers	368
GM2 ATS.OR.125(a) Coordination between aeronautical information services and air traffic services providers	368
GM1 ATS.OR.125(c) Coordination between aeronautical information services and air traffic services providers	369
GM1 ATS.OR.125(d) Coordination between aeronautical information services and air traffic services providers	369
ATS.OR.127 Coordination by air traffic services providers in U-space airspace ..	369
AMC1 ATS.OR.127(a) Coordination by air traffic services providers in U-space airspace ..	369
ATS.OR.130 Time in air traffic services	370
ATS.OR.135 Contingency arrangements	370
GM1 ATS.OR.135 Contingency arrangements	370
GM2 ATS.OR.135 Contingency arrangements	370
GM3 ATS.OR.135 Contingency arrangements	372
GM4 ATS.OR.135 Contingency arrangements	372
ATS.OR.140 Failure and irregularity of systems and equipment	372
GM1 ATS.OR.140 Failure and irregularity of systems and equipment	373
ATS.OR.145 Operation of air traffic control service.....	373
AMC1 ATS.OR.145 Operation of air traffic control service	373
GM1 ATS.OR.145 Operation of air traffic control	374
GM2 ATS.OR.145 Operation of air traffic control service	374
GM3 ATS.OR.145 Operation of air traffic control service	374
ATS.OR.150 Transfer of responsibility for control and transfer of communications	375
GM1 ATS.OR.150 Transfer of responsibility for control and transfer of communications...	375

GM2 ATS.OR.150 Transfer of responsibility for control and transfer of communications...	375
SECTION 2 — SAFETY OF SERVICES	377
ATS.OR.200 Safety management system	377
AMC1 ATS.OR.200(1); (2); (3) Safety management system	378
AMC1 ATS.OR.200(1)(i) Safety management system	378
GM1 ATS.OR.200(1)(i) Safety management system	379
GM2 ATS.OR.200(1)(i) Safety management system	379
GM3 ATS.OR.200(1)(i) Safety management system	379
AMC1 ATS.OR.200(1)(ii) Safety management system	379
GM1 ATS.OR.200(1)(ii) Safety management system	380
AMC1 ATS.OR.200(1)(ii);(iii) Safety management system	380
AMC2 ATS.OR.200(1)(ii);(iii) Safety management system	381
GM1 ATS.OR.200(1)(iii) Safety management system	382
GM2 ATS.OR.200(1)(iii) Safety management system	382
AMC1 ATS.OR.200(1)(iv) Safety management system	382
GM1 ATS.OR.200(1)(iv) Safety management system	382
GM2 ATS.OR.200(1)(iv) Safety management system	383
AMC1 ATS.OR.200(1)(v) Safety management system	383
AMC2 ATS.OR.200(1)(v) Safety management system	383
GM1 ATS.OR.200(1)(v) Safety management system	384
GM1 ATS.OR.200(3)(i) Safety management system	384
AMC1 ATS.OR.200(3)(iii) Safety management system	386
GM1 ATS.OR.200(3)(iii) Safety management system	386
AMC1 ATS.OR.200(4)(i) Safety management system	387
GM1 ATS.OR.200(4)(i) Safety management system	388
ATS.OR.205 Safety assessment and assurance of changes to the functional system	388
GM1 ATS.OR.205(a)(1) Safety assessment and assurance of changes to the functional system	389
GM2 ATS.OR.205(a)(1) Safety assessment and assurance of changes to the functional system	389
GM3 ATS.OR.205(a)(1) Safety assessment and assurance of changes to the functional system	390
GM4 ATS.OR.205(a)(1) Safety assessment and assurance of changes to the functional system	390
GM1 ATS.OR.205(a)(1)(iii) Safety assessment and assurance of changes to the functional system	391
AMC1 ATS.OR.205(a)(2) Safety assessment and assurance of changes to the functional system	391
AMC2 ATS.OR.205(a)(2) Safety assessment and assurance of changes to the functional system	391
GM1 to AMC2 ATS.OR.205(a)(2) Safety assessment and assurance of changes to the functional system	392
AMC3 ATS.OR.205(a)(2) Safety assessment and assurance of changes to the functional system	395
AMC4 ATS.OR.205(a)(2) Safety assessment and assurance of changes to the functional system	395
GM1 to AMC4 ATS.OR.205(a)(2) Safety assessment and assurance of changes to the functional system	397
GM2 to AMC4 ATS.OR.205(a)(2) Safety assessment and assurance of changes to the functional system	397
GM3 to AMC4 ATS.OR.205(a)(2) Safety assessment and assurance of changes to the functional system	398
GM4 to AMC4 ATS.OR.205(a)(2) Safety assessment and assurance of changes to the functional system	398
GM5 to AMC4 ATS.OR.205(a)(2) Safety assessment and assurance of changes to the functional system	399
GM1 ATS.OR.205(a)(2) Safety assessment and assurance of changes to the functional system	400
GM2 ATS.OR.205(a)(2) Safety assessment and assurance of changes to the functional system	400

GM3 ATS.OR.205(a)(2) Safety assessment and assurance of changes to the functional system	400
GM1 ATS.OR.205(b) Safety assessment and assurance of changes to the functional system	401
AMC1 ATS.OR.205(b)(1) Safety assessment and assurance of changes to the functional system	401
AMC2 ATS.OR.205(b)(1) Safety assessment and assurance of changes to the functional system	401
GM1 ATS.OR.205(b)(1) Safety assessment and assurance of changes to the functional system	402
AMC1 ATS.OR.205(b)(2) Safety assessment and assurance of changes to the functional system	403
AMC1 ATS.OR.205(b)(3) Safety assessment and assurance of changes to the functional system	404
AMC2 ATS.OR.205(b)(3) Safety assessment and assurance of changes to the functional system	404
AMC1 ATS.OR.205(b)(4) Safety assessment and assurance of changes to the functional system	405
GM1 to AMC1 ATS.OR.205(b)(4) Safety assessment and assurance of changes to the functional system.....	405
AMC2 ATS.OR.205(b)(4) Safety assessment and assurance of changes to the functional system	411
GM1 ATS.OR.205(b)(4) Safety assessment and assurance of changes to the functional system	411
AMC1 ATS.OR.205(b)(5) Safety assessment and assurance of changes to the functional system	413
GM1 ATS.OR.205(b)(5) Safety assessment and assurance of changes to the functional system	413
GM2 ATS.OR.205(b)(5) Safety assessment and assurance of changes to the functional system	414
GM3 ATS.OR.205(b)(5) Safety assessment and assurance of changes to the functional system	414
GM4 ATS.OR.205(b)(5) Safety assessment and assurance of changes to the functional system	414
GM1 ATS.OR.205(b)(5)(ii) Safety assessment and assurance of changes to the functional system	415
AMC1 ATS.OR.205(b)(6) Safety assessment and assurance of changes to the functional system	415
GM1 ATS.OR.205(b)(6) Safety assessment and assurance of changes to the functional system	415
ATS.OR.210 Safety criteria	416
AMC1 ATS.OR.210(a) Safety criteria	416
AMC2 ATS.OR.210(a) Safety criteria	416
GM1 ATS.OR.210(a) Safety criteria	417
ATS.OR.215 Licensing and medical certification requirements for air traffic controllers	418
SECTION 3 — SPECIFIC HUMAN FACTORS REQUIREMENTS FOR AIR TRAFFIC CONTROL SERVICE PROVIDERS	419
ATS.OR.300 Scope	419
ATS.OR.305 Responsibilities of air traffic control service providers with regard to the problematic use of psychoactive substances by air traffic controllers	419
AMC1 ATS.OR.305(a) Responsibilities of air traffic control service providers with regard to the problematic use of psychoactive substances by air traffic controllers	419
GM1 ATS.OR.305(a) Responsibilities of air traffic control service providers with regard to the problematic use of psychoactive substances by air traffic controllers	420
GM2 ATS.OR.305(a) Responsibilities of air traffic control service providers with regard to the problematic use of psychoactive substances by air traffic controllers	421
AMC1 ATS.OR.305(b) Responsibilities of air traffic control service providers with regard to the problematic use of psychoactive substances by air traffic controllers	421

GM1 ATS.OR.305(b) Responsibilities of air traffic control service providers with regard to the problematic use of psychoactive substances by air traffic controllers	421
ATS.OR.310 Stress	422
GM1 ATS.OR.310 Stress	422
AMC1 ATS.OR.310(a) Stress	427
GM1 ATS.OR.310(a) Stress	428
GM1 ATS.OR.310(b) Stress	428
ATS.OR.315 Fatigue	428
GM1 ATS.OR.315 Fatigue	428
AMC1 ATS.OR.315(a) Fatigue	428
GM1 to AMC1 ATS.OR.315(a) Fatigue	429
GM2 to AMC1 ATS.OR.315(a) Fatigue	429
GM3 to AMC1 ATS.OR.315(a) Fatigue	429
GM1 ATS.OR.315(b) Fatigue	430
GM2 ATS.OR.315(b) Fatigue	431
ATS.OR.320 Air traffic controllers' rostering system(s)	431
GM1 ATS.OR.320(a) Air traffic controllers' rostering system(s)	431
AMC1 ATS.OR.320(a)(6);(7) Air traffic controllers' rostering system(s)	432
GM1 ATS.OR.320(b) Air traffic controllers' rostering system(s)	432
SECTION 4 - REQUIREMENTS FOR COMMUNICATIONS	433
ATS.OR.400 Aeronautical mobile service (air-ground communications) – general	433
GM1 ATS.OR.400(a) Aeronautical mobile service (air-ground communications) – general	433
ATS.OR.405 Use and availability of the VHF emergency frequency	433
GM1 ATS.OR.405 Use and availability of the VHF emergency frequency	434
GM1 ATS.OR.405(a)(3) Use and availability of the VHF emergency frequency	434
GM1 ATS.OR.405(b) Use and availability of the VHF emergency frequency	434
ATS.OR.410 Aeronautical mobile service (air-ground communications) – flight information service	435
GM1 ATS.OR.410(a) Aeronautical mobile service (air-ground communications) – flight information service	435
ATS.OR.415 Aeronautical mobile service (air-ground communications) – area control service	435
AMC1 ATS.OR.415 Aeronautical mobile service (air-ground communications) – area control service	435
GM1 ATS.OR.415 Aeronautical mobile service (air-ground communications) – area control service	435
ATS.OR.420 Aeronautical mobile service (air-ground communications) – approach control service	436
ATS.OR.425 Aeronautical mobile service (air-ground communications) – aerodrome control service	436
GM1 ATS.OR.425(b) Aeronautical mobile service (air-ground communications) – aerodrome control service	436
ATS.OR.430 Aeronautical fixed service (ground-ground communications) – general	436
GM1 ATS.OR.430(a) Aeronautical fixed service (ground-ground communications) – general	437
GM1 ATS.OR.430(b) Aeronautical fixed service (ground-ground communications) – general	437
ATS.OR.435 Aeronautical fixed service (ground-ground communications) – communication within a flight information region	437
GM1 ATS.OR.435(a) Aeronautical fixed service (ground-ground communications) – communication within a flight information region	439
GM1 ATS.OR.435(a);(b) Aeronautical fixed service (ground-ground communications) – communication within a flight information region	440

GM1 ATS.OR.435(c)(4) Aeronautical fixed service (ground-ground communications) – communication within a flight information region	440
ATS.OR.440 Aeronautical fixed service (ground-ground communications) – communication between flight information regions.....	440
GM1 ATS.OR.440(d) Aeronautical fixed service (ground-ground communications) – communication between flight information regions	441
ATS.OR.445 Communications for the control or management of vehicles other than aircraft on manoeuvring areas at aerodromes	441
GM1 ATS.OR.445(a) Communications for the control or management of vehicles other than aircraft on manoeuvring areas at aerodromes	442
ATS.OR.450 Automatic recording of surveillance data	442
GM1 ATS.OR.450 Automatic recording of surveillance data.....	442
ATS.OR.455 Retention of recorded information and data.....	443
ATS.OR.460 Background communication and aural environment recording.....	443
SECTION 5 – REQUIREMENTS FOR INFORMATION	444
ATS.OR.500 Meteorological information – General	444
ATS.OR.505 Meteorological information for flight information centres and area control centres	444
GM1 ATS.OR.505(a) Meteorological information for flight information centres and area control centres.....	444
ATS.OR.510 Meteorological information for units providing approach control service	445
ATS.OR.515 Meteorological information for aerodrome control towers and AFIS units.....	445
ATS.OR.520 Information on aerodrome conditions and the operational status of associated facilities	446
ATS.OR.525 Information on the operational status of navigation services.....	446
GM1 ATS.OR.525(a) Information on the operational status of navigation services	447
AMC1 ATS.OR.525(b) Information on the operational status of navigation services	447
GM1 ATS.OR.525(b) Information on the operational status of navigation services	447
ATS.OR.530 Forwarding of braking action information	447
SUBPART B — TECHNICAL REQUIREMENTS FOR PROVIDERS OF AIR TRAFFIC SERVICES (ATS.TR)	448
SECTION 1 — GENERAL REQUIREMENTS	448
ATS.TR.100 Objectives of the air traffic services (ATS)	448
ATS.TR.105 Divisions of the air traffic services	448
AMC1 ATS.TR.105(b) Divisions of the air traffic services	448
AMC2 ATS.TR.105(b) Divisions of the air traffic services	449
GM1 ATS.TR.105(b) Divisions of the air traffic services	449
ATS.TR.110 Establishment of the units providing air traffic services	450
GM1 ATS.TR.110(b) Establishment of the units providing air traffic services.....	450
ATS.TR.115 Identification of air traffic services units	450
GM1 ATS.TR.115(b)(9);(10) Identification of air traffic services units.....	451
ATS.TR.120 Language for communication between air traffic services units.....	451
ATS.TR.125 Expression of vertical position of aircraft	452
ATS.TR.130 Determination of the transition level	452
GM1 ATS.TR.130 Determination of the transition level.....	452
GM1 ATS.TR.130(b) Determination of the transition level	452
ATS.TR.135 Minimum cruising level for IFR flights	454
GM1 ATS.TR.135(b) Minimum cruising level for IFR flights.....	454
ATS.TR.140 Provision of altimeter setting information	454
GM1 ATS.TR.140(c) Provision of altimeter setting information.....	455
GM2 ATS.TR.140(c) Provision of altimeter setting information.....	455

ATS.TR.145 Suspension of visual flight rules operations on and in the vicinity of an aerodrome	455
GM1 ATS.TR.145 Suspension of visual flight rules operations on and in the vicinity of an aerodrome	456
ATS.TR.150 Aeronautical ground lights.....	456
AMC1 ATS.TR.150 Aeronautical ground lights	456
GM1 to AMC1 ATS.TR.150 Aeronautical ground lights	457
ATS.TR.155 ATS surveillance services	458
GM1 ATS.TR.155 ATS surveillance services	459
AMC1 ATS.TR.155(a) ATS surveillance services	460
GM1 ATS.TR.155(a) ATS surveillance services.....	461
GM1 ATS.TR.155(b)(1) ATS surveillance services	462
GM2 ATS.TR.155(b)(1) ATS surveillance services	462
AMC1 ATS.TR.155(b)(2)(i) ATS surveillance services	462
AMC1 ATS.TR.155(c)(1) ATS surveillance services.....	462
AMC2 ATS.TR.155(c)(1) ATS surveillance services.....	464
AMC3 ATS.TR.155(c)(1) ATS surveillance services.....	464
GM1 to AMC3 ATS.TR.155(c)(1) ATS surveillance services.....	465
GM1 ATS.TR.155(c)(1) ATS surveillance services	466
GM2 ATS.TR.155(c)(1) ATS surveillance services	466
AMC1 ATS.TR.155(c)(2) ATS surveillance services.....	466
AMC1 ATS.TR.155(c)(3) ATS surveillance services.....	467
GM1 to AMC1 ATS.TR.155(c)(3) ATS surveillance services.....	468
GM2 to AMC1 ATS.TR.155(c)(3) ATS surveillance services.....	468
GM3 to AMC1 ATS.TR.155(c)(3) ATS surveillance services.....	468
AMC2 ATS.TR.155(c)(3) ATS surveillance services.....	469
GM1 to AMC2 ATS.TR.155(c)(3) ATS surveillance services.....	469
GM2 to AMC2 ATS.TR.155(c)(3) ATS surveillance services.....	470
GM3 to AMC2 ATS.TR.155(c)(3) ATS surveillance services.....	471
GM1 ATS.TR.155(c)(3) ATS surveillance services	472
AMC1 ATS.TR.155(c)(4) ATS surveillance services.....	472
GM1 ATS.TR.155(c)(5) ATS surveillance services	473
AMC1 ATS.TR.155(c)(6) ATS surveillance services.....	473
GM1 to AMC1 ATS.TR.155(c)(6) ATS surveillance services.....	474
GM1 ATS.TR.155(c)(6) ATS surveillance services	475
GM1 ATS.TR.155(c)(7) ATS surveillance services	475
GM2 ATS.TR.155(c)(7) ATS surveillance services	475
GM3 ATS.TR.155(c)(7) ATS surveillance services	475
GM1 ATS.TR.155(c)(9) ATS surveillance services	475
GM2 ATS.TR.155(c)(9) ATS surveillance services	476
GM3 ATS.TR.155(c)(9) ATS surveillance services	476
AMC1 ATS.TR.155(c)(10) ATS surveillance services	476
AMC1 ATS.TR.155(e) ATS surveillance services.....	477
GM1 to AMC1 ATS.TR.155(e) ATS surveillance services.....	477
GM2 to AMC1 ATS.TR.155(e) ATS surveillance services.....	477
AMC1 ATS.TR.155(f) ATS surveillance services	477
AMC2 ATS.TR.155(f) ATS surveillance services	478
GM1 ATS.TR.155(f) ATS surveillance services	478
GM2 ATS.TR.155(f) ATS surveillance services	478
AMC1 ATS.TR.155(g) ATS surveillance services.....	478
ATS.TR.160 Provision of air traffic services for flight testing	479
GM1 ATS.TR.160 Provision of air traffic services for flight testing.....	479
SECTION 2 - AIR TRAFFIC CONTROL SERVICE	481
ATS.TR.200 Application	481
ATS.TR.205 Provision of air traffic control service	481
AMC1 ATS.TR.205 Provision of air traffic control service.....	481
GM1 ATS.TR.205 Provision of air traffic control service	482
AMC1 ATS.TR.205(c) Provision of air traffic control service	482
GM1 to AMC1 ATS.TR.205(c) Provision of air traffic control service.....	482
GM1 ATS.TR.205(c) Provision of air traffic control service	483

ATS.TR.210 Operation of air traffic control service	483
AMC1 ATS.TR.210(a)(3) Operation of air traffic control service	484
GM1 to AMC1 ATS.TR.210(a)(3) Operation of air traffic control service.....	485
GM2 to AMC1 ATS.TR.210(a)(3) Operation of air traffic control service.....	485
GM3 to AMC1 ATS.TR.210(a)(3) Operation of air traffic control service.....	485
AMC2 ATS.TR.210(a)(3) Operation of air traffic control service	486
GM1 to AMC2 ATS.TR.210(a)(3) Operation of air traffic control service.....	486
AMC3 ATS.TR.210(a)(3) Operation of air traffic control service	486
GM1 to AMC3 ATS.TR.210(a)(3) Operation of air traffic control service.....	487
AMC4 ATS.TR.210(a)(3) Operation of air traffic control service	487
GM1 to AMC4 ATS.TR.210(a)(3) Operation of air traffic control service.....	487
AMC5 ATS.TR.210(a)(3) Operation of air traffic control service	488
GM1 to AMC5 ATS.TR.210(a)(3) Operation of air traffic control service.....	488
AMC6 ATS.TR.210(a)(3) Operation of air traffic control service	489
AMC7 ATS.TR.210(a)(3) Operation of air traffic control service	490
AMC8 ATS.TR.210(a)(3) Operation of air traffic control service	490
GM1 to AMC8 ATS.TR.210(a)(3) Operation of air traffic control service.....	490
AMC9 ATS.TR.210(a)(3) Operation of air traffic control service	490
GM1 to AMC9 ATS.TR.210(a)(3) Operation of air traffic control service.....	491
AMC10 ATS.TR.210(a)(3) Operation of air traffic control service	491
GM1 to AMC10 ATS.TR.210(a)(3) Operation of air traffic control service.....	492
AMC11 ATS.TR.210(a)(3) Operation of air traffic control service	493
AMC12 ATS.TR.210(a)(3) Operation of air traffic control service	493
GM1 to AMC12 ATS.TR.210(a)(3) Operation of air traffic control service.....	494
AMC13 ATS.TR.210(a)(3) Operation of air traffic control service	494
GM1 to AMC13 ATS.TR.210(a)(3) Operation of air traffic control service.....	494
GM2 to AMC13 ATS.TR.210(a)(3) Operation of air traffic control service.....	495
GM3 to AMC13 ATS.TR.210(a)(3) Operation of air traffic control service.....	495
AMC14 ATS.TR.210(a)(3) Operation of air traffic control service	495
AMC15 ATS.TR.210(a)(3) Operation of air traffic control service	496
GM1 to AMC15 ATS.TR.210(a)(3) Operation of air traffic control service.....	496
AMC16 ATS.TR.210(a)(3) Operation of air traffic control service	496
GM1 to AMC16 ATS.TR.210(a)(3) Operation of air traffic control service.....	497
GM2 to AMC16 ATS.TR.210(a)(3) Operation of air traffic control service.....	497
AMC17 ATS.TR.210(a)(3) Operation of air traffic control service.....	497
GM1 to AMC17 ATS.TR.210(a)(3) Operation of air traffic control service.....	498
AMC18 ATS.TR.210(a)(3) Operation of air traffic control service	498
AMC19 ATS.TR.210(a)(3) Operation of air traffic control service	498
GM1 to AMC19 ATS.TR.210(a)(3) Operation of air traffic control service.....	499
AMC20 ATS.TR.210(a)(3) Operation of air traffic control service	499
GM1 to AMC20 ATS.TR.210(a)(3) Operation of air traffic control service.....	500
GM2 to AMC20 ATS.TR.210(a)(3) Operation of air traffic control service.....	500
AMC21 ATS.TR.210(a)(3) Operation of air traffic control service	500
GM1 ATS.TR.210(a)(3) Operation of air traffic control service	500
GM2 ATS.TR.210(a)(3) Operation of air traffic control service	501
GM3 ATS.TR.210(a)(3) Operation of air traffic control service	501
GM4 ATS.TR.210(a)(3) Operation of air traffic control service	501
GM5 ATS.TR.210(a)(3) Operation of air traffic control service	501
GM6 ATS.TR.210(a)(3) Operation of air traffic control service	502
GM7 ATS.TR.210(a)(3) Operation of air traffic control service	503
GM1 ATS.TR.210(b) Operation of air traffic control service	503
GM2 ATS.TR.210(b) Operation of air traffic control service	503
AMC1 ATS.TR.210(c) Operation of air traffic control service	504
GM1 to AMC1 ATS.TR.210(c) Operation of air traffic control service	504
GM2 ATS.TR.210(c) Operation of air traffic control service	504
AMC1 ATS.TR.210(c)(1) Operation of air traffic control.....	504
GM1 to AMC1 ATS.TR.210(c)(1) Operation of air traffic control service.....	505
GM1 ATS.TR.210(c)(1) Operation of air traffic control service.....	505
GM2 ATS.TR.210(c)(1) Operation of air traffic control service.....	505
GM3 ATS.TR.210(c)(1) Operation of air traffic control service.....	506
AMC1 ATS.TR.210(c)(2) Operation of air traffic control service.....	506
GM1 to AMC1 ATS.TR.210(c)(2) Operation of air traffic control service.....	507
AMC2 ATS.TR.210(c)(2) Operation of air traffic control service.....	507
AMC3 ATS.TR.210(c)(2) Operation of air traffic control service.....	508

GM1 ATS.TR.210(c)(2)(i) Operation of air traffic control service	509
AMC1 ATS.TR.210(c)(2)(i) Operation of air traffic control service	510
AMC2 ATS.TR.210(c)(2)(i) Operation of air traffic control service	513
AMC3 ATS.TR.210(c)(2)(i) Operation of air traffic control service	518
AMC4 ATS.TR.210(c)(2)(i) Operation of air traffic control service	521
GM1 to AMC3 ATS.TR.210(c)(2)(i) and AMC4 ATS.TR.210(c)(2)(i) Operation of air traffic control service.....	523
AMC5 ATS.TR.210(c)(2)(i) Operation of air traffic control service	523
AMC6 ATS.TR.210(c)(2)(i) Operation of air traffic control service	524
GM1 to AMC5 ATS.TR.210(c)(2)(i) and AMC6 ATS.TR.210(c)(2)(i) Operation of air traffic control service.....	525
GM1 to AMC6 ATS.TR.210(c)(2)(i) Operation of air traffic control service.....	526
AMC7 ATS.TR.210(c)(2)(i) Operation of air traffic control service	526
AMC8 ATS.TR.210(c)(2)(i) Operation of air traffic control service	527
AMC9 ATS.TR.210(c)(2)(i) Operation of air traffic control service	527
AMC10 ATS.TR.210(c)(2)(i) Operation of air traffic control service	529
AMC11 ATS.TR.210(c)(2)(i) Operation of air traffic control service	531
AMC1 ATS.TR.210(c)(2)(ii) Operation of air traffic control service	532
GM1 to AMC1 ATS.TR.210(c)(2)(ii) Operation of air traffic control service.....	535
GM1 ATS.TR.210(c)(2)(ii) Operation of air traffic control service	535
GM1 ATS.TR.210(d) Operation of air traffic control service	539
ATS.TR.215 Selection and notification of separation minima for the application of point ATS.TR.210(c)	539
ATS.TR.220 Application of wake turbulence separation.....	539
AMC1 ATS.TR.220 Application of wake turbulence separation	540
GM1 to AMC1 ATS.TR.220 Application of wake turbulence separation.....	540
AMC2 ATS.TR.220 Application of wake turbulence separation	540
AMC3 ATS.TR.220 Application of wake turbulence separation	540
AMC4 ATS.TR.220 Application of wake turbulence separation	542
AMC5 ATS.TR.220 Application of wake turbulence separation	543
AMC6 ATS.TR.220 Application of wake turbulence separation	544
GM1 to AMC6 ATS.TR.220 Application of wake turbulence separation.....	545
AMC7 ATS.TR.220 Application of wake turbulence separation	546
GM1 to AMC7 ATS.TR.220 Application of wake turbulence separation.....	548
GM1 ATS.TR.220 Application of wake turbulence separation	548
ATS.TR.225 Responsibility for control.....	548
ATS.TR.230 Transfer of responsibility for control	548
AMC1 ATS.TR.230 Transfer of responsibility for control.....	550
GM1 ATS.TR.230 Transfer of responsibility for control.....	551
GM2 ATS.TR.230 Transfer of responsibility for control.....	551
AMC1 ATS.TR.230(a) Transfer of responsibility for control	551
GM1 ATS.TR.230(a)(2) Transfer of responsibility for control	552
GM1 ATS.TR.230(a)(3) Transfer of responsibility for control	552
GM2 ATS.TR.230(a)(3) Transfer of responsibility for control	553
GM1 ATS.TR.230(a)(3)(i) Transfer of responsibility for control.....	553
GM1 ATS.TR.230(a)(3)(ii) Transfer of responsibility for control.....	553
AMC1 ATS.TR.230(a)(4) Transfer of responsibility for control	554
AMC1 ATS.TR.230(b)(2) Transfer of responsibility for control	554
AMC2 ATS.TR.230(b)(2) Transfer of responsibility for control	554
GM1 to AMC2 ATS.TR.230(b)(2) Transfer of responsibility for control	555
GM2 to AMC2 ATS.TR.230(b)(2) Transfer of responsibility for control	555
AMC3 ATS.TR.230(b)(2) Transfer of responsibility for control	556
GM1 to AMC3 ATS.TR.230(b)(2) Transfer of responsibility for control	556
GM2 to AMC3 ATS.TR.230(b)(2) Transfer of responsibility for control	556
GM1 ATS.TR.230(b)(2) Transfer of responsibility for control	557
GM2 ATS.TR.230(b)(2) Transfer of responsibility for control	557
GM3 ATS.TR.230(b)(2) Transfer of responsibility for control.....	558
AMC1 ATS.TR.230(b)(7) Transfer of responsibility for control.....	558
ATS.TR.235 ATC clearances	560
GM1 ATS.TR.235 ATC clearances	563
GM1 ATS.TR.235(a)(5) ATC clearances.....	563

AMC1 ATS.TR.235(b) ATC clearances	563
GM1 to AMC1 ATS.TR.235(b) ATC clearances	564
AMC2 ATS.TR.235(b) ATC clearances	564
GM1 to AMC2 ATS.TR.235(b) ATC clearances	564
AMC3 ATS.TR.235(b) ATC clearances	564
AMC4 ATS.TR.235(b) ATC clearances	565
AMC1 ATS.TR.235(b)(2) ATC clearances	565
GM1 to AMC1 ATS.TR.235(b)(2) ATC clearances	565
GM1 ATS.TR.235(b)(3)(i) ATC clearances	566
AMC1 ATS.TR.235(b)(4) ATC clearances	566
GM1 ATS.TR.235(b)(4) ATC clearances	566
GM1 ATS.TR.235(b)(5) ATC clearances	566
GM1 ATS.TR.235(c) ATC clearances	567
AMC1 ATS.TR.235(d) ATC clearances	567
GM1 ATS.TR.235(e) ATC clearances	567
GM2 ATS.TR.235(e) ATC clearances	567
GM1 ATS.TR.235(g)(2) ATC clearances	567
GM1 ATS.TR.235(h)(1) ATC clearances	567
GM1 ATS.TR.235(h)(3)(i) ATC clearances	568
ATS.TR.237 Dynamic reconfiguration of the U-space airspace	568
AMC1 ATS.TR.237(a) Dynamic reconfiguration of the U-space airspace	568
AMC2 ATS.TR.237(a) Dynamic reconfiguration of the U-space airspace	568
GM1 ATS.TR.237(a) Dynamic reconfiguration of the U-space airspace	569
GM2 ATS.TR.237(a) Dynamic reconfiguration of the U-space airspace	569
AMC1 ATS.TR.237(b) Dynamic reconfiguration of the U-space airspace	570
GM1 ATS.TR.237(b) Dynamic reconfiguration of the U-space airspace	570
ATS.TR.240 Control of persons and vehicles at controlled aerodromes	570
AMC1 ATS.TR.240(a) Control of persons and vehicles at controlled aerodromes	571
AMC2 ATS.TR.240(a) Control of persons and vehicles at controlled aerodromes	572
GM1 ATS.TR.240(b)(2) Control of persons and vehicles at controlled aerodromes	572
GM1 ATS.TR.240(c) Control of persons and vehicles at controlled aerodromes	572
ATS.TR.245 Use of surface movement surveillance equipment at aerodromes	572
GM1 ATS.TR.245 Use of surface movement surveillance equipment at aerodromes	573
GM2 ATS.TR.245 Use of surface movement surveillance equipment at aerodromes	573
ATS.TR.250 Essential traffic and essential local traffic information	574
AMC1 ATS.TR.250(a) Essential traffic and essential local traffic information	574
GM1 ATS.TR.250(a) Essential traffic and essential local traffic information	574
AMC1 ATS.TR.250(b) Essential traffic and essential local traffic information	574
ATS.TR.255 Operations on parallel or near-parallel runways	575
AMC1 ATS.TR.255 Operations on parallel or near-parallel runways	575
AMC2 ATS.TR.255 Operations on parallel or near-parallel runways	576
GM1 to AMC2 ATS.TR.255 Operations on parallel or near-parallel runways	579
GM2 to AMC2 ATS.TR.255 Operations on parallel or near-parallel runways	580
GM3 to AMC2 ATS.TR.255 Operations on parallel or near-parallel runways	580
GM4 to AMC2 ATS.TR.255 Operations on parallel or near-parallel runways	580
GM5 to AMC2 ATS.TR.255 Operations on parallel or near-parallel runways	581
GM6 to AMC2 ATS.TR.255 Operations on parallel or near-parallel runways	581
GM7 to AMC2 ATS.TR.255 Operations on parallel or near-parallel runways	584
AMC3 ATS.TR.255 Operations on parallel or near-parallel runways	584
GM1 to AMC3 ATS.TR.255 Operations on parallel or near-parallel runways	587
GM2 to AMC3 ATS.TR.255 Operations on parallel or near-parallel runways	587
AMC4 ATS.TR.255 Operations on parallel or near-parallel runways	587
GM1 to AMC2 ATS.TR.255; AMC3 ATS.TR.255 and AMC4 ATS.TR.255 Operations on parallel or near-parallel runways	588
GM1 ATS.TR.255 Operations on parallel or near-parallel runways	590
ATS.TR.260 Selection of the runway-in-use	590
AMC1 ATS.TR.260(g) Selection of the runway-in-use	590
GM1 ATS.TR.260 Selection of the runway-in-use	591
GM1 ATS.TR.260(e) Selection of the runway-in-use	591
ATS.TR.265 Control of aerodrome surface traffic in low-visibility conditions	591
GM1 ATS.TR.265(a)(1) Control of aerodrome surface traffic in low-visibility conditions	592

AMC1 ATS.TR.265(b) Control of aerodrome surface traffic in low-visibility conditions.....	592
ATS.TR.270 Authorisation of special VFR	593
GM1 ATS.TR.270 Authorisation of special VFR	593
GM1 ATS.TR.270(a)(3) Authorisation of special VFR	593
SECTION 3 - FLIGHT INFORMATION SERVICE	595
ATS.TR.300 Application	595
GM1 ATS.TR.300(a)(2) Application.....	595
GM1 ATS.TR.300(b) Application.....	595
AMC1 ATS.TR.300(c)(1) Application.....	595
GM1 to AMC1 ATS.TR.300(c)(1) Application	596
GM1 ATS.TR.300(c)(2) Application	596
GM2 ATS.TR.300(c)(2) Application.....	596
ATS.TR.305 Scope of flight information service	597
AMC1 ATS.TR.305 Scope of flight information service.....	598
GM1 ATS.TR.305 Scope of flight information service	600
AMC1 ATS.TR.305(a);(b) Scope of flight information service	600
GM1 to AMC1 ATS.TR.305(a);(b) Scope of flight information service	600
GM1 ATS.TR.305(a);(b);(c) Scope of flight information service.....	601
GM2 ATS.TR.305(a);(b);(c) Scope of flight information service.....	601
GM3 ATS.TR.305(a);(b);(c) Scope of flight information service.....	603
GM4 ATS.TR.305(a);(b);(c) Scope of flight information service.....	603
GM5 ATS.TR.305(a);(b);(c) Scope of flight information service.....	603
AMC1 ATS.TR.305(a)(5) Scope of flight information service	603
GM1 to AMC1 ATS.TR.305(a)(5) Scope of flight information service	604
AMC2 ATS.TR.305(a)(5) Scope of flight information service	604
GM1 ATS.TR.305(a)(6) Scope of flight information service	605
AMC1 ATS.TR.305(a)(7) Scope of flight information service	606
GM1 ATS.TR.305(a)(8) Scope of flight information service	606
GM2 ATS.TR.305(a)(8) Scope of flight information service	606
GM1 ATS.TR.305(b)(1) Scope of flight information service.....	606
GM1 ATS.TR.305(b)(2) and (c)(1) Scope of flight information service	606
GM2 ATS.TR.305(b)(2) Scope of flight information service.....	607
GM1 ATS.TR.305(b)(4) Scope of flight information service.....	607
GM1 ATS.TR.305(c)(1) Scope of flight information service	607
GM2 ATS.TR.305(c)(1) Scope of flight information service	607
GM1 ATS.TR.305(c)(2) Scope of flight information service	607
GM1 ATS.TR.305(d)(3) Scope of flight information service.....	608
ATS.TR.310 Voice-automatic terminal information service (Voice-ATIS) broadcasts	608
GM1 ATS.TR.310 Voice-automatic terminal information service (Voice-ATIS) broadcasts ..	609
GM1 ATS.TR.310(f) Voice-automatic terminal information service (Voice-ATIS) broadcasts ..	609
ATS.TR.315 Data link-automatic terminal information service (D-ATIS)	609
GM1 ATS.TR.315 Data link-automatic terminal information service (D-ATIS)	610
ATS.TR.320 Automatic terminal information service (voice and/or data link)	610
GM1 ATS.TR.320 Automatic terminal information service (voice and/or data link)	611
ATS.TR.325 VOLMET broadcasts and D-VOLMET broadcasts	611
GM1 ATS.TR.325 VOLMET broadcasts and D-VOLMET broadcasts.....	611
SECTION 4 - ALERTING SERVICE.....	612
ATS.TR.400 Application	612
GM1 ATS.TR.400(a)(2) Application.....	612
GM1 ATS.TR.400(b) Application.....	613
AMC1 ATS.TR.400(d) Application	613
ATS.TR.405 Notification to rescue coordination centres	614
GM1 ATS.TR.405(a)(1) Notification to rescue coordination centres	615
GM1 ATS.TR.405(a)(2)(ii) Notification to rescue coordination centres.....	615
GM1 ATS.TR.405(a)(2)(iii) Notification to rescue coordination centres.....	616
GM1 ATS.TR.405(c) Notification to rescue coordination centres	616

GM1 ATS.TR.405(d) Notification to rescue coordination centres	616
ATS.TR.410 Use of communication facilities	616
ATS.TR.415 Plotting aircraft in a state of emergency	616
AMC1 ATS.TR.415 Plotting aircraft in a state of emergency	617
ATS.TR.420 Information to the operator	617
ATS.TR.425 Information to aircraft operating in the vicinity of an aircraft in a state of emergency	617

ANNEX V — Part-MET 618

SUBPART A — ADDITIONAL ORGANISATION REQUIREMENTS FOR PROVIDERS OF METEOROLOGICAL SERVICES (MET.OR) 618

SECTION 1 — GENERAL REQUIREMENTS	618
MET.OR.100 Meteorological data and information.....	618
GM1 MET.OR.100 Meteorological data and information	618
GM2 MET.OR.100 Meteorological data and information	618
AMC1 MET.OR.100(a) Meteorological data and information	619
GM1 MET.OR.100(a) Meteorological data and information	619
MET.OR.105 Retention of meteorological information.....	619
GM1 MET.OR.105(b) Retention of meteorological information	619
MET.OR.110 Meteorological information exchange requirements.....	620
GM1 MET.OR.110 Meteorological information exchange requirements	620
GM2 MET.OR.110 Meteorological information exchange requirements	620
GM1 MET.OR.110(a) Meteorological information exchange requirements	620
MET.OR.115 Meteorological bulletins	620
MET.OR.120 Notification of discrepancies to the world area forecast centres (WAFCs).....	621
GM1 MET.OR.120 Notification of discrepancies to the world area forecast centres (WAFCs)	621
SECTION 2 — SPECIFIC REQUIREMENTS.....	622
Chapter 1 — Requirements for aeronautical meteorological stations.....	622
MET.OR.200 Meteorological reports and other information.....	622
GM1 MET.OR.200(a) Meteorological reports and other information	622
AMC1 MET.OR.200(a) Meteorological reports and other information	622
GM1 MET.OR.200(a)(2) Meteorological reports and other information.....	623
AMC1 MET.OR.200(a)(3) Meteorological reports and other information.....	623
AMC2 MET.OR.200(a)(3) Meteorological reports and other information.....	623
GM1 MET.OR.200(a)(3) Meteorological reports and other information.....	623
AMC1 MET.OR.200(b) Meteorological reports and other information	624
AMC2 MET.OR.200(b) Meteorological reports and other information	624
GM1 MET.OR.200(b) Meteorological reports and other information.....	625
GM2 MET.OR.200(b) Meteorological reports and other information.....	625
GM3 MET.OR.200(b) Meteorological reports and other information.....	625
AMC1 MET.OR.200(d) Meteorological reports and other information	625
MET.OR.205 Reporting of meteorological elements	626
MET.OR.210 Observing meteorological elements	626
AMC1 MET.OR.210 Observing meteorological elements	626
AMC2 MET.OR.210 Observing meteorological elements	627
Chapter 2 — Requirements for aerodrome meteorological offices	628
MET.OR.215 Forecasts and other information.....	628
AMC1 MET.OR.215(a) Forecasts and other information.....	628
GM1 MET.OR.215(a) Forecasts and other information.....	629
GM2 MET.OR.215(a) Forecasts and other information.....	629
AMC1 MET.OR.215(c) Forecasts and other information.....	629
GM1 MET.OR.215(c) Forecasts and other information.....	629
GM2 MET.OR.215(c) Forecasts and other information.....	629
GM3 MET.OR.215(c) Forecasts and other information.....	629
GM1 MET.OR.215(d) Forecasts and other information	630
GM2 MET.OR.215(d) Forecasts and other information	630

GM3 MET.OR.215(d) Forecasts and other information	630
AMC1 MET.OR.215(e) Forecasts and other information.....	630
AMC1 MET.OR.215(f) Forecasts and other information	630
AMC1 MET.OR.215(g) Forecasts and other information.....	631
MET.OR.220 Aerodrome forecasts.....	631
AMC1 MET.OR.220(a) Aerodrome forecasts.....	631
GM1 MET.OR.220(a) Aerodrome forecasts	631
MET.OR.225 Forecasts for landing	632
GM1 MET.OR.225 Forecasts for landing	632
GM1 MET.OR.225(a) Forecasts for landing.....	632
GM1 MET.OR.225(b) Forecasts for landing.....	632
MET.OR.230 Forecasts for take-off	632
MET.OR.235 Aerodrome warnings and wind shear warnings and alerts	633
GM1 MET.OR.235 Aerodrome warnings and wind shear warnings and alerts	633
AMC1 MET.OR.235(c) Aerodrome warnings and wind shear warnings and alerts	633
GM1 MET.OR.235(c) Aerodrome warnings and wind shear warnings and alerts	633
GM1 MET.OR.235(d) Aerodrome warnings and wind shear warnings and alerts	634
MET.OR.240 Information for use by operator or flight crew	634
GM1 MET.OR.240(a) Information for use by operator or flight crew	634
GM1 MET.OR.240(b) Information for use by operator or flight crew	634
GM1 MET.OR.240(d) Information for use by operator or flight crew	635
GM1 MET.OR.240(e) Information for use by operator or flight crew	635
MET.OR.242 Information to be provided to air traffic services units	635
Chapter 3 — Requirements for meteorological watch offices	637
MET.OR.245 Meteorological watch and other information.....	637
AMC1 MET.OR.245(a) Meteorological watch and other information	638
AMC1 MET.OR.245(f)(3) Meteorological watch and other information	638
MET.OR.250 SIGMET	638
AMC1 MET.OR.250(a) SIGMET.....	638
AMC2 MET.OR.250(a) SIGMET	638
GM1 MET.OR.250(a) SIGMET.....	639
AMC1 MET.OR.250(c) SIGMET	639
MET.OR.255 AIRMET	639
AMC1 MET.OR.255(a) AIRMET.....	639
GM1 MET.OR.255(a) AIRMET.....	639
MET.OR.260 Area forecasts for low-level flights.....	639
Chapter 4 — Requirements for volcanic ash advisory centres (VAACs)	641
MET.OR.265 Volcanic ash advisory centre responsibilities	641
AMC1 MET.OR.265(a) Volcanic ash advisory centre responsibilities	641
GM1 MET.OR.265(a) Volcanic ash advisory centres (VAACs) responsibilities	641
GM2 MET.OR.265(a) Volcanic ash advisory centre responsibilities	641
Chapter 5 — Requirements for tropical cyclone advisory centres (TCACs).....	642
MET.OR.270 Tropical cyclone advisory centre responsibilities	642
AMC1 MET.OR.270(a) Tropical cyclone advisory centre responsibilities	642
GM1 MET.OR.270(a) Tropical cyclone advisory centre responsibilities	642
Chapter 6 — Requirements for world area forecast centres (WAFCs)	643
MET.OR.275 World area forecast centre responsibilities	643
AMC1 MET.OR.275(a) World area forecast centre responsibilities	643

**SUBPART B — TECHNICAL REQUIREMENTS FOR PROVIDERS OF METEOROLOGICAL SERVICES
(MET.TR)** **644**

SECTION 1 — GENERAL REQUIREMENTS **644**

MET.TR.115 Meteorological bulletins.....	644
AMC1 MET.TR.115(a) Meteorological bulletins	644
GM1 MET.TR.115(a) Meteorological bulletins	644
GM2 MET.TR.115(a) Meteorological bulletins	645
GM3 MET.TR.115(a) Meteorological bulletins	645

SECTION 2 — SPECIFIC REQUIREMENTS..... **646**

Chapter 1 — Technical requirements for aeronautical meteorological stations **646**

MET.TR.200 Meteorological reports and other information	646
AMC1 MET.TR.200(a) Meteorological reports and other information.....	649
GM1 MET.TR.200(a) Meteorological reports and other information.....	653

GM2 MET.TR.200(a) Meteorological reports and other information	654
GM1 MET.TR.200(a)(2) Meteorological reports and other information	656
AMC1 MET.TR.200(a)(4) Meteorological reports and other information	656
GM1 MET.TR.200(a)(4) Meteorological reports and other information	656
AMC1 MET.TR.200(a)(12) Meteorological reports and other information	657
AMC2 MET.TR.200(a)(12) Meteorological reports and other information	658
AMC3 MET.TR.200(a)(12) Meteorological reports and other information	658
AMC4 MET.TR.200(a)(12) Meteorological reports and other information	658
AMC5 MET.TR.200(a)(12) Meteorological reports and other information	658
GM1 MET.TR.200(a)(12) Meteorological reports and other information	659
GM2 MET.TR.200(a)(12) Meteorological reports and other information	659
GM3 MET.TR.200(a)(12) Meteorological reports and other information	659
GM1 MET.TR.200(b) & (c) Meteorological reports and other information	659
GM1 MET.TR.200(b) Meteorological reports and other information	660
AMC1 MET.TR.200(c) Meteorological reports and other information	660
GM1 MET.TR.200(e)(5) Meteorological reports and other information	661
GM1 MET.TR.200(f) Meteorological reports and other information	661
AMC1 MET.TR.200(f)(8) Meteorological reports and other information	661
MET.TR.205 Reporting of meteorological elements	661
GM1 MET.TR.205(a)(3)(iii)(A) Reporting of meteorological elements	665
AMC1 MET.TR.205(b)(1) Reporting of meteorological elements	665
AMC1 MET.TR.205(b)(3) Reporting of meteorological elements	665
AMC1 MET.TR.205(c) Reporting of meteorological elements	665
AMC1 MET.TR.205(c)(1) Reporting of meteorological elements	666
AMC1 MET.TR.205(c)(3) Reporting of meteorological elements	666
AMC1 MET.TR.205(c)(4)(iii) Reporting of meteorological elements	666
AMC1 MET.TR.205(d) Reporting of meteorological elements	667
AMC2 MET.TR.205(d) Reporting of meteorological elements	667
AMC3 MET.TR.205(d) Reporting of meteorological elements	668
AMC1 MET.TR.205(d)(3) Reporting of meteorological elements	668
AMC2 MET.TR.205(d)(3) Reporting of meteorological elements	669
GM1 MET.TR.205(d)(3)(i) Reporting of meteorological elements	669
AMC1 MET.TR.205(e)(1) Reporting of meteorological elements	669
AMC2 MET.TR.205(e)(1) Reporting of meteorological elements	670
AMC1 MET.TR.205(e)(3) Reporting of meteorological elements	670
MET.TR.210 Observing meteorological elements	671
AMC1 MET.TR.210 Observing meteorological elements	674
GM1 MET.TR.210 Observing meteorological elements	674
GM2 MET.TR.210 Observing meteorological elements	674
AMC1 MET.TR.210(a) Observing meteorological elements	674
GM1 MET.TR.210(a) Observing meteorological elements	675
AMC1 MET.TR.210(a)(1) Observing meteorological elements	675
GM1 MET.TR.210(a)(1) Observing meteorological elements	675
AMC1 MET.TR.210(a)(2) Observing meteorological elements	675
AMC1 MET.TR.210(a)(3) Observing meteorological elements	675
GM1 MET.TR.210(a)(3)(ii) Observing meteorological elements	676
AMC1 MET.TR.210(b)(1) Observing meteorological elements	676
AMC1 MET.TR.210(b)(2) Observing meteorological elements	676
AMC1 MET.TR.210(b)(4) Observing meteorological elements	676
GM1 MET.TR.210(b)(4) Observing meteorological elements	677
AMC1 MET.TR.210(c) Observing meteorological elements	677
GM1 MET.TR.210(c) Observing meteorological elements	677
AMC1 MET.TR.210(c)(2) Observing meteorological elements	677
AMC1 MET.TR.210(c)(3) Observing meteorological elements	677
GM1 MET.TR.210(c)(3) Observing meteorological elements	678
GM2 MET.TR.210(c)(3) Observing meteorological elements	678
GM1 MET.TR.210(c)(5)(ii)(B) Observing meteorological elements	678
AMC1 MET.TR.210(d)(1) Observing meteorological elements	679
AMC1 MET.TR.210(d)(2) Observing meteorological elements	679
AMC1 MET.TR.210(e) Observing meteorological elements	679
AMC1 MET.TR.210(e)(2) Observing meteorological elements	679
AMC1 MET.TR.210(f) Observing meteorological elements	679
AMC1 MET.TR.210(g)(3) Observing meteorological elements	680
Chapter 2 — Technical requirements for aerodrome meteorological offices.....	681
MET.TR.215 Forecasts and other information	681
AMC1 MET.TR.215(a) Forecasts and other information	682
AMC2 MET.TR.215(a) Forecasts and other information	683
AMC3 MET.TR.215(a) Forecasts and other information	683

GM1 MET.TR.215(a) Forecasts and other information	683
GM1 MET.TR.215(b) Forecasts and other information	683
GM2 MET.TR.215(b) Forecasts and other information	684
AMC1 MET.TR.215(d)(5) Forecasts and other information	684
AMC1 MET.TR.215(e) Forecasts and other information	684
AMC1 MET.TR.215(e)(1) & (2) Forecasts and other information	685
GM1 MET.TR.215(e)(1) & (2) Forecasts and other information	686
AMC2 MET.TR.215(e)(1) & (2) Forecasts and other information	693
AMC1 MET.TR.215(f) Forecasts and other information	693
AMC2 MET.TR.215(f) Forecasts and other information	693
GM1 MET.TR.215(f) Forecasts and other information	694
GM2 MET.TR.215(f) Forecasts and other information	694
GM1 MET.TR.215(g) Forecasts and other information	694
AMC1 MET.TR.215(i) Forecasts and other information	694
AMC2 MET.TR.215(i) Forecasts and other information	694
AMC3 MET.TR.215(i) Forecasts and other information	694
AMC4 MET.TR.215(i) Forecasts and other information	695
AMC5 MET.TR.215(i) Forecasts and other information	695
AMC6 MET.TR.215(i) Forecasts and other information	695
GM1 MET.TR.215(i) Forecasts and other information	695
GM2 MET.TR.215(i) Forecasts and other information	696
GM3 MET.TR.215(i) Forecasts and other information	696
MET.TR.220 Aerodrome forecasts	696
GM1 MET.TR.220 Aerodrome forecasts	699
GM2 MET.TR.220 Aerodrome forecasts	700
GM3 MET.TR.220 Aerodrome forecasts	700
GM1 MET.TR.220(a)(8) Aerodrome forecasts	700
AMC1 MET.TR.220(b) Aerodrome forecasts	700
AMC1 MET.TR.220(c) Aerodrome forecasts	700
GM1 MET.TR.220(e)(2)(i) Aerodrome forecasts	701
AMC1 MET.TR.220(f) Aerodrome forecasts	701
GM1 MET.TR.220(f)(1) Aerodrome forecasts	702
AMC1 MET.TR.220(g) Aerodrome forecasts	703
GM1 MET.TR.220(g) Aerodrome forecasts	703
MET.TR.225 Forecasts for landing.....	703
AMC1 MET.TR.225(c)(1)(iii) Forecasts for landing	706
GM1 MET.TR.225(c)(2)(iii) Forecasts for landing	706
AMC1 MET.TR.225(c)(7)(ii) Forecasts for landing	706
GM1 MET.TR.225(c)(7)(ii) Forecasts for landing	707
AMC1 MET.TR.225(c)(7)(iii) Forecasts for landing	707
MET.TR.230 Forecasts for take-off.....	708
AMC1 MET.TR.230(a) Forecasts for take-off.....	708
MET.TR.235 Aerodrome warnings and wind shear warnings and alerts.....	708
AMC1 MET.TR.235 Aerodrome warnings and wind shear warnings and alerts	709
GM1 MET.TR.235 Aerodrome warnings and wind shear warnings and alerts	710
GM2 MET.TR.235 Aerodrome warnings and wind shear warnings and alerts	711
GM3 MET.TR.235 Aerodrome warnings and wind shear warnings and alerts	711
AMC1 MET.TR.235(a) Aerodrome warnings and wind shear warnings and alerts	712
AMC1 MET.TR.235(c) Aerodrome warnings and wind shear warnings and alerts	712
GM1 MET.TR.235(a) Aerodrome warnings and wind shear warnings and alerts	712
GM2 MET.TR.235(a) Aerodrome warnings and wind shear warnings and alerts	712
GM1 MET.TR.235(c) Aerodrome warnings and wind shear warnings and alerts	713
GM1 MET.TR.235(d) Aerodrome warnings and wind shear warnings and alerts	713
Chapter 3 — Technical requirements for meteorological watch offices	714
MET.TR.250 SIGMET.....	714
AMC1 MET.TR.250(a) SIGMET	714
AMC2 MET.TR.250(a) SIGMET	714
AMC3 MET.TR.250(a) SIGMET	715
AMC4 MET.TR.250(a) SIGMET	718
GM1 MET.TR.250(a) SIGMET	719
GM2 MET.TR.250(a) SIGMET	719
GM3 MET.TR.250(a) SIGMET	719
GM4 MET.TR.250(a) SIGMET	720
GM5 MET.TR.250(a) SIGMET	720
GM6 MET.TR.250(a) SIGMET	720
GM7 MET.TR.250(a) SIGMET	721
AMC1 MET.TR.250(c) SIGMET	721
AMC1 MET.TR.250(d) SIGMET	722

GM1 MET.TR.250(d) SIGMET	722
MET.TR.255 AIRMET	723
AMC1 MET.TR.255(a) AIRMET	723
GM1 MET.TR.255(a) AIRMET	723
GM2 MET.TR.255(a) AIRMET	724
GM1 MET.TR.255(b) AIRMET	724
GM1 MET.TR.255(c) AIRMET	724
AMC1 MET.TR.255(d) AIRMET	724
MET.TR.260 Area forecasts for low-level flights	724
AMC1 MET.TR.260 Area forecasts for low-level flights.....	725
Chapter 4 — Technical requirements for volcanic ash advisory centres (VAACs)	726
MET.TR.265 Volcanic ash advisory centre responsibilities.....	726
AMC1 MET.TR.265 Volcanic ash advisory centre responsibilities	726
AMC2 MET.TR.265 Volcanic ash advisory centre responsibilities	726
GM1 MET.TR.265 Volcanic ash advisory centre responsibilities	729
Chapter 5 — Technical requirements for tropical cyclone advisory centres (TCACs)	732
MET.TR.270 Tropical cyclone advisory centre responsibilities.....	732
AMC1 MET.TR.270 Tropical cyclone advisory centre responsibilities	732
AMC2 MET.TR.270 Tropical cyclone advisory centre responsibilities	732
GM1 MET.TR.270 Tropical cyclone advisory centre responsibilities	733
Chapter 6 — Technical requirements for world area forecast centres (WAFcS)	735
MET.TR.275 World area forecast centre responsibilities	735
AMC1 MET.TR.275(a) World area forecast centres (WAFcS) responsibilities	738
AMC2 MET.TR.275(a) World area forecast centre responsibilities	738
GM1 MET.TR.275(b)(3) World area forecast centre responsibilities.....	738
GM2 MET.TR.275(b)(3) World area forecast centre responsibilities.....	738
GM3 MET.TR.275(b)(3) World area forecast centre responsibilities.....	738
AMC1 MET.TR.275(c) World area forecast centre responsibilities	739
AMC1 MET.TR.275(d) World area forecast centre responsibilities	739
APPENDICES TO ANNEX V	740
Appendix 1.....	740
GM1 to Appendix 1 ‘Template for METAR and SPECI’	745
Appendix 2.....	748
Appendix 3.....	751
GM1 to Appendix 3 ‘Template for TAF’	754
Appendix 4.....	756
GM1 to Appendix 4 ‘Template for wind shear warnings’	757
Appendix 5.....	758
GM1 to Appendix 5 ‘Template for SIGMET and AIRMET’	763
Appendix 6.....	767
GM1 to Appendix 6 ‘Template for advisory for volcanic ash’	770
Appendix 7.....	774
GM1 to Appendix 7 ‘Template for advisory for tropical cyclones’	777
Appendix 8.....	779
ANNEX VI — Part-AIS	780
SUBPART A – ADDITIONAL ORGANISATION REQUIREMENTS FOR PROVIDERS OF AERONAUTICAL INFORMATION SERVICES (AIS.OR).....	780
SECTION 1 — GENERAL REQUIREMENTS	780

AIS.OR.100 Aeronautical information management	780
GM1 AIS.OR.100 Aeronautical information management	780
AIS.OR.105 Responsibilities of aeronautical information services (AIS) providers	781
GM1 AIS.OR.105 Responsibilities of aeronautical information services providers	781
GM1 AIS.OR.105(1) Responsibilities of aeronautical information services (AIS) providers ..	782
GM1 AIS.OR.105(3) Responsibilities of aeronautical information services providers.....	782
SECTION 2 — DATA QUALITY MANAGEMENT.....	783
AIS.OR.200 General	783
GM1 AIS.OR.200(a) General.....	783
GM1 AIS.OR.200(b) General.....	783
AMC1 AIS.OR.200(c) General	783
AIS.OR.205 Formal arrangements.....	784
AMC1 AIS.OR.205 Formal arrangements	784
AIS.OR.210 Exchange of aeronautical data and aeronautical information.....	784
AMC1 AIS.OR.210(a) Exchange of aeronautical data and aeronautical information	785
GM1 AIS.OR.210(a) Exchange of aeronautical data and aeronautical information	785
GM2 AIS.OR.210(a) Exchange of aeronautical data and aeronautical information	785
GM1 AIS.OR.210(b) Exchange of aeronautical data and information	785
AIS.OR.215 Tools and software.....	785
GM1 AIS.OR.215 Tools and software	786
GM2 AIS.OR.215 Tools and software	786
AIS.OR.220 Validation and verification	786
GM1 AIS.OR.220 Validation and verification	786
AMC1 AIS.OR.220 Validation and verification.....	787
AIS.OR.225 Metadata	787
GM1 AIS.OR.225 Metadata	788
AIS.OR.230 Data error detection and authentication.....	788
GM1 AIS.OR.230 Data error detection and authentication	788
GM1 AIS.OR.230(a) Data error detection and authentication	788
AIS.OR.235 Error reporting, error measurement, and corrective actions	788
GM1 AIS.OR.235 Error reporting, error measurement and corrective actions	789
AIS.OR.240 Data limitations	789
AIS.OR.250 Consistency requirement	789
AMC1 AIS.OR.250 Consistency requirement.....	789
GM1 AIS.OR.250 Consistency requirement	790
SECTION 3 - AERONAUTICAL INFORMATION PRODUCTS.....	791
AIS.OR.300 General – Aeronautical information products	791
GM1 AIS.OR.300 Aeronautical information products	791
Chapter 1 — Aeronautical information in a standardised presentation	791
AIS.OR.305 Aeronautical information publication (AIP).....	791
AIS.OR.310 AIP amendments	791
AIS.OR.315 AIP supplements.....	791
AIS.OR.320 Aeronautical information circular (AIC).....	792
AIS.OR.325 Aeronautical charts	792
AMC1 AIS.OR.325 Aeronautical charts.....	793
AIS.OR.330 NOTAM.....	793
GM1 AIS.OR.330(a) NOTAM.....	793
GM1 AIS.OR.330(b) NOTAM	793
GM2 AIS.OR.330(b) NOTAM	793
Chapter 2 — Digital data sets.....	795
AIS.OR.335 General – Digital data sets.....	795
GM1 AIS.OR.335(a) General — Digital data sets.....	795
AIS.OR.340 Metadata requirements	795
AIS.OR.345 AIP data set	795
GM1 AIS.OR.345 AIP data set	795
AIS.OR.350 Terrain and obstacle data – General requirements.....	796

GM1 AIS.OR.350 Terrain and obstacle data – General requirements	796
GM2 AIS.OR.350 Terrain and obstacle data – General requirements	796
AIS.OR.355 Terrain data sets.....	797
GM1 AIS.OR.355 Terrain data sets.....	797
GM1 AIS.OR.355(b)(3) Terrain data sets.....	797
GM1 AIS.OR.355(b)(4) Terrain data sets.....	797
AIS.OR.360 Obstacle data sets	798
GM1 AIS.OR.360 Obstacle data sets	798
AIS.OR.365 Aerodrome mapping data sets	798
AIS.OR.370 Instrument flight procedure data sets.....	798
SECTION 4 — DISTRIBUTION AND PRE-FLIGHT INFORMATION SERVICES	799
AIS.OR.400 Distribution services.....	799
GM1 AIS.OR.400(a) Distribution services.....	799
AIS.OR.405 Pre-flight information services.....	800
GM1 AIS.OR.405(a) Pre-flight information services.....	800
GM1 AIS.OR.405(b) Pre-flight information services.....	800
SECTION 5 — AERONAUTICAL INFORMATION PRODUCTS UPDATES	801
AIS.OR.500 General – Aeronautical information products updates	801
AIS.OR.505 Aeronautical information regulation and control (AIRAC).....	801
GM1 AIS.OR.505 Aeronautical information regulation and control (AIRAC).....	801
AMC1 AIS.OR.505(2) Aeronautical information regulation and control (AIRAC)	801
AIS.OR.510 NOTAM	802
AIS.OR.515 Data set updates	802
AMC1 AIS.OR.515 Data set updates.....	802
SECTION 6 — PERSONNEL REQUIREMENTS	803
AIS.OR.600 General requirements	803
GM1 AIS.OR.600(b) General requirements.....	803
SUBPART B — TECHNICAL REQUIREMENTS FOR PROVIDERS OF AERONAUTICAL INFORMATION SERVICES (AIS.TR)	804
SECTION 2 - DATA QUALITY MANAGEMENT	804
AIS.TR.200 General.....	804
GM1 AIS.TR.200(b) General	804
AMC1 AIS.TR.200(d) General	805
AIS.TR.210 Exchange of aeronautical data and aeronautical information	805
AMC1 AIS.TR.210 Exchange of aeronautical data and aeronautical information	805
GM1 to AMC1 AIS.TR.210 Exchange of aeronautical data and aeronautical information.....	806
AIS.TR.220 Verification.....	806
AIS.TR.225 Metadata.....	806
AMC1 AIS.TR.225(a) Metadata	806
AMC1 AIS.TR.225(b) Metadata	806
GM1 AIS.TR.225 Metadata.....	807
AIS.TR.235 Error reporting, error measurement and corrective actions.....	807
AIS.TR.240 Data limitations.....	807
GM1 AIS.TR.240 Data limitations	807
SECTION 3 - AERONAUTICAL INFORMATION PRODUCTS.....	809
AIS.TR.300 General – Aeronautical information products.....	809
GM1 AIS.TR.300(b) General — Aeronautical information products	809
Chapter 1 – Aeronautical information in a standardised presentation	809
AIS.TR.305 Aeronautical information publication (AIP)	809
AMC1 AIS.TR.305(a) Aeronautical information publication (AIP).....	810
AMC2 AIS.TR.305(a) Aeronautical information publication (AIP).....	810
GM1 AIS.TR.305(a) Aeronautical information publication (AIP)	810
AMC1 AIS.TR.305(c) Aeronautical information publication (AIP).....	811
AMC2 AIS.TR.305(c) Aeronautical information publication (AIP).....	812
AMC3 AIS.TR.305(c) Aeronautical information publication (AIP).....	813

AMC4 AIS.TR.305(c) Aeronautical information publication (AIP).....	813
GM1 AIS.TR.305(c) Aeronautical information publication (AIP).....	814
GM2 AIS.TR.305(c) Aeronautical information publication (AIP).....	814
GM3 AIS.TR.305(c) Aeronautical information publication (AIP).....	814
GM4 AIS.TR.305(c) Aeronautical information publication (AIP).....	815
GM5 AIS.TR.305(c) Aeronautical information publication (AIP).....	815
GM6 AIS.TR.305(c) Aeronautical information publication (AIP).....	815
GM7 AIS.TR.305(c) Aeronautical information publication (AIP).....	816
AIS.TR.310 AIP amendments.....	816
AMC1 AIS.TR.310(g) AIP amendments.....	816
GM1 AIS.TR.310(h) AIP amendments.....	816
AIS.TR.315 AIP supplements.....	817
GM1 AIS.TR.315 AIP supplements.....	817
AIS.TR.320 Aeronautical information circular (AIC).....	817
AMC1 AIS.TR.320(a) Aeronautical information circular (AIC).....	818
GM1 AIS.TR.320(a) Aeronautical information circular (AIC).....	818
GM1 AIS.TR.320(c) Aeronautical information circular (AIC).....	819
GM1 AIS.TR.320(d) Aeronautical information circular (AIC).....	819
AIS.TR.330 NOTAM.....	820
AMC1 AIS.TR.330 NOTAM.....	823
GM1 AIS.TR.330(d) NOTAM.....	823
GM1 AIS.TR.330(u) NOTAM.....	823
Chapter 2 — Digital data sets.....	824
AIS.TR.335 General— Digital data sets.....	824
GM1 AIS.TR.335(a) General — Digital data sets.....	824
GM1 AIS.TR.335(b) General — Digital data sets.....	824
AIS.TR.340 Metadata requirements.....	824
AIS.TR.345 AIP data set.....	825
GM1 AIS.TR.345(b) AIP data set.....	826
AIS.TR.350 Terrain and obstacle data – General requirements.....	826
GM1 AIS.TR.350(d) Terrain and obstacle data — General requirements.....	826
AIS.TR.355 Terrain data sets.....	827
GM1 AIS.TR.355(e) Terrain data sets.....	828
AIS.TR.360 Obstacle data sets.....	829
GM1 AIS.TR.360(b) Obstacle data sets.....	831
AIS.TR.365 Aerodrome mapping data sets.....	831
GM1 AIS.TR.365 Aerodrome mapping data sets.....	832
GM1 AIS.TR.365(a) Aerodrome mapping data sets.....	832
GM2 AIS.TR.365(a) Aerodrome mapping data sets.....	832
GM3 AIS.TR.365(a) Aerodrome mapping data sets.....	832
GM1 AIS.TR.365(b) Aerodrome mapping data sets.....	832
GM1 AIS.TR.365(c) Aerodrome mapping data sets.....	832
GM1 AIS.TR.365(d) Aerodrome mapping data sets.....	833
AIS.TR.370 Instrument flight procedure data sets.....	833
GM1 AIS.TR.370 Instrument flight procedure data sets.....	833
SECTION 4 - DISTRIBUTION SERVICES.....	834
AIS.TR.400 Distribution services.....	834
GM1 AIS.TR.400(a) Distribution services.....	834
AIS.TR.405 Pre-flight information services.....	835
GM1 AIS.TR.405(a) Pre-flight information services.....	835
GM1 AIS.TR.405(e) Pre-flight information services.....	836
SECTION 5 - AERONAUTICAL INFORMATION PRODUCTS UPDATES.....	837
AIS.TR.500 General – Aeronautical information products updates.....	837
AIS.TR.505 AIRAC.....	837
GM1 AIS.TR.505(a) AIRAC.....	838
AMC1 AIS.TR.505(b) AIRAC.....	838
AIS.TR.510 NOTAM.....	838
GM1 AIS.TR.510(a) NOTAM.....	839
AIS.TR.515 Data set updates.....	839
APPENDICES TO ANNEX VI.....	840

Appendix 1.....	840
PART 1 – GENERAL (GEN).....	840
PART 2 – EN-ROUTE (ENR).....	854
PART 3 – AERODROMES (AD).....	864
Appendix 2.....	882
Appendix 3.....	887
Appendix 4.....	893

ANNEX VII — Part-DAT 897

SUBPART A — ADDITIONAL ORGANISATION REQUIREMENTS FOR PROVIDERS OF DATA SERVICES (DAT.OR) 897

SECTION 1 — GENERAL REQUIREMENTS	897
DAT.OR.100 Aeronautical data and information	897
AMC1 DAT.OR.100 Aeronautical data and information.....	897
GM1 DAT.OR.100 Aeronautical data and information.....	898
AMC1 DAT.OR.100(a) Aeronautical data and information.....	898
GM1 to AMC1 DAT.OR.100(a) Aeronautical data and information.....	899
GM2 to AMC1 DAT.OR.100(a) Aeronautical data and information.....	899
GM3 to AMC1 DAT.OR.100(a) Aeronautical data and information.....	899
GM1 DAT.OR.100(a) Aeronautical data and information	899
GM1 DAT.OR.100(b) Aeronautical data and information	899
DAT.OR.105 Technical and operational competence and capability.....	900
GM1 DAT.OR.105(a)(1) Technical and operational competence and capability	900
GM2 DAT.OR.105(a)(1) Technical and operational competence and capability	901
AMC1 DAT.OR.105(a)(2) Technical and operational competence and capability	901
AMC2 DAT.OR.105(a)(2) Technical and operational competence and capability	902
GM1 DAT.OR.105(b) Technical and operational competence and capability	902
DAT.OR.110 Management system	902
AMC1 DAT.OR.110 Management system	903
AMC2 DAT.OR.110 Management system	903
AMC1 DAT.OR.110(h) Management system	903
DAT.OR.115 Record-keeping.....	903
SECTION 2 — SPECIFIC REQUIREMENTS.....	904
DAT.OR.200 Reporting requirements	904
GM1 DAT.OR.200 Reporting requirements.....	904
GM1 DAT.OR.200(b) Reporting requirements	905

SUBPART B — TECHNICAL REQUIREMENTS FOR PROVIDERS OF DATA SERVICES (DAT.TR) 906

SECTION 1 — GENERAL REQUIREMENTS	906
DAT.TR.100 Working methods and operating procedures	906
AMC1 DAT.TR.100(a)(1) Working methods and operating procedures	906
AMC1 DAT.TR.100(a)(2) Working methods and operating procedures	907
GM1 DAT.TR.100(a)(2) Working methods and operating procedures	907
AMC1 DAT.TR.100(a)(3) Working methods and operating procedures	907
GM1 DAT.TR.100(b) Working methods and operating procedures	907
AMC1 DAT.TR.100(b)(1) Working methods and operating procedures	907
AMC1 DAT.TR.100(b)(2) Working methods and operating procedures	908
GM1 DAT.TR.100(b)(2) Working methods and operating procedures.....	908
AMC1 DAT.TR.100(b)(3) Working methods and operating procedures.....	908
DAT.TR.105 Required interfaces	909
AMC1 DAT.TR.105(a) Required interfaces	909
AMC1 DAT.TR.105(b) Required interfaces	909
AMC1 DAT.TR.105(c) Required interfaces.....	909

ANNEX VIII — Part-CNS	910
SUBPART A — ADDITIONAL ORGANISATION REQUIREMENTS FOR PROVIDERS OF COMMUNICATION, NAVIGATION, OR SURVEILLANCE SERVICES (CNS.OR)	910
SECTION 1 — GENERAL REQUIREMENTS	910
CNS.OR.100 Technical and operational competence and capability	910
AMC1 CNS.OR.100 Technical and operational competence and capability	910
SUBPART B — TECHNICAL REQUIREMENTS FOR PROVIDERS OF COMMUNICATION, NAVIGATION OR SURVEILLANCE SERVICES (CNS.TR)	912
SECTION 1 — GENERAL REQUIREMENTS	912
CNS.TR.100 Working methods and operating procedures for providers of communication, navigation or surveillance services	912
Acceptable Means of Compliance (AMC) and Guidance Material (GM) to Part-CNS Specific requirements for providers of communication, navigation, or surveillance services	913
ANNEX IX — Part-ATFM	914
TECHNICAL REQUIREMENTS FOR PROVIDERS OF AIR TRAFFIC FLOW MANAGEMENT (ATFM.TR)	914
SECTION 1 — GENERAL REQUIREMENTS	914
ATFM.TR.100 Working methods and operating procedures for providers of air traffic flow management	914
Acceptable Means of Compliance (AMC) and Guidance Material (GM) to Part-ATFM	915
ANNEX X — Part-ASM	916
TECHNICAL REQUIREMENTS FOR PROVIDERS OF AIRSPACE MANAGEMENT (ASM.TR)	916
SECTION 1 — GENERAL REQUIREMENTS	916
ASM.TR.100 Working methods and operating procedures for providers of airspace management	916
GM1 to AMC1 ATS.TR.210(a)(3) Operation of air traffic control service	917
ANNEX XI — Part-FPD	918
SUBPART A — ADDITIONAL ORGANISATION REQUIREMENTS FOR PROVIDERS OF FLIGHT PROCEDURE DESIGN SERVICES (FPD.OR)	918
SECTION 1 — GENERAL REQUIREMENTS	918
FPD.OR.100 Flight procedure design (FPD) services	918
AMC1 FPD.OR.100 Flight procedure design (FPD) services	918
GM1 to AMC1 FPD.OR.100 Flight procedure design (FPD) services	918
GM1 FPD.OR.100 Flight procedure design (FPD) services	919
GM2 FPD.OR.100 Flight procedure design (FPD) services	919
GM3 FPD.OR.100 Flight procedure design (FPD) services	920
FPD.OR.105 Management system	920
GM1 FPD.OR.105 Management system	920
GM1 FPD.OR.105(a) Management system	920
AMC1 FPD.OR.105(c) Management system	921
GM1 FPD.OR.105(e) Management system	921
AMC1 FPD.OR.105(e) Management system	921

AMC2 FPD.OR.105(e) Management system.....	922
GM2 FPD.OR.105(e) Management system	922
FPD.OR.110 Record-keeping	923
FPD.OR.115 Technical and operational competence and capability	923
AMC1 FPD.OR.115(a)(1) Technical and operational competence and capability	923
GM1 FPD.OR.115(a)(1) Technical and operational competence and capability	924
GM2 FPD.OR.115(a)(1) Technical and operational competence and capability	924
GM3 FPD.OR.115(a)(1) Technical and operational competence and capability	924
AMC1 FPD.OR.115(a)(2) Technical and operational competence and capability	925
GM1 to AMC1 FPD.OR.115(a)(2) Technical and operational competence and capability	925
GM1 FPD.OR.115(a)(3) Technical and operational competence and capability	925
GM1 FPD.OR.115(b) Technical and operational competence and capability.....	925
FPD.OR.120 Required interfaces.....	926
GM1 FPD.OR.120 Required interfaces	926
SUBPART B — TECHNICAL REQUIREMENTS FOR PROVIDERS OF FLIGHT PROCEDURE DESIGN SERVICES (FPD.TR)	927
SECTION 1 — GENERAL REQUIREMENTS	927
FPD.TR.100 Flight procedure design requirements	927
AMC1 FPD.TR.100 Flight procedure design requirements	927
FPD.TR.105 Coordinates and aeronautical data	927
Appendix 1 — REQUIREMENTS FOR AIRSPACE STRUCTURES AND FLIGHT PROCEDURES CONTAINED THEREIN.....	928
SECTION I.....	928
Specifications for flight information regions, control areas, control zones and flight information zones	928
AMC1 SECTION I — (a) FLIGHT INFORMATION REGIONS.....	929
AMC1 SECTION I — (b) CONTROL AREAS	929
GM1 SECTION I — (b) CONTROL AREAS	929
AMC1 SECTION I — (c) CONTROL ZONES	929
GM1 SECTION I — (c) CONTROL ZONES	930
SECTION II.....	931
Identification of ATS routes other than standard departure and arrival routes .	931
AMC1 SECTION II.....	931
GM1 SECTION II.....	932
SECTION III.....	933
Identification of standard departure and standard arrival routes and associated procedures	933
AMC1 SECTION III — (a)(1).....	934
GM1 to AMC1 SECTION III — (a)(1).....	934
AMC1 SECTION III — (a)(2).....	934
AMC1 SECTION III — (b)(2).....	934
AMC1 SECTION III — (b)(5).....	935
GM1 SECTION III.....	935
SECTION IV.....	937
Establishment and identification of significant points.....	937
AMC1 SECTION IV	937
GM1 SECTION IV	939
SECTION V.....	940
Minimum flight altitudes.....	940
GM1 SECTION V	940
SECTION VI.....	941

Identification and delineation of prohibited, restricted and danger areas	941
AMC1 SECTION VI	941
GM1 SECTION VI	941
ANNEX XII — Part-NM.....	942
TECHNICAL REQUIREMENTS FOR THE NETWORK MANAGER (NM.TR).....	942
SECTION 1 — GENERAL REQUIREMENTS	942
NM.TR.100 Working methods and operating procedures for the Network Manager	942
Acceptable Means of Compliance (AMC) and Guidance Material (GM) to Part-NM Specific requirements for the Network Manager.....	943
ANNEX XIII — Part-PERS.....	944
SUBPART A —AIR TRAFFIC SAFETY ELECTRONICS PERSONNEL.....	944
SECTION 1 — GENERAL REQUIREMENTS	944
ATSEP.OR.100 Scope	944
GM1 ATSEP.OR.100 Scope	944
ATSEP.OR.105 Training and competence assessment programme	944
AMC1 ATSEP.OR.105 Training and competence assessment	945
GM1 to AMC1 ATSEP.OR.105(b) Training and competence.....	945
GM2 to AMC1 ATSEP.OR.105(b) Training and competence assessment programme.....	945
GM1 ATSEP.OR.105 Training and competence assessment programme	946
GM2 ATSEP.OR.105 Training and competence assessment programme	946
ATSEP.OR.110 Record-keeping	947
ATSEP.OR.115 Language proficiency.....	947
AMC1 ATSEP.OR.115 Language proficiency	947
SECTION 2 — TRAINING REQUIREMENTS	948
ATSEP.OR.200 Training requirements — General.....	948
GM1 ATSEP.OR.200 Training requirements — General	948
GM2 ATSEP.OR.200 Training requirements — General	949
GM1 ATSEP.OR.200(a) Training requirements — General.....	949
ATSEP.OR.205 Basic training	949
GM1 ATSEP.OR.205 Basic training	950
AMC1 ATSEP.OR.205(a) Basic training	950
AMC1 ATSEP.OR.205(a)(1) Basic training.....	950
AMC1 ATSEP.OR.205(a)(2) Basic training.....	950
GM1 ATSEP.OR.205(b) Basic training.....	950
ATSEP.OR.210 Qualification training.....	951
AMC1 ATSEP.OR.210 Qualification training	951
AMC2 ATSEP.OR.210 Qualification training	951
GM1 ATSEP.OR.210 Qualification training	951
AMC1 ATSEP.OR.210(a) Qualification training.....	951
GM1 ATSEP.OR.210(b) Qualification training.....	951
ATSEP.OR.215 System and equipment rating training.....	952
GM1 ATSEP.OR.215 System and equipment rating training	952
ATSEP.OR.220 Continuation training	952
AMC1 ATSEP.OR.220 Continuation training.....	952
GM1 ATSEP.OR.220 Continuation training.....	953
SECTION 3 — COMPETENCE ASSESSMENT REQUIREMENTS	954
ATSEP.OR.300 Competence assessment — General	954
GM1 ATSEP.OR.300(a) Competence assessment — General.....	954

ATSEP.OR.305 Assessment of initial and ongoing competence.....	954
GM1 ATSEP.OR.305(a)(1) Assessment of initial and ongoing competence.....	954
GM1 ATSEP.OR.305(a)(3) Assessment of initial and ongoing competence.....	955
GM1 ATSEP.OR.305(b)(2) Assessment of initial and ongoing competence	955
SECTION 4 — INSTRUCTORS AND ASSESSORS REQUIREMENTS	956
ATSEP.OR.400 ATSEP training instructors.....	956
ATSEP.OR.405 Technical skills assessors.....	956
AMC1 ATSEP.OR.405 Technical-skill assessors.....	956
GM1 ATSEP.OR.405 Technical skills assessors	956
GM2 ATSEP.OR.405 Technical-skill assessors.....	957
APPENDICES TO ANNEX XIII	958
Appendix 1 — Basic training — Shared.....	958
Appendix 1a — Basic training — Shared.....	959
Appendix 2 — Basic training — Streams.....	967
Appendix 2a — Basic training — Streams.....	968
Appendix 3 — Qualification training — Shared	985
Appendix 3a — Qualification training — Shared	987
Appendix 4 — Qualification training — Streams.....	1000
Appendix 4a — Qualification training — Streams	1021
Appendix 5a — General guidelines	1093

COVER REGULATION

COMMISSION IMPLEMENTING REGULATION (EU) 2017/373

of 1 March 2017

laying down common requirements for providers of air traffic management/air navigation services and other air traffic management network functions and their oversight, repealing Regulation (EC) No 482/2008, Implementing Regulations (EU) No 1034/2011, (EU) No 1035/2011 and (EU) 2016/1377 and amending Regulation (EU) No 677/2011

Regulation (EU) 2017/373

THE EUROPEAN COMMISSION,

Having regard to the Treaty on the Functioning of the European Union,

Having regard to [Regulation \(EC\) No 216/2008](#) of the European Parliament and of the Council of 20 February 2008 on common rules in the field of civil aviation and establishing a European Aviation Safety Agency, and repealing Council Directive 91/670/EEC, [Regulation \(EC\) No 1592/2002](#) and Directive 2004/36/EC¹, and in particular Article 8b(6) thereof,

Having regard to [Regulation \(EC\) No 550/2004](#) of the European Parliament and of the Council of 10 March 2004 on the provision of air navigation services in the single European sky (the service provision Regulation)², and in particular Articles 4 and 6 thereof,

Having regard to [Regulation \(EC\) No 551/2004](#) of the European Parliament and of the Council of 10 March 2004 on the organisation and use of the airspace in the single European sky (the airspace Regulation)³, and in particular Article 6(7) thereof,

Whereas:

- (1) Commission Implementing Regulations [\(EU\) No 1034/2011](#)⁴ and [\(EU\) No 1035/2011](#)⁵ lay down requirements on safety oversight in air traffic management and air navigation services and common requirements for the provision of air navigation services, respectively. Those latter requirements are to be complied with by the service providers concerned in order for them to be issued the certificates referred to in Article 7(1) of [Regulation \(EC\) No 550/2004](#) and Article 8b(2) of [Regulation \(EC\) No 216/2008](#). Those Regulations also lay down requirements concerning the competent authorities, which are responsible for issuing those certificates and exercising oversight and enforcement tasks, in accordance with Article 4 of [Regulation \(EC\) No 549/2004](#) of the European Parliament and of the Council⁶, Articles 2 and 7(7) of [Regulation \(EC\) No 550/2004](#) and Articles 10 and 22a of [Regulation \(EC\) No 216/2008](#).
- (2) The requirements set out in Implementing Regulations [\(EU\) No 1034/2011](#) and [\(EU\) No 1035/2011](#) serve in particular to implement, at an initial stage, the essential requirements concerning the provision of air traffic management and air navigation services ('ATM/ANS') set

¹ OJ L 79, 19.3.2008, p. 1.

² OJ L 96, 31.3.2004, p. 10.

³ OJ L 96, 31.3.2004, p. 20.

⁴ Commission Implementing Regulation (EU) No 1034/2011 of 17 October 2011 on safety oversight in air traffic management and air navigation services and amending Regulation (EU) No 691/2010 (OJ L 271, 18.10.2011, p. 15).

⁵ Commission Implementing Regulation (EU) No 1035/2011 of 17 October 2011 laying down common requirements for the provision of air navigation services and amending Regulations (EC) No 482/2008 and (EU) No 691/2010 (OJ L 271, 18.10.2011, p. 23).

⁶ Regulation (EC) No 549/2004 of the European Parliament and of the Council of 10 March 2004 laying down the framework for the creation of the single European Sky (OJ L 96, 31.3.2004, p. 1).

out in [Regulation \(EC\) No 216/2008](#), in particular to ensure compliance with Articles 8b and 22a of [Regulation \(EC\) No 216/2008](#) and Annex Vb thereto and to allow the commencement of standardisation inspections in accordance with Article 24 of [Regulation \(EC\) No 216/2008](#).

- (3) Those requirements set out in Implementing Regulations [\(EU\) No 1034/2011](#) and [\(EU\) No 1035/2011](#) should now be complemented and updated, in light of technical progress. It should also be clarified that, for service providers to be issued and retain a certificate, or to make a declaration, in accordance with this Regulation, they must comply, and continue to comply, with those requirements as well as with the essential requirements referred to in Article 8b(1) of [Regulation \(EC\) No 216/2008](#). In addition, consistency should be ensured between those requirements and the requirements set out in Commission Regulations [\(EU\) No 965/2012](#)¹, [\(EU\) No 1178/2011](#)², [\(EU\) No 139/2014](#)³ and [\(EU\) 2015/340](#)⁴, thus moving towards a 'total system approach', which entails a logical and technologically consistent approach across the various domains. Therefore, the requirements set out in Implementing Regulations [\(EU\) No 1034/2011](#) and [\(EU\) No 1035/2011](#) should now be laid down in a single instrument and Implementing Regulations [\(EU\) No 1034/2011](#) and [\(EU\) No 1035/2011](#) should be repealed.
- (4) Common rules for the certification and oversight of the service providers concerned are essential to increase the Member States' confidence in each other's systems. Therefore, and in order to ensure the highest level of safety and security, uniform requirements for the provision of services and their oversight should be strengthened. That should ensure the safe, high-quality provision of services for the purpose of air navigation and the mutual recognition of certificates throughout the Union, thereby increasing freedom of movement and improving the availability of those services.
- (5) In order to ensure a harmonised approach to certification and oversight, the measures to be implemented for security of systems, constituents in use and data should be coordinated across Member States, functional airspace blocks and the network formed by the services, functions and products offered by service providers, the Network Manager, aerodromes and other persons providing the necessary infrastructure for flight operations.
- (6) Safety management ensures the identification, assessment and minimisation of safety risks as well as security vulnerabilities which have an impact on safety. Therefore, it is necessary to further elaborate the requirements related to the safety assessment of changes to the functional system by a certified organisation. Those requirements should be adapted taking into account the integration of requirements relating to change management into the common regulatory structure for civil aviation safety, as well as the experience gained by stakeholders and competent authorities in the field of safety oversight.
- (7) It is appropriate to introduce safety culture as an aspect of the management systems of the service providers in a manner that promotes understanding and improvement of those systems,

¹ Commission Regulation (EU) No 965/2012 of 5 October 2012 laying down technical requirements and administrative procedures related to air operations pursuant to Regulation (EC) No 216/2008 of the European Parliament and of the Council (OJ L 296, 25.10.2012, p. 1).

² Commission Regulation (EU) No 1178/2011 of 3 November 2011 laying down technical requirements and administrative procedures related to civil aviation aircrew pursuant to Regulation (EC) No 216/2008 of the European Parliament and of the Council (OJ L 311, 25.11.2011, p. 1).

³ Commission Regulation (EU) No 139/2014 of 12 February 2014 laying down requirements and administrative procedures related to aerodromes pursuant to Regulation (EC) No 216/2008 of the European Parliament and of the Council (OJ L 44, 14.2.2014, p. 1).

⁴ Commission Regulation (EU) 2015/340 of 20 February 2015 laying down technical requirements and administrative procedures relating to air traffic controllers' licences and certificates pursuant to Regulation (EC) No 216/2008 of the European Parliament and of the Council, amending Commission Implementing Regulation (EU) No 923/2012 and repealing Commission Regulation (EU) No 805/2011 (OJ L 63, 6.3.2015, p. 1).

while acknowledging the need to strengthen management systems further, especially by integrating reliable occurrence reporting.

- (8) It should be specified which authorities are responsible for the tasks related to certification, oversight and enforcement in respect of the service providers that are subject to this Regulation, in line with the criterion set out in Article 7(2) of [Regulation \(EC\) No 550/2004](#) and the tasks of the European Aviation Safety Agency ('the Agency') pursuant to Article 22a of [Regulation \(EC\) No 216/2008](#), and without prejudice to the requirements of Article 2 of [Regulation \(EC\) No 550/2004](#). The Agency should be the competent authority for providers of data services and for the Network Manager, in light of the nature and scale of the services provided. In order to fulfil the objectives of [Regulation \(EC\) No 216/2008](#), in particular the objective set out in point (d) of Article 2(2) thereof, and the objective set out in Article 1(3) of [Regulation \(EC\) No 549/2004](#), it is also appropriate to align the requirements for the competent authorities with the progress in International Civil Aviation Organisation ('ICAO') safety management concepts, in particular the introduction of the authority management system, as well as in the implementation of the state safety programme and in ensuring coordination between those authorities.
- (9) It should be clarified that, when exercising their certification, oversight and enforcement tasks under this Regulation, the competent authorities should be independent from any service provider, through ensuring adequate separation of those authorities from those providers at least at the functional level, and that any possible conflict of interest should be avoided. The aim is to guarantee the objectivity and impartiality of those authorities and to ensure that the exercise of their tasks under this Regulation is of high quality.
- (10) The Agency should establish a database with relevant information relating to the competent authorities, so as to facilitate standardisation inspections of, and coordination with, the competent authorities, as well as to support the Commission in carrying out its tasks.
- (11) With a view to ensuring that the requirements for service providers set out in this Regulation are complied with at all times and the competent authorities can effectively exercise their tasks under this Regulation, in accordance with Article 4(3) and (4) of [Regulation \(EC\) No 549/2004](#), those authorities should be granted certain specific investigatory powers, in addition to the possibility to carry out investigations and surveys referred to in Article 2(2) of [Regulation \(EC\) No 550/2004](#) and Article 10(2) and (3) of [Regulation \(EC\) No 216/2008](#). It is appropriate to clarify that those powers should be exercised in accordance with the applicable rules of national law, while having due regard to a number of specific elements, which are meant to ensure a fair balance between all rights and interests at issue in a particular case.
- (12) The air traffic safety electronics personnel employed by a service provider or the Network Manager should be subject to a harmonised training and competence assessment scheme. The service provider or Network Manager should also ensure that the personnel of contracted organisations are appropriately qualified. Therefore, detailed provisions on training and competence assessment of such personnel should be included in this Regulation.
- (13) In order to ensure a high level of civil aviation safety in the Union, the measures set out in this Regulation should reflect the state of the art in aviation safety, including best practice and scientific and technical progress in the field of meteorological services. Therefore, this Regulation should be based on the applicable ICAO standards and recommended practices, specifically Annex 3 to the Convention on International Aviation, signed in Chicago on 7 December 1944 ('Chicago Convention') on 'Meteorological Service for International Air Navigation', while drawing on the experience of Union and worldwide meteorological service

provision and ensuring proportionality according to the size, type and complexity of the meteorological services provider.

- (14) Common requirements should be established for the certification and oversight of data services providers to ensure that the providers of aeronautical data for use on aircraft process the data in an appropriate manner, which meets the airspace end-users' requirements and allows for safe performance-based navigation operations.
- (15) The aeronautical industry and the competent authorities of the Member States should be allowed sufficient time to adapt to the new regulatory framework established by this Regulation and to replace certificates issued before the date of application of this Regulation.
- (16) However, in order to ensure consistency with [Regulation \(EU\) No 965/2012](#), the relevant provisions of this Regulation should apply to data services providers already from an earlier date. Moreover, those providers should be allowed, on a voluntary basis, to apply for, and be granted, the relevant certificates already immediately upon the entry into force of this Regulation, so as to allow them, as entities that are not subject to Implementing [Regulation \(EU\) No 1035/2011](#) but that are subject to the practice of issuing voluntary letters of acceptance by the Agency, to benefit from an early application of this Regulation in this regard and the mutual recognition of those certificates. Such early application of this Regulation with respect to data services providers would also relieve aircraft operators from their oversight responsibilities when contracting the services of those providers, once the provider is certified for aeronautical databases. Where such a provider makes use of that possibility, it should be bound by the applicable requirements of this Regulation for the purposes of obtaining a certificate and subsequently continue to be bound by those requirements. In view of this possibility for data service providers, the relevant provisions of this Regulation concerning the competent authority in respect of those providers, which is in this case only the Agency, should also apply already from the date of entry into force of this Regulation.
- (17) The provisions contained in Commission Implementing [Regulation \(EU\) No 923/2012](#)¹ should be complemented with aspects related to the provision of air traffic services, to ensure consistency of service provision with pilot and air traffic service personnel actions and requirements under that Regulation.
- (18) The safety acceptability of any change proposed by a service provider should be assessed based on the analysis of the risks posed by the introduction of a change to its functional system, differentiated under either quantitative or qualitative objective assessment criteria, or a combination of both, to be determined at a local level.
- (19) For reasons of consistency and ease of application, the provisions of Commission [Regulation \(EC\) No 482/2008](#)² should be integrated in this Regulation and Commission Regulation (EC) No 482/2008 should therefore be repealed.

¹ Commission Implementing Regulation (EU) No 923/2012 of 26 September 2012 laying down the common rules of the air and operational provisions regarding services and procedures in air navigation and amending Implementing Regulation (EU) No 1035/2011 and Regulations (EC) No 1265/2007, (EC) No 1794/2006, (EC) No 730/2006, (EC) No 1033/2006 and (EU) No 255/2010 (OJ L 281, 13.10.2012, p. 1).

² Commission Regulation (EC) No 482/2008 of 30 May 2008 establishing a software safety assurance system to be implemented by air navigation service providers and amending Annex II to Regulation (EC) No 2096/2005 (OJ L 141, 31.5.2008, p. 5).

- (20) The requirements of Articles 12 and 21 of Commission [Regulation \(EU\) No 677/2011](#)¹ and Annex VI thereto should be integrated in this Regulation in order to ensure a harmonised approach to all service providers. Therefore, those provisions should be deleted.
- (21) Commission Implementing [Regulation \(EU\) 2016/1377](#)², which has not yet become applicable, contains numerous errors. In order to eliminate those errors, while at the same time ensuring the required legal clarity, it is appropriate to repeal Implementing Regulation (EU) 2016/1377 in its entirety and to replace it with the rules set out in this Regulation.
- (22) The measures provided for in this Regulation are based on the opinion of the Agency in accordance with Articles 17(2)(b) and 19(1) of [Regulation \(EC\) No 216/2008](#).
- (23) The measures provided for in this Regulation are in accordance with the opinion of the Committee established by Article 5(3) of [Regulation \(EC\) No 549/2004](#),

HAS ADOPTED THIS REGULATION:

Article 1 Subject matter

Commission Implementing Regulation (EU) 2020/469

This Regulation lays down common requirements for:

- (a) the provision of air traffic management and air navigation services ('ATM/ANS') for general air traffic, in particular for the legal or natural persons providing those services and functions;
- (b) the competent authorities and the qualified entities acting on their behalf, which perform certification, oversight and enforcement tasks in respect of the services referred to in point (a);
- (c) the rules and procedures for the design of airspace structures.

GM1 Article 1 'Subject matter'

ED Decision 2017/001/R

SCOPE

In reference to the 'scope', please refer to [GM1 ATM/ANS.OR.A.001](#) 'Scope'.

GM2 Article 1 Subject matter

ED Decision 2020/008/R

DESIGN OF AIRSPACE STRUCTURES

- (a) Article 46 of Regulation (EU) 2018/1139 requires Member States to ensure that airspace structures are properly designed, surveyed and validated before they can be deployed and used by aircraft.
- (b) The designation of airspace is an obligation of the Member States, where civil and military national authorities are involved. The designation of airspace should include, but not be limited to, the design of airspace structure, the classification of the airspace and its approval.

¹ Commission Regulation (EU) No 677/2011 of 7 July 2011 laying down detailed rules for the implementation of air traffic management (ATM) network functions and amending Regulation (EU) No 691/2010 (OJ L 185, 15.7.2011, p. 1).

² Commission Implementing Regulation (EU) 2016/1377 of 4 August 2016 laying down common requirements for service providers and the oversight in air traffic management/air navigation services and other air traffic management network functions, repealing Regulation (EC) No 482/2008, Implementing Regulations (EU) No 1034/2011 and (EU) No 1035/2011 and amending Regulation (EU) No 677/2011 (OJ L 226, 19.8.2016, p. 1).

- (c) The (possible) certification and oversight of the design of airspace structure activities is left to the Member State discretion, if it wishes so and this Regulation provides only the design criteria that need to be met as laid down in Appendix 1 to Part-FPD.

Article 2 Definitions

Commission Implementing Regulation (EU) 2020/469

For the purposes of this Regulation, the definitions in Annex I and the following definitions shall apply:

- (1) the definitions in Article 2 of [Regulation \(EC\) No 549/2004](#) and Article 3 of [Regulation \(EC\) No 216/2008](#), except for the definition of ‘certificate’ in Article 2(15) of [Regulation \(EC\) No 549/2004](#);
- (2) ‘ATM/ANS provider’ means any legal or natural person providing any of the ATM/ANS as defined in Article 3 (5) of [Regulation \(EU\) 2018/1139](#), either individually or bundled, for general air traffic;
- (3) ‘Network Manager’ means the body established in accordance with Article 6 of [Regulation \(EC\) No 551/2004](#) to perform the duties provided for in that Article and in Articles 3 and 4 of [Regulation \(EU\) No 677/2011](#);
- (4) ‘pan-European service’ means an activity which is designed and established for users within most or all Member States and which may also extend beyond the airspace of the territory to which the Treaty applies;
- (5) ‘data services provider (DAT provider)’ means an organisation, which is:
 - (a) type 1 DAT provider that processes aeronautical data for use on aircraft and provides an aeronautical database meeting the DQRs, under controlled conditions, for which no corresponding airborne application/equipment compatibility has been determined;
 - (b) type 2 DAT provider that processes aeronautical data and provides an aeronautical database for use on certified aircraft application/equipment meeting the DQRs for which compatibility with that application/equipment has been determined.
- (6) ‘design of airspace structures’ means a process that ensures that airspace structures are properly designed, surveyed and validated before they are deployed and used by aircraft;
- (7) ‘airborne collision avoidance system (ACAS)’ means an aircraft system based on secondary surveillance radar (SSR) transponder signals which operates independently of ground-based equipment to provide advice to the pilot on potential conflicting aircraft that are equipped with SSR transponders;
- (8) ‘entity originating aeronautical data and aeronautical information’ – means any public or private entity responsible for origination of aeronautical data and aeronautical information used as a source for aeronautical information products and services. These entities do not include ATM/ANS providers referred to in point (2) of Article 2 of this Regulation and aerodromes defined in point (1)(e) of Article 2 of [Regulation \(EU\) 2018/1139](#).

GM1 Article 2 ‘Definitions’

ED Decision 2020/008/R

GENERAL

- (a) Point (5) of Article 3 of Regulation (EU) 2018/1139 defines ATM/ANS as ‘the air traffic management functions and services as defined in point 10 of Article 2 of [Regulation \(EC\) No 549/2004](#); the air navigation services defined in point 4 of Article 2 of that Regulation, including

the network management functions and services referred to in Article 6 of Regulation (EC) No 551/2004, as well as services which augment signals emitted by satellites of core constellations of GNSS for the purpose of air navigation; flight procedures design; and services consisting in the origination and processing of data and formatting and delivering data to general air traffic for the purpose of air navigation’.

- (b) It should, therefore, be noted that ‘ATM/ANS’ includes more services and functions than ‘air traffic management’ and ‘air navigation services’ together.
- (c) It is important to note that ATS is included in ATM and ANS.
- (d) As already defined, ‘ATM network functions’ refers to functions performed by the Network Manager in accordance with Regulation (EU) 2019/123.

Article 3 Provision of ATM/ANS and design of airspace structures

Commission Implementing Regulation (EU) 2020/469

1. Member States shall ensure that the appropriate ATM/ANS are provided and airspace structures are designed in accordance with this Regulation in a manner that facilitates general air traffic, while taking into account safety considerations, traffic requirements and environmental impact.
2. When Member States adopt additional provisions to complement this Regulation on any matters left to the Member States under this Regulation, those provisions shall follow the standards and recommended practices set by the Chicago Convention. Where use is made of the provisions of Article 38 of the Chicago Convention, in addition to notifying the International Civil Aviation Organisation, the Member States shall notify the European Aviation Safety Agency (‘Agency’), with due justification, at the latest two months after the additional provisions have been adopted.
3. Member States shall publish, in accordance with the Chicago Convention, those additional provisions through their aeronautical information publications.
4. Where a Member State decides to organise the provision of certain specific air traffic services in a competitive environment, that Member State shall take all appropriate measures to ensure that the providers of those services shall neither engage in conduct that would have as its object or effect the prevention, restriction or distortion of competition, nor shall they engage in conduct that amounts to an abuse of a dominant position, in accordance with applicable Union and national law.
5. Member States shall ensure that:
 - (a) entities originating aeronautical data or aeronautical information meet the requirements laid down in:
 - (i) point [ATM/ANS.OR.A.085](#) of Annex III, except those in points (c), (d), (f)(1) and (i) thereof;
 - (ii) point [ATM/ANS.OR.A.090](#) of Annex III;
 - (b) aeronautical data and aeronautical information are originated, processed and transmitted by adequately trained, competent and authorised personnel. When aeronautical data or aeronautical information is intended to be used for the purpose of IFR or special VFR flights, the requirements referred to in letters (a) and (b) of the first subparagraph shall apply to all entities originating such data and information.

6. Where it is determined that air traffic services are to be provided in particular portions of the airspace or at particular aerodromes, Member States shall ensure that those portions of the airspace or those aerodromes are specified in relation to the air traffic services that are to be provided.
7. Member States shall ensure that appropriate arrangements between the relevant ATM/ANS providers and aircraft operators are established for the adequate coordination of activities and services provided as well as for the exchange of relevant data and information.
8. Member States shall identify the persons or organisations, which are responsible for the design of airspace structures and shall ensure that those persons or organisations apply the requirements laid down in Appendix 1 to Annex XI (Part-FPD).
9. Member States shall ensure that maintenance and periodic review of flight procedures for aerodromes and airspace under their authority are conducted. For that purpose, Member States shall identify the persons or organisations, which are responsible for those tasks and shall ensure that the persons or organisations comply with the requirements laid down in [Article 6](#), points (a) and (k).

GM1 Article 3(1) Provision of ATM/ANS and design of airspace structures

ED Decision 2020/008/R

AIRSPACE STRUCTURE

Airspace structure refers to a specific volume of airspace designed to ensure the safe and optimal operation of aircraft. Airspace structures may consist of:

- (a) controlled airspace, namely control zones and control areas, including terminal control areas and airways or free route airspace;
- (b) airspace restrictions, namely danger, restricted, prohibited areas, temporary segregated areas and temporary reserved areas; and
- (c) other volumes of airspace as specified by the competent authority when defining the airspace change process, such as e.g. flight information zones, aerodrome traffic zone, RMZ/TMZ (XXX).

GM1 Article 3(5) Provision of ATM/ANS and design of airspace structures

ED Decision 2020/008/R

AERONAUTICAL INFORMATION — DATA ORIGINATION

- (a) In order to ensure that parties originating aeronautical data and aeronautical information that are neither subject to the applicable requirements in Regulation (EU) 2017/373 nor to the data quality requirements in Regulation (EU) No 139/2014, comply with the provisions relevant to them, Member States may consider establishment of measures, at national level, that such parties meet the aeronautical data quality management requirements laid down in point ATM/ANS.OR.A.085 of Annex III, except those in points (c), (d), (f)(1) and (i) thereof, and that their working methods and operating procedures comply with the requirements laid down in ATM/ANS.OR.A.090.
- (b) The objectives in point (a) may be achieved through continuous oversight by the competent authorities on the basis of which measures, at national level, a certificate or approval has been issued or a declaration by these parties has been made.

- (c) When a contract is agreed between the services provider and the parties originating aeronautical data and aeronautical information, it should clearly define the contracted activities and the applicable requirements, including the necessary certificate, approval or declaration as required.

AMC1 Article 3(6) Provision of ATM/ANS and design of airspace structures

ED Decision 2020/008/R

DESIGNATION

The designation of the particular portions of the airspace should be as follows:

- (a) flight information regions;
- (b) control areas and control zones; and
- (c) flight information zones.

AMC2 Article 3(6) Provision of ATM/ANS and design of airspace structures

ED Decision 2020/008/R

AERODROMES

The designation of the particular aerodromes should be as follows:

- (a) controlled aerodromes; and
- (b) aerodrome flight information services (AFIS) aerodromes.

GM1 to AMC2 Article 3(6) (a) Provision of ATM/ANS and design of airspace structures

ED Decision 2020/008/R

AERODROMES

The aerodrome traffic zone should be linked to controlled aerodromes as potential aerodrome delineation.

AMC3 Article 3(6) Provision of ATM/ANS and design of airspace structures

ED Decision 2020/008/R

AIRSPACE

Those portions of the airspace where it is determined that ATC service will be provided to IFR flights should be designated as control areas or control zones.

GM1 Article 3(6) Provision of ATM/ANS and design of airspace structures

ED Decision 2020/008/R

DESIGNATION — GENERAL

- (a) The airspace where air traffic services are provided is classified and designated in accordance with requirements found in Commission Implementing Regulation (EU) 923/2012, SERA.6001 'Classification of airspaces' and Appendix 4 'ATS airspace classes — services provided and flight requirements', and in the associated Acceptable Means of Compliance and Guidance Material.
- (b) The delineation of airspace, wherein air traffic services are to be provided, should be related to the nature of the route structure and the need for efficient service rather than to national boundaries.
- (c) In the context of the provision of air traffic services across national boundaries:
 - (1) agreements to permit the delineation of airspace lying across national boundaries are advisable, when such action will facilitate the provision of air traffic services; agreements, which permit delineation of airspace boundaries by straight lines, will, for example, be most convenient where data processing techniques are used by air traffic services units.
 - (2) where delineation of airspace is made by reference to national boundaries, there is a need for suitably sited transfer points to be mutually agreed upon.

GM1 Article 3(8) Provision of ATM/ANS and design of airspace structures

ED Decision 2020/008/R

GENERAL — PROCESS DESIGN OF AIRSPACE STRUCTURES AND FLIGHT PROCEDURES CONTAINED THEREIN

- (a) An airspace change is a change to an airspace structure.
- (b) The process for the airspace change should include the following elements:
 - (1) Initiation for an airspace change, including briefing by an initiator

DRIVERS FOR AIRSPACE CHANGES

Drivers for airspace changes include, but are not limited to, business, technological, legal and social aspects, such as:

- (i) enhancing operational safety and/or efficiency;
- (ii) meeting airspace capacity requirements;
- (iii) reducing the environmental impacts of aircraft operations;
- (iv) enabling changes to the CNS infrastructure; or
- (v) correcting identified deficiencies.

INITIATION

Initiator may be, but is not limited to, any of the following:

- (i) the Member State;
- (ii) the competent authority;
- (iii) an aerodrome operator;

- (iv) an ATM/ANS provider; or
- (v) an airspace user.

In undertaking an airspace change, the initiator:

- (i) proposes an airspace modification whilst ensuring that the airspace change satisfies and/or enhances safety, improves capacity and mitigates, as far as practicable, any environmental impacts in line with the applicable requirements and design criteria;
- (ii) follows the national airspace change processes, where specified; and
- (iii) identifies relevant stakeholders and conducts consultation(s).

- (2) Data collection
- (3) Initial proposal development
- (4) Consultation with affected stakeholders

Affected stakeholders should be considered to be, but not limited to:

- (i) ATM/ANS providers;
- (ii) airspace users (including military);
- (iii) aerodrome operators;
- (iv) State's authorities;
- (v) other groups affected by the airspace change (e.g. local municipalities, environmental organisations, adjacent States, etc.).

The initiator should ensure that an assessment is carried out before deploying the airspace change.

If a change to the airspace results in a change to the functional system(s) of the ATS providers serving the affected airspace, those affected ATS providers need to perform a safety assessment as per ATS.OR.205 of this Regulation.

- (5) Design and documentation
- (6) Validation

The airspace change may be validated using one or more of the following methodologies:

- (i) airspace modelling;
- (ii) ATC simulation;
- (iii) live trials;
- (iv) flight simulation;
- (v) data analytical tools;
- (vi) statistical analysis;
- (vii) collision risk modelling; and
- (viii) noise and emissions modelling.

(7) State's approval,

The airspace change proposal should be submitted to the State's authority for assessment addressing the following, as applicable:

- (i) Operational requirements
 - (A) Justification for the change;
 - (B) Technical description of the change:
 - (a) airspace description;
 - (b) traffic forecasts;
 - (c) supporting infrastructure/resources;
 - (d) operational impact;
 - (e) supporting maps, charts and diagrams; and
 - (f) airspace and infrastructure requirements; and
 - (C) Validation report.
- (ii) Assessment report
- (iii) Environmental report
- (iv) Consultation report
- (v) Implementation plan
 - (A) Target implementation date and alternative date (or dates), taking due account of the predetermined agreed AIRAC dates in addition to the time needed by the AIS provider for the preparation, production and issuance of relevant material for promulgation; and
 - (B) Planned awareness and education activities.
- (vi) Economic impact.

(8) Implementation of the airspace change

The initiator should implement those aspects of the airspace change that are under its remit; however, the implementation of the airspace change may require other stakeholders implementing changes in their services.

The implementation of the airspace change could include amendment in the aeronautical information publication (AIP), changes in the procedures of the ATS providers, etc.

- (9) Post implementation review
- (10) Maintenance and periodic review

GM2 Article 3(8) Provision of ATM/ANS and design of airspace structures

ED Decision 2020/008/R

GENERAL — INTERACTIONS BETWEEN AIRSPACE CHANGE PROCESS AND FLIGHT PROCEDURE DESIGN PROCESS

When an airspace change includes the design of a new flight procedure or the modification of an existing flight procedure and the initiator is at the same time the flight procedure design service provider, both processes might run in parallel.

When the initiator is a different organisation than the flight procedure design service provider, this flight procedure design process can be regarded as a sub-process of the wider process as depicted in Figure 1.

Figure 1 shows the interactions between the airspace change process and the flight procedure design process.

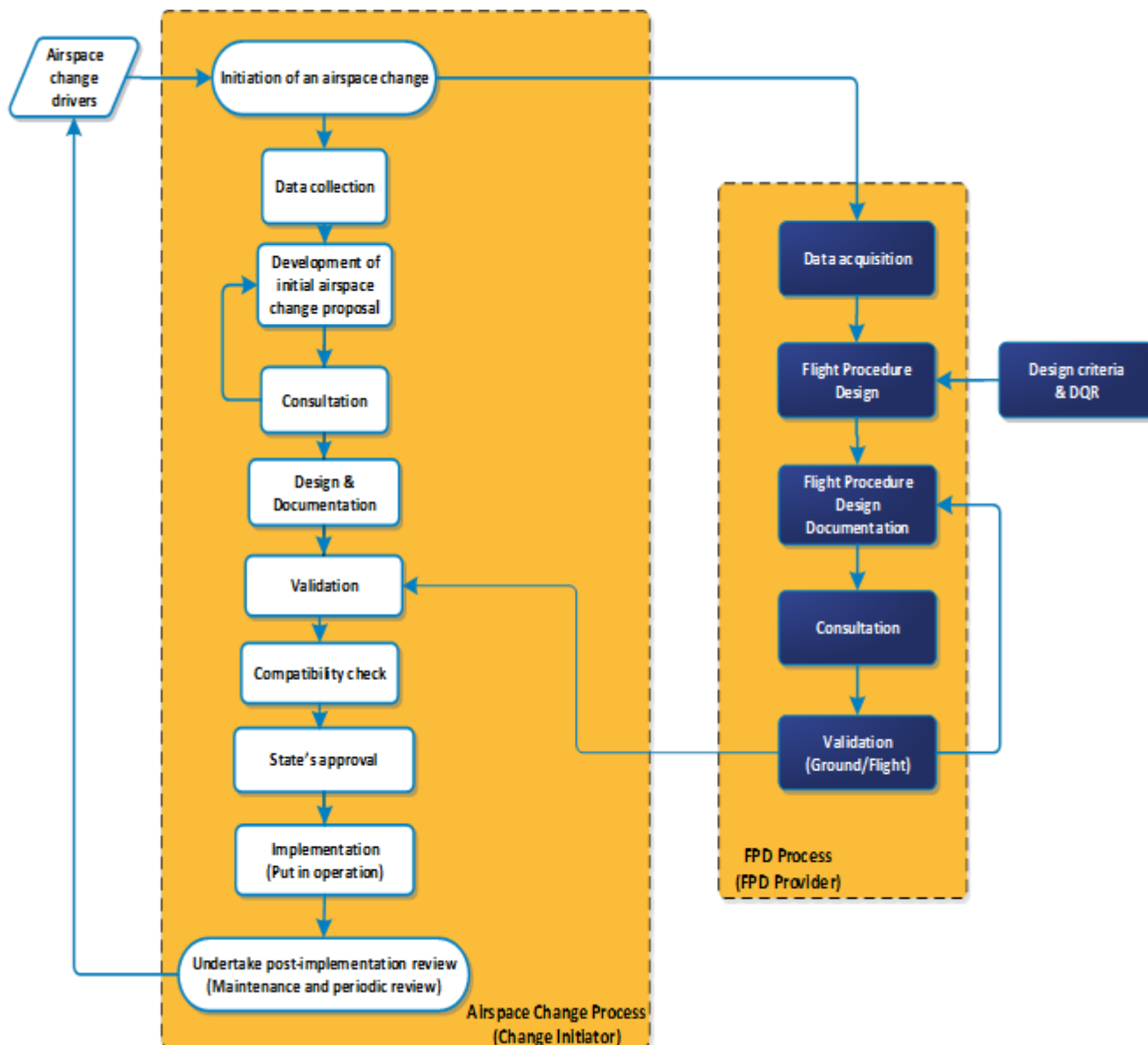
Figure 1: Interactions between airspace change process and flight procedure design process

[...]

AMC1 Article 3(9) Provision of ATM/ANS and design of airspace structures

ED Decision 2020/008/R

PERIODIC REVIEW

Periodic review should be conducted at an interval not exceeding 5 years.

Article 3a Determination of the need for the provision of air traffic services

Commission Implementing Regulation (EU) 2020/469

1. Member States shall determine the need for the provision of air traffic services by taking into account all of the following factors:
 - (a) the types of air traffic involved;
 - (b) the density of air traffic;
 - (c) the meteorological conditions;
 - (d) other relevant factors related to the objectives of the air traffic services defined in point [ATS.TR.100](#) of [Annex IV](#).
2. While determining the need for the provision of air traffic services Member States shall not take into account the carriage of airborne collision avoidance systems by aircraft.

GM1 Article 3a(1) Determination of the need for the provision of air traffic services

ED Decision 2020/008/R

ELEMENTS TO DETERMINE THE NEED FOR AIR TRAFFIC SERVICES PROVISION

The determination of the need for air traffic services provision in a given area and/or aerodrome may be subject to consideration and evaluation of a great number and typology of elements, such as:

- (a) a mixture of different types of air traffic with aircraft of varying speeds (conventional, jet, etc.) might necessitate the air traffic services provision, whereas a relatively greater density of traffic where only one type of operation is involved would not;
- (b) meteorological conditions might have considerable effect in areas where there is a constant flow of air traffic (e.g. scheduled traffic), whereas similar or worse meteorological conditions might be relatively unimportant in an area where air traffic would be discontinued in such conditions (e.g. local visual flight rules (VFR) flights);
- (c) open stretches of water, mountainous, uninhabited or desert areas might necessitate the air traffic services provision even though the frequency of operations is extremely low;
- (d) the complexity of the airspace concerned; and
- (e) the language(s) to be used in air-ground communications, in the case of AFIS.

GM2 Article 3a(1) Determination of the need for the provision of air traffic services

ED Decision 2020/008/R

NON-ATS (AIR TRAFFIC SERVICES) AERONAUTICAL STATIONS

(a) Description of non-ATS aeronautical stations

Where a Member State determines that no requirement exists for the air traffic services provision at an aerodrome and its vicinity or in other airspace, a universal communication (UNICOM)-type aeronautical station may be established (with call signs like RADIO, UNICOM, name of the aero club, etc.). Such a station should be established following the Member State

arrangements, to facilitate the activities of aircraft (for example, a frequency used by pilots to announce their intentions at an aerodrome where air traffic services are not provided).

It may be established in an airspace where Member States have decided that whilst en-route flight information service will be provided by a designated and certified flight information service provider, there is no requirement for mandatory two-way radio communication. In such cases, the Member State should ensure that the aeronautical station does not provide air traffic services, but acts as an informal facility for exchanges on, for example, aerodrome conditions or other activities at the aerodrome.

(b) Promulgation of information for non-ATS aeronautical stations

The arrangements established for non-ATS aeronautical stations should ensure that information regarding their availability are included in the relevant parts of the AIP. The information should include, as a minimum, the following:

- (1) identification of the aerodrome, where applicable;
- (2) location and identification of the aeronautical station, where applicable;
- (3) hours of operation of the aeronautical station, where applicable;
- (4) language(s) used;
- (5) detailed description of the facilitation provided and its limitations;
- (6) special procedures for application by pilots; and
- (7) any other pertinent information.

(c) Identification of non-ATS aeronautical stations

Where a non-ATS aeronautical station is established:

- (1) the station should normally be identified by the name of the aerodrome at which they are providing air-ground or air-air communication, or by the name of a nearby town or city or geographic feature or area, or by the name of the aero club it facilitates; and
- (2) the name of the station should be complemented by the suffix 'RADIO', as established in Section 5.2.1.7.1.2 of ICAO Annex 10 Volume II.

Article 3b Coordination between military units and air traffic service providers

Commission Implementing Regulation (EU) 2020/469

Without prejudice to Article 6 of Regulation (EC) No 2150/2005, Member States shall establish special procedures so that:

- (a) air traffic service providers are notified if a military unit observes that an aircraft, which is, or might be, a civil aircraft is approaching, or has entered, any area in which interception might become necessary;
- (b) the air traffic service provider shall in close coordination with the military unit confirm the identity of the aircraft and provide it with the navigational guidance necessary to avoid the need for interception.

GM1 to Article 3b(b) Coordination between military authorities and air traffic service providers

ED Decision 2020/008/R

The requirement is generic and includes but is not limited to the need to designate areas or routes where the requirements concerning flight plans, two-way communications and position reporting are applicable to all flights. This should be done to ensure that all pertinent data is available for the use of the appropriate air traffic services units specifically for the purpose of facilitating identification of civil aircraft and thus of eliminating or reducing the need for interceptions.

Article 3c Coordination of air operations potentially hazardous to civil aviation

Commission Implementing Regulation (EU) 2020/469

1. Member States shall ensure that operations potentially hazardous to civil aircraft over their territory are coordinated, including over the high seas, in case the competent authority has accepted, pursuant to an ICAO Regional Air Navigation Agreement, the responsibility to provide air traffic services within the airspace concerned. The coordination shall be effected early enough to permit timely promulgation of information regarding those activities.
2. Member States shall establish arrangements for the promulgation of information regarding the activities referred to in paragraph 1.

GM2 Article 3c(1) Coordination of air operations potentially hazardous to civil aviation

ED Decision 2020/008/R

COORDINATION OF MILITARY ACTIVITIES POTENTIALLY HAZARDOUS TO CIVIL AVIATION

Guidance for the coordination of such activities is provided in ICAO Doc 9554 'Manual Concerning Safety Measures Relating to Military Activities Potentially Hazardous to Civil Aircraft Operations'.

GM1 Article 3c(2) Coordination of air operations potentially hazardous to civil aviation

ED Decision 2020/008/R

In determining these arrangements, the following should be applied:

- (a) the locations or areas, times and durations for the activities should be selected to avoid closure or realignment of established air traffic services routes, blocking of the most economic flight levels, or delays of scheduled aircraft operations, unless no other options exist;
- (b) the size of the airspace designated for the conduct of the activities should be kept as small as possible; and
- (c) direct communication between the appropriate air traffic services unit(s) and the organisation or unit conducting the activities should be provided for use in the event that civil aircraft emergencies or other unforeseen circumstances require discontinuation of the activities.

Article 3d Very-high frequency (VHF) emergency frequency

Commission Implementing Regulation (EU) 2020/469

1. Without prejudice to paragraph 2, Member States shall ensure that the VHF emergency frequency (121,500 MHz) is only used for genuine emergency purposes as specified in point [ATS.OR.405\(a\)](#) of [Annex IV](#).
2. Member States may exceptionally allow the use of the VHF emergency frequency referred to in paragraph 1 for other purposes than those specified in point [ATS.OR.405\(a\)](#) of [Annex IV](#), if those are limited to the extent necessary to achieve their aim and in order to reduce the impact upon aircraft in distress or emergency and upon the operations of air traffic services units.

GM1 Article 3d(2) Very-high frequency (VHF) emergency frequency

ED Decision 2020/008/R

When Member States consider the possibility to allow the use of the VHF emergency frequency for other activities related to the intended use of this frequency (e.g. for training), consideration should be given to the impact on the operations of the air traffic services units located in the neighbouring States, in order to prevent triggering unnecessary actions related to the use of the emergency frequency.

Article 4 Competent authority for certification, oversight and enforcement

Regulation (EU) 2017/373

1. The competent authority responsible for the issuing of certificates to service providers, for the acknowledgment of receipts of declarations made by providers of flight information services referred to in [Article 7](#) where relevant, and for the oversight and enforcement in respect of service providers shall be the national supervisory authority referred to in Article 4 of [Regulation \(EC\) No 549/2004](#) of the Member State where the legal or natural person applying for the certificate or making the declaration has its principal place of operation or, if any, its registered office, unless the Agency is the competent authority pursuant to Article 22a of [Regulation \(EC\) No 216/2008](#).

For the purposes of this Regulation, data services providers and the Network Manager shall be considered to be pan-European service providers in respect of which, in accordance with point (c) of Article 22a of [Regulation \(EC\) No 216/2008](#), the Agency is the competent authority.

2. The competent authorities referred to in paragraph 1 shall comply with the requirements laid down in [Annex II](#).
3. Where one of the service providers concerned is an organisation in respect of which the Agency is the competent authority, the competent authorities of the Member States concerned shall coordinate with the Agency in order to ensure that the requirements set out in points (1), (2) and (3) of point [ATM/ANS.AR.A.005\(b\)](#) of [Annex II](#) are complied with where, alternatively:
 - (a) service providers provide services in respect of functional airspace blocks that extend across the airspace falling under the responsibility of more than one Member State, as referred to in Article 2(3) of [Regulation \(EC\) No 550/2004](#);
 - (b) service providers provide cross-border air navigation services as referred to in Article 2(5) of [Regulation \(EC\) No 550/2004](#).

4. Where a Member State has nominated or established more than one competent authority in accordance with Article 4 of [Regulation \(EC\) No 549/2004](#) or as referred to in Article 2(3) to (6) of [Regulation \(EC\) No 550/2004](#) to exercise the certification, oversight and enforcement tasks under this Regulation, it shall ensure that the areas of competence of each of those authorities are clearly defined, in particular in terms of responsibilities and geographic and airspace limitation. In such a case, those authorities shall establish coordination between them, based on written arrangements, so as to ensure effective oversight and enforcement in respect of all service providers to which they issued certificates or, where relevant, which made declarations to them.
5. When exercising their certification, oversight and enforcement tasks under this Regulation, the competent authorities shall be independent of any service provider. That independence shall be ensured by adequate separation, at least at the functional level, between the competent authorities and the service providers. In this context, Member States shall ensure that the competent authorities exercise their powers impartially and transparently.
6. Member States and, where the Agency is the competent authority, the Commission shall ensure that their competent authorities do not allow their personnel to be involved in the exercise of the certification, oversight and enforcement tasks of that authority under this Regulation where there are indications that such involvement could result, directly or indirectly, in a conflict of interest, in particular relating to family or financial interests.
7. The Agency shall maintain a database of contact details of the competent authorities referred to in paragraph 1. For this purpose, Member States shall notify the Agency of the names and addresses of their competent authorities, and of any subsequent changes thereto.
8. Member States and, where the Agency is the competent authority, the Commission shall determine the necessary resources and capabilities required by the competent authorities for the exercise of their tasks, in accordance with Article 4(4) of [Regulation \(EC\) No 549/2004](#) and Article 22a of [Regulation \(EC\) No 216/2008](#), taking into account all relevant factors, including an assessment carried out by the respective competent authorities to determine the resources needed for the exercise of their tasks under this Regulation.

GM1 Article 4(5) 'Competent authority for certification, oversight and enforcement'

ED Decision 2017/001/R

SEPARATION AT THE FUNCTIONAL LEVEL

'Functional level separation' means that a competent authority may be engaged in operational activities and the oversight of organisations in the same domain, provided that the different functions are clearly separated and that the organisational governance ensures effective oversight by avoiding conflicts of interest by personnel and preventing their engagement in operational activities of the entities that they are meant to oversee. This could be achieved by applying appropriate management and control mechanisms.

GM2 Article 4(5) 'Competent authority for certification, oversight and enforcement'

ED Decision 2017/001/R

SEPARATION AT THE FUNCTIONAL LEVEL

When achieving independence between the competent authority and the service provider(s) through functional level separation, the Member State should ensure that:

- (a) the responsibility for the service provision and the responsibility for the certification, receipt of declarations and oversight activities are allocated to separate personnel;
- (b) the former should not have any control over the latter; and
- (c) this happens within a just culture environment.

AMC1 Article 4(8) 'Competent authority for certification, oversight and enforcement'

ED Decision 2017/001/R

REGULARITY OF THE ASSESSMENT CARRIED OUT BY THE COMPETENT AUTHORITY

The competent authorities should establish, and update every two years, an assessment of the resources needed to effectively exercise their certification, oversight and enforcement tasks under this Regulation, based on an analysis of the processes and other measures necessary to that end.

Article 5 Powers of the competent authority referred to in Article 4

Regulation (EU) 2017/373

1. The competent authorities shall, where required for the exercise of their certification, oversight and enforcement tasks under this Regulation, be empowered to:
 - (a) require the service providers subject to their oversight to provide all necessary information;
 - (b) require any representative, manager or other member of the personnel of those service providers to provide oral explanations on any fact, document, object, procedure or other subject matter relevant to the oversight of the service provider;
 - (c) enter any premises and land, including operating sites, and means of transport of those service providers;
 - (d) examine, copy or make extracts from any document, record or data held by or accessible to those service providers, irrespective of the medium on which the information in question is stored;
 - (e) carry out audits, assessments, investigations and inspections of those service providers.
2. The competent authorities shall, where required for the exercise of their certification, oversight and enforcement tasks under this Regulation, also be empowered to exercise the powers set out in paragraph 1 in relation to the contracted organisations subject to the service providers' oversight, as referred to in point [ATM/ANS.OR.B.015](#) of [Annex III](#).
3. The powers provided for in paragraphs 1 and 2 shall be exercised in compliance with the national law of the Member State where the activities in question take place, with due regard for the need to ensure the effective exercise of those powers and for the rights and legitimate interests of the service provider and any third persons concerned, and in compliance with the

principle of proportionality. Where, in accordance with the applicable national law, prior authorisation from the judicial authority of the Member State concerned is needed to enter premises, land and means of transport as referred to in point (c) of paragraph 1, the related powers shall be exercised only after having obtained such prior authorisation.

When exercising the powers provided for in paragraphs 1 and 2, the competent authority shall ensure that the members of its staff and, where relevant, any other expert participating in the activities in question are duly authorised.

4. The competent authorities shall take or initiate any appropriate enforcement measure necessary to ensure that the service providers to which they issued a certificate or, where relevant, which made a declaration to them, comply and continue to comply with the requirements of this Regulation.

AMC1 Article 5 'Powers of the competent authority referred to in Article 4'

ED Decision 2017/001/R

ASSESSMENTS AND INVESTIGATIONS

Investigations and assessments should include tests and exercises as determined by the competent authority.

Article 6 Service providers

Commission Implementing Regulation (EU) 2020/469

Service providers shall be granted a certificate and be entitled to exercise the privileges granted within the scope of that certificate, where, in addition to the requirements referred to in Article 8b(1) of [Regulation \(EC\) No 216/2008](#), they comply and continue to comply with the following requirements:

- (a) for all service providers, the requirements laid down in [Annex III](#) (Part-ATM/ANS.OR), Subparts A and B, and in [Annex XIII](#) (Part-PERS);
- (b) for service providers other than providers of air traffic services, in addition to the requirements of point (a), the requirements laid down in [Annex III](#) (Part-ATM/ANS.OR), Subpart C;
- (c) for providers of air navigation services, providers of air traffic flow management and the Network Manager, in addition to the requirements of point (a), the requirements laid down in [Annex III](#) (Part-ATM/ANS.OR), Subpart D;
- (d) for providers of air traffic services, in addition to the requirements of points (a) and (c), the requirements laid down in [Annex IV](#) (Part-ATS) and the requirements laid down in Regulation (EU) No 923/2012;
- (e) for providers of meteorological services, in addition to the requirements of points (a), (b) and (c), the requirements laid down in [Annex V](#) (Part-MET);
- (f) for providers of aeronautical information services, in addition to the requirements of points (a), (b) and (c), the requirements laid down in [Annex VI](#) (Part-AIS);
- (g) for data services providers, in addition to the requirements of points (a) and (b), the requirements laid down in [Annex VII](#) (Part-DAT);
- (h) for providers of communication, navigation or surveillance services, in addition to the requirements of points (a), (b) and (c), the requirements laid down in [Annex VIII](#) (Part-CNS);

- (i) for providers of air traffic flow management, in addition to the requirements of points (a), (b) and (c), the requirements laid down in [Annex IX](#) (Part-ATFM);
- (j) for providers of airspace management, in addition to the requirements of points (a) and (b), the requirements laid down in [Annex X](#) (Part-ASM);
- (k) for providers of flight procedure design services, in addition to the requirements of points (a) and (b), the requirements laid down in [Annex XI](#) (Part-FPD);
- (l) for the Network Manager, in addition to the requirements of points (a), (b) and (c), the requirements laid down in [Annex XII](#) (Part-NM).

GM1 Article 6 ‘Service providers’

ED Decision 2017/001/R

PROVISION OF ATFM AND/OR ASM

- (a) In most cases, the provision of ATFM and/or ASM takes place in a bundled service performed by the ATS providers. However, the provision of ATFM and/or ASM as a bundled service is not a legal requirement.
- (b) Initially under the single European sky (SES) I initiative in 2004 with the adoption of [Regulation \(EC\) No 549/2004](#), functions were not subject to certification; they were only subject to continuous oversight. This difference between functions and services was removed in the 2009 with the SESII initiative and the amendments to [Regulation \(EC\) No 216/2008](#) (the EASA Basic Regulation), with the effect that the two concepts now have an identical certification and oversight regime.

Article 7 Declaration by providers of flight information services

Regulation (EU) 2017/373

Where Member States allow providers of flight information services to declare their capability and means of discharging the responsibilities associated with the services provided in accordance with Article 8b(3) of [Regulation \(EC\) No 216/2008](#), those providers shall fulfil, in addition to the requirements referred to in Article 8b(1) of Regulation (EC) No 216/2008, the requirements laid down in point [ATM/ANS.OR.A.015](#) in [Annex III](#) to this Regulation.

Article 8 Existing certificates

Regulation (EU) 2017/373

1. Certificates that have been issued in accordance with Implementing [Regulation \(EU\) No 1035/2011](#) shall be deemed to have been issued in accordance with this Regulation.
2. Member States shall replace the certificates referred to in paragraph 1 with certificates complying with the format laid down in Appendix 1 to [Annex II](#) by 1 January 2021 at the latest.

Article 9 Repeal and amendment

Regulation (EU) 2017/373

1. [Regulation \(EC\) No 482/2008](#) and Implementing Regulations [\(EU\) No 1034/2011](#) and [\(EU\) No 1035/2011](#) are repealed.
2. Implementing [Regulation \(EU\) 2016/1377](#) is repealed.
3. Articles 12 and 21 of [Regulation \(EU\) No 677/2011](#) and Annex VI to that Regulation are deleted.

Article 10 Entry into force

Regulation (EU) 2017/373

This Regulation shall enter into force on the twentieth day following that of its publication in the Official Journal of the European Union.

It shall apply from 2 January 2020.

However:

- (1) [Article 9\(2\)](#) shall apply from the date of entry into force of this Regulation;
- (2) in respect of the Agency, [Article 4\(1\), \(2\), \(5\), \(6\) and \(8\)](#) and [Article 5](#) shall apply from the date of entry into force of this Regulation;
- (3) in respect of data services providers, [Article 6](#) shall apply in any case from 1 January 2019 and, where such a provider applies for and is granted a certificate in accordance with Article 6, from the date of entry into force of this Regulation.

This Regulation shall be binding in its entirety and directly applicable in all Member States.

GM1 Article 10 'Entry into force'

ED Decision 2017/001/R

DAT PROVIDERS

In respect of DAT providers, [Regulation \(EU\) 2017/373](#) applies from 1 January 2019.

However, DAT providers are allowed, on a voluntary basis, to apply for, and be granted, the relevant certificates upon the entry into force of this Regulation (before 1 January 2019).

Where a DAT provider makes use of this possibility and is issued a certificate, it is bound by the applicable requirements of this Regulation.

Until 1 January 2019, DAT providers may continue to apply for the issuance of a Letter of Acceptance (LoA) by the Agency, in accordance with the terms and conditions set out in EASA Opinion 1/2005 issued on 21 January 2005.

Regulation (EU) 2017/343

Done at Brussels, 1 March 2017.

For the Commission
The President
Jean-Claude JUNCKER

ANNEX I — PART-DEFINITIONS

Regulation (EU) 2021/665

For the purposes of Annexes II to XIII, the following definitions shall apply:

- (1) ‘acceptable means of compliance (AMC)’ means non-binding standards adopted by the Agency to illustrate means to establish compliance with [Regulation \(EC\) No 216/2008](#) and its implementing rules;
- (2) ‘aerial work’ means an aircraft operation in which an aircraft is used for specialised services such as agriculture, construction, photography, surveying, observation and patrol, search and rescue or aerial advertisement;
- (3) ‘aerodrome climatological summary’ means a concise summary of specified meteorological elements at an aerodrome, based on statistical data;
- (4) ‘aerodrome climatological table’ means a table providing statistical data on the observed occurrence of one or more meteorological elements at an aerodrome;
- (5) ‘aerodrome elevation’ means the elevation of the highest point of the landing area;
- (6) ‘aerodrome flight information service (AFIS)’ means flight information service for aerodrome traffic provided by a designated air traffic services provider;
- (7) ‘aerodrome meteorological office’ means an office responsible for providing meteorological service for an aerodrome;
- (8) ‘aerodrome warning’ means information issued by an aerodrome meteorological office concerning the occurrence or expected occurrence of meteorological conditions which could adversely affect aircraft on the ground, including parked aircraft and the aerodrome facilities and services;
- (9) ‘aeronautical data’ means a representation of aeronautical facts, concepts or instructions in a formalised manner suitable for communication, interpretation or processing;
- (10) ‘aeronautical database’ means a collection of aeronautical data organised and arranged as a structured data set, stored electronically on systems, which is valid for a dedicated period and may be updated;
- (11) ‘aeronautical fixed service (AFS)’ means a telecommunication service between specified fixed points provided primarily for the safety of air navigation and for the regular, efficient and economical operation of air services;
- (12) ‘aeronautical fixed telecommunication network (AFTN)’ means a worldwide system of aeronautical fixed circuits provided, as part of the AFS, for the exchange of messages and/or digital data between aeronautical fixed stations having the same or compatible communications characteristics;
- (13) ‘aeronautical information’ means information resulting from the assembly, analysis and formatting of aeronautical data;
- (14) ‘aerodrome mapping data’ means data collected for the purpose of compiling aerodrome mapping information;
- (15) ‘aerodrome mapping database (AMDB)’ means a collection of aerodrome mapping data organised and arranged as a structured data set;

-
- (16) 'aeronautical meteorological station' means a station making observations and meteorological reports for use in air navigation;
- (17) 'air-report' means a report from an aircraft in flight prepared in conformity with the requirements for position and operational and/or meteorological reporting;
- (18) 'aircraft' means any machine that can derive support in the atmosphere from the reactions of the air other than the reactions of the air against the earth's surface;
- (19) 'AIRMET' means information issued by a meteorological watch office concerning the occurrence or expected occurrence of specified en-route weather phenomena which may affect the safety of low-level aircraft operations and of the development of those phenomena in time and space, and which was not already included in the forecast issued for low-level flights in the flight information region concerned or sub-area thereof;
- (20) 'air traffic safety electronics personnel (ATSEP)' means any authorised personnel who are competent to operate, maintain, release from, and return into operations equipment of the functional system;
- (21) 'air traffic services unit' is a generic term meaning variously air traffic control unit, flight information centre, aerodrome flight information service unit or air traffic services reporting office;
- (22) 'alternate aerodrome' means an aerodrome to which an aircraft may proceed when it becomes either impossible or inadvisable to proceed to or to land at the aerodrome of intended landing where the necessary services and facilities are available, where aircraft performance requirements can be met and which is operational at the expected time of use;
- (23) 'alternative means of compliance (AltMOC)' means those means of compliance that propose an alternative to an existing AMC or those that propose new means to establish compliance with [Regulation \(EC\) No 216/2008](#) and its Implementing Rules for which no associated AMC have been adopted by the Agency;
- (24) 'altitude' means the vertical distance of a level, a point, or an object considered as a point, measured from mean sea level;
- (25) 'area control centre (ACC)' means a unit established to provide air traffic control service to controlled flights in control areas under its jurisdiction;
- (26) 'area forecast for low-level flights' means a forecast of weather phenomena for a flight information region or sub-area thereof, issued to cover the layer below flight level 100 (or below flight level 150 in mountainous areas, or higher, where necessary);
- (27) 'area navigation (RNAV)' means a method of navigation which permits aircraft operation on any desired flight path within the coverage of ground- or space-based navigation aids or within the limits of the capability of self-contained aids, or a combination of them;
- (28) 'argument' means a claim that is supported via inferences by a body of evidence;
- (29) 'ASHTAM' means a special series of NOTAM notifying by means of a specific format of a change in the activity of a volcano, a volcanic eruption and/or volcanic ash cloud that is of significance to aircraft operations;
- (30) 'ATM network functions' means the functions performed by the Network Manager in accordance with [Regulation \(EU\) No 677/2011](#);
- (31) 'audit' means a systematic, independent and documented process for obtaining evidence and evaluating it objectively to determine the extent to which requirements are complied with;

-
- (32) 'authoritative source' means:
- (a) a State authority; or
 - (b) an organisation formally recognised by the State authority to originate and/or publish data which meets the data quality requirements (DQRs) as specified by that State;
- (33) 'automatic observing system' means an observing system that measures, derives and reports all required elements without human interaction;
- (34) 'aviation undertaking' means an entity, person or organisation, other than the service providers regulated by this Regulation, that is affected by or affects a service delivered by a service provider;
- (35) 'break' means a period of time within the duty period when an air traffic controller is not required to perform duties, for recuperation purposes;
- (36) 'certified aircraft application' means a software application approved by the Agency as part of aircraft subject to Article 4 of [Regulation \(EC\) No 216/2008](#);
- (37) 'cloud of operational significance' means a cloud with the height of cloud base below 5 000 ft or below the highest minimum sector altitude, whichever is greater, or a cumulonimbus cloud or a towering cumulus cloud at any height;
- (38) 'commercial air transport' means any aircraft operation involving the transport of passengers, cargo or mail for remuneration or other valuable consideration;
- (38a) 'conventional navigation route' means an ATS route established by reference to ground navigation aids;
- (39) 'control area' means a controlled airspace extending upwards from a specified limit above the earth;
- (40) 'critical incident stress' means the manifestation of unusual and/or extreme emotional, physical and/or behavioural reactions of an individual following an event or incident;
- (41) 'data quality' means a degree or level of confidence that the provided data meets the user's data requirements in terms of accuracy, resolution, integrity (or equivalent assurance level), traceability, timeliness, completeness, and format;
- (42) 'data quality requirements (DQRs)' means a specification of the characteristics of data (i.e. accuracy, resolution, integrity (or equivalent assurance level), traceability, timeliness, completeness and format) to ensure that the data is compatible with its intended use;
- (43) 'destination alternate' means an alternate aerodrome at which an aircraft would be able to land should it become either impossible or inadvisable to land at the aerodrome of intended landing;
- (44) 'duty' means any task that an air traffic controller is required to perform by the air traffic control service provider;
- (45) 'duty period' means a period which starts when an air traffic controller is required by the air traffic control service provider to report for or be available for or to commence duty and ends when the air traffic controller is free from duty;
- (46) 'elevation' means the vertical distance of a point or a level, on or affixed to the surface of the earth, measured from mean sea level;
- (47) 'en-route alternate' means an alternate aerodrome at which an aircraft would be able to land in the event that a diversion becomes necessary while en-route;

-
- (48) ‘fatigue’ means a physiological state of reduced mental or physical performance capability resulting from sleep loss or extended wakefulness, circadian phase or workload (mental or physical activity, or both) that can impair an individual's alertness and ability to safely perform his/her tasks;
- (49) ‘flight documentation’ means documents, including charts or forms, containing meteorological information for a flight;
- (50) ‘flight information centre (FIC)’ means a unit established to provide flight information service and alerting service;
- (51) ‘flight information region (FIR)’ means an airspace of defined dimensions within which flight information service and alerting service are provided;
- (52) ‘flight level (FL)’ means a surface of constant atmospheric pressure which is related to a specific pressure datum, 1013,2 hectopascals (hPa), and is separated from other such surfaces by specific pressure intervals;
- (53) ‘flight test’ means a flight for the development phase of a new design (aircraft, propulsion systems, parts and appliances), a flight to demonstrate compliance to certification basis or to type design for aircraft coming from the production line, a flight intended to experiment new design concepts, requiring unconventional manoeuvres or profiles for which it could be possible to exit the already approved envelope of the aircraft or a training flight to perform either of those flights;
- (54) ‘forecast’ means a statement of expected meteorological conditions for a specified time or period, and for a specified area or portion of airspace;
- (55) ‘forecast for take-off’ means a forecast for a specified period of time, prepared by an aerodrome meteorological office, which contains information on expected conditions over the runways complex in regard to surface wind direction and speed and any variations thereof, temperature, pressure (QNH) and any other element as agreed locally;
- (56) ‘functional system’ means a combination of procedures, human resources and equipment, including hardware and software, organised to perform a function within the context of ATM/ANS and other ATM network functions;
- (57) ‘general aviation’ means any civil aircraft operation other than aerial work or commercial air transport;
- (58) ‘grid point data in digital form’ means computer-processed meteorological data for a set of regularly spaced points on a chart, for transmission from a meteorological computer to another computer in a code form suitable for automated use;
- (59) ‘guidance material’ means non-binding material developed by the Agency that helps to illustrate the meaning of a requirement or specification and is used to support the interpretation of [Regulation \(EC\) No 216/2008](#), its implementing rules and AMC;
- (60) ‘gridded global forecasts’ means forecasts of expected values of meteorological elements on a global grid with a defined vertical and horizontal resolution;
- (61) ‘hazard’ means any condition, event, or circumstance which could induce a harmful effect;
- (62) ‘height’ means the vertical distance of a level, a point or an object considered as a point, measured from a specified datum;
- (63) ‘level’ is a generic term relating to the vertical position of an aircraft in flight and meaning variously height, altitude or flight level;

-
- (64) 'local routine report' means a meteorological report issued at fixed time intervals, intended only for dissemination at the aerodrome of origin where the observations were made;
- (65) 'local special report' means a meteorological report issued in accordance with the criteria established for special observations, intended only for dissemination at the aerodrome of origin where the observations were made;
- (66) 'meteorological bulletin' means a text comprising meteorological information preceded by an appropriate heading;
- (67) 'meteorological information' means meteorological report, analysis, forecast, and any other statement relating to existing or expected meteorological conditions;
- (68) 'meteorological observation' means the measurement and/or evaluation of one or more meteorological elements;
- (69) 'meteorological report' means a statement of observed meteorological conditions related to a specified time and location;
- (70) 'meteorological satellite' means an artificial Earth satellite making meteorological observations and transmitting these observations to Earth;
- (71) 'meteorological watch office (MWO)' means an office monitoring meteorological conditions affecting flight operations and providing information concerning the occurrence or expected occurrence of specified enroute weather and other phenomena in the atmosphere which may affect the safety of aircraft operations within its specified area of responsibility;
- (72) 'minimum sector altitude (MSA)' means the lowest altitude which may be used which will provide a minimum clearance of 300 m (1000 ft) above all objects located in an area contained within a sector of a circle of 46 km (25 NM) radius centred on a significant point, the aerodrome reference point (ARP) or the heliport reference point (HRP);
- (73) 'NOTAM' means a notice distributed by means of telecommunication containing information concerning the establishment, condition, or change in any aeronautical facility, service, procedure, or hazard, the timely knowledge of which is essential to personnel concerned with flight operations;
- (74) 'obstacle' means all fixed (whether temporary or permanent) and mobile objects, or parts thereof, that:
- (a) are located on an area intended for the surface movement of aircraft; or
 - (b) extend above a defined surface intended to protect aircraft in flight; or
 - (c) stand outside those defined surfaces and have been assessed as being a hazard to air navigation;
- (75) 'OPMET' means operational meteorological information for use in preparatory or in-flight planning of flight operations;
- (76) 'OPMET databank' means a databank established to store and make available internationally operational meteorological information for aeronautical use;
- (77) 'pre-eruption volcanic activity' means an unusual and/or increasing volcanic activity which could presage a volcanic eruption;
- (78) 'prevailing visibility' means the greatest visibility value, observed in accordance with the definition of 'visibility', which is reached within at least half the horizon circle or within at least half of the surface of the aerodrome. These areas could comprise contiguous or non-contiguous sectors;

-
- (79) 'problematic use of psychoactive substances' means the use of one or more psychoactive substances by an individual, in a way that:
- (a) constitutes a direct hazard to the user or endangers the lives, health, or welfare of others; and/or
 - (b) causes or worsens an occupational, social, mental or physical problem or disorder;
- (80) 'prognostic chart' means a forecast of (a) specified meteorological element(s) for a specified time or period and a specified surface or portion of airspace, depicted graphically on a chart;
- (81) 'psychoactive substances' means alcohol, opioids, cannabinoids, sedatives and hypnotics, cocaine, other psychostimulants, hallucinogens, and volatile solvents, whereas caffeine and tobacco are excluded;
- (82) 'rescue coordination centre (RCC)' means a unit responsible for promoting efficient organisation of search and rescue services, and for coordinating the conduct of search and rescue operations within a search and rescue region;
- (83) 'rest period' means a continuous and defined period of time, subsequent to and/or prior to duty, during which an air traffic controller is free of all duties;
- (84) 'rostering system' means the structure of duty and rest periods of air traffic controllers in accordance with legal and operational requirements;
- (85) 'risk' means the combination of the overall probability or frequency of occurrence of a harmful effect induced by a hazard and the severity of that effect;
- (86) 'runway' means a defined rectangular area on a land aerodrome prepared for the landing and take-off of aircraft;
- (87) 'runway visual range (RVR)' means the range over which the pilot of an aircraft on the centre line of a runway can see the runway surface markings or the lights delineating the runway or identifying its centre line;
- (88) 'safety directive' means a document issued or adopted by a competent authority which mandates actions to be performed on a functional system or sets restrictions to its operational use to restore safety when evidence shows that aviation safety may otherwise be compromised;
- (89) 'safety management system (SMS)' means a systematic approach to managing safety, including the necessary organisational structures, accountabilities, policies, and procedures;
- (90) 'search and rescue services unit' is a generic term covering, as the case may be, rescue coordination centre, rescue sub-centre or alerting post;
- (92) 'semi-automatic observing system' means an observing system that allows the augmentation of measured elements and requires a human in the loop for issuing the appropriate reports;
- (93) 'SIGMET' means information, issued by a meteorological watch office, concerning the occurrence or expected occurrence of specified en-route weather and other phenomena in the atmosphere which may affect the safety of aircraft operations and of the development of those phenomena in time and space;
- (95) 'special air-report' means a meteorological report by an aircraft issued in accordance with the criteria based on observations made during the flight;
- (96) 'stress' means the outcomes experienced by an individual when faced with a potential cause ('stressor') of human performance modification. The experience of the stressor may impact the individual's performance negatively (distress), neutrally or positively (eustress), based on the individual's perception of his/her ability to manage the stressor;
-

-
- (97) ‘system and equipment rating training’ means training designed to impart specific system/equipment knowledge and skills leading towards operational competence;
- (98) ‘tailored data’ means aeronautical data which is provided by the aircraft operator or DAT provider on the aircraft operator's behalf and produced for this aircraft operator for its intended operational use;
- (99) ‘take-off alternate aerodrome’ means an alternate aerodrome at which an aircraft would be able to land should this become necessary shortly after take-off and if it is not possible to use the aerodrome of departure;
- (100) ‘terminal aerodrome forecast (TAF)’ means a concise statement of the expected meteorological conditions at an aerodrome for a specified period;
- (101) ‘terrain’ means the surface of the Earth containing naturally occurring features such as mountains, hills, ridges, valleys, bodies of water, permanent ice and snow, and excluding obstacles;
- (102) ‘threshold’ means the beginning of that portion of the runway usable for landing;
- (103) ‘touchdown zone’ means the portion of a runway, beyond the threshold, where it is intended that landing aeroplanes first contact the runway;
- (104) ‘tropical cyclone’ is a generic term for a non-frontal synoptic-scale cyclone originating over tropical or subtropical waters with organised convection and definite cyclonic surface wind circulation;
- (105) ‘tropical cyclone advisory centre (TCAC)’ means a meteorological centre providing advisory information to meteorological watch offices, world area forecast centres and international OPMET databanks regarding the position, forecast direction and speed of movement, central pressure and maximum surface wind of tropical cyclones;
- (106) ‘visibility’ means visibility for aeronautical purposes, which is the greater of:
- (a) the greatest distance at which a black object of suitable dimensions, situated near the ground, can be seen and recognised when observed against a bright background;
 - (b) the greatest distance at which lights in the vicinity of 1000 candelas can be seen and identified against an unlit background;
- (107) ‘volcanic ash advisory centre (VAAC)’ means a meteorological centre that provides advisory information to meteorological watch offices, area control centres, flight information centres, world area forecast centres and international OPMET databanks regarding the lateral and vertical extent and forecast movement of volcanic ash in the atmosphere;
- (108) ‘world area forecast centre (WAFc)’ means a meteorological centre preparing and issuing significant weather (SIGWX) forecasts and upper-air forecasts in digital form on a global basis direct to the Member States as part of the aeronautical fixed service (AFS) internet-based services;
- (109) ‘world area forecast system (WAFS)’ means a worldwide system by which world area forecast centres provide aeronautical meteorological en-route forecasts in uniform standardised formats.
- (110) ‘aerodrome control tower’ means a unit established to provide air traffic control service to aerodrome traffic;

-
- (111) ‘aerodrome traffic’ means all traffic on the manoeuvring area of an aerodrome and all aircraft flying in the vicinity of an aerodrome. An aircraft operating in the vicinity of an aerodrome includes but is not limited to aircraft entering or leaving an aerodrome traffic circuit;
- (112) ‘aerodrome traffic circuit’ means the specified path to be flown by aircraft operating in the vicinity of an aerodrome;
- (113) ‘aeronautical fixed station’ means a station in the aeronautical fixed service;
- (114) ‘aeronautical ground light’ means any light specially provided as an aid to air navigation, other than a light displayed on an aircraft;
- (115) ‘aeronautical information circular (AIC)’ means a notice containing information that does not qualify for the origination of a NOTAM or for inclusion in the aeronautical information publication, but which relates to flight safety, air navigation, technical, administrative or legislative matters;
- (116) ‘aeronautical information management (AIM)’ means the dynamic, integrated management of aeronautical information through the provision and exchange of quality-assured digital aeronautical data in collaboration with all parties;
- (117) ‘aeronautical information product’ means aeronautical data and aeronautical information provided either as digital data sets or as a standardised presentation in paper or electronic media. Aeronautical information products include:
- aeronautical information publication, including amendments and supplements;
 - AIC;
 - aeronautical charts;
 - NOTAM;
 - digital data sets;
- (118) ‘aeronautical information publication (AIP)’ means a publication issued by or with the authority of a State and containing aeronautical information of a lasting character essential to air navigation;
- (119) ‘AIP amendment’ means a permanent change to the information contained in the AIP;
- (120) ‘AIP supplement’ means a temporary change to the information contained in the AIP, which is provided by means of special pages;
- (121) ‘aeronautical information regulation and control’ (AIRAC) means a system aimed at advance notification, based on common effective dates, of circumstances that necessitate significant changes in operating practices;
- (122) ‘aeronautical mobile service’ means a mobile service between aeronautical stations and aircraft stations, or between aircraft stations, in which survival craft stations may participate; emergency position-indicating radio beacon stations may also participate in this service on designated distress and emergency frequencies;
- (123) ‘aeronautical station’ means a land station in the aeronautical mobile service. In certain instances, an aeronautical station may be located, for example, on board a ship or on a platform at sea;
- (124) ‘aeronautical telecommunication station’ means a station in a telecommunication service provided for any aeronautical purpose;

-
- (125) 'AFIS aerodrome' means an aerodrome where AFIS is provided within the airspace associated with such aerodrome;
- (126) 'AFIS unit' means a unit established to provide AFIS and alerting service;
- (127) 'aircraft identification' means a group of letters, figures or a combination thereof which is either identical to, or the coded equivalent of, the aircraft call sign to be used in air-ground communications, and which is used to identify the aircraft in ground-ground air traffic service communications;
- (128) 'air-ground communication' means two-way communication between aircraft and stations or locations on the surface of the earth;
- (129) 'air traffic advisory service' means a service provided within an airspace of defined dimensions, or a designated route (advisory airspace) to ensure separation, in so far as practical, between aircraft which are operating on instrument flight rules (IFR) flight plans;
- (130) 'air traffic control clearance' or 'ATC clearance' means authorisation for an aircraft to proceed under conditions specified by an air traffic control unit;
- (131) 'air traffic control instruction' or 'ATC instruction' means directives issued by ATC for the purpose of requiring a pilot to take a specific action;
- (132) 'air traffic control (ATC) unit' or 'ATC unit' is a generic term meaning variously, area control centre, approach control unit or aerodrome control tower;
- (133) 'ALERFA' is the code word used to designate an alert phase;
- (134) 'alerting service' means a service provided to notify appropriate organisations regarding aircraft in need of search and rescue aid, and assist such organisations as required;
- (135) 'alert phase' means a situation wherein apprehension exists as to the safety of an aircraft and its occupants;
- (136) 'approach control unit' means a unit established to provide air traffic control service to controlled flights arriving at, or departing from, one or more aerodromes;
- (137) 'area navigation route' means an ATS route established for the use of aircraft capable of employing area navigation;
- (138) 'assemble' means a process of merging data from multiple sources into a database and establishing a baseline for subsequent processing;
- (139) 'ATS route' means a specified route designed for channelling the flow of traffic as necessary for the provision of ATS;
- (140) 'ATS surveillance service' means a service provided directly by means of an ATS surveillance system;
- (141) 'ATS surveillance system' means a generic term meaning variously, ADS-B, PSR, SSR or any comparable ground-based system that enables the identification of aircraft;
- (142) 'automatic dependent surveillance – broadcast (ADS-B)' means a means by which aircraft, aerodrome vehicles and other objects can automatically transmit or receive, or transmit and receive data such as identification, position and additional data, as appropriate, in a broadcast mode via a data link;
- (143) 'automatic dependent surveillance – contract (ADS-C)' means a means by which the terms of an ADS-C agreement will be exchanged between the ground system and the aircraft, via a data

- link, specifying under what conditions ADS-C reports would be initiated, and what data would be contained in the reports;
- (144) ‘automatic terminal information service (ATIS)’ means the automatic provision of current, routine information to arriving and departing aircraft throughout 24 hours a day or a specified portion thereof;
- (145) ‘data link-automatic terminal information service (D-ATIS)’ means the provision of ATIS via data link;
- (146) ‘voice-automatic terminal information service (Voice-ATIS)’ means the provision of ATIS by means of continuous and repetitive voice broadcasts;
- (147) ‘broadcast’ means a transmission of information relating to air navigation that is not addressed to a specific station or stations;
- (148) ‘ceiling’ means the height above the ground or water of the base of the lowest layer of cloud below 6 000 m (20 000 ft) covering more than half of the sky;
- (149) ‘clearance limit’ means the point to which an aircraft is granted an ATC clearance;
- (150) ‘cloud base’ means the height of the base of the lowest observed or forecast cloud element in the vicinity of an aerodrome or operating site or within a specified area of operations, normally measured above aerodrome elevation or, in the case of offshore operations, above mean sea level;
- (151) ‘completeness’ means, in relation to data, the degree of confidence that all data needed to support the intended use is provided;
- (152) ‘confidence level’ means the probability that the true value of a parameter is within a certain interval around the estimate of its value;
- (153) ‘conference communications’ means communication facilities whereby direct speech conversation may be conducted between three or more locations simultaneously;
- (154) ‘control zone’ means a controlled airspace extending upwards from the surface of the Earth to a specified upper limit;
- (155) ‘controlled aerodrome’ means an aerodrome at which air traffic control service is provided to aerodrome traffic;
- (156) ‘controlled airspace’ means an airspace of defined dimensions within which air traffic control service is provided in accordance with the airspace classification;
- (157) ‘controlled flight’ means any flight which is subject to an ATC clearance;
- (158) ‘controller-pilot data link communications (CPDLC)’ means a means of communication between air traffic controller and pilot, using data link for ATC communications;
- (159) ‘critical area’ means an area of defined dimensions extending around the ground equipment of a precision instrument approach within which the presence of vehicles or aircraft will cause unacceptable disturbance of the guidance signals;
- (160) ‘cruising level’ means a level maintained during a significant portion of a flight;
- (161) ‘cyclic redundancy check (CRC)’ means a mathematical algorithm applied to the digital expression of data that provides a level of assurance against loss or alteration of data;
- (162) ‘danger area’ means an airspace of defined dimensions within which activities dangerous to the flight of aircraft may exist at specified times;

-
- (163) 'data accuracy' means a degree of conformance between the estimated or measured value and the true value;
- (164) 'data collection surface' means a defined surface intended for the purpose of collecting obstacle or terrain data;
- (165) 'data integrity' means a degree of assurance that aeronautical data and its value has not been lost or altered since the data origination or authorised amendment;
- (166) 'data item' means a single attribute of a complete data set, which is allocated a value that defines its current status;
- (167) 'data link communications' means a form of communication intended for the exchange of messages via a data link;
- (168) 'data link-VOLMET (D-VOLMET)' means the provision of aerodrome routine meteorological report (METAR), aerodrome special meteorological report (SPECI), TAF, SIGMET, special air-reports not covered by a SIGMET and, where available, AIRMET via data link;
- (169) 'data origination' means the creation of a new data item with its associated value, the modification of the value of an existing data item or the deletion of an existing data item;
- (170) 'data product specification' means a detailed description of a data set or a collection of data sets together with additional information that will enable it to be created, supplied to and used by another party;
- (171) 'data set' means an identifiable collection of data;
- (172) 'datum' means any quantity or set of quantities that may serve as a reference or basis for the calculation of other quantities;
- (173) 'DETRESFA' is the code word used to designate a distress phase;
- (174) 'distress phase' means a situation wherein there is reasonable certainty that an aircraft and its occupants are threatened by grave and imminent danger or require immediate assistance;
- (175) 'downstream clearance' means a clearance issued to an aircraft by an air traffic control unit that is not the current controlling authority of that aircraft;
- (176) 'essential traffic' means controlled traffic to which the provision of separation by air traffic control service is applicable, but which, in relation to a particular controlled flight is not, or will not be, separated from other controlled traffic by the appropriate separation minimum;
- (177) 'essential local traffic' means any aircraft, vehicle or personnel on or near the manoeuvring area, or traffic in the take-off and climb-out area or the final approach area, which may constitute a hazard to the aircraft concerned;
- (178) 'estimated time of arrival' means:
- (a) for IFR flights, the time at which it is estimated that the aircraft will arrive over a designated point, defined by reference to navigation aids, from which it is intended that an instrument approach procedure will be commenced, or, if no navigation aid is associated with the aerodrome, the time at which the aircraft will arrive over the aerodrome;
 - (b) for visual flight rules (VFR) flights, the time at which it is estimated that the aircraft will arrive over the aerodrome;
- (179) 'feature' means an abstraction of real world phenomena;

-
- (180) 'feature attribute' means a characteristic of a feature that has a name, a data type and a value domain associated with it;
- (181) 'feature type' means a class of real world phenomena with common properties, which forms the basic level of classification in a feature catalogue;
- (182) 'final approach' means that part of an instrument approach procedure which:
- (a) commences at the specified fix or point, or, where such a fix or point is not specified, at either of the following places:
 - (i) at the end of the last procedure turn, base turn or inbound turn of a racetrack procedure, if specified;
 - (ii) at the point of interception of the last track specified in the approach procedure,
 - (b) ends at a point in the vicinity of an aerodrome from which a landing can be made or a missed approach procedure is initiated;
- (183) 'flight information zone' means an airspace of defined dimension within which aerodrome flight information service and alerting service for aerodrome traffic are provided;
- (184) 'flight procedure design services' means services for the design, documentation, validation, maintenance and periodic review of flight procedures necessary for the safety, regularity and efficiency of air navigation;
- (185) 'flight procedure designer' means a qualified person who performs design, documentation, validation, continuous maintenance, and periodic review of flight procedures;
- (186) 'flight procedure' means a set of predetermined flight manoeuvres intended to be followed by a pilot, published by electronic, printed or digital means, or both. Flight procedure is conducted either in accordance with instrument flight rules (IFR) or visual flight rules (VFR);
- (187) 'flight plan' means specified information provided to air traffic services units, relative to an intended flight or portion of a flight of an aircraft;
- (188) 'flight visibility' means the visibility forward from the cockpit of an aircraft in flight;
- (189) 'format' means, in relation to data, a structure of data items, records and files arranged to meet standards, specifications or data quality requirements;
- (190) 'geoid' means the equipotential surface in the gravity field of the Earth which coincides with the undisturbed mean sea level (MSL) extended continuously through the continents;
- (191) 'geoid undulation' means the distance of the geoid above (positive) or below (negative) the mathematical reference ellipsoid;
- (192) 'glide path' means a descent profile determined for vertical guidance during a final approach;
- (193) 'ground visibility' means the visibility at an aerodrome, as reported by an accredited observer or by automatic systems;
- (194) 'heading' means the direction in which the longitudinal axis of an aircraft is pointed, usually expressed in degrees from North (true, magnetic, compass or grid);
- (195) 'heliport' means an aerodrome or a defined area on a structure intended to be used wholly or in part for the arrival, departure and surface movement of helicopters;
- (196) 'integrity classification' means, in relation to aeronautical data, a classification based upon the potential risk resulting from the use of corrupted data, defining routine, essential and critical data;

- (197) ‘international NOTAM office (NOF)’ means an office designated by a Member State for the exchange of NOTAM internationally;
- (198) ‘holding fix’ means a geographical location that serves as a reference for a holding procedure;
- (199) ‘holding procedure’ means a predetermined manoeuvre which keeps an aircraft within a specified airspace while awaiting further clearance;
- (200) ‘identification’ means the situation which exists when the position indication of a particular aircraft is seen on a situation display and positively identified;
- (201) ‘instrument flight rules’ are rules which allow an aircraft which is equipped with suitable navigation equipment appropriate to the route to be flown in accordance with the applicable requirements on air operations.
- (202) ‘INCERFA’ is the code word used to designate an uncertainty phase;
- (203) ‘instrument approach operations’ means an approach and landing using instruments for navigation guidance based on an instrument approach procedure. There are two methods for executing instrument approach operations:
- (a) a two-dimensional (2D) instrument approach operation, using lateral navigation guidance only;
 - (b) a three-dimensional (3D) instrument approach operation, using both lateral and vertical navigation guidance;
- (204) ‘instrument approach procedure (IAP)’ means a series of predetermined manoeuvres by reference to flight instruments with specified protection from obstacles from the initial approach fix, or where applicable, from the beginning of a defined arrival route to a point from which a landing can be completed and thereafter, if a landing is not completed, to a position at which holding or en-route obstacle clearance criteria apply. Instrument approach procedures are classified as follows:
- (a) ‘non-precision approach (NPA) procedure’ means an instrument approach procedure designed for 2D instrument approach operations Type A.
 - (b) ‘approach procedure with vertical guidance (APV)’ means a performance-based navigation (PBN) instrument approach procedure designed for 3D instrument approach operations Type A.
 - (c) ‘precision approach (PA) procedure’ means an instrument approach procedure based on navigation systems (ILS, MLS, GLS and SBAS Cat I) designed for 3D instrument approach operations Type A or B;]
- (205) ‘instrument meteorological conditions (IMC)’ means meteorological conditions expressed in terms of visibility, distance from cloud, and ceiling, less than the minima specified for visual meteorological conditions;
- (206) ‘low-visibility operations (LVOs)’ means approach or take-off operations on a runway with a runway visual range (RVR) of less than 550 m or with a decision height (DH) of less than 200 ft;
- (206a) ‘low-visibility procedures’ means procedures applied at an aerodrome for the purpose of ensuring safety during low-visibility operations;
- (207) ‘manoeuvring area’ means that part of an aerodrome to be used for the take-off, landing and taxiing of aircraft, excluding aprons;
- (208) ‘metadata’ means data about data;

-
- (209) ‘movement area’ means that part of an aerodrome to be used for the take-off, landing and taxiing of aircraft, consisting of the manoeuvring area and the apron;
- (210) ‘navigation aid’ means a facility or system external to the aircraft, which generates electromagnetic signals to be used by aircraft navigation systems for position determination or flight path guidance;
- (211) ‘mode Secondary Surveillance Radar (SSR)’ means the conventional identifier related to specific functions of the interrogation signals transmitted by an SSR interrogator. There are four modes specified in ICAO Annex 10: A, C, S and intermode;
- (212) ‘near-parallel runways’ means non-intersecting runways whose extended centre lines have an angle of convergence/divergence of 15 degrees or less;
- (212a) ‘operation with operational credits’ means an operation using specific aircraft or ground equipment, or a combination of aircraft and ground equipment which allows any of the following elements:
- (a) the application of lower-than-standard aerodrome operating minima for a particular classification of operation;
 - (b) visibility requirements can be satisfied or reduced;
 - (c) fewer ground facilities are required;
- (213) ‘pilot-in-command’ means the pilot designated by the operator, or in the case of General Aviation, the owner, as being in command and charged with the safe conduct of a flight;
- (214) ‘position’ means, in a geographical context, a set of coordinates (latitude and longitude) referenced to the mathematical reference ellipsoid, which define the position of a point on the surface of the Earth;
- (215) ‘position indication’ means the visual indication, in non-symbolic or symbolic form, or both, on a situation display, of the position of an aircraft, aerodrome vehicle or other object;
- (216) ‘pressure-altitude’ means an atmospheric pressure expressed in terms of altitude which corresponds to that pressure in the Standard Atmosphere;
- (217) ‘primary radar’ means a radar system which uses reflected radio signals;
- (218) ‘printed communications’ means communications which automatically provide a permanent printed record at each terminal of a circuit of all messages which pass over such circuit;
- (219) ‘prohibited area’ means an airspace of defined dimensions, above the land areas or territorial waters of a Member State, within which the flight of aircraft is prohibited;
- (220) ‘radio navigation service’ means a service providing guidance information or position data for the efficient and safe operation of aircraft supported by one or more radio navigation aids;
- (221) ‘radiotelephony’ means a form of radio communication primarily intended for the exchange of information in the form of speech;
- (222) ‘required communication performance specification’ or ‘RCP specification’ means a set of requirements for air traffic service provision and associated ground equipment, aircraft capability, and operations needed to support performance-based communication;
- (223) ‘required surveillance performance specification’ or ‘RSP specification’ means a set of requirements for air traffic service provision and associated ground equipment, aircraft capability, and operations needed to support performance-based surveillance;

-
- (224) ‘resolution’ means, in relation to data, a number of units or digits to which a measured or calculated value is expressed and used;
- (225) ‘restricted area’ means an airspace of defined dimensions, above the land areas or territorial waters of a Member State, within which the flight of aircraft is restricted in accordance with certain specified conditions;
- (226) ‘route stage’ means a route or portion of a route flown without an intermediate landing;
- (227) ‘runway-in-use’ means the runway or runways that, at a particular time, are considered by the air traffic services unit to be the most suitable for use by the types of aircraft expected to land or take off at the aerodrome. Separate or multiple runways may be designated runway-in-use for arriving aircraft and departing aircraft;
- (228) ‘secondary radar’ means a radar system wherein a radio signal transmitted from the radar station initiates the transmission of a radio signal from another station;
- (229) ‘secondary surveillance radar (SSR)’ means a surveillance radar system which uses transmitters and receivers (interrogators) and transponders;
- (230) ‘sensitive area’ means an area extending beyond the critical area where the parking or movement of aircraft or vehicles will affect the guidance signal to the extent that it may be rendered as an unacceptable disturbance to aircraft using the signal;
- (231) ‘SNOWTAM’ means a special series NOTAM given in a standard format, which provides a surface condition report notifying the presence or cessation of hazardous conditions due to snow, ice, slush, frost, standing water or water associated with snow, slush, ice, or frost on the movement area;
- (232) ‘significant point’ means a specified geographical location used in defining an ATS route or the flight path of an aircraft and for other navigation and air traffic services purposes;
- (233) ‘situation display’ means an electronic display depicting the position and movement of aircraft and other information as required;
- (234) ‘standard instrument arrival (STAR)’ means a designated IFR arrival route that links a significant point, normally on an ATS route, with a point from which a published instrument approach procedure can be commenced;
- (235) ‘standard instrument departure (SID)’ means a designated IFR departure route that links the aerodrome or a specified runway of the aerodrome with a specified significant point, normally on a designated ATS route, at which the en-route phase of a flight commences;
- (236) ‘special VFR flight’ means a VFR flight cleared by ATC to operate within a control zone in meteorological conditions below VMC;
- (237) ‘taxiing’ means movement of an aircraft on the surface of an aerodrome or an operating site under its own power, excluding take-off and landing;
- (238) ‘taxiway’ means a defined path on a land aerodrome established for the taxiing of aircraft and intended to provide a link between one part of the aerodrome and another;
- (239) ‘terminal control area (TMA)’ means a control area normally established at the confluence of ATS routes in the vicinity of one or more major aerodromes;
- (240) ‘timeliness’ means, in relation to data, the degree of confidence that the data is applicable to the period of its intended use;

-
- (241) 'traceability' means, in relation to data, the degree to which a system or a data product can provide a record of the changes made to that product and thereby enable an audit trail to be followed from the end-user to the party originating data;
- (242) 'track' means the projection on the Earth's surface of the path of an aircraft, the direction of which path at any point is usually expressed in degrees from North (true, magnetic or grid);
- (243) 'traffic information' means information issued by an air traffic services unit to alert a pilot to other known or observed air traffic which may be in proximity to the position or intended route of flight and to help the pilot avoid a collision;
- (244) 'transfer of control point' means a defined point located along the flight path of an aircraft, at which the responsibility for providing air traffic control service to the aircraft is transferred from one control unit or control position to the next;
- (245) 'transferring unit' means air traffic control unit in the process of transferring the responsibility for providing air traffic control service to an aircraft to the next air traffic control unit or air traffic controller along the route of flight;
- (246) 'transition altitude' means the altitude at or below which the vertical position of an aircraft is controlled by reference to altitudes;
- (247) 'transition layer' means the airspace between the transition altitude and the transition level;
- (248) 'transition level' means the lowest flight level available for use above the transition altitude;
- (249) 'validation' means, in relation to data, the process of ensuring that data meets the requirements for the specified application or intended use;
- (250) 'verification' means, in relation to data, the evaluation of the output of an aeronautical data process to ensure correctness and consistency with respect to the inputs and applicable data standards, rules and conventions used in that process;
- (251) 'uncertainty phase' means a situation wherein uncertainty exists as to the safety of an aircraft and its occupants;
- (252) 'unmanned free balloon' means a non-power-driven, unmanned, lighter-than-air aircraft in free flight;
- (253) 'vectoring' means the provision of navigational guidance to aircraft in the form of specific headings, based on the use of an ATS surveillance system;
- (254) 'visual flight rules flight' or 'VFR flight' means a flight conducted in accordance with the visual flight rules;
- (255) 'visual approach' means an approach by an IFR flight when either part or all of an instrument approach procedure is not completed and the approach is executed in visual reference to terrain;
- (256) 'visual meteorological conditions (VMC)' means meteorological conditions expressed in terms of visibility, distance from cloud, and ceiling, equal to or better than specified minima;
- (257) 'VOLMET' means meteorological information for aircraft in flight;
- (258) 'VOLMET broadcast' means the provision, as appropriate, of current METAR, SPECI, TAF and SIGMET by means of continuous and repetitive voice broadcasts;
- (259) 'waypoint' means a specified geographical location used to define an area navigation route or the flight path of an aircraft employing area navigation. Waypoints are identified as either:

- (a) fly-by waypoint – a waypoint which requires turn anticipation to allow tangential interception of the next segment of a route or procedure, or
 - (b) fly-over waypoint – a waypoint at which a turn is initiated in order to join the next segment of a route or procedure
- (260) “U-space airspace” means a UAS geographical zone designated by Member States, where UAS operations are only allowed to take place with the support of U-space services;
- (261) “U-space service” means a service relying on digital services and automation of functions designed to support safe, secure and efficient access to U-space airspace for a large number of UAS;
- (262) “common information service” means a service consisting in dissemination of static and dynamic data to enable the provision of U-space services for the management of traffic of unmanned aircraft;
- (263) “dynamic airspace reconfiguration” means the temporary modification of the U-space airspace in order to accommodate short-term changes in manned traffic demand, by adjusting the geographical limits of that U-space airspace.
- (264) ‘volcano observatory’ means a provider, selected by the competent authority, which observes the activity of a volcano or a group of volcanoes and makes these observations available to an agreed list of aviation recipients;
- (265) ‘Geography Markup Language (GML)’ means an encoding standard of the Open Geospatial Consortium (OGC);
- (266) ‘space weather centre (SWXC)’ means a centre designated to monitor and provide advisory information on space weather phenomena expected to affect high-frequency radio communications, communications via satellite, GNSS-based navigation and surveillance systems and/or pose a radiation risk to aircraft occupants.

GM1 2. Aerial work

ED Decision 2020/008/R

GENERAL

Regulation (EU) 2017/373 and Regulation (EU) No 923/2012 define ‘aerial work’ in a way that is similar but not identical to the way Regulation (EU) No 965/2012 (the ‘Air Operations Regulation’) defines ‘specialised operations’. Both definitions, ‘aerial work’ and ‘specialised operations’, are based upon the ICAO Annex 6 definitions and encompass a variety of activities that do not fall into the category of commercial air transport (CAT) operations.

In this context, it is understood that:

- (a) Unlike ‘aerial work’, ‘specialised operations’ do not include flights conducted for the purposes of search and rescue and firefighting as from the Air Operations Regulation’s perspective those flights are outside the scope of the European Union Aviation Safety Agency (EASA) Basic Regulation.
- (b) Unlike ‘aerial work’, ‘specialised operations’ include (test) flights carried out by design or production organisations for the purpose of introduction or modification of aircraft types and (ferry) flights carrying no passengers or cargo where the aircraft is ferried for refurbishment, repair, maintenance checks, inspections, delivery, export or similar purposes.

GM1 9. Aeronautical data

ED Decision 2017/001/R

DAT PROVIDERS

Aeronautical data in the context of DAT providers should mean that aeronautical data needed for the functionality of certified aircraft application(s) and does not form part of its (their) approved type design. It may change over the course of time such as e.g. ‘aerodrome mapping data’, ‘obstacles data’ and ‘terrain data’, etc. which are amongst other types of ‘aeronautical data’.

GM1 20. Air traffic safety electronics personnel (ATSEP)

ED Decision 2017/001/R

AUTHORISED PERSONNEL

- (a) The achievement of competence is independent of the permission to perform any task. Therefore, the ATSEP should be authorised to work on operational systems.
- (b) It is intentionally not specified who is responsible for providing this authorisation. This is usually done by the service provider, but it might be done by another entity depending on the national arrangements for managing the competence and performance of ATSEP.

OPERATE, MAINTAIN, RELEASE FROM, AND RETURN INTO OPERATIONS

- (c) The term ‘operate’ refers to the ability of the ATSEP to actively control a system and should not be confused with, for example, the air traffic controllers’ function to operate particular equipment in order to provide air traffic services. However, it is necessary for ATSEP to have an understanding of how air traffic controllers operate or make use of operational systems, in order to repair and maintain them appropriately. An ATSEP usually manages the engineering operation of operational systems, for example by:
 - (1) making a radiotelephony test transmission to check a voice communication and control system or a recording system;
 - (2) switching between systems A and B, or switching off the stand-by system, in case of duplicated systems; or
 - (3) changing the range and gating maps of a radar system processor.
- (d) The term ‘maintain’ refers to planned, preventative and corrective maintenance, including fault-finding.
- (e) The term ‘release from operations’ refers to the process of withdrawal from use of a system/equipment from the operational environment, and ‘return into operations’ refers to the process whereby the system/equipment is checked and restored to operational use, in accordance with both risk assessment and mitigation.

MAINTENANCE TASKS BY ATSEP

- (f) An operational system that has been released from operational service, but remains connected to the operational environment must be maintained by ATSEP.
- (g) An operational system that has been removed and fully isolated from the operational environment by ATSEP, and cannot be returned without ATSEP intervention, may be maintained by a non-ATSEP, but will be subject to the ANSP’s checks before return to the operational environment.
- (h) A non-ATSEP is not authorised to remove an operational system from the operational environment.

- (i) A non-ATSEP is not authorised to return a system into the operational environment.
- (j) An ATSEP is responsible for determining the operational system status/serviceability before returning it to the operational environment.

GM2 20. Air traffic safety electronics personnel (ATSEP)

ED Decision 2017/001/R

SCOPE

The design, testing, installation and commissioning of operational systems and equipment are excluded from the scope of this section.

DESIGN OF OPERATIONAL SYSTEMS AND EQUIPMENT

Design also includes software.

COMMISSIONING OF OPERATIONAL SYSTEMS AND EQUIPMENT

The term ‘commissioning’ is understood to be the process by which a system/equipment, which has been installed, is tested to ensure that it works according to its design objectives or specifications, and that it is ready to be operated and maintained in accordance with the users’ operational requirements.

GM1 32. Authoritative source

ED Decision 2017/001/R

ORGANISATIONS

Organisations formally recognised by the State authority to originate and/or publish data, which meets the Data Quality Requirements (DQRs) as specified by that State, may be considered at least but are not limited to Mapping, Cadastre, and Land Registry authorities.

GM1 42. Data quality requirements (DQRs)

ED Decision 2017/001/R

GENERAL

Depending on the data characteristics considered, DQRs are specified as ‘internationally recognised Data Quality Requirements’ (mainly when data is provided by authoritative sources), ‘end-user Data Quality Requirements’ (typically for completeness, timeliness, etc.), or ‘system designer Data Quality Requirements’ (considering other data characteristics, such as accuracy, resolution, assurance level, traceability, format, etc.).

GM1 56. Functional system

ED Decision 2019/022/R

SOFTWARE

The term ‘software’ is understood to be the computer programmes and corresponding configuration data, including non-developmental software, but excluding electronic items, namely application specific integrated circuits, programmable gate arrays or solid-state logic controllers.

In this text:

- (a) the term ‘configuration data’ is understood to be the data that configures a generic software system to a particular instance of its use; and

- (b) the term ‘non-developmental software’ is understood as a software not developed for the current contract.

GM1 74. Obstacle

ED Decision 2017/001/R

MOBILE OBJECTS

Mobile objects may be converted to fixed items in obstacle database taking into account its mobility boundaries.

GM1 101. Terrain

ED Decision 2017/001/R

GENERAL

In practical terms, depending on the method of data collection used, terrain represents the continuous surface that exists at the bare Earth, the top of the canopy or something in-between, also known as ‘first reflective surface’.

GM1 130. Air traffic control clearance or ATC clearance

ED Decision 2020/008/R

GENERAL

Throughout the text, the term ‘air traffic control clearance’ is frequently abbreviated to ‘clearance’ when used in appropriate contexts.

In this context, the abbreviated term ‘clearance’ may be prefixed by the words ‘taxi’, ‘take-off’, ‘departure’, ‘en-route’, ‘approach’ or ‘landing’ to indicate the particular portion of flight to which the ATC clearance relates.

GM1 138. Assemble

ED Decision 2020/008/R

AERONAUTICAL DATA

The assemble phase includes checking the data and ensuring that detected errors and omissions are rectified.

GM1 139. ATS route

ED Decision 2020/008/R

TYPES OF ATS ROUTES

- (a) The term ‘ATS route’ is used to mean variously ‘airway’, ‘advisory route’, ‘controlled route’, ‘uncontrolled route’ (i.e. VFR routes or corridors), ‘arrival or departure route’, etc.
- (b) An ATS route is defined by route specifications, which include an ATS route designator, the track to or from significant points (waypoints), distance between significant points, reporting requirements and the minimum flight altitude.

GM1 141. ATS surveillance system

ED Decision 2020/008/R

GENERAL

A comparable ground-based system is one that has been demonstrated, by comparative assessment or other methodology, to have a level of safety and performance equal to or better than monopulse SSR.

GM1 143. Automatic dependent surveillance — contract (ADS-C)

ED Decision 2020/008/R

GENERAL

The abbreviated term ‘ADS contract’ is commonly used to refer to ‘ADS event contract’, ‘ADS demand contract’, ‘ADS periodic contract’ or an emergency mode.

GM1 152. Confidence level

ED Decision 2020/008/R

AERONAUTICAL DATA

The interval is usually referred to as the accuracy of the estimate.

GM1 155. Controlled aerodrome

ED Decision 2020/008/R

GENERAL

The airspace associated with a controlled aerodrome is designed in compliance with the requirements in Annex XI (Part-FPD).

GM1 156. Controlled airspace

ED Decision 2020/008/R

AIRSPACE CLASSIFICATION

Details of the airspace classifications could be found in Section 6 ‘Airspace classification’ and SERA.6001 ‘Classification of airspaces’ of Commission Implementing Regulation (EU) No 923/2012, in Appendix 4 ‘ATS airspace classes — services provided and flight requirements’ to the same Regulation, and in the associated Acceptable Means of Compliance and Guidance Material.

GM1 170. Data product specification

ED Decision 2020/008/R

AERONAUTICAL DATA

A data product specification provides a description of the universe of discourse and a specification for mapping the universe of discourse to a data set. It may be used for production, sales, end use or other purpose. Data product specification provides a means by which the content of a data set is precisely specified. A data product specification supports the party generating a data set by providing information as to what exactly should be included within the data set. The content of the data product specification is closely related to the metadata. The users of the data may determine, by comparing their data product specification with the metadata, how the data may be used in their application and what mitigations, if any, are needed as result of, for example, the quality/completeness of the data.

GM1 196. Integrity classification

ED Decision 2020/008/R

AERONAUTICAL DATA

Aeronautical data is classified as:

- (a) routine data: there is a very low probability when using corrupted routine data that the continued safe flight and landing of an aircraft would be severely at risk with the potential for a catastrophe;
- (b) essential data: there is a low probability when using corrupted essential data that the continued safe flight and landing of an aircraft would be severely at risk with the potential for a catastrophe; and
- (c) critical data: there is a high probability when using corrupted critical data that the continued safe flight and landing of an aircraft would be severely at risk with the potential for a catastrophe.

GM1 203. Instrument approach operations

ED Decision 2020/008/R

NAVIGATION GUIDANCE

Lateral and vertical navigation guidance refers to the guidance provided either by:

- (a) ground-based radio navigation aid; or
- (b) computer-generated navigation data from ground-based, space-based, self-contained navigation aids or a combination of them.

GM1 208. Metadata

ED Decision 2020/008/R

GENERAL

A structured description of the content, quality, condition or other characteristics of data.

GM1 232. Significant point

ED Decision 2020/008/R

GENERAL

There are three categories of significant points: ground-based navigation aid, intersection and waypoint. In the context of this definition, intersection is a significant point expressed as radials, bearings and/or distances from ground-based navigation aids.

GM1 (262) 'SPACE WEATHER CENTRE (SWXC)'

ED Decision 2022/004/R

GENERAL

A space weather centre (SWXC) is designated as global and/or regional.

ANNEX II — PART-ATM/ANS.AR

REQUIREMENTS FOR COMPETENT AUTHORITIES — OVERSIGHT OF SERVICES AND OTHER ATM NETWORK FUNCTIONS

SUBPART A — GENERAL REQUIREMENTS

ATM/ANS.AR.A.001 Scope

Regulation (EU) 2017/373

This Annex establishes the requirements for the administration and management systems of the competent authorities responsible for certification, oversight and enforcement in respect of the application of the requirements set out in Annexes III to XIII by the service providers in accordance with [Article 6](#).

ATM/ANS.AR.A.005 Certification, oversight and enforcement tasks

Regulation (EU) 2017/373

- (a) The competent authority shall exercise certification, oversight and enforcement tasks in respect of the application of the requirements applicable to service providers, monitor the safe provision of their services and verify that the applicable requirements are met.
- (b) The competent authorities shall identify and exercise the responsibilities for certification, oversight and enforcement in a manner which ensures that:
 - (1) specific points of responsibility exist to implement each provision of this Regulation;
 - (2) they are aware of the safety oversight mechanisms and their results;
 - (3) relevant information exchange is ensured between competent authorities.

The competent authorities concerned shall regularly review the agreement on the supervision of the service providers providing air navigation services in functional airspace blocks (FABs) that extend across the airspace falling under the responsibility of more than one Member States referred to in Article 2(3) of [Regulation \(EC\) No 550/2004](#) and, in the case of cross-border provision of air navigation services, the agreement on the mutual recognition of supervisory tasks referred to in Article 2(5) of [Regulation \(EC\) No 550/2004](#), as well as the practical implementation of those agreements, in particular in the light of achieved safety performance of the service providers under their supervision.

- (c) The competent authority shall establish coordination arrangements with other competent authorities for notified changes to functional systems involving service providers under the oversight of the other competent authorities. Those coordination arrangements shall ensure the effective selection and review of those notified changes, in accordance with point [ATM/ANS.AR.C.025](#).

AMC1 ATM/ANS.AR.A.005(b) Certification, oversight and enforcement tasks

ED Decision 2017/001/R

REVIEW OF THE AGREEMENT

The agreement on the supervision in a functional airspace block (FAB) or in cases of cross-border provision should include the frequency of the review.

GM1 ATM/ANS.AR.A.005(b) Certification, oversight and enforcement tasks

ED Decision 2017/001/R

CONCLUSION OF AN AGREEMENT

The agreement on the supervision in a FAB or in cases of cross-border provision may be concluded among:

- (a) the competent authorities nominated or established under agreements concluded among Member States in accordance with Article 2(3) of [Regulation \(EC\) No 550/2004](#); or
- (b) the competent authorities of the service providers in cases of cross-border provision.

GM2 ATM/ANS.AR.A.005(b) Certification, oversight and enforcement tasks

ED Decision 2017/001/R

REVIEW OF THE AGREEMENT

During the review of the agreement, the competent authorities should address the practical implementation considering the results of the assessment performed in accordance with [ATM/ANS.AR.C.001](#).

GM1 ATM/ANS.AR.A.005(c) Certification, oversight and enforcement tasks

ED Decision 2017/001/R

COORDINATION ARRANGEMENTS BETWEEN COMPETENT AUTHORITIES FOR SELECTION AND REVIEW OF MULTI-ACTOR CHANGES

- (a) When the notification of a change to a service provider's functional system indicates, as per [AMC1 ATM/ANS.OR.A.045\(a\)](#), that the change will affect the services provided by other service providers either directly or by affecting the context in which these services are delivered, these other service providers and the notifying service provider are participating in a multi-actor change. Some or all of these other service providers may also notify their competent authorities because they either have to make a reactive change or they are participating in a cooperative change to their functional systems.
- (b) If there are service providers participating in the multi-actor change who are proposing to make changes to their functional systems and are under the oversight of more than one competent authority, then the decision to review and the review itself of safety assessments and safety support assessments has to be a coordinated activity involving all the competent authorities that oversee the service providers participating in the multi-actor change.

- (c) Normally, competent authorities act independently when making decisions on how to select and review safety assessments, but in the case of multi-actor changes that cross State boundaries, the only way to ensure the effective selection and review of the notified changes is through coordination with other competent authorities. Coordination arrangements, which are difficult to define in advance, are to be established when the need arises. The objective of these agreements should be to ensure that the overall change is safe, i.e. the overall safety case is based on a complete and correct set of assumptions and mitigations and the associated risk assessments are valid.
- (d) The arrangements should ensure that:
- (1) the competent authorities involved evaluate in a harmonised way the risk posed by the change, and as a consequence there is an agreement on what safety (support) assessments will be reviewed by each competent authority; and
 - (2) individual reviews of safety (support) assessments assure the necessary conditions are met, i.e. common assumptions and common mitigations are used correctly in each safety (support) assessment and the identified risks are valid.
- (e) However, the assurance that the set of common assumptions and common mitigations are complete and correct cannot be provided in each individual safety case. The argument for that assurance has to be made in an overall safety case and reviewed collectively by the competent authorities involved in the overall change. The form of this collective review should be included in the coordination agreement.

ATM/ANS.AR.A.010 Certification, oversight and enforcement documentation

Regulation (EU) 2017/373

The competent authority shall make available the relevant legislative acts, standards, rules, technical publications and related documents to its personnel in order to perform their tasks and to discharge their responsibilities.

ATM/ANS.AR.A.015 Means of compliance

Regulation (EU) 2017/373

- (a) The Agency shall develop acceptable means of compliance (AMC) that may be used to establish compliance with the requirements of this Regulation. When AMC are complied with, the applicable requirements of this Regulation shall be deemed to have been met.
- (b) Alternative means of compliance (AltMOC) may be used to establish compliance with the requirements of this Regulation.
- (c) The competent authority shall establish a system to consistently evaluate that all AltMOC used by itself or by the service providers under its oversight allow the establishment of compliance with the requirements of this Regulation.
- (d) The competent authority shall evaluate all AltMOC proposed by a service provider in accordance with point [ATM/ANS.OR.A.020](#) by analysing the documentation provided and, if considered necessary, conducting an inspection of the service provider.

When the competent authority finds that the AltMOC are sufficient to ensure compliance with the applicable requirements of this Regulation it shall without undue delay:

- (1) notify the applicant that the AltMOC may be implemented and, if applicable, amend the certificate of the applicant accordingly;
 - (2) notify the Agency of their content, including copies of all relevant documentation;
 - (3) inform other Member States about the AltMOC that were accepted.
- (e) When the competent authority itself uses AltMOC to achieve compliance with the applicable requirements of this Regulation, it shall:
- (1) make them available to all service providers under its oversight;
 - (2) notify the Agency without undue delay.

The competent authority shall provide the Agency with a full description of the AltMOC, including any revisions to procedures that may be relevant, as well as an assessment demonstrating that the applicable requirements of this Regulation are met.

GM1 ATM/ANS.AR.A.015 Means of compliance

ED Decision 2017/001/R

GENERAL

Alternative means of compliance used by a competent authority or by organisations under its oversight may be used by other competent authorities or service providers only if processed again in accordance with [ATM/ANS.AR.A.015\(d\) and \(e\)](#).

AMC1 ATM/ANS.AR.A.015(d)(3) Means of compliance

ED Decision 2017/001/R

GENERAL

The information to be provided to other Member States following approval of an alternative means of compliance (AltMoC) should contain a reference to the acceptable means of compliance (AMC) to which such means of compliance provides an alternative, where such AMC exists, as well as a reference to the corresponding implementing rule (IR), indicating, as applicable, the point(s) covered by the AltMoC.

ATM/ANS.AR.A.020 Information to the Agency

Regulation (EU) 2021/1338

- (a) The competent authority shall notify the Agency in case of any significant problems with the implementation of Regulation (EU) 2018/1139 and its delegated and implementing acts within 30 days from the time the competent authority has become aware of the problems.
- (b) Without prejudice to Regulation (EU) No 376/2014 of the European Parliament and of the Council (*) and its delegated and implementing acts, the competent authority shall provide the Agency with safety-significant information stemming from the occurrence reports stored in its national database in accordance with Article 6(6) of Regulation (EU) No 376/2014, as soon as possible.

(*) Regulation (EU) No 376/2014 of the European Parliament and of the Council of 3 April 2014 on the reporting, analysis and follow-up of occurrences in civil aviation, amending Regulation (EU) No 996/2010 of the European Parliament and of the Council and repealing Directive 2003/42/EC of the European Parliament and of the Council and Commission Regulations (EC) No 1321/2007 and (EC) No 1330/2007 (OJ L 122, 24.4.2014, p. 18).

AMC1 ATM/ANS.AR.A.020(b) Information to the Agency

ED Decision 2022/004/R

PROVISION OF SAFETY-SIGNIFICANT INFORMATION TO THE AGENCY

Each competent authority should appoint a coordinator to act as the point of contact for the provision of safety-significant information to the Agency.

GM1 ATM/ANS.AR.A.020(b) Information to the Agency

ED Decision 2022/004/R

MEANING OF SAFETY-SIGNIFICANT INFORMATION STEMMING FROM OCCURRENCE REPORTS

Safety-significant information stemming from occurrence reports means a conclusive safety analysis that summarises individual occurrence data and provides an in-depth analysis of a safety issue, which may be relevant for the Agency's safety action planning.

GM2 ATM/ANS.AR.A.020(b) Information to the Agency

ED Decision 2022/004/R

SAFETY-SIGNIFICANT INFORMATION STEMMING FROM THE OCCURRENCE REPORTS

The conclusive safety analysis based on the occurrence reports should contain the following:

- (a) a detailed description of the safety issue, including the scenario in which the safety issue takes place; and
- (b) an indication of the stakeholders affected by the safety issue, including types of operations and organisations;
and, as appropriate:
- (c) a risk assessment establishing the severity and probability of all the possible consequences of the safety issue;
- (d) information about the existing safety barriers that the aviation system has in place to prevent the likely safety issue consequences from occurring;
- (e) any mitigating actions already in place or developed to address the safety issue;
- (f) recommendations for future actions to control the risk; and
- (g) any other element(s) the competent authority considers essential for the Agency to properly assess the safety issue.

GM3 ATM/ANS.AR.A.020(b) Information to the Agency

ED Decision 2017/001/R

REPORTING CRITERIA FOR SAFETY-SIGNIFICANT INFORMATION STEMMING FROM OCCURRENCE REPORTS WHERE THE AGENCY IS THE COMPETENT AUTHORITY

In the case of occurrences related to organisations certified by the Agency, safety-significant information stemming from occurrence reports should be notified to the Agency if:

- (a) the occurrence is defined as a reportable occurrence for organisations certified as Pan-European service providers and service providers in the airspace of the territory to which the Treaty applies and having their principal place of operation or, if any, their registered office located outside the territory subject to the provisions of the Treaty; and

- (b) the competent authority has come to the conclusion that:
- (1) the organisation certified by the Agency to which the occurrence relates, has not been informed of the occurrence; or
 - (2) the occurrence has not been properly addressed or has been left unattended by the organisation certified by the Agency.

Such occurrence data should be reported in a format compatible with the European Coordination Centre for Accident and Incident Reporting Systems (ECCAIRS) and should provide all relevant information for its assessment and analysis, including necessary additional files in the form of attachments.

ATM/ANS.AR.A.025 Immediate reaction to safety problem

Regulation (EU) 2017/373

- (a) Without prejudice to Regulation (EU) No 376/2014, the competent authority shall implement a system to appropriately collect, analyse, and disseminate safety information.
- (b) The Agency shall implement a system to appropriately analyse any relevant safety information received from the competent authorities and without undue delay provide to Member States and the Commission, as appropriate, any information, including recommendations or corrective actions to be taken, necessary for them to react in a timely manner to a safety problem involving the service providers.
- (c) Upon receiving the information referred to in points (a) and (b), the competent authority shall take adequate measures to address the safety problem, including the issuing of safety directives in accordance with point [ATM/ANS.AR.A.030](#).
- (d) Measures taken under point (c) shall immediately be notified to the service providers concerned to comply with them, in accordance with point [ATM/ANS.OR.A.060](#). The competent authority shall also notify those measures to the Agency and, when combined action is required, the other competent authorities concerned.

ATM/ANS.AR.A.030 Safety directives

Regulation (EU) 2017/373

- (a) The competent authority shall issue a safety directive when it has determined the existence of an unsafe condition in a functional system requiring immediate action.
- (b) The safety directive shall be forwarded to the service providers concerned and contain, as a minimum, the following information:
 - (1) the identification of the unsafe condition;
 - (2) the identification of the affected functional system;
 - (3) the actions required and their rationale;
 - (4) the time limit for completing the actions required;
 - (5) its date of entry into force.
- (c) The competent authority shall forward a copy of the safety directive to the Agency and any other competent authorities concerned within one month from its issuance.
- (d) The competent authority shall verify the compliance of service providers with the applicable safety directives.

GM1 ATM/ANS.AR.A.030 Safety directives

ED Decision 2017/001/R

GENERAL

- (a) The safety directive is a document issued by the competent authority, mandating actions to be performed by one or more service providers, when evidence shows that aviation safety may otherwise be compromised. Thus, the competent authority is responsible for the determination of the actions required and their rationale.
- (b) The competent authority is required to perform a verification of compliance of the service providers with the safety directives in accordance with [ATM/ANS.AR.A.030\(d\)](#). In this respect, [ATM/ANS.AR.C.005\(a\)\(6\)](#) requires the competent authority to establish a process to verify the implementation of safety directives by the service providers. The actions that need to be taken depend on the content of the safety directive and the nature of the unsafe condition.

GM2 ATM/ANS.AR.A.030(b) Safety directives

ED Decision 2017/001/R

CONTENT

[Name of the competent authority]	SAFETY DIRECTIVE
[Logo of the competent authority]	SD No/ ISSUE No:[...] Date: dd Month YYYY
This Safety Directive is issued in accordance with Commission Implementing Regulation (EU) 2017/373	
[Name of the service provider(s)]	[Identification of the affected functional system]
Safety Directive Title	[Title]
Unsafe condition identified:	[Describe the unsafe condition that is the reason for the issuance of the SD]
Required action(s), their rationale and compliance time(s):	[Describe the required action(s) and their rationale; indicate the compliance time(s) within which the action(s) should be accomplished]
Date of entry into force of SD:	dd Month YYYY
Distributed to:	(a) [service provider(s) address: Post code, City Country Email address:...]

	(b) [competent authorities concerned] (c) [European Aviation Safety Agency]
Remarks:	

GM3 ATM/ANS.AR.A.030(c) Safety directives

ED Decision 2017/001/R

FORWARDING OF SAFETY DIRECTIVES

For instance, a safety directive that should be forwarded to the Agency under [ATM/ANS.AR.A.030](#) could be a case:

- (a) where the competent authority has determined that there is an immediate need to take certain actions in order to respond to a safety recommendation; or
- (b) following an accident or serious incident; or
- (c) when this or a similar unsafe condition may be present in other service providers of the same Member State.

SUBPART B — MANAGEMENT (ATM/ANS.AR.B)

ATM/ANS.AR.B.001 Management system

Regulation (EU) 2021/1338 (EU) 2021/1338

- (a) The competent authority shall establish and maintain a management system, including, as a minimum, the following elements:
- (1) documented policies and procedures to describe its organisation, means and methods to achieve compliance with Regulation (EU) 2018/1139 and the delegated and implementing acts adopted on the basis thereof, as necessary, for the exercise of its certification, oversight and enforcement tasks. The procedures shall be kept up to date and serve as the basic working documents within that competent authority for all related tasks;
 - (2) a sufficient number of personnel, including inspectors, to perform its tasks and discharge its responsibilities under this Regulation. Such personnel shall be qualified to perform their allocated tasks and have the necessary knowledge, experience, initial, on-the-job and recurrent training to ensure continuing competence. A system shall be in place to plan the availability of personnel, in order to ensure the proper completion of all related tasks;
 - (3) adequate facilities and office accommodation to perform those allocated tasks;
 - (4) a process to monitor compliance of the management system with the relevant requirements and adequacy of the procedures, including the establishment of an internal audit process and a safety risk management process. Compliance monitoring shall include a feedback system of audit findings to the senior management of the competent authority to ensure implementation of corrective actions as necessary;
 - (5) a person or group of persons ultimately responsible to the senior management of the competent authority for the compliance monitoring function.
- (b) The competent authority shall, for each field of activity included in the management system, appoint one or more persons with the overall responsibility for the management of the relevant task(s).
- (c) The competent authority shall establish procedures for the participation in a mutual exchange of all necessary information and assistance with other competent authorities concerned, whether from within the Member State or in other Member States, including the following information:
- (1) the relevant findings raised and follow-up actions taken as a result of oversight of ATM/ANS providers exercising activities in the territory of a Member State, but certified by the competent authority of another Member State or the Agency; and
 - (2) stemming from mandatory and voluntary occurrence reporting as required by point [ATM/ANS.OR.A.065](#).
- (d) A copy of the procedures related to the management system and their amendments shall be made available to the Agency for the purpose of standardisation.

AMC1 ATM/ANS.AR.B.001(a)(2) Management system

ED Decision 2017/001/R

QUALIFIED PERSONNEL

The competent authority should:

- (a) define and document the education, training, technical and operational knowledge, experience and qualifications relevant to the duties of each position involved in oversight activities within their structure;
- (b) ensure specific training for those involved in oversight activities within their structure; and
- (c) ensure that personnel designated to conduct safety regulatory audits, including auditing personnel from qualified entities, meet specific qualification criteria defined by the competent authority. The criteria should address:
 - (1) the knowledge and understanding of the requirements related to the services provision in ATM/ANS and other ATM network functions against which safety regulatory audits may be performed;
 - (2) the use of assessment techniques;
 - (3) the skills required for managing an audit; and
 - (4) the demonstration of competence of auditors through evaluation or other acceptable means.

AMC2 ATM/ANS.AR.B.001(a)(2) Management system

ED Decision 2017/001/R

TRAINING PROGRAMME AND RECURRENT TRAINING

- (a) The competent authority should establish a training programme for its personnel, including its inspectors for the oversight of services provision in ATM/ANS and other ATM network functions, and a plan for its implementation. The training programme should include, as appropriate to the role, current knowledge, experience and skills of the personnel, at least the following:
 - (1) organisation and structure of the aviation legislation;
 - (2) the Chicago Convention, relevant ICAO annexes and documents, the applicable requirements of [Regulation \(EC\) No 216/2008](#)¹, its IRs, as well as Regulations (EC) Nos 549/2004², 550/2004³, 551/2004⁴, and 552/2004⁵ and their IRs and related

¹ Regulation (EC) No 216/2008 of the European Parliament and the Council of 20 February 2008 on common rules in the field of civil aviation and establishing a European Aviation Safety Agency, and repealing Council Directive 91/670/EEC, Regulation (EC) No 1592/2002 and Directive 2004/36/EC (OJ L 79, 19.3.2008, p. 1).

² Regulation (EC) No 549/2004 of the European Parliament and of the Council of 10 March 2004 laying down the framework for the creation of the single European sky (the framework Regulation) - Statement by the Member States on military issues related to the single European sky (OJ L 96, 31.3.2004, p. 1).

³ Regulation (EC) No 550/2004 of the European Parliament and of the Council of 10 March 2004 on the provision of air navigation services in the single European sky (the service provision Regulation) (OJ L 96, 31.3.2004, p. 10).

⁴ Regulation (EC) No 551/2004 of the European Parliament and of the Council of 10 March 2004 on the organisation and use of the airspace in the single European sky (the airspace Regulation) - Commission statement (OJ L 96, 31.3.2004, p. 20).

⁵ Regulation (EC) No 552/2004 of the European Parliament and of the Council of 10 March 2004 on the interoperability of the European Air Traffic Management network (the interoperability Regulation) (OJ L 96, 31.3.2004, p. 26).

- acceptable means of compliance (AMC), certification specifications (CSs) and guidance material (GM), as well as assessment methodology of the alternative means of compliance and the applicable national legislation;
- (3) the applicable requirements and procedures; and
 - (4) areas of particular interest.
- (b) The training programme and the training plan should be updated, as needed, to reflect at least changes in aviation legislation and industry. The training programme should also cover specific needs of the personnel and the competent authority.
- (c) The competent authority should ensure that its personnel, including its inspectors for the oversight of services provision in ATM/ANS and other ATM network functions, undergo recurrent training at regular intervals as defined by the competent authority or whenever deemed necessary in order to keep being up to date.

GM1 ATM/ANS.AR.B.001(a)(2) Management system

ED Decision 2017/001/R

SUFFICIENT PERSONNEL

- (a) This guidance material for the determination of the required personnel is limited to the performance of certification and oversight tasks, excluding personnel required to perform tasks subject to any national regulatory requirements.
- (b) The elements to be considered when determining required personnel and planning their availability may be divided into quantitative and qualitative:
- (1) Quantitative elements:
 - (i) number of initial certificates to be issued;
 - (ii) number of service providers certified by the competent authority; and
 - (iii) number of flight information services providers having declared their activity to the competent authority.
 - (2) Qualitative elements:
 - (i) size, nature, and complexity of activities of service providers (cf. [AMC1 ATM/ANS.OR.B.005\(e\)](#));
 - (ii) results of past oversight activities, including audits, inspections and reviews, in terms of risks and regulatory compliance:
 - (A) number and level of findings; and
 - (B) implementation of corrective actions; and
 - (iii) size of the Member State's aviation industry and potential growth of activities in the field of civil aviation, which may be an indication of the number of new applications and changes to existing certificates to be expected.
- (c) Based on existing data from previous oversight planning cycles and taking into account the situation within the Member State's aviation industry, the competent authority may estimate:
- (1) the standard working time required for processing applications for new certificates;
 - (2) the standard working time required for processing declarations;

- (3) the number of new declarations or changed declarations;
 - (4) the number of new certificates to be issued for each planning period; and
 - (5) the number of changes to existing certificates and changes to functional systems to be processed for each planning period.
- (d) In line with the competent authority's oversight policy, the following planning data should be determined specifically for each service provider, certified or declared, as well as for the Network Manager:
- (1) standard number of audits/inspections to be performed per oversight planning cycle;
 - (2) standard duration of each audit/inspection;
 - (3) standard working time for audit/inspection preparation, on-site audit/inspection, reporting and follow-up per inspector for the oversight of services provision and other ATM network functions; and
 - (4) minimum number and required qualification of inspectors for the oversight of services provision and other ATM network functions for each audit/inspection.
- (e) Standard working time could be expressed either in working hours or in working days per inspector for the oversight of services provision and other ATM network functions. All planning calculations should then be based on the same unit (hours or working days).
- (f) For each service provider, the number of working hours/days per planning period for each qualified inspector for the oversight of services provision and other ATM network functions that may be allocated for certification, oversight and enforcement activities should be determined taking into account:
- (1) purely administrative tasks not directly related to oversight and certification;
 - (2) training;
 - (3) participation in other projects;
 - (4) planned absence; and
 - (5) the need to include a reserve for unplanned tasks or unforeseeable events.
- (g) The determination of working time available for certification, oversight and enforcement activities should also take into account the possible use of third parties.

AMC1 ATM/ANS.AR.B.001(a)(4) Management system

ED Decision 2017/001/R

COMPLIANCE MONITORING PROCESS

The formal process to monitor the compliance of the management system with the relevant requirements, and the adequacy of the procedures should:

- (a) include a feedback system of audit findings to ensure implementation of corrective actions as necessary; and
- (b) be the responsibility of a person or group of persons who should be responsible to the senior management of the competent authority and who perform(s) compliance monitoring activities with functional independence from the units/departments (s)he (they) oversees (oversee) and with direct access to the senior management of the competent authority and to appropriate management for safety matters.

ATM/ANS.AR.B.005 Allocation of tasks to qualified entities

Regulation (EU) 2017/373

- (a) The competent authority may allocate its tasks related to the certification or oversight of service providers under this Regulation, other than the issuance of certificates themselves, to qualified entities. When allocating such tasks, the competent authority shall ensure that it has:
- (1) a system in place to initially and continuously assess that the qualified entity complies with Annex V to [Regulation \(EC\) No 216/2008](#). This system and the results of the assessments shall be documented; and
 - (2) established a documented agreement with the qualified entity, approved by both parties at the appropriate management level, which clearly defines:
 - (i) the tasks to be performed;
 - (ii) the declarations, reports and records to be provided;
 - (iii) the technical conditions to be met when performing such tasks;
 - (iv) the related liability coverage;
 - (v) the protection given to information acquired when carrying out such tasks.
- (b) The competent authority shall ensure that the internal audit process and the safety risk management process required by point [ATM/ANS.AR.B.001\(a\)\(4\)](#) cover all tasks performed on its behalf by the qualified entity.

AMC1 ATM/ANS.AR.B.005 Allocation of tasks to qualified entities

ED Decision 2017/001/R

ASSESSMENT OF THE QUALIFIED ENTITIES

- (a) The competent authority should include in its system to initially and continuously assess the qualified entity's (ies') compliance with Annex V to [Regulation \(EC\) No 216/2008](#), the possibility for the competent authority to perform audits of the qualified entity (ies).
- (b) The competent authority should verify that all qualified entities' personnel concerned with the conduct of audits or reviews should be adequately trained and qualified. The competent authority should verify how the qualified entities:
- (1) define and document the education, training, technical and operational knowledge, experience and qualifications for those involved in oversight activities;
 - (2) ensure specific training for those involved in oversight activities; and
 - (3) ensure that personnel designated to conduct audits meet specific qualification criteria. The criteria should address:
 - (i) the knowledge and understanding of the requirements related to the services provision in ATM/ANS and other ATM network functions against which audits may be performed;
 - (ii) the use of assessment techniques;
 - (iii) the skills required for managing an audit; and
 - (iv) the demonstration of competence of auditors through evaluation or other acceptable means.

GM1 ATM/ANS.AR.B.005 Allocation of tasks to qualified entities

ED Decision 2019/022/R

GENERAL

The competent authority may decide to allocate to qualified entities certain or all of its tasks that are assigned to such authority under this Regulation.

ATM/ANS.AR.B.010 Changes in the management system

Regulation (EU) 2021/1338

- (a) The competent authority shall have a system in place to identify changes that affect its capability to perform its tasks and discharge its responsibilities under Regulation (EU) 2018/1139 and the delegated and implementing acts adopted on the basis thereof. This system shall enable it to take action, as appropriate, to ensure that the management system remains adequate and effective.
- (b) The competent authority shall update its management system to reflect any changes to Regulation (EU) 2018/1139 and the delegated and implementing acts adopted on the basis thereof, in a timely manner, so as to ensure the effective implementation of its management system.
- (c) The competent authority shall notify the Agency of changes affecting its capability to perform its tasks and discharge its responsibilities under Regulation (EU) 2018/1139 and the delegated and implementing acts adopted on the basis thereof.

ATM/ANS.AR.B.015 Record-keeping

Regulation (EU) 2017/373

- (a) The competent authority shall establish a system of record-keeping providing for adequate storage, accessibility, and reliable traceability of:
 - (1) the management system's documented policies and procedures;
 - (2) training, qualification, and authorisation of personnel as required by point [ATM/ANS.AR.B.001\(a\)\(2\)](#);
 - (3) the allocation of tasks, covering the elements required by point [ATM/ANS.AR.B.005](#), as well as the details of tasks allocated;
 - (4) certification and/or declaration processes;
 - (5) designations of air traffic services and meteorological services providers, as appropriate;
 - (6) certification and oversight of service providers exercising activities within the territory of the Member State, but certified by the competent authority of another Member State or the Agency, as agreed between those authorities;
 - (7) the evaluation and notification to the Agency of AltMOC proposed by service providers and the assessment of AltMOC used by the competent authority itself;
 - (8) compliance of service providers with the applicable requirements of this Regulation after the issuance of the certificate or, where relevant, submission of a declaration, including the reports of all audits, covering findings, corrective actions, and date of action closure, and observations as well as other safety-related records;
 - (9) enforcement measures taken;

- (10) safety information, safety directives and follow-up measures;
 - (11) the use of flexibility provisions in accordance with Article 14 of [Regulation \(EC\) No 216/2008](#).
- (b) The competent authority shall maintain a list of all service provider certificates issued and declarations received.
- (c) All records shall be kept for a minimum period of 5 years after the certificate ceases to be valid or the declaration is withdrawn, subject to the applicable data protection law.

AMC1 ATM/ANS.AR.B.015(a)(2) Record-keeping

ED Decision 2017/001/R

DURATION OF RETENTION PERIOD OF RECORDS

Records related to the training and qualification of the personnel of the competent authority should be kept until the end of their employment.

AMC1 ATM/ANS.AR.B.015(a)(8) Record-keeping

ED Decision 2017/001/R

RECORD-KEEPING FOR FUNCTIONAL SYSTEMS CHANGE MANAGEMENT PROCEDURES

The competent authority should keep a record of all the change management procedures, modifications and deviations it has approved in accordance with [ATM/ANS.AR.C.030\(a\)](#) and those that have been rejected, together with a rationale. The competent authority should be able to cross-reference them to the requirement of the associated requirement in the Regulation that they intend to comply with.

SUBPART C — OVERSIGHT, CERTIFICATION AND ENFORCEMENT (ATM/ANS.AR.C)

ATM/ANS.AR.C.001 Monitoring of safety performance

Regulation (EU) 2017/373

- (a) The competent authorities shall regularly monitor and assess the safety performance of the service providers under their oversight.
- (b) The competent authorities shall use the results of the monitoring of safety performance in particular within their risk-based oversight.

ATM/ANS.AR.C.005 Certification, declaration, and verification of service providers' compliance with the requirements

Regulation (EU) 2017/373

- (a) Within the framework of point [ATM/ANS.AR.B.001\(a\)\(1\)](#), the competent authority shall establish a process in order to verify:
 - (1) service providers' compliance with the applicable requirements set out in Annexes III to XIII, and any applicable conditions attached to the certificate before the issue of that certificate. The certificate shall be issued in accordance with Appendix 1 to this Annex;
 - (2) compliance with any safety-related obligations in the designation act issued in accordance with Article 8 of [Regulation \(EC\) No 550/2004](#);
 - (3) continued compliance with the applicable requirements of the service providers under its oversight;
 - (4) implementation of safety objectives, safety requirements and other safety-related conditions identified in declarations of verification of systems, including any relevant declaration of conformity or suitability for use of constituents of systems issued in accordance with [Regulation \(EC\) No 552/2004](#);
 - (5) the implementation of safety directives, corrective actions and enforcement measures.
- (b) The process referred to in point (a) shall:
 - (1) be based on documented procedures;
 - (2) be supported by documentation specifically intended to provide its personnel with guidance to perform their tasks related to certification, oversight and enforcement;
 - (3) provide the organisation concerned with an indication of the results of the certification, oversight and enforcement activity;
 - (4) be based on audits, reviews and inspections conducted by the competent authority;
 - (5) with regard to certified service providers, provide the competent authority with the evidence needed to support further action, including measures referred to in Article 9 of [Regulation \(EC\) No 549/2004](#), Article 7(7) of Regulation (EC) No 550/2004, and by Articles 10, 25, and 68 of [Regulation \(EC\) No 216/2008](#) in situations where requirements are not complied with;

- (6) with regard to service providers making declarations, provide the competent authority with the evidence to take, if appropriate, remedial action which may include enforcement actions, including, where appropriate, under national law.

ATM/ANS.AR.C.010 Oversight

Regulation (EU) 2017/373

- (a) The competent authority, or qualified entities acting on its behalf, shall conduct audits, in accordance with [Article 5](#).
- (b) The audits referred to in point (a) shall:
- (1) provide the competent authority with evidence of compliance with the applicable requirements and with the implementing arrangements;
 - (2) be independent of any internal auditing activities undertaken by the service provider;
 - (3) cover complete implementing arrangements or elements thereof, and processes or services;
 - (4) determine whether:
 - (i) the implementing arrangements comply with the applicable requirements;
 - (ii) the actions taken comply with the implementing arrangements and the applicable requirements;
 - (iii) the results of actions taken match the results expected from the implementing arrangements.
- (c) The competent authority shall, on the basis of the evidence at its disposal, monitor the continuous compliance with the applicable requirements of this Regulation of the service providers under its oversight.

GM1 ATM/ANS.AR.C.010 Oversight

ED Decision 2017/001/R

DEMONSTRATION OF COMPLIANCE — DAT PROVIDERS

In addition to the applicable requirements, the competent authority should assess the standards and processes applied by the DAT provider. The following specific areas should be overseen against EUROCAE ED-76A/RTCA DO-200B ‘Standards for Processing Aeronautical Data’, dated June 2015:

- (a) plans and procedures, including:
- (1) alteration procedures (i.e. informing the supplier or data originator of the data alteration and endeavouring to receive concurrence/agreement);
 - (2) data verification and validation (including the procedures that define the level of checking of the database prior to release). These procedures should be reviewed to ensure adequacy;
 - (3) reporting and handling procedures (including occurrence reporting);
 - (4) data configuration management;
 - (5) data transmission practices;
 - (6) tool qualification; and

- (7) internal audit checks and response mechanisms;
- (b) internal standards; and
- (c) definition of 'Data Quality Requirements'.

EUROCAE ED-76/RTCA DO-200A may be also used for the demonstration of compliance.

AMC1 ATM/ANS.AR.C.010(a) Oversight

ED Decision 2017/001/R

AUDITS

The audits should include oversight of changes to the functional system in order to:

- (a) verify that changes made to the functional system:
 - (1) comply with [ATM/ANS.OR.A.045](#);
 - (2) have been managed in accordance with the procedures identified in [ATM/ANS.OR.B.010\(a\)](#) that have been approved; and
 - (3) are being verified against the monitoring criteria that were identified in the assurance argument as a result of complying with [ATM/ANS.OR.C.005\(b\)\(2\)](#) or [ATS.OR.205\(b\)\(6\)](#), as appropriate; and
- (b) verify that if, as a result of the monitoring referred to in (a)(3), the argument, referred to in [ATS.OR.205\(a\)\(2\)](#) and [ATM/ANS.OR.C.005\(a\)\(2\)](#), is found to be incomplete and/or incorrect, then the service provider has initiated a change or has revised the argument such that the inferences or evidence are now sufficient to justify the claim.

GM1 ATM/ANS.AR.C.010(b)(1) Oversight

ED Decision 2017/001/R

IMPLEMENTING ARRANGEMENTS

Implementing arrangements should be considered to be the service provider's (safety) management system(s) documentation, manuals, service provision conditions or the certificate and the content of the declaration, as applicable.

ATM/ANS.AR.C.015 Oversight programme

Regulation (EU) 2017/373

- (a) The competent authority shall establish and update annually an oversight programme taking into account the specific nature of the service providers, the complexity of their activities, the results of past certification and/or oversight activities and shall be based on the assessment of associated risks. It shall include audits, which shall:
 - (1) cover all the areas of potential safety concern, with a focus on those areas where problems have been identified;
 - (2) cover all the service providers under the supervision of the competent authority;
 - (3) cover the means implemented by the service provider to ensure the competency of personnel;
 - (4) ensure that audits are conducted in a manner commensurate with the level of the risk posed by the service provider operations and services provided; and

- (5) ensure that for service providers under its supervision, an oversight planning cycle not exceeding 24 months is applied.

The oversight planning cycle may be reduced if there is evidence that the safety performance of the service provider has decreased.

For a service provider certified by the competent authority, the oversight planning cycle may be extended to a maximum of 36 months if the competent authority has established that, during the previous 24 months:

- (i) the service provider has demonstrated an effective identification of aviation safety hazards and management of associated risks;
- (ii) the service provider has continuously demonstrated compliance with the change management requirements under points [ATM/ANS.OR.A.040](#) and [ATM/ANS.OR.A.045](#);
- (iii) no level 1 findings have been issued;
- (iv) all corrective actions have been implemented within the time period accepted or extended by the competent authority as defined in point [ATM/ANS.AR.C.050](#).

If, in addition to the above, the service provider has established an effective continuous reporting system to the competent authority on the safety performance and regulatory compliance of the service provider, which has been approved by the competent authority, the oversight planning cycle may be extended to a maximum of 48 months;

- (6) ensure follow-up of the implementation of corrective actions;
 - (7) be subject to consultation with the service providers concerned and notification thereafter;
 - (8) indicate the envisaged interval of the inspections of the different sites, if any.
- (b) The competent authority may decide to modify the objectives and the scope of pre-planned audits, including documentary reviews and additional audits, wherever that need arises.
 - (c) The competent authority shall decide which arrangements, elements, services, functions, physical locations, and activities are to be audited within a specified time frame.
 - (d) Audit observations and findings issued in accordance with point [ATM/ANS.AR.C.050](#) shall be documented. The latter shall be supported by evidence, and identified in terms of the applicable requirements and their implementing arrangements against which the audit has been conducted.
 - (e) An audit report, including the details of the findings and observations, shall be drawn up and communicated to the service provider concerned.

AMC1 ATM/ANS.AR.C.015 Oversight programme

ED Decision 2017/001/R

GENERAL

- (a) When establishing an oversight programme appropriate to each provider, the competent authority should take into account the safety performance of the service provider to be audited. Inspectors for the oversight of services provision and other ATM network functions should work in accordance with the schedule provided to them.

- (b) Having regard to the performance of service providers, the competent authority may vary the frequency of the audits or inspections.
- (c) When defining the oversight programme, the competent authority should assess the risks related to the activity of each service provider, certified or declared, or the Network Manager, and adapt the audits and inspections to the level of risk identified.

AMC1 ATM/ANS.AR.C.015(a) Oversight programme

ED Decision 2017/001/R

SPECIFIC NATURE AND COMPLEXITY OF THE ORGANISATION

- (a) When determining the oversight programme for a service provider, the competent authority should consider in particular the following elements, as applicable:
 - (1) the implementation by the service provider of industry standards, directly relevant to the organisation's activity subject to this Regulation;
 - (2) the procedure applied for and scope of changes not requiring prior approval in accordance with [ATM/ANS.OR.A.040\(b\)](#); and
 - (3) specific procedures implemented by the service provider related to any alternative means of compliance used.
- (b) For the purpose of assessing the complexity of an organisation's management system, [AMC1 ATM/ANS.OR.B.005\(e\)](#) should be used.

AMC1 ATM/ANS.AR.C.015(a)(1) Oversight programme

ED Decision 2017/001/R

AREA OF POTENTIAL SAFETY CONCERNS — DAT PROVIDERS

The competent authority should audit the DAT provider's procedures for dealing with situations where resolution and corrections could not be obtained with the aeronautical data source or other DAT providers for data that has been called into question in accordance with [AMC1 DAT.TR.105\(a\)](#). Such audits should confirm that effective controls are in place to ensure that an unsafe product is not released and that such concerns are communicated to customers in accordance with the requirements laid down in [DAT.OR.200](#).

ATM/ANS.AR.C.020 Issue of certificates

Regulation (EU) 2017/373

- (a) Following the process laid down in point [ATM/ANS.AR.C.005\(a\)](#), upon receiving an application for the issuance of a certificate to a service provider, the competent authority shall verify the service provider's compliance with the applicable requirements of this Regulation.
- (b) The competent authority may require any audits, inspections or assessments it finds necessary before issuing the certificate.
- (c) The certificate shall be issued for an unlimited duration. The privileges of the activities that the service provider is approved to conduct shall be specified in the service provision conditions attached to the certificate.
- (d) The certificate shall not be issued where a level 1 finding remains open. In exceptional circumstances, finding(s), other than level 1, shall be assessed and mitigated as necessary by

the service provider and a corrective action plan for closing the finding(s) shall be approved by the competent authority prior to the certificate being issued.

GM1 ATM/ANS.AR.C.020(c) Issue of certificates

ED Decision 2020/008/R

OPERATIONAL CONDITIONS OR LIMITATIONS

- (a) If, during the certification process, an operational condition or limitation has been determined as necessary to be imposed on or implemented by the service provider, the competent authority should ensure that such operational condition or limitation is prescribed in the service provision conditions attached to the service provider's certificate.
- (b) Limitations in the certification may be used to identify restrictions to be applied in the provision of services and any other particularity of the service provided (e.g. intended usage, type of operations).
- (c) Limitations may also relate to some restrictions on the service(s) provided associated with non-compliances with respect to some performance requirements.
- (d) Conditions may address actions that require to be accomplished to confirm the validity of the certificate.

GM2 ATM/ANS.AR.C.020(c) Issue of certificates

ED Decision 2020/008/R

EXAMPLES OF LIMITATIONS IN SERVICES

- (a) Limitations for the provision of ILS Signal in Space could be:
 - (1) CAT I;
 - (2) CAT II; and
 - (3) CAT III.
- (b) Limitations for the provision of Global Navigation Satellite System (GNSS) signal could be:
 - (1) based on the system used to provide Signal-in-Space:
 - (i) GNSS Core System;
 - (ii) Satellite-Based Augmentation System (SBAS); and
 - (iii) Ground-Based Augmentation System (GBAS); and/or
 - (2) based on the type of operations supported (e.g. en-route, en-route terminal, NPA, APV-I, APV-II, Cat I, from ICAO Annex 10)
- (c) Limitations for the Aeronautical Mobile Service (air-ground communication) could be:
 - (1) for flight information services;
 - (2) for area control service;
 - (3) for approach control service; and
 - (4) for aerodrome control service.
- (d) Limitations for the provision of data from the secondary surveillance radar (SSR) could be:
 - (1) mode A/C; and

- (2) mode S.
- (e) Limitations for the provision of data from automatic dependant surveillance (ADS) could be:
 - (1) ADS-C; and
 - (2) ADS-B.
- (f) Limitations for the provision of flight procedure design services could be:
 - (1) conventional navigation AIDs procedure design;
 - (2) performance-based navigation (PBN) procedure design; and
 - (3) design procedure for helicopters.

GM3 ATM/ANS.AR.C.020(c) Issue of certificates

ED Decision 2020/008/R

EXAMPLES OF CONDITIONS ATTACHED TO THE CERTIFICATE

Conditions attached to certificates may, as appropriate, be related to:

- (a) non-discriminatory access to services for airspace users and the required level of performance of such services, including safety and interoperability levels;
- (b) the time by which the services should be provided;
- (c) ring-fencing or restriction of operations of services other than those related to the provision of services;
- (d) contracts, agreements or other arrangements between the service provider and a third party and which concern the service(s);
- (e) provision of information reasonably required for the verification of the continuous compliance with the requirements;
- (f) any other legal conditions which are not specific to the services.

For further reference, please consult Annex II to Regulation (EC) No 550/2004.

ATM/ANS.AR.C.025 Changes

Regulation (EU) 2017/373

- (a) Upon receiving a notification for a change in accordance with point [ATM/ANS.OR.A.045](#), the competent authority shall comply with points [ATM/ANS.AR.C.030](#), [ATM/ANS.AR.C.035](#) and [ATM/ANS.AR.C.040](#).
- (b) Upon receiving a notification for a change in accordance with point [ATM/ANS.OR.A.040\(a\)\(2\)](#) that requires prior approval, the competent authority shall:
 - (1) verify the service provider's compliance with the applicable requirements before issuing the change approval;
 - (2) take immediate appropriate action, without prejudice to any additional enforcement measures, when the service provider implements changes requiring prior approval without having received competent authority approval referred to in point (1).

- (c) To enable a service provider to implement changes to its management system and/or safety management system, as applicable, without prior approval in accordance with point [ATM/ANS.OR.A.040\(b\)](#), the competent authority shall approve a procedure defining the scope of such changes and describing how such changes will be notified and managed. In the continuous oversight process, the competent authority shall assess the information provided in the notification to verify whether the actions taken comply with the approved procedures and applicable requirements. In case of any non-compliance, the competent authority shall:
- (1) notify the service provider of the non-compliance and request further changes;
 - (2) in case of level 1 and level 2 findings, act in accordance with point [ATM/ANS.AR.C.050](#).

AMC1 ATM/ANS.AR.C.025(b) Changes

ED Decision 2017/001/R

CHANGES REQUIRING PRIOR APPROVAL

- (a) Upon receipt of a notification for a proposed change that requires prior approval, the competent authority should:
- (1) formally acknowledge the receipt of the notification in writing within 10 working days;
 - (2) assess the proposed change in relation to the service provider's certificate or the conditions attached or management system of it, and the applicable requirements of [Part-ATM/ANS.OR](#), as well as any other applicable requirements within 30 working days after the receipt of all the evidence supporting the proposed change;
 - (3) assess the actions proposed by the service provider in order to show compliance; and
 - (4) notify the service provider of its approval/rejection without delay.
- (b) A simple management system documentation system status sheet should be maintained, which contains information on when an amendment was received by the competent authority and when it was approved, if applicable.
- (c) The competent authority should, in due time, verify the compliance of the service provider and, depending on the change, examine the need for prescribing any condition for the operation of it during the change.
- (d) For changes requiring prior approval, the competent authority may conduct an audit of the service provider in order to verify the service provider's compliance with the applicable requirements.
- (e) When notifying, the competent authority should also inform the service provider of the right of appeal, as exists under the applicable national legislation.

AMC2 ATM/ANS.AR.C.025(b) Changes

ED Decision 2017/001/R

CHANGE OF NAME OF THE SERVICE PROVIDER

Upon receipt of the notification and the relevant parts of the service provider's documentation as required by [Part-ATM/ANS.OR](#), the competent authority should reissue the certificate.

GM1 ATM/ANS.AR.C.025(b) Changes

ED Decision 2017/001/R

CHANGE OF NAME OF THE SERVICE PROVIDER

A name change alone does not require the competent authority to audit the organisation unless there is evidence that other aspects of the organisation have changed.

GM2 ATM/ANS.AR.C.025(b) Changes

ED Decision 2017/001/R

APPROPRIATE ACTION

Appropriate action by the competent authority may include suspension, limitation or revocation of the service provider's certificate.

AMC1 ATM/ANS.AR.C.025(c) Changes

ED Decision 2017/001/R

CHANGES NOT REQUIRING PRIOR APPROVAL

- (a) When the service provider submits the name of the nominee for the nominated persons in accordance with [AMC2 ATM/ANS.OR.A.040\(b\)](#), the competent authority should consider his or her qualification.
- (b) Upon receipt of a notification for a proposed change that does not require prior approval by the competent authority, it should acknowledge receipt of the notification in writing within 10 working days from receipt unless it is not specified under the relevant national legislation.

ATM/ANS.AR.C.030 Approval of change management procedures for functional systems

Regulation (EU) 2017/373

- (a) The competent authority shall review:
 - (1) change management procedures for functional systems or any material modification to those procedures submitted by the service provider in accordance with point [ATM/ANS.OR.B.010\(b\)](#);
 - (2) any deviation from the procedures referred to in point (1) for a particular change, when requested by a service provider in accordance with point [ATM/ANS.OR.B.010\(c\)\(1\)](#).
- (b) The competent authority shall approve the procedures, modifications and deviations referred to in point (a) when it has determined that they are necessary and sufficient for the service provider to demonstrate compliance with points [ATM/ANS.OR.A.045](#), [ATM/ANS.OR.C.005](#), [ATS.OR.205](#), and [ATS.OR.210](#), as applicable.

GM1 ATM/ANS.AR.C.030 Approval of change management procedures for functional systems

ED Decision 2017/001/R

GENERAL

The review by the competent authority is focused on the change management procedures and not on the project management part of these procedures that are not required by the regulations, even

though they may be useful for the smooth execution of the project dealing with the change. Consequently, not all parts of a procedure may be approved by the competent authority. The approved parts should be identified in the record (see [AMC1 ATM/ANS.AR.B.015\(a\)\(8\)](#)) and communicated to the service provider.

AMC1 ATM/ANS.AR.C.030(a) Approval of change management procedures for functional systems

ED Decision 2017/001/R

MEANS AND METHOD OF SUBMITTING PROCEDURES

The competent authority should agree with the service provider on the means and method of submitting the procedures, modifications and deviations referred to in [ATM/ANS.AR.C.030\(a\)](#). Until an agreement is reached, the competent authority will prescribe the means and method of submission.

AMC1 ATM/ANS.AR.C.030(b) Approval of change management procedures for functional systems

ED Decision 2017/001/R

APPROVAL OF PROCEDURES

- (a) When approving the change management procedures for functional systems as per [ATM/ANS.OR.B.010](#), the competent authority should perform the following:
- (1) check that the procedures used by a service provider to manage changes cover the life cycle of a change as defined in [ATM/ANS.OR.C.005\(a\)\(1\)](#) or [ATS.OR.205\(a\)\(1\)](#);
 - (2) use the compliance matrix provided by the service provider (referred to in [AMC1 ATM/ANS.OR.B.010\(a\)](#)), when reviewing the content of the procedures, modifications and/or deviations referred to in [ATM/ANS.AR.C.030\(a\)](#); as part of the oversight activity, the competent authority should check that the compliance matrix covers all the aforementioned requirements.
 - (3) check that the procedures make mandatory provisions that require actions to be undertaken and all required evidence to be produced to comply with requirements laid down in [ATM/ANS.OR.A.045](#), [ATM/ANS.OR.C.005](#), [ATS.OR.205](#) and [ATS.OR.210](#);
 - (4) check that the procedures identify the roles and responsibilities of the service provider in the change management processes;
 - (5) check that the procedures state that it is not allowed to use new, modified or deviating change management procedures until approval is granted; and
 - (6) check that the procedures state that any change selected for review must not enter into operational service before the approval is granted.
- (b) The competent authority should provide a response to the service provider's notification of change referred to in [ATM/ANS.OR.A.045\(a\)](#) without undue delay.

GM1 ATM/ANS.AR.C.030(b) Approval of change management procedures for functional systems

ED Decision 2017/001/R

DEVIATIONS

Some changes might stem from the need to implement immediate action and, therefore, their implementation cannot be delayed until they receive approval or communication that the change is not being reviewed from the competent authority such as changes due to urgent unforeseen circumstances that would, if uncorrected, lead to an immediate unsafe condition, presence of volcanic ash, etc.

The competent authority may consider this type of changes as part of the approval of change management procedures for functional systems.

ATM/ANS.AR.C.035 Decision to review a notified change to the functional system

Regulation (EU) 2017/373

- (a) Upon receipt of a notification in accordance with point [ATM/ANS.OR.A.045\(a\)\(1\)](#), or upon receipt of modified information in accordance with point [ATM/ANS.OR.A.045\(b\)](#), the competent authority shall make a decision on whether to review the change or not. The competent authority shall request any additional information needed from the service provider to support this decision.
- (b) The competent authority shall determine the need for a review based on specific, valid and documented criteria that, as a minimum, ensure that the notified change is reviewed if the combination of the likelihood of the argument being complex or unfamiliar to the service provider and the severity of the possible consequences of the change is significant.
- (c) When the competent authority decides the need for a review based on other risk based criteria in addition to point (b), these criteria shall be specific, valid and documented.
- (d) The competent authority shall inform the service provider of its decision to review a notified change to a functional system and provide the associated rationale to the service provider upon request.

AMC1 ATM/ANS.AR.C.035(a) Decision to review a notified change to the functional system

ED Decision 2017/001/R

MEANS AND METHOD OF SUBMITTING NOTIFICATION OF CHANGES TO FUNCTIONAL SYSTEMS

The competent authority should agree with the service provider on the means and method of submitting the notification of changes and additional information referred to in [ATM/ANS.OR.A.045\(a\)](#). Until an agreement is reached, the competent authority will prescribe the means of submission.

GM1 ATM/ANS.AR.C.035(b) Decision to review a notified change to the functional system

ED Decision 2017/001/R

SELECTION CRITERIA FOR REVIEWING A NOTIFIED CHANGE TO THE FUNCTIONAL SYSTEM

The need for review should be based on a combination of the likelihood that the safety (support) argument may be complex or unfamiliar to the service provider undertaking the change and the severity of the consequences associated with the change. This is a risk function and is referred to as the ‘risk posed by the change’.

The following two aspects of the change:

- the novelty of the change; and
- the capabilities of the service provider (e.g. the effectiveness of the service provider’s (safety) management system),

as well as the service provider performing the change contribute to the service provider’s unfamiliarity of the necessary argument. The assessment of the severity of the consequence is made at a very early stage in the development of the change and, therefore, will be based on coarse data. It should, therefore, be conservative.

The risk posed by a change could be a scalar measure associated with the change and be some combination of the two inputs: the probability of a complex or unfamiliar argument and the severity of the consequences of the proposed change. The result is that the risk posed by a particular change is the sum of the inputs.

One possibility may be based on the use of a risk matrix in which risk parameters are represented according to a coarse-grained measurement scheme, and the selection criteria establish the boundary beyond which changes will be selected for review, as shown below:

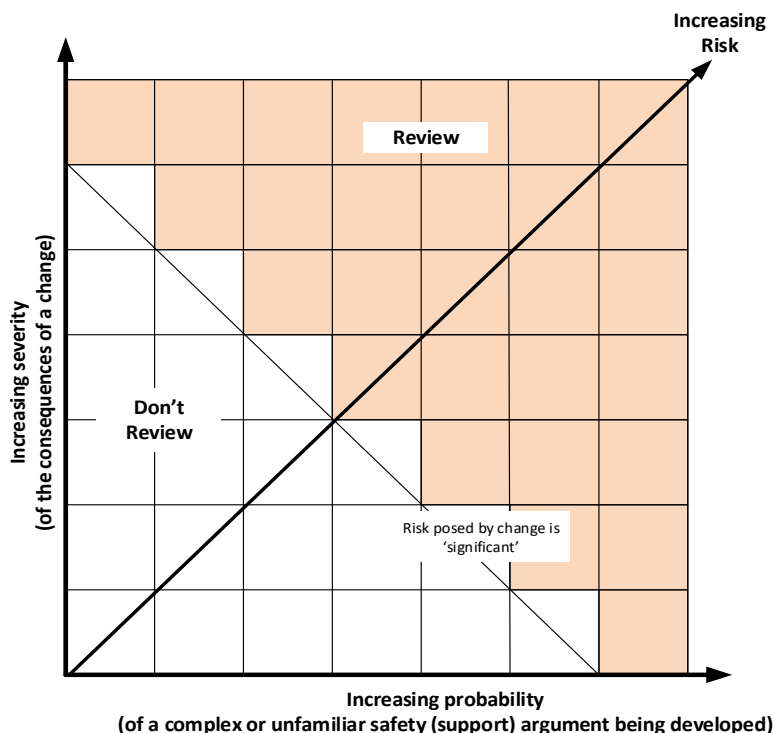

The selection criterion, a function of risk with the value ‘significant’, is then a straight line, if the scales are logarithmic.

GM1 ATM/ANS.AR.C.035(c) Decision to review a notified change to the functional system

ED Decision 2017/001/R

OTHER SELECTION CRITERIA

- (a) Some changes may not necessarily need to be reviewed providing that, even though they relate to safety, they can be considered as routine by the provider as they have been consistently assessed, implemented and proved safe in the past and, therefore, the competent authority has sufficient confidence that the provider will address them in a similar manner.
- (b) The selection criterion for review may deviate from a simple threshold on the scalar risk metric (distance from the origin), to deal with concerns due to the coarse grain and high uncertainty of the inputs. For instance, a separate threshold on the 'severity' axis may be used to specify, for instance:
 - (1) that changes with very high potential severity should always be reviewed, irrespective of the probability of the safety argument being incomplete and/or incorrect (Figure below). This criterion may well respond to common perceptions and could be justified by the fact that judgements of low probabilities based on limited information are often unreliable, and errors in the judgment of risk are proportional to the error on probability and the size of the loss; and
 - (2) that changes with minor potential severity need not be reviewed, irrespective of the probability of the safety argument being incomplete and/or incorrect (Figure below) (though the process may retain the option for the competent authority to review the change, since the estimate itself of potential severity may be suspected of being erroneous).
- (c) It is also possible that deviations be required on the basis of some of the component factors that affect either probability or severity, e.g. exempting changes based on small size of change and high competence of the air traffic services provider.
- (d) In order to validate the process or provide data for the evolution of the process, it may be advisable to randomly select changes to review and then assess whether the safety argument is complete and/or correct or not and whether or not the case would have been selected for review using the current criteria for the selection process.

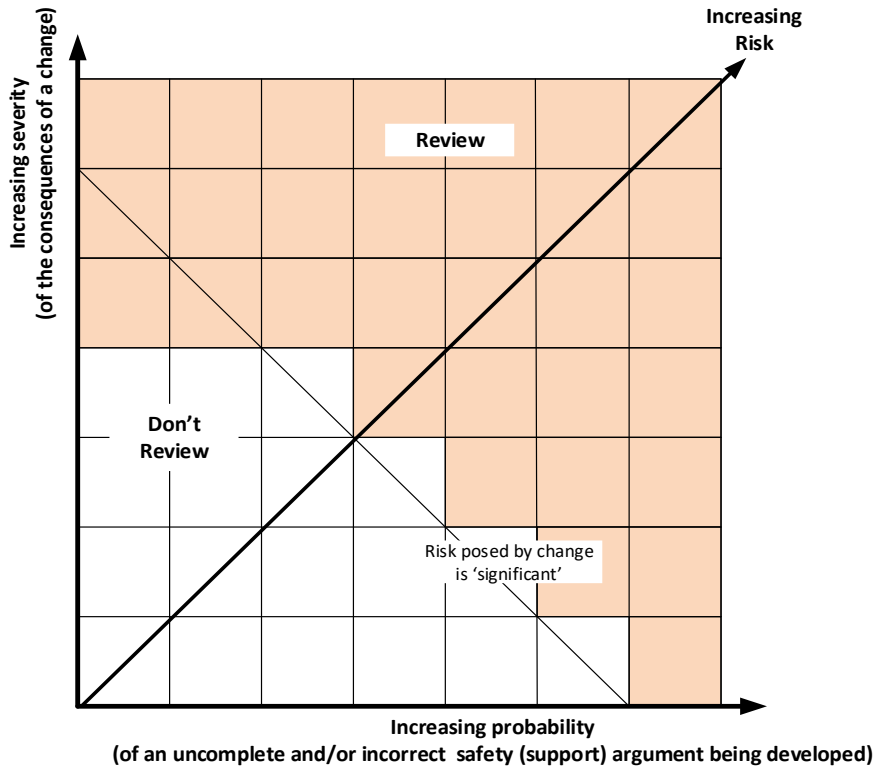

Figure 1: Criteria that may be used when severity is high

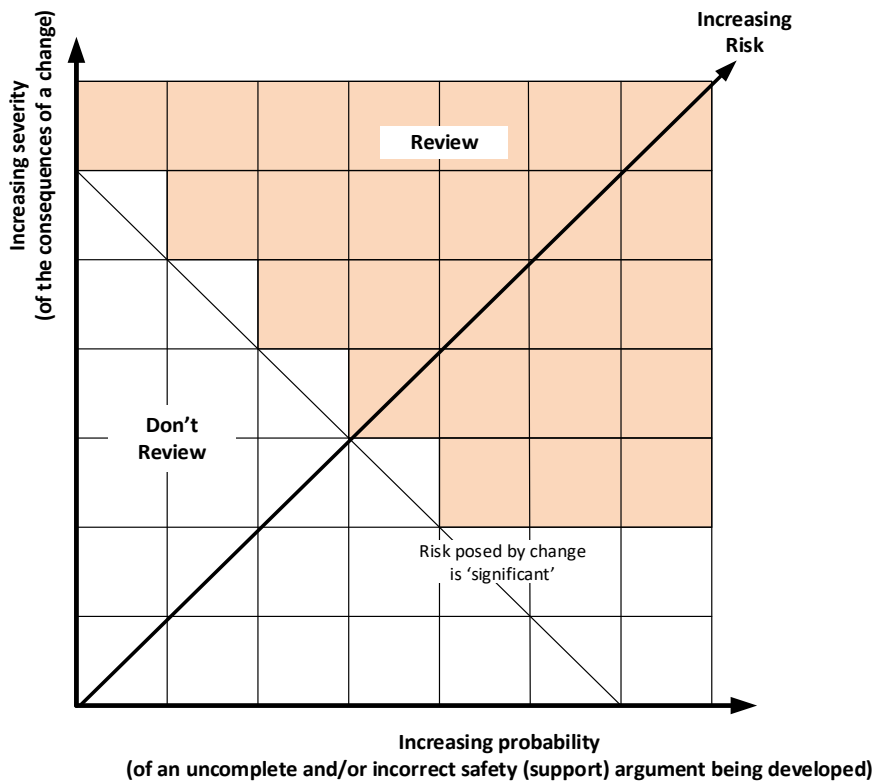

Figure 2: Criteria that may be used when severity is low

ATM/ANS.AR.C.040 Review of a notified change to the functional system

Regulation (EU) 2017/373

- (a) When the competent authority reviews the argument for a notified change, it shall:
 - (1) assess the validity of the argument presented with respect to point [ATM/ANS.OR.C.005\(a\)\(2\)](#) or [ATS.OR.205\(a\)\(2\)](#);
 - (2) coordinate its activities with other competent authorities whenever necessary.
- (b) The competent authority shall, alternatively:
 - (1) approve the argument referred to in point (a)(1), with conditions where applicable, when it is shown to be valid and so inform the service provider,
 - (2) reject the argument referred to in point (a)(1) and inform the service provider together with a supporting rationale.

ATM/ANS.AR.C.045 Declarations of flight information services providers

Regulation (EU) 2017/373

- (a) Upon receiving a declaration from a provider of flight information services intending to provide such services, the competent authority shall verify that the declaration contains all the information required by point [ATM/ANS.OR.A.015](#) and shall acknowledge receipt of the declaration to that service provider.
- (b) If the declaration does not contain the required information, or contains information that indicates non-compliance with the applicable requirements, the competent authority shall notify the provider of flight information services concerned about the non-compliance and request further information. If necessary, the competent authority shall carry out an audit of the provider of flight information services. If the non-compliance is confirmed, the competent authority shall take action provided for in point [ATM/ANS.AR.C.050](#).
- (c) The competent authority shall keep a register of the declarations of providers of flight information services which were made to it in accordance with this Regulation.

ATM/ANS.AR.C.050 Findings, corrective actions, and enforcement measures

Regulation (EU) 2017/373

- (a) The competent authority shall have a system to analyse findings for their safety significance and decide on enforcement measures on the basis of the safety risk posed by the service provider's non-compliance.
- (b) In circumstances where no or very low additional safety risk would be present with immediate appropriate mitigation measures, the competent authority may accept the provision of services to ensure continuity of service whilst corrective actions are being taken.
- (c) A level 1 finding shall be issued by the competent authority when any serious non-compliance is detected with the applicable requirements of [Regulation \(EC\) No 216/2008](#) and its implementing rules as well as Regulations [\(EC\) No 549/2004](#), [\(EC\) No 550/2004](#), [\(EC\) No 551/2004](#), and [\(EC\) No 552/2004](#) and their implementing rules, with the service provider's

procedures and manuals, with the terms of conditions of certificate or certificate, with the designation act, if applicable, or with the content of a declaration which poses a significant risk to flight safety or otherwise calls into question the service provider's capability to continue operations.

Level 1 findings shall include but not be limited to:

- (1) promulgating operational procedures and/or providing a service in a way which introduces a significant risk to flight safety;
 - (2) obtaining or maintaining the validity of the service provider's certificate by falsification of submitted documentary evidence;
 - (3) evidence of malpractice or fraudulent use of the service provider's certificate;
 - (4) the lack of an accountable manager.
- (d) A level 2 finding shall be issued by the competent authority when any other non-compliance is detected with the applicable requirements of Regulation (EC) No 216/2008 and its implementing rules as well as Regulations (EC) No 549/2004, (EC) No 550/2004, (EC) No 551/2004, and (EC) No 552/2004 and their implementing rules, with the service provider's procedures and manuals or with the terms of conditions or certificate, or with the content of a declaration.
- (e) When a finding is detected, during oversight or by any other means, the competent authority shall, without prejudice to any additional action required by [Regulation \(EC\) No 216/2008](#) and this Regulation, as well as Regulations (EC) No 549/2004, (EC) No 550/2004, (EC) No 551/2004 and (EC) No 552/2004 and their implementing rules, communicate the finding to the service provider in writing and require corrective action to address the non-compliance(s) identified.
- (1) In the case of level 1 findings, the competent authority shall take immediate and appropriate action, and may, if appropriate, limit, suspend or revoke in whole or in part the certificate while ensuring the continuity of services provided that safety is not compromised, and in the case of the Network Manager, it shall inform the Commission. The measure taken shall depend upon the extent of the finding and shall remain until successful corrective action has been taken by the service provider.
 - (2) In the case of level 2 findings, the competent authority shall:
 - (i) grant the service provider a corrective action implementation period included in an action plan appropriate to the nature of the finding;
 - (ii) assess the corrective action and implementation plan proposed by the service provider and, if the assessment concludes that they are sufficient to address the non-compliance(s), accept them.
 - (3) In the case of level 2 findings, where the service provider fails to submit a corrective action plan that is acceptable to the competent authority in light of the finding, or where the service provider fails to perform the corrective action within the time period accepted or extended by the competent authority, the finding may be raised to a level 1 finding, and action taken as laid down in point (1).
- (f) For those cases not requiring level 1 and 2 findings, the competent authority may issue observations.

GM1 ATM/ANS.AR.C.050 Findings, corrective actions, and enforcement measures

ED Decision 2017/001/R

CATEGORIES OF FINDINGS — DOCUMENTARY EVIDENCE

Documentary evidence may include but is not limited to:

- (a) operations or technical manuals;
- (b) contracts or other types of arrangements;
- (c) training, qualification or medical records;
- (d) inspection records;
- (e) test or exercise results;
- (f) internal audit results;
- (g) maintenance records; and
- (h) other similar material required to be maintained by the service provider, etc.

GM2 ATM/ANS.AR.C.050 Findings, corrective actions, and enforcement measures

ED Decision 2017/001/R

ENFORCEMENT MEASURES — FINANCIAL PENALTIES

In accordance with Article 7(7) of [Regulation No 550/2004](#) and Articles 10, 22a(d), 25, and 68 of [Regulation \(EC\) No 216/2008](#), the competent authority may additionally, and depending on the nature and the repetitiveness of the findings or the level of implementation of the corrective actions, impose appropriate enforcement measures that may include financial penalties, which are effective, proportionate, and dissuasive.

AMC1 ATM/ANS.AR.C.050(e) Findings, corrective actions, and enforcement measures

ED Decision 2017/001/R

CORRECTIVE ACTION AND CORRECTIVE ACTION IMPLEMENTATION PERIOD — DAT PROVIDERS

- (a) In case of a Level 1 finding, the competent authority may extend the initial 21-working-day period for demonstration of corrective action by the DAT provider, depending on the nature of the finding.
- (b) In case of a Level 2 finding, the initial corrective action implementation period granted by the competent authority should be appropriate to the nature of the finding but should not, in any case, exceed 3 months. At the end of this period and subject to the nature of the finding, the competent authority may extend the 3-month period subject to a satisfactory corrective action plan agreed by the competent authority.

GM1 ATM/ANS.AR.C.050(e) Findings, corrective actions, and enforcement measures

ED Decision 2017/001/R

CORRECTIVE ACTION IMPLEMENTATION PERIOD

At the end of the corrective action implementation period included in an action plan approved by the competent authority and subject to the nature of the finding, the competent authority may extend it. It should be subject to a satisfactory corrective action plan agreed by the competent authority.

GM1 ATM/ANS.AR.C.050(f) Findings, corrective actions, and enforcement measures

ED Decision 2017/001/R

OBSERVATIONS

The observation should be a way to communicate and draw future audit teams' attention on specific matters that deserve scrutiny. It should be communicated to the audited service provider.

APPENDICES TO ANNEX II

Appendix 1 — EASA Form 157

Commission Implementing Regulation (EU) 2020/469

CERTIFICATE FOR SERVICE PROVIDER

EUROPEAN UNION

COMPETENT AUTHORITY

SERVICE PROVIDER CERTIFICATE

[CERTIFICATE NUMBER/ISSUE No]

Pursuant to Implementing Regulation (EU) 2017/373 and subject to the conditions specified below, the [competent authority] hereby certifies

[NAME OF THE SERVICE PROVIDER]

[ADDRESS OF THE SERVICE PROVIDER]

as a service provider with the privileges, as listed in the attached service provision conditions.

CONDITIONS:

This certificate is issued subject to the conditions and the scope of providing services and functions as listed in the attached service provision conditions.

This certificate is valid whilst the certified service provider remains in compliance with Implementing Regulation (EU) 2017/373 and the other applicable regulations and, when relevant, with the procedures in the service provider's documentation.

Subject to compliance with the foregoing conditions, this certificate shall remain valid unless the certificate has been surrendered, limited, suspended or revoked.

Date of issue:

Signed:

[Competent authority]

SERVICE PROVIDER			
CERTIFICATE			
SERVICE PROVISION CONDITIONS			
Attachment to service provider's certificate:			
[CERTIFICATE NUMBER/ISSUE No]			
[NAME OF THE SERVICE PROVIDER]			
has obtained the privileges to provide the following scope of services/functions:			
(Delete lines as appropriate)			
Services/Functions	Type of Service/Function	Scope of Service/Function	Limitations ¹
Air traffic services (ATS) ²	Air traffic control (ATC)	Area control service	
		Approach control service	
		Aerodrome control service	
	Flight information service (FIS)	Aerodrome flight information service (AFIS)	
		En-route flight information service (En-route FIS)	
Advisory service	n/a		
Air traffic flow management (ATFM)	ATFM	Provision of the local ATFM	
Airspace management (ASM)	ASM	Provision of the local ASM (tactical/ASM Level 3) service	
Conditions ³			

Services/Functions	Type of Service/Function	Scope of Service/Function	Limitations ¹
Air traffic services (ATS) for flight test ^{1,4}	Air traffic control (ATC)	Area control service	
		Approach control service	
		Aerodrome control service	
	Flight information service (FIS)	Aerodrome flight information service (AFIS)	
		En-route flight information service (En-route FIS)	
Advisory service	n/a		
Conditions ¹			

¹ As prescribed by the competent authority.

² ATS covers alerting service.

³ Where necessary.

⁴ If the competent authority considers it necessary to establish additional requirements.

Services/Functions	Type of Service/Function	Scope of Service/Function	Limitations ¹
Communication, navigation or surveillance services (CNS)	Communications (C)	Aeronautical mobile service (air-ground communication)	
		Aeronautical fixed service (ground-ground communications)	
		Aeronautical mobile satellite service (AMSS)	
	Navigation (N)	Provision of NDB signal in space	
		Provision of VOR signal in space	
		Provision of DME signal in space	
		Provision of ILS signal in space	
		Provision of MLS signal in space	
		Provision of GNSS signal in space	
	Surveillance (S)	Provision of data from primary surveillance (PS)	
Provision of data from secondary surveillance (SS)			
Provision of automatic dependent surveillance (ADS) Data			
Conditions ²			

Services/Functions	Type of Service/Function	Scope of Service/Function	Limitations ¹
Aeronautical information services (AIS)	Aeronautical information products (including distribution services)	Aeronautical information publication (AIP)	
		Aeronautical information circular (AIC)	
		NOTAM	
		AIP data set	
		Obstacle data sets	
		Aerodrome mapping data sets	
		Instrument flight procedure data sets	
	Preflight information services	n/a	
Conditions ¹			

Services/Functions	Type of Service/Function	Scope of Service/Function	Limitations ¹
Data services (DAT)	Type 1	Provision of Type 1DAT authorises the supply of aeronautical databases in the following formats: [list of the generic data formats] Provision of Type 1 DAT does not authorise the supply of aeronautical databases directly to end-users/ aircraft operators.	
	Type 2	Provision of Type 2 DAT authorises the supply of aeronautical databases to end-users/aircraft operators for the following airborne application/	

¹ As prescribed by the competent authority.

² Where necessary.

		equipment, for which compatibility has been demonstrated: [Manufacturer] Certified Application/ Equipment model [XXX], Part No [YYY]	
Conditions ¹			

Services/Functions	Type of Service/Function	Scope of Service/Function	Limitations ¹
Meteorological services (MET)	MET	Meteorological watch office	
		Aerodrome meteorological offices	
		Aeronautical meteorological stations	
		VAAC	
		WAFC	
		TCAC	
Conditions ²			

Services/Functions	Type of Service/Function	Scope of Service/Function	Limitations ¹
Flight procedure design (FPD)	Design, documentation and validation of flight procedures ³	n/a	
Conditions ¹			

Services/Functions	Type of Service/Function	Scope of Service/Function	Limitations ¹
ATM network functions	Design of ERN	n/a	
	Scarce resources	Radio frequency	
		Transponder code	
	ATFM	Provision of the central ATFM	
Conditions ¹			
<p>Date of issue:</p> <p>Signed: [Competent authority]</p> <p>For the Member State/EASA</p>			

EASA Form 157 Issue 1 — Page 4/4

¹ As prescribed by the competent authority.

² Where necessary.

³ Design, documentation and validation of flight procedures includes maintenance and periodic review activities.

ANNEX III — PART-ATM/ANS.OR

ANNEX III COMMON REQUIREMENTS FOR SERVICE PROVIDERS (PART-ATM/ANS.OR)

SUBPART A — GENERAL REQUIREMENTS (ATM/ANS.OR.A)

ATM/ANS.OR.A.001 Scope

Regulation (EU) 2017/373

In accordance with [Article 6](#), this Annex establishes the requirements to be met by the service providers.

GM1 ATM/ANS.OR.A.001 Scope

ED Decision 2020/008/R

DEFINITIONS AND SCOPE IN RELATION TO SERVICE PROVIDERS

- (a) To recognise which of the annexes applies to which service provider, it is necessary to understand how services are defined. These definitions have determined the structure and the content of Annexes III to XIII.
- (b) Article 3(q) of [Regulation \(EC\) No 216/2008](#) defines ATM/ANS as ‘the air traffic management functions as defined in Article 2(10) of [Regulation \(EC\) No 549/2004](#), air navigation services defined in Article 2(4) of that Regulation, and services consisting in the origination and processing of data and formatting and delivering data to general air traffic for the purpose of safety-critical air navigation’.
- (c) It should, therefore, be noted that ATM/ANS include more services than ‘Air Traffic Management’ and ‘Air Navigation Services’ together.
- (d) In this Regulation, ‘services’ refers to those specified in Annex VIII(2) to [Regulation \(EU\) 2018/1139](#).
- (e) As already defined, ‘ATM network functions’ refers to functions performed by the Network Manager in accordance with [Regulation \(EU\) No 677/2011](#)¹.
- (f) Figure 1 below provides a pictorial representation of the services and how they interrelate through the various definitions.
- (g) Figure 1 indicates both a further breakdown of ATS into air traffic control services (ATC), alerting services, air traffic advisory services, and flight information services and groupings of:
 - (1) air traffic management (ATM): comprising ATS, ASM, and ATFM;
 - (2) air navigation services (ANS): comprising ATS, CNS, MET, and AIS; and
 - (3) flight procedure design services (FPD) and data services (DAT) and ATM network functions.

¹ Commission Regulation (EU) No 677/2011 of 7 July 2011 laying down detailed rules for the implementation of air traffic management (ATM) network functions and amending Commission Regulation (EU) No 691/2010 (OJ L 185, 15.7.2011, p. 1).

(h) It is important to note that ATS is included in ATM and ANS.

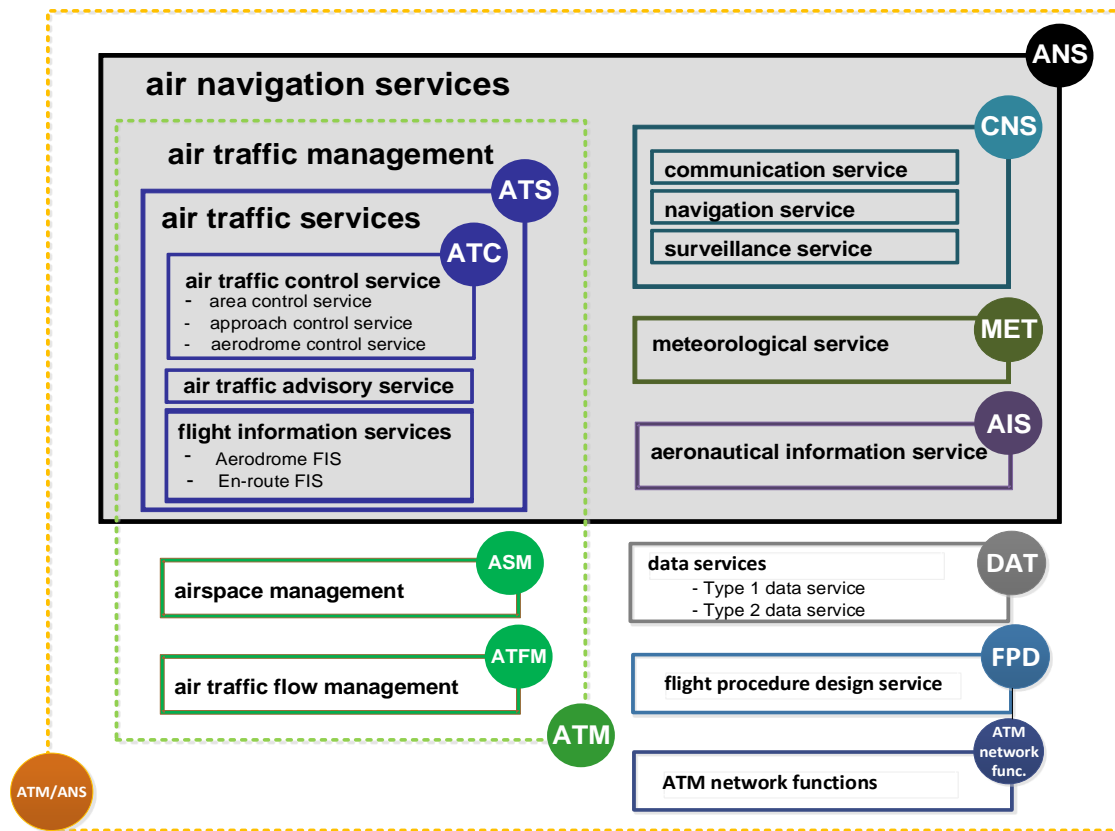

Figure 1: The scope of the services, subject to certification, as specified in Regulation (EU) 2018/1139.

SERVICES

- (a) [Annex III](#) (Part-ATM/ANS.OR) applies to the service providers, as relevant, and contains the common requirements for the service providers. This Annex is broken down into four subparts:
- (1) Subpart A — General requirements (ATM/ANS.OR.A);
 - (2) Subpart B — Management (ATM/ANS.OR.B);
 - (3) Subpart C — Specific organisational requirements for service providers other than ATS providers (ATM/ANS.OR.C); and
 - (4) Subpart D — Specific organisational requirements for ANS and ATFM providers and the Network Manager (ATM/ANS.OR.D).
- (b) Subpart D applies only to ANS and ATFM providers and the Network Manager (and not to ASM and DAT providers).
- (c) Thereafter, each specific requirement for various service providers is allocated to an annex (Annexes IV to XII) which contains specific requirements for that service provider. Table 1 below indicates which annexes are applicable to each service provided.
- (d) [Annex XIII](#) contains requirements for service providers regarding personnel training and competence assessment.

AIR TRAFFIC SERVICES FOR FLIGHT TEST

- (a) When the flight tests have one of the following characteristics:
- (1) frequent changes in levels and headings, depending on the tests which are carried out with certain unpredictability;
 - (2) unless necessary for the purpose of the flight tests, navigation in general (route/destination, etc.) is not the primary objective of these flights;
 - (3) specific aircraft configurations sometimes resulting in reduced ability to manoeuvre;
 - (4) technical constraints, including airborne and ground testing facilities;
 - (5) airborne equipment is not proven to be up to the required certification level; and
 - (6) the planning for conducting flight tests can be of a very ad hoc nature giving little timing for carrying out strategy or pre-tactical air traffic flow management. (e.g. the need to test under specific weather conditions which would require flexibility for allocation of slots for these flight tests),

then the air traffic services provider providing services to this type of flight testing may need a specific privilege within the certificate issued by the competent authority because of the specificities of the air traffic services to be provided to this type of operations and because of the need to ensure safe operations in the airspace in which flight tests are being conducted.

- (b) Given the characteristics in (a), flight tests can be made in cohabitation with other airspace users in controlled or non-controlled airspace, and sometimes in temporarily reserved areas when necessary.

	Annex III (Part-ATM/ANS.OR)				Annex IV (Part-ATS)	Annex V (Part-MET)	Annex VI (Part-AIS)	Annex VII (Part-DAT)	Annex VIII (Part-CNS)	Annex IX (Part-ATFM)	Annex X (Part-ASM)	Annex XI (Part-FPD)	Annex XII (Part-NM)	Annex XIII (Part-PERS)
	Subpart A	Subpart B	Subpart C	Subpart D										
Air traffic services providers (see Note 1)	X	X		X	X									
Meteorological services providers	X	X	X	X		X								
Aeronautical information services providers	X	X	X	X			X							
Data services providers	X	X	X					X						
Communication, navigation and surveillance service providers	X	X	X	X					X					
Air traffic flow management service providers	X	X	X	X						X				
Airspace management service providers	X	X	X								X			
Flight procedure design services providers	X	X	X									X		
Network Manager service providers (see Note 2)	X	X	X	X									X	
														X

Table 1: Applicability of annexes to service providers

X = Applicable annexes for each service provider.

Note 1: Section 3 of Annex IV (Part-ATS) only applies to providers of air traffic control services and not to providers of alerting, air traffic advisory, and flight information services.

Note 2: The applicability of Annex XIII is dependent upon the scope as specified within each of the subparts of Annex XIII.

ATM/ANS.OR.A.005 Application for a service provider certificate

Regulation (EU) 2017/373

- (a) Application for a service provider certificate or an amendment to an existing certificate shall be made in a form and manner established by the competent authority, taking into account the applicable requirements of this Regulation.
- (b) In accordance with [Article 6](#), in order to obtain the certificate, the service provider shall comply with:
 - (1) the requirements referred to in Article 8b(1) of [Regulation \(EU\) No 216/2008](#);
 - (2) the common requirements set out in this Annex;
 - (3) the specific requirements set out in Annexes IV to XIII, where those requirements are applicable in light of the services that the service provider provides or plans to provide.

AMC1 ATM/ANS.OR.A.005 Application for a service provider certificate

ED Decision 2017/001/R

EXPOSITION — DAT PROVIDERS

- (a) The DAT provider should submit to the competent authority an exposition providing the following information:
 - (1) a statement signed by the accountable manager confirming that the exposition and any associated manuals which define the organisation's compliance with the requirements will be complied with at all times;
 - (2) the duties and responsibilities of the manager(s) as required by [ATM/ANS.OR.B.020](#) including matters on which they may deal directly with the competent authority on behalf of the organisation;
 - (3) an organisational chart showing lines of responsibility and accountability throughout the DAT provider, including a direct accountability of the accountable manager as required by [ATM/ANS.OR.B.005\(a\)\(1\)](#);
 - (4) a list of attesting staff as referred to in [DAT.TR.100\(b\)](#);
 - (5) a general description of manpower resources;
 - (6) a general description of the facilities of the DAT provider;
 - (7) a general description of the activities for which the DAT provider's certificate is requested;
 - (8) the procedure for the notification of organisational changes to the competent authority;
 - (9) the amendment procedure for the exposition;
 - (10) a description of the management system and the procedures as required by [DAT.OR.110](#); and
 - (11) a list of those contracted organisations referred to in [ATM/ANS.OR.B.015\(b\)](#).
- (b) The exposition should be amended as necessary to remain an up-to-date description of the organisation, and copies of any amendments should be supplied to the competent authority.

GM1 to AMC1 ATM/ANS.OR.A.005 Application for a service provider certificate

ED Decision 2017/001/R

EXPOSITION — DAT PROVIDERS

The exposition should contain the following table of contents:

1. **General**
Table of contents, document revision history, abbreviations, and terms.
2. **Introduction**
Purpose, scope, standards declaration, and reference documents.
3. **Company description and policy**
Description of the company, products and services, quality policy and objectives, customer requirements.
4. **Terms of approval**
Scope of work, notification of changes to the terms of approval, control of documents and records.
5. **Management/resources responsibilities**
Management team and personnel, organisation charts, duties and responsibilities of personnel.
Management review, human resources, competence, awareness, and training.
6. **Production processes**
Data production procedures, arrangements with suppliers, users/customers and other DAT providers, data receiving inspection and testing, data release, data distribution process, data products identification and quality checks, tailored data, data error reporting.
7. **Management system**
Introduction, document control, quality assurance, internal system audits, standards compliance plan audits, methods of improvement, occurrence management and reporting, record-keeping.
8. **Appendix 1 — List of relevant personnel**

GM2 to AMC1 ATM/ANS.OR.A.005 Application for a service provider certificate

ED Decision 2017/001/R

EXPOSITION — DAT PROVIDERS

A means to develop the exposition may be by cross-referring to the procedures of the quality manual, which are needed to demonstrate compliance with these requirements.

GM3 ATM/ANS.OR.A.005 Application for a service provider certificate

ED Decision 2020/008/R

GENERAL — AIS PROVIDER

Terrain data sets are part of the digital data sets, but are typically originated and maintained by organisations different than AIS providers. The provision of terrain data sets by an AIS provider for the purpose of air navigation is consequently limited to the mere distribution of a finished product or even only the provision of information on how the product can be obtained, in accordance with the applicable requirements of Regulation (EU) 2017/373.

ATM/ANS.OR.A.010 Application for a limited certificate

Regulation (EU) 2017/373

- (a) Notwithstanding point (b), the air traffic services provider may apply for a certificate limited to the provision of services in the airspace under the responsibility of the Member State where its principal place of operation or, if any, registered office is located, when it provides or plans to provide services only with respect to one or more of the following categories:
- (1) aerial work;
 - (2) general aviation;
 - (3) commercial air transport limited to aircraft with less than 10 tonnes of maximum take-off mass or less than 20 passenger seats;
 - (4) commercial air transport with less than 10 000 movements per year, regardless of the maximum take-off mass and the number of passenger seats; for the purposes of this provision, 'movements' means, in a given year, the average over the previous three years of the total number of take-offs and landings.
- (b) In addition, the following air navigation service providers may also apply for a limited certificate:
- (1) an air navigation service provider, other than a provider of air traffic services, with a gross annual turnover of EUR 1 000 000 or less in relation to the services they provide or plan to provide;
 - (2) an air navigation service provider providing aerodrome flight information services by operating regularly not more than one working position at any aerodrome.
- (c) As determined by the competent authority, an air navigation service provider applying for a limited certificate in accordance with points (a) or (b)(1) shall comply, as a minimum, with the following requirements set out in:
- (1) point [ATM/ANS.OR.B.001](#) Technical and operational competence and capability;
 - (2) point [ATM/ANS.OR.B.005](#) Management system;
 - (3) point [ATM/ANS.OR.B.020](#) Personnel requirements;
 - (4) point [ATM/ANS.OR.A.075](#) Open and transparent provision of services;
 - (5) Annexes IV, V, VI and VIII, where those requirements are applicable in light of the services that the service provider provides or plans to provide, in accordance with [Article 6](#).

- (d) As determined by the competent authority, the air navigation service provider applying for a limited certificate in accordance with point (b)(2) shall comply, as a minimum, with the requirements set out in points (c)(1) to (c)(4) and with the specific requirements set out in [Annex IV](#).
- (e) An applicant for a limited certificate shall submit an application to the competent authority in a form and manner established by the competent authority.

GM1 ATM/ANS.OR.A.010 Application for a limited certificate

ED Decision 2017/001/R

GENERAL

The relationship between the type of service provision, criteria to be complied with and the applicable rules are indicated in Table 2 below.

Type of service	Type of approval	Criteria to be complied with	Applicable Rules
Air traffic service providers	Limited Certificate	ATM/ANS.OR.A.010(a)	ATM/ANS.OR.B.001 ATM/ANS.OR.B.005 ATM/ANS.OR.B.020 ATM/ANS.OR.A.075 Annex IV
Air navigation service providers (other than the air traffic services providers) (gross annual turnover of EUR 1 000 000 or less)	Limited Certificate	ATM/ANS.OR.A.010(b)(1)	ATM/ANS.OR.B.001 ATM/ANS.OR.B.005 ATM/ANS.OR.B.020 ATM/ANS.OR.A.075 Annexes V, VI and VIII depending upon service provision
Air navigation service providers (aerodrome flight information services providers operating regularly not more than one working position at any aerodrome)	Limited Certificate	ATM/ANS.OR.A.010(b)(2)	ATM/ANS.OR.B.001 ATM/ANS.OR.B.005 ATM/ANS.OR.B.020 ATM/ANS.OR.A.075 Annex IV

Table 2: Type of service provision, criteria to be complied with, and the applicable rules

ATM/ANS.OR.A.015 Declaration by flight information services providers

Regulation (EU) 2017/373

- (a) Pursuant to [Article 7](#), a flight information services provider may declare its capability and means of discharging the responsibilities associated with the services provided where it meets, in addition to the requirements referred to in Article 8b(1) of Regulation (EU) No 216/2008, the following alternative requirements:
- (1) the flight information services provider provides, or plans to provide, its services by operating regularly not more than one working position;
 - (2) those services are of a temporary nature, for a duration agreed with the competent authority as necessary to ensure proportional safety assurance.

-
- (b) A flight information services provider declaring its activities shall:
- (1) provide the competent authority with all the relevant information prior to commencing operations, in a form and manner established by the competent authority;
 - (2) provide the competent authority with a list of the alternative means of compliance used, in accordance with point [ATM/ANS.OR.A.020](#);
 - (3) maintain compliance with the applicable requirements and with the information given in the declaration;
 - (4) notify the competent authority of any changes to its declaration or the means of compliance it uses through submission of an amended declaration;
 - (5) provide its services in accordance with its operations manual and comply with all the relevant provisions contained therein.
- (c) Before ceasing the provision of its services, the flight information services provider declaring its activities shall notify the competent authority within a period determined by the competent authority.
- (d) A flight information services provider declaring its activities shall comply with the following requirements set out in:
- (1) point [ATM/ANS.OR.A.001](#) Scope;
 - (2) point [ATM/ANS.OR.A.020](#) Means of compliance;
 - (3) point [ATM/ANS.OR.A.035](#) Demonstration of compliance;
 - (4) point [ATM/ANS.OR.A.040](#) Changes — general;
 - (5) point [ATM/ANS.OR.A.045](#) Changes to the functional system;
 - (6) point [ATM/ANS.OR.A.050](#) Facilitation and cooperation;
 - (7) point [ATM/ANS.OR.A.055](#) Findings and corrective actions;
 - (8) point [ATM/ANS.OR.A.060](#) Immediate reaction to a safety problem;
 - (9) point [ATM/ANS.OR.A.065](#) Occurrence reporting;
 - (10) point [ATM/ANS.OR.B.001](#) Technical and operational competence and capability;
 - (11) point [ATM/ANS.OR.B.005](#) Management system;
 - (12) point [ATM/ANS.OR.B.020](#) Personnel requirements;
 - (13) point [ATM/ANS.OR.B.035](#) Operations manuals;
 - (14) point [ATM/ANS.OR.D.020](#) Liability and insurance cover,
 - (15) [Annex IV](#).
- (e) A flight information services provider declaring its activities shall only start operation after receiving the acknowledgement of receipt of the declaration from the competent authority.

GM1 ATM/ANS.OR.A.015(b)(1) Declaration by flight information services providers

ED Decision 2017/001/R
MODEL TEMPLATE OF DECLARATION OF COMPLIANCE

DECLARATION OF COMPLIANCE FOR THE PROVISION OF FLIGHT INFORMATION SERVICES in accordance with Commission Implementing Regulation (EU) 2017/373
Provider of flight information service Name: Principal place of operation and, if any, registered office: Name and contact details of the accountable manager:
Flight Information Service Starting date of provision of flight information services/applicability date of the change: Scope of flight information services: <input type="checkbox"/> Aerodrome flight information services (AFIS) <input type="checkbox"/> En-route flight information services (En-route FIS)
List of alternative means of compliance with references to the AMCs they replace (to be attached to the declaration)
Statements <input type="checkbox"/> The management system documentation, including the operations manual, complies with the applicable requirements set out in Part-ATM/ANS.OR and Part-ATS. <input type="checkbox"/> The provision of flight information services will be carried out in accordance with the requirements of Regulation (EC) No 216/2008 and its implementing rules, as well as Regulations (EC) Nos 549/2004, 550/2004, 551/2004, and 552/2004 and their implementing rules, and the procedures and instructions specified in the operations manual. <input type="checkbox"/> All personnel are qualified, competent and trained in accordance with the applicable requirements.
<input type="checkbox"/> (If applicable) The provider of flight information services has implemented and demonstrated conformance to an officially recognised industry standard. Reference of the standard: Certification body: Date of the last conformance audit:
<input type="checkbox"/> Any change in the provision of flight information services that affects the information disclosed in this declaration will be notified to the competent authority.
<input type="checkbox"/> The provider of flight information service confirms that the information disclosed in this declaration is correct.
Date, name, and signature of the accountable manager

ATM/ANS.OR.A.020 Means of compliance

Regulation (EU) 2017/373

- (a) Alternative means of compliance (AltMOC) to the AMC adopted by the Agency may be used by the service provider to establish compliance with the requirements of this Regulation.
- (b) When the service provider wishes to use an AltMOC, it shall, prior to implementing it, provide the competent authority with a full description of the AltMOC. The description shall include any revisions to manuals or procedures that may be relevant, as well as an assessment demonstrating compliance with the requirements of this Regulation.

A service provider may implement these alternative means of compliance subject to prior approval by the competent authority and upon receipt of the notification as prescribed in point [ATM/ANS.AR.A.015\(d\)](#).

ATM/ANS.OR.A.025 Continued validity of a certificate

Regulation (EU) 2017/373

- (a) A service provider's certificate shall remain valid subject to:
 - (1) the service provider remaining in compliance with the applicable requirements of this Regulation, including those concerning facilitating and cooperating for the purposes of the exercise of the powers of the competent authorities and those concerning the handling of findings as specified in points [ATM/ANS.OR.A.050](#) and [ATM/ANS.OR.A.055](#) respectively;
 - (2) the certificate not having been surrendered, suspended or revoked.
- (b) Upon revocation or surrender, the certificate shall be returned to the competent authority without delay.

ATM/ANS.OR.A.030 Continued validity of a declaration of a flight information services provider

Regulation (EU) 2017/373

A declaration made by the flight information services provider in accordance with point [ATM/ANS.OR.A.015](#) shall remain valid subject to:

- (a) the flight information services remaining in compliance with the applicable requirements of this Regulation, including those concerning facilitating and cooperating for the purposes of the exercise of the powers of the competent authorities and those concerning the handling of findings as specified in point [ATM/ANS.OR.A.050](#) and [ATM/ANS.OR.A.055](#) respectively;
- (b) the declaration not having been withdrawn by the provider of such services or deregistered by the competent authority.

ATM/ANS.OR.A.035 Demonstration of compliance

Regulation (EU) 2017/373

A service provider shall provide all the relevant evidence to demonstrate compliance with the applicable requirements of this Regulation at the request of the competent authority.

AMC1 ATM/ANS.OR.A.035 Demonstration of compliance

ED Decision 2017/001/R

EVIDENCE — DAT PROVIDERS

The exposition as referred to in [AMC1 ATM/ANS.OR.A.005](#) 'Application for service provider certificate' EXPOSITION — DAT PROVIDERS should be considered as one of the means to demonstrate compliance with the applicable requirements.

GM1 ATM/ANS.OR.A.035 Demonstration of compliance

ED Decision 2017/001/R

GENERAL — DAT PROVIDERS

In order to demonstrate compliance with the applicable requirements, the DAT provider should produce a compliance matrix/checklist detailing how its data production processes relate to EUROCAE ED-76A/RTCA DO-200B 'Standards for Processing Aeronautical Data', dated June 2015. EUROCAE ED-76/RTCA DO-200A may be also used for the demonstration of compliance.

GM2 ATM/ANS.OR.A.035 Demonstration of compliance

ED Decision 2020/008/R

RELEVANT EVIDENCE

[ATM/ANS.OR.B.005\(e\)](#) requires 'The management system shall be proportionate to the size of the service provider and the complexity of its activities, taking into account the hazards and associated risks inherent in those activities.' Consequently, the relevant evidence to demonstrate compliance with the applicable requirements of this Regulation should be also proportionate to the size of the service provider and the complexity of its activities.

ATM/ANS.OR.A.040 Changes — general

Regulation (EU) 2017/373

- (a) The notification and management of:
- (1) a change to the functional system or a change that affects the functional system shall be carried out in accordance with point [ATM/ANS.OR.A.045](#);
 - (2) a change to the provision of service, the service provider's management system and/or safety management system, that does not affect the functional system, shall be carried out in accordance with point (b).
- (b) Any change as referred to in point (a)(2) shall require prior approval before implementation, unless such a change is notified and managed in accordance with a procedure approved by the competent authority as laid down in point [ATM/ANS.AR.C.025\(c\)](#).

AMC1 ATM/ANS.OR.A.040 Changes — general

ED Decision 2017/001/R

CHANGE OF THE OWNERSHIP AND/OR THE LOCATION

A change of the service provider's ownership and/or the location of its facilities should comply with [ATM/ANS.OR.A.040\(a\)\(2\)](#) and should not be subject to the procedure identified in [ATM/ANS.AR.C.025\(c\)](#).

AMC1 ATM/ANS.OR.A.040(b) Changes — general

ED Decision 2017/001/R

PROCEDURE FOR CHANGES REQUIRING PRIOR APPROVAL

For changes requiring prior approval, a procedure should define how the service provider should notify the competent authority and obtain an approval issued by that authority:

- (a) Notifications should be submitted before any such change is made in order to enable the competent authority to determine continued compliance with [Regulation \(EC\) No 216/2008](#) and its implementing rules and also to amend, if necessary, the certificate and the related conditions attached to it.
- (b) Changes should only be implemented upon receipt of approval by the competent authority in accordance with the procedure established by that authority.
- (c) The service provider should operate under the conditions prescribed by the competent authority during such changes, as applicable.

AMC2 ATM/ANS.OR.A.040(b) Changes — general

ED Decision 2017/001/R

PROCEDURE FOR CHANGES NOT REQUIRING PRIOR APPROVAL

- (a) For changes not requiring prior approval, the procedure should define how the service provider should notify and manage the change.
- (b) The service provider should inform the competent authority of any changes to nominated persons specified in [ATM/ANS.OR.B.020\(b\)](#) and [ATS.OR.200\(1\)\(iii\)](#), as applicable.

GM1 ATM/ANS.OR.A.040(b) Changes — general

ED Decision 2017/001/R

PROCEDURE FOR CHANGES NOT REQUIRING PRIOR APPROVAL

The procedure agreed by the service provider and the competent authority may also include the process for the reaction by the service provider to an unplanned change that may arise with the need for urgent action that would normally require prior approval of the competent authority. This is the case in which the service provider responds immediately to a safety problem as required in [ATM/ANS.OR.A.060](#) or when an emergency situation arises in which the service provider has to take immediate action to ensure the safety of the services.

ATM/ANS.OR.A.045 Changes to a functional system

Regulation (EU) 2017/373

- (a) A service provider planning a change to its functional system shall:
 - (1) notify the competent authority of the change;
 - (2) provide the competent authority, if requested, with any additional information that allows the competent authority to decide whether or not to review the argument for the change;
 - (3) inform other service providers and, where feasible, aviation undertakings affected by the planned change.

- (b) Having notified a change, the service provider shall inform the competent authority whenever the information provided in accordance with points (a)(1) and (2) is materially modified, and the relevant service providers and aviation undertakings whenever the information provided in accordance with point (a)(3) is materially modified.
- (c) A service provider shall only allow the parts of the change, for which the activities required by the procedures referred to in point [ATM/ANS.OR.B.010](#) have been completed, to enter into operational service.
- (d) If the change is subject to competent authority review in accordance with point [ATM/ANS.AR.C.035](#), the service provider shall only allow the parts of the change for which the competent authority has approved the argument to enter into operational service.
- (e) When a change affects other service providers and/or aviation undertakings, as identified in point (a)(3), the service provider and these other service providers, in coordination, shall determine:
 - (1) the dependencies with each other and, where feasible, with the affected aviation undertakings;
 - (2) the assumptions and risk mitigations that relate to more than one service provider or aviation undertaking.
- (f) Those service providers affected by the assumptions and risk mitigations referred to in point (e)(2) shall only use, in their argument for the change, agreed and aligned assumptions and risk mitigations with each other and, where feasible, with aviation undertakings.

AMC1 ATM/ANS.OR.A.045(a) Changes to a functional system

ED Decision 2017/001/R

NOTIFICATION

The notification of a change should not be considered complete until the following information is provided:

- (a) Name of the organisation notifying the change;
- (b) Unique identifier of change;
- (c) Version number of notification;
- (d) Title of the change;
- (e) Date of the submission of the original of this change notification;
- (f) Scheduled date of entry into service (even if only approximate);
- (g) Details of the change and its impact;
- (h) The list of the service providers and other aviation undertakings that are affected by the change as identified in [ATM/ANS.OR.A.045\(a\)\(3\)](#);
- (i) Entity in charge of the assurance case; and
- (j) Identity of a point of contact for communications with the competent authority.

GM1 ATM/ANS.OR.A.045(a) Changes to a functional system

ED Decision 2020/008/R

NOTIFICATION

- (a) A change should be notified as soon as the data defined in [AMC1 ATM/ANS.OR.A.045\(a\)](#) is available. The decision to review a change by the competent authority will be based, in most circumstances, on the notification data. Exceptions to this are cases where the competent authority is not familiar with the type of change or the complexity of the change requires a more thorough consideration.
- (b) Early and accurate notification facilitates the interactions between the provider and the competent authority and, thus, maximises the likelihood of introducing a change into service in due time and according to the service provider's initial schedule when the competent authority has decided to review an assurance case. Therefore, it is advisable that the change description identified in [AMC1 ATM/ANS.OR.A.045\(a\)](#) is completed as soon as possible and contains the following data:
- (1) Purpose of the change;
 - (2) Reasons for the change;
 - (3) Place of implementation;
 - (4) New/modified functions/services brought about by the change;
 - (5) High-level identification of the constituents of the functional system being changed, and what is modified in their functionality;
 - (6) Consequence of the change, i.e. the harmful effects of the hazards associated with the change — see (f) below and also the definition of 'risk' in Annex I (85).
- (c) The information provided in (b) may expedite the decision whether to review or not the proposed change, because it will allow the competent authority to gain complete knowledge of the change and, consequently, reduces the need for additional information. However, lack of some of this data should not delay the service provider's submission of the notification if to do so is likely to impede the introduction of the change. It should be noted that early interaction with its competent authority may help to complete the missing data.
- (d) The service provider should take into account that an early, clear and accurate change notification will assist the competent authority in making the decision to review or not the change and may prevent any inconvenience such as:
- (1) the competent authority having to ask for more information about the change in order to make its decision as required in [ATM/ANS.OR.A.045\(a\)\(2\)](#);
 - (2) the competent authority deciding to review a change unnecessarily because the notification is not clear enough; or
 - (3) the delay in the competent authority deciding whether to review a change, caused by the lack of information, having an impact on the proposed date of entry into service.
- (e) It is recognised that the understanding of the change will improve as the change process progresses and the interaction between the competent authority and the service provider strengthens. The service provider should notify the competent authority when the information provided in the previous notification is no longer valid or when the information previously missing becomes available. When additional information — other than the data specified in

[AMC1 ATM/ANS.OR.A.045\(a\)](#) — is supplied at the competent authority's request, then no update of the notification is required.

- (f) For air traffic services (ATS) providers, the consequences of the change specified in (b)(6), should be expressed in terms of the harmful effects of the change, i.e. the effects of the hazards associated with safety risks. These could be the result of a preliminary safety assessment, if available, or an early hazard analysis that concentrates on the service level effects. For service providers other than air traffic services providers, the consequences should be expressed in terms of what aspects of the performance of the service are impacted by the change.
- (g) The point of contact, as required in point (j) in [AMC1 ATM/ANS.OR.A.045\(a\)](#), provides a focal point for the competent authority to contact when seeking complementary information about the change when required. The aim is to improve communications between the provider and the competent authority about the change.
- (h) All notified changes should be unambiguously identified. The service provider and its competent authority should agree on a means of referencing so as to associate a unique identifier to a given notified change.
- (i) For routine changes, the notification to the competent authority may be done in a simpler manner, e.g. using forms less detailed than those specified in [AMC1 ATM/ANS.OR.A.045\(a\)](#) or notifying these changes collectively after being implemented at regular periods of times agreed between the provider and the competent authority. A service provider and its competent authority should coordinate so as to reach a common agreement on these types of changes that may not be reviewed by the competent authority. The list of such changes should be documented and formalised. The formalised agreement becomes part of the change management procedures identified in [ATM/ANS.OR.B.010](#). Consequently, the list will be reviewed by the competent authority as part of the audits it performs that are described in [ATM/ANS.AR.C.010\(a\)](#). The relevant audit activity is detailed in [AMC1 ATM/ANS.AR.C.010\(a\)\(a\)\(2\)](#).

GM2 ATM/ANS.OR.A.045(a) Changes to a functional system

ED Decision 2019/022/R

NOTIFICATION — SOFTWARE CRITICALITY

Depending on the complexity of the change to the functional system and the criticality of the software, the depth of the evaluation may vary. The service provider should coordinate as soon as possible with the competent authority in order to define a software oversight strategy as part of the change review activities, if a decision for change review is taken.

AMC1 ATM/ANS.OR.A.045(a)(3) Changes to a functional system

ED Decision 2017/001/R

NOTIFICATION TO USERS OF THE SERVICE

Having notified a change, the service provider should:

- (a) individually inform all known service providers potentially affected by the notified change; and
- (b) inform all aviation undertakings potentially affected by the change either individually or via a representative body of aviation undertakings or by publishing details of the planned change in a dedicated publication of the service provider or aeronautical information publications such as an aeronautical information circular (AIC).

GM1 ATM/ANS.OR.A.045(a)(3) Changes to a functional system

ED Decision 2017/001/R

DEDICATED PUBLICATION FOR PROPOSED CHANGES

The final users of services potentially affected by a change to a functional system may not be known by the service provider proposing the change. However, this should not prevent the service provider from using other means for notification than direct communication with the interested parties. In that case, the changes may be published in a dedicated website where the users of the service can periodically check for current proposed changes to the functional system that may affect them.

AMC1 ATM/ANS.OR.A.045(b) Changes to a functional system

ED Decision 2017/001/R

MODIFICATION OF A NOTIFIED CHANGE

- (a) The service provider should inform the competent authority that was initially notified about any update in the notification data when the information provided in a previous notification about the same change is no longer valid or when information previously missing becomes available. The other service providers and aviation undertakings should also be informed, when they are affected by the new data.
- (b) The cancellation of a previously notified change should be considered as a modification of a notified change. Therefore, the service provider should inform about this update the competent authority, and inform other service providers and aviation undertakings that were initially informed about the change.

AMC1 ATM/ANS.OR.A.045(c); (d) Changes to a functional system

ED Decision 2017/001/R

ENTRY INTO OPERATIONAL SERVICE OF A CHANGE SELECTED FOR REVIEW

The service provider should not start the implementation of any part of the change that has the potential to affect the safety of the services currently being provided until a valid safety (support) assessment for that part of the change exists and, if the change is subject to competent authority review, it has been approved by the competent authority.

GM1 ATM/ANS.OR.A.045(c); (d) Changes to a functional system

ED Decision 2017/001/R

TRANSITION INTO SERVICE

- (a) No matter whether the competent authority has decided to review the notified change or not, the service provider should not start the implementation of any part of the change that has the potential to affect the safety of any of the services it provides, e.g. the functions performed or the performance of the services, until it has produced a valid argument in accordance with [ATS.OR.205\(a\)\(2\)](#) or/and [ATM/ANS.OR.C.005\(a\)\(2\)](#), as appropriate.
- (b) Implementation of the change, which means the creation and installation of the items to be used in the changed operational system may or may not affect the performance of the current services offered by the service provider. For example, much of the implementation of equipment and procedures can be performed 'off line', i.e. in development facilities that do not interact with the operational services and installation may be started, provided the items are not connected to the operational system and their presence in the operational environment

does not affect the current services. However, these items must not be introduced into the operational system, i.e. they must not affect the behaviour of any operational service, until a valid assurance case exists and, if the change is subject to competent authority review, before the competent authority has approved the change.

- (c) The installation of an artefact may have an impact on services other than the service being changed. This can happen where the installation involves disrupting these other services, e.g. aerodrome operations may be disrupted because runways or taxiways are being used by constructor's vehicles or are being interfered with. In this case, the scope of the change includes these other services (please refer to [ATM/ANS.OR.C.005\(a\)\(1\)\(iii\) & \(iv\)](#) or [ATS.OR.205\(a\)\(1\)\(iii\) & \(iv\)](#), as appropriate) and the assessment of the change includes the effects installation may have on them, including where the installation does not go according to plan.

AMC1 ATM/ANS.OR.A.045(e) Changes to the functional system

ED Decision 2017/001/R

CHANGES AFFECTING MULTIPLE SERVICE PROVIDERS — OVERARCHING SAFETY ARGUMENT

A change as defined in [ATM/ANS.OR.A.045\(e\)](#) may involve more than one service provider changing their functional systems. In this case, the change will consist of a set of changes to different ATM/ANS functional systems or their context. However, no matter how many individual changes to service providers' functional systems are part of the change, they should be coordinated. An overarching safety argument, coherent with the arguments of the individual changes, that claims the complete change is safe should be provided.

GM1 ATM/ANS.OR.A.045(e) Changes to the functional system

ED Decision 2017/001/R

CHANGES AFFECTING MULTIPLE SERVICE PROVIDERS AND AVIATION UNDERTAKINGS — GENERAL

- (a) Any change proposed by a service provider as defined in [ATM/ANS.OR.A.045\(a\)](#) affects other service providers and/or aviation undertakings when:
- (1) the proposed change may alter the service delivered to other service providers and aviation undertakings as users of that service; or
 - (2) the proposed change may alter the operational context in which the services of other service providers and aviation undertakings are delivered or in which the aviation undertakings are operating.
- (b) The changes referred to in [ATM/ANS.OR.A.045\(e\)](#) could be considered 'multi-actor changes' and are those changes that require coordination between the service provider(s) proposing the change and any service providers and aviation undertakings affected by the change(s) due to the presence of dependencies between the service providers that planned the change and other affected service providers and/or other aviation undertakings. This coordination is essential to ensure a correct safety (support) assessment when there are dependencies.
- (c) A single-actor change is one that is limited to those cases where a change to a service provider's functional system alters neither the service nor the operational context of other service providers and aviation undertakings.

GM2 ATM/ANS.OR.A.045(e) Changes to the functional system

ED Decision 2017/001/R

AFFECTED STAKEHOLDERS — SERVICE PROVIDERS AND AVIATION UNDERTAKINGS

- (a) 'Other service providers' mentioned in [ATM/ANS.OR.A.045\(e\)](#) refers to European service providers other than the service provider proposing the change, that are regulated in accordance with [Regulation \(EC\) No 216/2008](#) and its implementing rules;
- (b) Aviation undertakings affected by the change included in [ATM/ANS.OR.A.045\(e\)](#) can be understood as the stakeholders and professional associations with dependencies with the changed service, and may include the following:
 - (1) service providers that do not fall under the remit of Regulation (EC) No 216/2008 and its implementing rules, e.g. non-European service providers;
 - (2) aerodrome operators;
 - (3) aircraft operators;
 - (4) airframe and equipment manufacturers;
 - (5) maintenance organisations;
 - (6) regulatory bodies, e.g. European Commission, EASA, national aviation authorities (NAAs); and
 - (7) other bodies not regulated by [Regulation \(EC\) No 216/2008](#) and its implementing rules, e.g. power suppliers or military authorities.

GM3 ATM/ANS.OR.A.045(e) Changes to the functional system

ED Decision 2017/001/R

CHANGE AFFECTING MULTIPLE SERVICE PROVIDERS AND AVIATION UNDERTAKINGS — COORDINATION

- (a) [ATM/ANS.OR.A.045\(e\)](#) applies to all the affected service providers involved in the change, and, therefore, they should coordinate dependencies as well as shared assumptions and shared risk mitigations. They should only use the agreed and aligned assumptions and mitigations that are related to more than one service provider or aviation undertaking in their safety or safety support cases, as required by [ATM/ANS.OR.A.045\(f\)](#).
- (b) Assumptions and risk mitigations used during the assessment of the change that are not shared by the affected service providers, can be handled independently by each service provider, and do not need agreement.
- (c) This coordination means that the affected service providers:
 - (1) have jointly identified the scope of their responsibilities with regard to the change, and in particular their safety responsibilities, e.g. what part of the change will be covered in whose safety (support) assessment case;
 - (2) have jointly identified the dependencies;
 - (3) have jointly identified the hazards associated with the change in the common context;
 - (4) have mutually agreed on the assumptions for the change that jointly relate to them; and
 - (5) have mutually agreed on the mitigations for risks that require joint implementation.
- (d) Service providers would need to achieve a common understanding about:

- (1) consequences in the shared operational context; and
 - (2) chains of causes/consequences.
- (e) Service providers would jointly need to identify their dependencies to be able to assess the change to their functional systems.
- (f) Where necessary in relation to the dependences identified in accordance with [GM1 ATM/ANS.OR.A.045\(e\)\(1\)](#), the service providers may perform together:
- (1) identification of hazards/effects;
 - (2) assessment of risks;
 - (3) evaluation of risks;
 - (4) planning and assessment of risk mitigations; and
 - (5) verification.
- (g) The level of interaction and coordination between service providers and aviation undertakings will vary depending on the particular needs of the change at hand.

GM4 ATM/ANS.OR.A.045(e) Changes to a functional system

ED Decision 2017/001/R

COORDINATION WITH AFFECTED AVIATION UNDERTAKINGS

- (a) The aviation undertakings are the entities, persons or organisations as defined in point 34 of Annex I to [Regulation \(EU\) 2017/373](#) and thus, [ATM/ANS.OR.A.045\(e\)](#) does not apply to them. However, any service provider affected by a change should seek the participation of aviation undertakings when assumptions and risk mitigations used in the safety (support) assessment are shared with those aviation undertakings.
- (b) When the number of aviation undertakings affected by the change is large, the service providers may not need to involve every individual stakeholder. If a body can represent the views of a group of affected aviation undertakings, it may suffice to involve that representative body to obtain the supporting evidence to move forward with the assessment of the change.

GM1 ATM/ANS.OR.A.045(e)(2) Changes to a functional system

ED Decision 2017/001/R

CHANGE AFFECTING MULTIPLE SERVICE PROVIDERS AND AVIATION UNDERTAKINGS — ASSUMPTIONS AND RISK MITIGATIONS

In order to satisfy [ATM/ANS.OR.A.045\(e\)\(2\)](#), the affected service providers coordination will identify those assumptions and risk mitigations that relate to:

- (a) more than one service provider;
- (b) a service provider and one or more aviation undertakings; or
- (c) multiple service providers and aviation undertakings.

GM1 ATM/ANS.OR.A.045(f) Changes to a functional system

ED Decision 2017/001/R

LACK OF COORDINATION

- (a) If an aviation undertaking decides not to cooperate, the service provider, who has identified dependencies with the aviation undertaking, in accordance with [ATM/ANS.OR.A.045\(e\)\(1\)](#), needs to consider the impact of having the assumptions and risk mitigations not agreed with that aviation undertaking. It should propose a way forward by doing one or more of the following:
- (1) making the assumptions themselves and providing evidence that supports them;
 - (2) adding additional mitigating measures so that the change remains acceptably safe;
 - (3) modifying the scope of the change, or even reconsidering and cancelling the change.
- (b) The service provider affected by a lack of cooperation with an aviation undertaking may wish to inform its competent authority about those aviation undertakings that are not participating and its form of non-participation, in order to seek the assistance of the competent authority in trying to persuade the aviation undertaking to participate.

ATM/ANS.OR.A.050 Facilitation and cooperation

Regulation (EU) 2017/373

A service provider shall facilitate inspections and audits by the competent authority or by a qualified entity acting on its behalf and it shall cooperate as necessary for the efficient and effective exercise of the powers of the competent authorities referred to in [Article 5](#).

GM1 ATM/ANS.OR.A.050 Facilitation and cooperation

ED Decision 2019/022/R

AUDITS — SOFTWARE ASSURANCE PROCESSES BY THE COMPETENT AUTHORITY

- (a) The assessment of an effective application of the documented software assurance processes may necessitate a technical evaluation of the evidence and arguments produced for the software assurance by the competent authority when reviewing a notified change. In this context, the service provider should ensure access to the configuration management system for the competent authority, which may need to verify:
- (1) the consistency of all the evidence; and
 - (2) the fact that all the evidence is derived from a known version of the software (i.e. all evidence and arguments are actually available and can be traced without ambiguity to the executable version).
- (b) The service provider should:
- (1) anticipate the possibility for on-site audits or inspections by the competent authority; and
 - (2) when evidence and arguments are developed by contracted organisations, include the corresponding rights of the competent authority to assess said organisations during onsite audits or inspections.

ATM/ANS.OR.A.055 Findings and corrective actions

Regulation (EU) 2017/373

After receipt of notification of findings from the competent authority, the service provider shall:

- (a) identify the root cause of the non-compliance;
- (b) define a corrective action plan that meets the approval by the competent authority;
- (c) demonstrate corrective action implementation to the satisfaction of the competent authority within the time period proposed by the service provider and agreed with that authority, as defined in point [ATM/ANS.AR.C.050\(e\)](#).

GM1 ATM/ANS.OR.A.055 Findings and corrective actions

ED Decision 2017/001/R

GENERAL

- (a) Corrective action is the action taken to eliminate or mitigate the root cause(s) and prevent the recurrence of existing detected non-compliance or other undesirable condition or situation.
- (b) The proper determination of the root cause is crucial for defining effective corrective actions.

AMC1 ATM/ANS.OR.A.055(b) Findings and corrective actions

ED Decision 2017/001/R

GENERAL

The corrective action plan defined by the service provider should address the effects of the non-conformity and its root cause.

AMC1 ATM/ANS.OR.A.055(c) Findings and corrective actions

ED Decision 2017/001/R

CORRECTIVE ACTION IMPLEMENTATION PERIOD — DAT PROVIDERS

In case of a Level 1 finding, the DAT provider should demonstrate corrective action to the satisfaction of the competent authority within a period of no more than 21 working days following receipt of written confirmation of the finding. At the end of this period and subject to the nature of the finding, the 21-working-day period may be extended and agreed by the competent authority when the safety issue is mitigated.

ATM/ANS.OR.A.060 Immediate reaction to a safety problem

Regulation (EU) 2017/373

A service provider shall implement any safety measures, including safety directives, mandated by the competent authority in accordance with point [ATM/ANS.AR.A.025\(c\)](#).

ATM/ANS.OR.A.065 Occurrence reporting

Regulation (EU) 2021/1338

- (a) As part of its management system, the ATM/ANS provider shall establish and maintain an occurrence-reporting system, including mandatory and voluntary reporting. ATM/ANS providers established in a Member State shall ensure that the system complies with the

requirements of Regulation (EU) No 376/2014 and Regulation (EU) 2018/1139, as well as with the delegated and implementing acts adopted on the basis of those regulations.

- (b) The ATM/ANS provider shall report to the competent authority and to any other organisation required to be informed by the Member State, where the ATM/ANS provider provides its services, any safety-related event or condition that endangers or, if not corrected or addressed, could endanger an aircraft, its occupants or any other person, and in particular any accident or serious incident.
- (c) Without prejudice to point (b), the ATM/ANS provider shall report to the competent authority and to the organisation responsible for the design and/or maintenance of the ATM/ANS systems and constituents, if different from the ATM/ANS provider, any malfunction, technical defect, exceedance of technical limitations, occurrence, or other irregular circumstance that has or may have endangered the safety of services and has not resulted in an accident or serious incident.
- (d) Without prejudice to Regulation (EU) No 376/2014 and the delegated and implementing acts adopted on the basis thereof, reports shall:
 - (1) be made as soon as practicable, but in any case within 72 hours after the ATM/ANS provider has become aware of the event or condition to which the report relates, unless exceptional circumstances prevent this;
 - (2) be made in a form and manner established by the competent authority;
 - (3) contain all pertinent information about the condition known to the ATM/ANS provider.
- (e) For ATM/ANS providers that are not established in a Member State, initial mandatory reports shall:
 - (1) appropriately safeguard the confidentiality of the identity of the reporter and of the persons mentioned in the report;
 - (2) be made as soon as practicable, but in any case within 72 hours after the ATM/ANS provider has become aware of the occurrence, unless exceptional circumstances prevent this;
 - (3) be made in a form and manner established by the competent authority;
 - (4) contain all pertinent information about the condition known to the ATM/ANS provider.
- (f) Without prejudice to Regulation (EU) No 376/2014 and its delegated and implementing acts, where relevant, a follow-up report providing details of actions the organisation intends to take to prevent similar occurrences in the future shall be made as soon as these actions have been identified; those follow-up reports shall:
 - (1) be sent to the relevant entities initially reported to in accordance with points (b) and (c); and
 - (2) be made in a form and manner established by the competent authority.

AMC1 ATM/ANS.OR.A.065 Occurrence reporting

ED Decision 2022/004/R

REPORTING RESPONSIBILITIES AND REPORTING PROCEDURES

- (a) The ATM/ANS provider should assign one or more suitably qualified persons that has or have clearly defined authority and responsibility to coordinate actions on occurrences and to initiate any necessary further investigation and follow-up activity.

- (b) If more than one person is assigned such responsibility, the ATM/ANS provider should identify a single person to act as the main focal point for ensuring a single reporting channel is established to the accountable manager. This should in particular apply to ATM/ANS providers that hold one or more additional organisation certificates within the scope of Regulation (EU) 2018/1139 and its delegated and implementing acts where the occurrence-reporting system is fully integrated with that required under the additional certificate(s) held.
- (c) The ATM/ANS provider should establish procedures to be used for reporting to the competent authority and to any other organisation required, which include as a minimum:
- (1) a description of the applicable requirements for reporting;
 - (2) the scope of reporting to other organisations, considering the service provider's interfaces with other organisations, including organisations contracted in accordance with point ATM/ANS.OR.B.015;
 - (3) a description of the reporting mechanism, including reporting forms, means and deadlines;
 - (4) safeguards to ensure the protection of the reporter's confidentiality and the protection of personal data;
 - (5) responsibilities of the organisation and personnel involved in the reporting; and
 - (6) a description of the mechanism and personnel responsibilities for identifying root causes, and the actions that may be needed to be taken to prevent similar occurrences in the future, as appropriate.

Such procedures should be included in the organisation's management system documentation.

AMC2 ATM/ANS.OR.A.065 Occurrence reporting

ED Decision 2022/004/R

MANDATORY REPORTING — GENERAL

- (a) For ATM/ANS providers that have their principal place of operation and, if any, their registered office located in a Member State, Commission Implementing Regulation (EU) 2015/1018 of 29 June 2015 lays down a list classifying occurrences in civil aviation to be mandatorily reported according to Regulation (EU) No 376/2014. This list should not be understood as being an exhaustive collection of all issues that may pose a significant risk to aviation safety and, therefore, reporting should not be limited to the items listed in that Regulation and the additional items referred to in point [ATM/ANS.OR.A.065\(c\)](#).
- (b) In addition to the reports referred to in point (a), ATM/ANS providers should report volcanic ash clouds, encountered by aircraft operators, of which they have become aware.

AMC3 ATM/ANS.OR.A.065 Occurrence reporting

ED Decision 2022/004/R

GENERAL

Where the ATM/ANS provider holds one or more additional organisation certificates within the scope of Regulation (EU) 2018/1139 and its delegated and implementing acts:

- (a) the ATM/ANS provider may establish an integrated occurrence-reporting system covering all certificate(s) held; and

- (b) single occurrence reports should only be provided if all the following conditions are met:
- (1) the report includes all relevant information from the perspective of the different organisation certificates held;
 - (2) the report addresses all relevant and specific mandatory data fields and clearly identifies all certificate holders for which the report is made;
 - (3) the competent authority for all certificates is the same and such single reporting was agreed with that competent authority.

AMC1 ATM/ANS.OR.A.065(c) Occurrence reporting

ED Decision 2022/004/R

REPORTING BETWEEN ORGANISATIONS

- (a) The reporting to the organisations defined in point [ATM/ANS.OR.A.065](#) does not affect the need to report to other organisations with which the ATM/ANS provider interfaces, and which might be involved in or be affected by the reported event (e.g. other service providers, including contracted parties in accordance with point [ATM/ANS.OR.B.015](#), involved in an occurrence, aerodrome operators, etc.).
- (b) Any ATM/ANS provider that reports to the organisation responsible for the design of the air traffic management (ATM)/air navigation services (ANS) systems and ATM/ANS constituents should actively support any investigations that may be initiated by that organisation. Support should be provided by a timely response to information requests and by making available affected system components or constituents, for the purpose of the investigation, subject to an agreement with the respective system component or constituent owners.
- (c) In addition to reporting to the organisation responsible for the design of the ATM/ANS systems and ATM/ANS constituents, if different from the ATM/ANS provider, the ATM/ANS provider may be required to report to the aerodrome operator, to other ATM/ANS providers or air operators.
- (d) To ensure effective reporting between organisations, it is important that:
- (1) an interface is established between the organisations to ensure that there is an effective and timely exchange of occurrence-related information; and
 - (2) any relevant safety issue is identified, and it is clearly established which party is responsible for taking further action, if required.

GM1 ATM/ANS.OR.A.065(c) Occurrence reporting

ED Decision 2022/004/R

SYSTEMS AND CONSTITUENTS

- (a) When determining which failures of systems and constituents are to be reported, a degree of practicality is required as it is not intended that every failure is reported. Only those that have or may have an impact on the safety of the provision of services are reported.
- (b) When nothing is defined in European Union or national legislation, the determination of the failures of systems and constituents that need to be reported is done by the service provider and needs to be approved by the competent authority. This determination can be done as a result of an assessment of the installations or changes to the systems and constituents.

- (c) The organisation responsible for the design of the systems and constituents may no longer exist or may no longer support the design. In this case, the service provider will have made arrangements to ensure that the safety of the systems and constituents can be assured by appropriate and practical means. In many cases, this means that the service provider has taken over the design responsibilities.
- (d) Within the application of [Regulation \(EC\) No 552/2004](#), the organisation responsible for the design of the constituent will be the entity that signs the Declaration of Conformity or Suitability for use. For systems and constituents which existed before the applicability date of Regulation (EC) No 552/2004, the service provider should identify the responsible organisation, otherwise the service provider should make appropriate arrangements.

AMC1 ATM/ANS.OR.A.065(e) Occurrence reporting

ED Decision 2022/004/R

ORGANISATIONS THAT REPORT TO THE AGENCY

- (a) Mandatory reports and, where possible, voluntary reports, should include the information below:
 - (1) when: UTC date;
 - (2) where: State/area of occurrence — location of occurrence;
 - (3) aircraft-related information: aircraft identification: State of registry, make–model–series, aircraft category, propulsion type, mass group, aircraft serial number, aircraft registration number, and call sign;
 - (4) aircraft operation and history of flight: operator, type of operation, last departure point, planned destination, flight phase;
 - (5) weather: relevant weather;
 - (6) where relevant, ANS-related information: ATM contribution, service(s) affected, ATS unit name;
 - (7) where relevant, aerodrome-related information: location indicator (ICAO airport code), location at the aerodrome; and
 - (8) information on aircraft damage or on injuries to persons: severity in terms of highest damage and injury level, number of injured persons, and type of injuries to them, on the ground and in the aircraft.
- (b) Where the organisation identifies an actual or potential aviation safety risk as a result of its analysis of occurrences or a group of occurrences reported to the Agency, it should:
 - (1) transmit the following information to the Agency within 30 days from the date of notification of the occurrence to the Agency:
 - (i) the preliminary results of the risk assessment performed; and
 - (ii) any preliminary mitigation action to be taken;
 - (2) where required, transmit the final results of the risk analysis to the Agency as soon as they are available and, in principle, no later than 3 months from the date of initial notification of the occurrence to the Agency.

- (c) The following list provides examples of what needs to be mandatorily reported in addition to those required by point [ATM/ANS.OR.A.065\(c\)](#). This list should not be understood as being an exhaustive collection of all the issues that may pose a significant risk to aviation safety and, therefore, reporting should not be limited to the items listed therein.

1. AIRCRAFT-RELATED OCCURRENCES

(1)	A collision or a near collision on the ground or in the air, between an aircraft and another aircraft, terrain or obstacle ¹ , including near-controlled flight into terrain (near CFIT)
(2)	Separation minima infringement ²
(3)	Inadequate separation ³
(4)	ACAS RAs
(5)	Wildlife strike, including bird strike
(6)	Taxiway or runway excursion
(7)	Actual or potential taxiway or runway incursion
(8)	Final approach and take-off area (FATO) incursion
(9)	Aircraft deviation from ATC clearance
(10)	Aircraft deviation from applicable ATM regulations: <ul style="list-style-type: none"> (a) aircraft deviation from applicable published ATM procedures (b) airspace infringement, including unauthorised penetration of airspace (c) deviation from aircraft ATM-related equipment carriage and operations, as mandated by the applicable regulations
(11)	Occurrences related to call-sign confusion

2. DEGRADATION OR A TOTAL LOSS OF SERVICES OR FUNCTIONS

(1)	Inability to provide ATM services or to execute ATM functions: <ul style="list-style-type: none"> (a) inability to provide ATS or to execute ATS functions (b) inability to provide airspace management services or to execute airspace management functions (c) inability to provide air traffic flow management and capacity services or to execute air traffic flow management and capacity functions
(2)	Missing or significantly incorrect, corrupted, inadequate or misleading information from any support service ⁴ , including relating to poor runway surface conditions
(3)	Failure of communication service
(4)	Failure of surveillance service
(5)	Failure of data processing and distribution function or service
(6)	Failure of navigation service
(7)	Failure of the ATM system security which had or could have a direct negative impact on the safe provision of the service
(8)	Significant ATS sector/position overload leading to a potential deterioration in the provision of the service
(9)	Incorrect receipt or incorrect interpretation of significant communications, including lack of understanding of the language used, when this had or could have a direct negative impact on the safe provision of the service
(10)	Prolonged loss of communication with an aircraft or with other ATS units

3. OTHER OCCURRENCES

(1)	Declaration of an emergency ('Mayday' or 'PAN' call)
(2)	Significant external interference with ANS (for example, radio broadcast stations transmitting in the FM band, interfering with the instrument landing system (ILS), VHF omni-directional radio range (VOR) and communication)
(3)	Interference with an aircraft, an ATS unit or a radio communication transmission including by firearms, fireworks, flying kites, laser illumination, high-powered lights lasers, remotely piloted aircraft systems, model aircraft, or by similar means

(4)	Fuel dumping
(5)	Bomb threat or hijack
(6)	Fatigue impacting or potentially impacting on the ability of related staff to perform safely their air navigation or air traffic duties
(7)	Any occurrence where the human performance has directly contributed to or could have contributed to an accident or a serious incident

- (1) Obstacle includes vehicles.
- (2) This refers to a situation in which prescribed separation minima were not maintained between aircraft or between aircraft and airspace to which separation minima are prescribed.
- (3) In the absence of prescribed separation minima, a situation in which aircraft were perceived to pass too close to each other for pilots to ensure safe separation.
- (4) For example, air traffic service (ATS), automatic terminal information service (ATIS), meteorological services, navigation databases, aeronautical information service (AIS).

ATM/ANS.OR.A.070 Contingency plans

Regulation (EU) 2017/373

A service provider shall have in place contingency plans for all the services it provides in the case of events which result in significant degradation or interruption of its operations.

GM1 ATM/ANS.OR.A.070 Contingency plans

ED Decision 2017/001/R

GENERAL

The contingency plan may include the definition of the measures, the coordination with other actors (i.e. the State, the competent authorities, possibly the other service providers, the insurance companies, aerodrome operators, as applicable) and alternative services needed in case of degradation or interruption of the services, while the applicability of emergency response planning may be attributable to or affected by an aviation safety occurrence.

ATM/ANS.OR.A.075 Open and transparent provision of services

Regulation (EU) 2017/373

- (a) A service provider shall provide its services in an open and transparent manner. It shall publish the conditions of access to its services and changes thereto and establish a consultation process with the users of its services on a regular basis or as needed for specific changes in service provision, either individually or collectively.
- (b) A service provider shall not discriminate on grounds of nationality or other characteristic of the user or the class of users of its services in a manner that is contrary to Union law.

AMC1 ATM/ANS.OR.A.075(a) Open and transparent provision of services

ED Decision 2017/001/R

GENERAL — PROVIDERS OF AIR NAVIGATION SERVICES AND AIR TRAFFIC FLOW MANAGEMENT

Providers of air navigation services and air traffic flow management should consult with the users of their services at least once a year.

ATM/ANS.OR.A.080 Provision of aeronautical data

Commission Implementing Regulation (EU) 2020/469

- (a) A service provider shall ensure that aeronautical data related to its services is provided in due time to the AIS provider.
- (b) When aeronautical data related to its services is published, the service provider shall:
 - (1) monitor the data;
 - (2) notify the AIS provider of any changes necessary to ensure that the data is correct and complete;
 - (3) notify the AIS provider when the data is incorrect or inappropriate.

ATM/ANS.OR.A.085 Aeronautical data quality management

Regulation (EU) 2020/469

When originating, processing or transmitting data to the AIS provider, the service provider shall:

- (a) ensure that aeronautical data referred to in Appendix 1 conform to the specifications of the aeronautical data catalogue;
- (b) ensure that the following data quality requirements are met:
 - (1) the accuracy of aeronautical data is as specified in the aeronautical data catalogue;
 - (2) the integrity of aeronautical data is maintained;
 - (3) based on the integrity classification specified in the aeronautical data catalogue, procedures are put in place so that:
 - (i) for routine data, corruption is avoided throughout the processing of the data;
 - (ii) for essential data, corruption does not occur at any stage of the entire process and additional processes are included, as needed, to address potential risks in the overall system architecture to further assure data integrity at this level;
 - (iii) for critical data, corruption does not occur at any stage of the entire process and additional integrity assurance processes are included to fully mitigate the effects of faults identified as potential data integrity risks by thorough analysis of the overall system architecture;
 - (4) the resolution of aeronautical data is commensurate with the actual data accuracy;
 - (5) the traceability of aeronautical data is ensured;
 - (6) the timeliness of the aeronautical data is ensured, including any limits on the effective period of the data;
 - (7) the completeness of the aeronautical data is ensured;
 - (8) the delivered data meet the specified format requirements;
- (c) with regard to data origination, establish specific formal arrangements with the party originating data that contain instructions for data creation, modification or deletion, which include as a minimum:
 - (1) an unambiguous description of the aeronautical data to be created, modified or deleted;
 - (2) the entity to which the aeronautical data is to be provided;

- (3) the date and time by which the aeronautical data is to be provided;
- (4) the format of the data origination report to be used;
- (5) the format of the aeronautical data to be transmitted;
- (6) the requirement to identify any limitation on the use of the data;
- (d) ensure that data validation and verification techniques are employed to ensure that the aeronautical data meets the associated data quality requirements and in addition:
 - (1) the verification shall ensure that aeronautical data is received without corruption and that corruption does not occur at any stage of the entire aeronautical data process;
 - (2) aeronautical data and aeronautical information entered manually shall be subject to independent verification to detect any errors that may have been introduced;
 - (3) when using aeronautical data to derive or calculate new aeronautical data, the initial data shall be verified and validated, except when provided by an authoritative source;
- (e) transmit aeronautical data by electronic means;
- (f) establish formal arrangements with:
 - (1) all parties transmitting data to them;
 - (2) other service providers or aerodrome operators when exchanging aeronautical data and aeronautical information;
- (g) ensure that the information listed in point [AIS.TR.505\(a\)](#) is provided in due time to the AIS provider;
- (h) collect and transmit metadata which include as a minimum:
 - (1) the identification of the organisations or entities performing any action of originating, transmitting or manipulating the aeronautical data;
 - (2) the action performed;
 - (3) the date and time the action was performed;
- (i) ensure that tools and software used to support or automate aeronautical data and aeronautical information processes perform their functions without adversely impacting the quality of aeronautical data and aeronautical information;
- (j) ensure that digital data error detection techniques are used during the transmission or storage of aeronautical data, or both, in order to support the applicable data integrity levels;
- (k) ensure that the transfer of aeronautical data is subject to a suitable authentication process such that recipients are able to confirm that the data has been transmitted by an authorised source;
- (l) ensure that errors identified during data origination and after data delivery are addressed, corrected or resolved and that priority is given to managing errors in critical and essential aeronautical data.

GM1 ATM/ANS.OR.085 Aeronautical data quality management

ED Decision 2020/008/R

URGENT DISTRIBUTION OF AERONAUTICAL INFORMATION

The obligation to comply with the relevant provisions of ATM/ANS.OR.085 should not inhibit the urgent distribution of aeronautical information necessary to ensure the safety of flight. It is recognised

that in this case it is not always possible to comply with all the relevant provisions. However, it is also not possible to determine a priori all cases where this exception may apply; hence, this shall be dependent on a case-by-case individual assessment made by competent staff.

GM1 ATM/ANS.OR.A.085(a) Aeronautical data quality management

ED Decision 2020/008/R

AERONAUTICAL DATA CATALOGUE

The aeronautical data catalogue presents the scope of data that can be collected and maintained by the AIS providers and provides a common terminology that can be used by data originators and service providers.

GM1 ATM/ANS.OR.A.085(b) Aeronautical data quality management

ED Decision 2020/008/R

GENERAL

Minimum requirements for the processing of aeronautical data may be found in EUROCAE ED-76A, 'Standards for Processing Aeronautical Data', June 2015, which aims to assist aeronautical data chain actors.

GM1 ATM/ANS.OR.A.085(b)(4) Aeronautical data quality management

ED Decision 2020/008/R

RESOLUTION

- (a) Stating that resolution needs to be commensurate with the actual accuracy means that digital data needs to have sufficient resolution to maintain accuracy. Typically, if an accuracy of .1 unit is needed, then a resolution of 0.01 or .001 units would enable a data chain to preserve the accuracy without issue. A finer resolution could be misleading as one could assume that it supports a finer accuracy. This factor range of 10 to 100 between accuracy and resolution is applicable regardless of the units of measurements used.
- (b) The resolution should be enough to capture the accuracy of the data.

GM1 ATM/ANS.OR.A.085(b)(5) Aeronautical data quality management

ED Decision 2020/008/R

TRACEABILITY

Traceability is supported by maintaining the metadata.

AMC1 ATM/ANS.OR.A.085(b)(8) Aeronautical data quality management

ED Decision 2020/008/R

FORMAT

The format requirements should be specified in the formal arrangements.

AMC1 ATM/ANS.OR.A.085(d) Aeronautical data quality management

ED Decision 2020/008/R

VALIDATION AND VERIFICATION

- (a) The processes implemented to carry out validation and verification should define the means used to:
 - (a) verify received data and confirm that the data has been received without corruption;
 - (b) preserve data quality and ensure that stored data is protected from corruption; and
 - (c) confirm that originated data has not been corrupted prior to being stored.
- (b) Those processes should define the:
 - (1) actions to be taken when data fails a verification or validation check; and
 - (2) tools required for the verification and validation process.

GM1 ATM/ANS.OR.A.085(d) Aeronautical data quality management

ED Decision 2020/008/R

VALIDATION AND VERIFICATION — GENERAL

- (a) Validation
 - (1) Validation is the activity where a data element is checked as having a value that is fully applicable to the identity ascribed to the data element, or where a set of data elements are checked as being acceptable for their intended use.
 - (2) The application of validation techniques considers the entire aeronautical data chain. This includes the validation performed by prior data chain participants and any requirements levied on the data supplier.
 - (3) Examples of validation techniques
 - (i) Validation by application

One method of validation is to apply data under test conditions. In certain cases, this may not be practical. Validation by application is considered to be the most effective form of validation. For example, flight inspection of final approach segment data prior to publication can be used to ensure that the published data is acceptable.
 - (ii) Logical consistency

Logical consistency validates by comparing two different data sets or elements and identifying inconsistencies between values based on operative rules (e.g. business rules).

(iii) Semantic consistency

Semantic consistency validates by comparing data to an expected value or range of values for the data characteristics.

(iv) Validation by sampling

Validation by sampling evaluates a representative sample of data and applies statistical analysis to determine the confidence in the data quality.

(b) Verification

(1) Verification is a process for checking the integrity of a data element whereby the data element is compared to another source, either from a different process or from a different point in the same process. While verification cannot ensure that the data is correct, it can be effective to ensure that the data has not been corrupted by the data process.

(2) The application of verification techniques considers only the portion of the aeronautical data chain controlled by the organisation. Yet, verification techniques may be applied at multiple phases of the data processing chain.

(3) Examples of verification techniques

(i) Feedback

Feedback testing is the comparison between the output and input state of a data set.

(ii) Independent redundancy

Independent redundancy testing involves processing the same data through two or more independent processes and comparing the data output of each process.

(iii) Update comparison

Updated data can be compared to its previous version. This comparison can identify all data elements that have changed. The list of changed elements can then be compared to a similar list generated by the supplier. A problem can be detected if an element is identified as changed on one list and not on the other.

GM2 ATM/ANS.OR.A.085(d) Aeronautical data quality management

ED Decision 2020/008/R

VALIDATION AND VERIFICATION TECHNIQUES

Validation and verification techniques are employed throughout the data processing chain to ensure that the data meets the associated DQRs. More explanatory material may be found in Appendix C (Guidance on compliance with data processing requirements) to EUROCAE ED-76A 'Standards for Processing Aeronautical Data'.

GM1 ATM/ANS.OR.A.085(e) Aeronautical data quality management

ED Decision 2020/008/R

ELECTRONIC MEANS

The transmission of aeronautical data and aeronautical information may be done by various electronic means.

AMC1 ATM/ANS.OR.A.085(f) Aeronautical data quality management

ED Decision 2020/008/R

FORMAL ARRANGEMENTS

Formal arrangements should include the following minimum content:

- (a) the aeronautical data to be provided;
- (b) the data quality requirements (DQRs) for each data item supplied according to the aeronautical data catalogue;
- (c) the method(s) for demonstrating that the data provided conforms with the specified requirements;
- (d) the action to be taken in the event of discovery of a data error or inconsistency in any data provided;
- (e) the following minimum criteria for notification of data changes:
 - (1) criteria for determining the timeliness of data provision based on the operational or safety significance of the change;
 - (2) any prior notice of expected changes; and
 - (3) the means to be adopted for notification;
- (f) the party responsible for documenting data changes;
- (g) data exchange details such as format or format change processes;
- (h) any limitations on the use of data;
- (i) requirements for the production of data origination quality reports;
- (j) metadata to be provided; and
- (k) contingency requirements concerning the continuity of data provision

GM1 ATM/ANS.OR.A.085(f) Aeronautical data quality management

ED Decision 2020/008/R

FORMAL ARRANGEMENTS

ATM/ANS providers may use the predetermined template 'Data Provision Agreement' developed by EUROCONTROL (ADQ Formal Arrangement Template, version 1.1. issued on 22 February 2016.)

GM1 ATM/ANS.OR.A.085(i) Aeronautical data quality management

ED Decision 2020/008/R

SOFTWARE

- (a) A means by which the requirement in ATM/ANS.OR.A.085(i) can be met, is through the verification of software applied to a known executable version of the software in its target operating environment.
- (b) The verification of software is a process of ensuring that the software meets the requirements for the specified application or intended use of the aeronautical data and aeronautical information.
- (c) The verification of software is an evaluation of the output of an aeronautical data and/or aeronautical information software development process to ensure correctness and consistency with respect to the inputs and applicable software standards, rules and conventions used in that process.

GM2 ATM/ANS.OR.A.085(i) Aeronautical data quality management

ED Decision 2020/008/R

TOOLS

Tools can be qualified meeting point 2.4.5 Aeronautical Data Tool Qualification of EUROCAE ED-76A/RTCA DO-200B 'Standards for Processing Aeronautical Data', dated June 2015.

GM1 ATM/ANS.OR.A.085(j) Aeronautical data quality management

ED Decision 2020/008/R

DATA ERROR DETECTION TECHNIQUES

- (a) Digital error detection techniques can be used to detect errors during the transmission or storage of data. An example of a digital error detection technique is the use of cyclic redundancy checks (CRCs). Coding techniques can be effective regardless of the transmission media (e.g. computer disks, modem communication, or internet).
- (b) Transmission of data via electronic/digital means (e.g. file transfer protocol (FTP) sites, web downloads, or email) may be subject to malicious attack that can corrupt the integrity of data for its intended use. Provision of means to mitigate the intentional corruption of digitally transmitted data may already exist within the organisational construct and operating procedures of participating entities.
- (c) The objective of data security is to ensure that data is received from a known source and that there is no intentional corruption during processing and exchange of data.
- (d) Records should be maintained to show what data security provisions have been implemented.
- (e) Provisions supporting this objective may include:
 - (1) implementation of technical data security measures to provide authentication and prevent intentional corruption during exchange of data (e.g. secure hashes, secure transmissions, digital signatures); and
 - (2) implementation of organisational data security measures to protect processing resources and prevent intentional corruption during processing of data.

GM2 ATM/ANS.OR.A.085(j) Aeronautical data quality management

ED Decision 2020/008/R

DATA ERROR PROCESSING

More explanation and guidance may be found in Appendix C (Guidance on compliance with data processing requirements) to EUROCAE ED-76A.

GM1 ATM/ANS.OR.A.085(l) Aeronautical data quality management

ED Decision 2020/008/R

ERROR HANDLING

- (a) The term ‘error’ is understood as being defective, degraded, lost, misplaced or corrupted data elements, or data elements not meeting stated DQRs.
- (b) Guidance on how to detect, identify, report and address/resolve aeronautical data errors may be found in Appendix C (Guidance on compliance with data processing requirements) to EUROCAE ED-76A ‘Standards for Processing Aeronautical Data’.

ATM/ANS.OR.A.090 Common reference systems for air navigation

Commission Implementing Regulation (EU) 2020/469

For the purpose of air navigation, service providers shall use:

- (a) the World Geodetic System – 1984 (WGS-84) as the horizontal reference system;
- (b) the mean sea level (MSL) datum as the vertical reference system;
- (c) the Gregorian calendar and coordinated universal time (UTC) as the temporal reference systems.

GM1 ATM/ANS.OR.A.090(a) Common reference systems for air navigation

ED Decision 2020/008/R

HORIZONTAL REFERENCE SYSTEM — WGS-84

- (a) A reference system provides a definition of a coordinate system in terms of the position of an origin in space, the orientation of an orthogonal set of Cartesian axes, and a scale. A terrestrial reference system defines a spatial reference system in which positions of points anchored on the Earth’s solid surface have coordinates. Examples are WGS-84, ITRS/European Terrestrial Reference System (ETRS) and national reference systems.
- (b) WGS-84 defines, inter alia, a conventional terrestrial reference system, a reference frame and a reference ellipsoid. WGS-84 is currently the reference system ICAO requires for georeferencing aeronautical information.
- (c) Further explanation and guidance may be found in Annex B (Horizontal reference systems) to EUROCONTROL Specification for the Origination of Aeronautical Data, Volume 2: Guidance material (EUROCONTROL-SPEC-154, Edition 1.0 of 04/02/2013).

GM2 ATM/ANS.OR.A.090(a) Common reference systems for air navigation

ED Decision 2020/008/R

TEMPORARY NON-COMPLIANCE OF GEOGRAPHICAL COORDINATES

In those particular cases where geographical coordinates have been transformed into WGS-84 coordinates by mathematical means and whose accuracy of original field work does not meet the applicable requirements contained in the aeronautical data catalogue, they should be identified until the time when they can be compliant.

AMC1 ATM/ANS.OR.A.090(b) Common reference systems for air navigation

ED Decision 2020/008/R

VERTICAL REFERENCE SYSTEM

- (a) A service provider should use the Earth Gravitational Model — 1996 (EGM-96), as the global gravity model.
- (b) When a geoid model other than the EGM-96 model is used, a description of the model used, including the parameters required for height transformation between the model and EGM-96, should be provided in the aeronautical information publication (AIP).

GM1 ATM/ANS.OR.A.090(b) Common reference systems for air navigation

ED Decision 2020/008/R

MEAN SEA LEVEL

- (a) The geoid globally most closely approximates mean sea level (MSL). It is defined as the equipotential surface in the gravity field of the Earth which coincides with the undisturbed MSL extended continuously through the continents.
- (b) Gravity-related heights (elevations) are also referred to as 'orthometric heights', while distances of points above the ellipsoid are referred to as 'ellipsoidal heights'.
- (c) Global and local geoids differ in their origin: global geoids consider only the long- and middle-wave part of the Earth's gravity field, whilst local geoids also consider the short-wave part of the gravity field. Global geoids are used when consistent orthometric heights, over long distances (continent or earth surveying), are required. Currently, the world's best global geoid model is EGM 200846. It was determined using satellite tracking, gravity anomalies and satellite altimetry. Its accuracy is in the range of ± 0.05 m (oceans) and ± 0.5 m (on land). This accuracy is higher in flat regions than in topographically mountainous terrain, such as the Alps.
- (d) For local engineering applications and cadastre-surveying, global geoids are not as accurate as needed. For such applications, local geoid models are calculated. These can only be developed using local field measurements. They offer centimetre accuracy over several hundred kilometres, with a high resolution. Local geoids are not suitable for height comparison over large distances since they are based on different origins and reference heights (different equipotential levels).

GM2 ATM/ANS.OR.A.090(b) Common reference systems for air navigation

ED Decision 2020/008/R

VERTICAL REFERENCE SYSTEM

Further explanation and guidance may be found in Annex C (Vertical reference systems) to EUROCONTROL Specification for the Origination of Aeronautical Data, Volume 2 (EUROCONTROL-SPEC-154, Edition 1.0 of 04/02/2013).

GM1 ATM/ANS.OR.A.090(c) Common reference systems for air navigation

ED Decision 2020/008/R

TEMPORAL REFERENCE SYSTEM

- (a) A value in the time domain is a temporal position measured relative to a temporal reference system.
- (b) ISO Standard 8601 specifies the use of the Gregorian calendar and 24-hour local or UTC for information interchange, while ISO Standard 19108 prescribes the Gregorian calendar and UTC as the primary temporal reference system for use with geographic information.

SUBPART B — MANAGEMENT (ATM/ANS.OR.B)

ATM/ANS.OR.B.001 Technical and operational competence and capability

Regulation (EU) 2017/373

A service provider shall ensure that it is able to provide its services in a safe, efficient, continuous and sustainable manner, consistent with any foreseen level of overall demand for a given airspace. To this end, it shall maintain adequate technical and operational capacity and expertise.

GM1 ATM/ANS.OR.B.001 Technical and operational competence and capability

ED Decision 2017/001/R

TECHNICAL AND OPERATIONAL CAPACITY

Technical and operational capacity should include a sufficient number of personnel to perform its tasks and discharge its responsibilities.

ATM/ANS.OR.B.005 Management system

Regulation (EU) 2017/373

- (a) A service provider shall implement and maintain a management system that includes:
- (1) clearly defined lines of responsibility and accountability throughout its organisation, including a direct accountability of the accountable manager;
 - (2) a description of the overall philosophies and principles of the service provider with regard to safety, quality, and security of its services, collectively constituting a policy, signed by the accountable manager;
 - (3) the means to verify the performance of the service provider's organisation in light of the performance indicators and performance targets of the management system;
 - (4) a process to identify changes within the service provider's organisation and the context in which it operates, which may affect established processes, procedures and services and, where necessary, change the management system and/or the functional system to accommodate those changes;
 - (5) a process to review the management system, identify the causes of substandard performance of the management system, determine the implications of such substandard performance, and eliminate or mitigate such causes;
 - (6) a process to ensure that the personnel of the service provider are trained and competent to perform their duties in a safe, efficient, continuous and sustainable manner. In this context, the service provider shall establish policies for the recruitments and training of its personnel;
 - (7) a formal means for communication that ensures that all personnel of the service provider are fully aware of the management system that allows critical information to be conveyed and that makes it possible to explain why particular actions are taken and why procedures are introduced or changed.

- (b) A service provider shall document all management system key processes, including a process for making personnel aware of their responsibilities, and the procedure for the amendment of those processes.
- (c) A service provider shall establish a function to monitor compliance of its organisation with the applicable requirements and the adequacy of the procedures. Compliance monitoring shall include a feedback system of findings to the accountable manager to ensure effective implementation of corrective actions as necessary.
- (d) A service provider shall monitor the behaviour of its functional system and, where underperformance is identified, it shall establish its causes and eliminate them or, after having determined the implication of the underperformance, mitigate its effects.
- (e) The management system shall be proportionate to the size of the service provider and the complexity of its activities, taking into account the hazards and associated risks inherent in those activities.
- (f) Within its management system, the service provider shall establish formal interfaces with the relevant service providers and aviation undertakings in order to:
 - (1) ensure that the aviation safety hazards entailed by its activities are identified and evaluated, and the associated risks are managed and mitigated as appropriate;
 - (2) ensure that it provides its services in accordance with the requirements of this Regulation.
- (g) In the case that the service provider holds also an aerodrome operator certificate, it shall ensure that the management system covers all activities in the scope of its certificates.

GM1 ATM/ANS.OR.B.005 Management system

ED Decision 2020/008/R

DEFINITIONS AND CONCEPT OF MANAGEMENT SYSTEM

- (a) ISO 9000 series of standards define a management system as a 'set of interrelated or interacting elements to establish policy and objectives and to achieve those objectives'.
- (b) Another available definition of management system is the following: 'The structure, processes and resources needed to establish an organisation's policy and objectives and to achieve those objectives.'
- (c) Traditionally, separate management systems were developed to address issues such as safety, quality, environment, health and safety, finance, human resources, information technology and data protection. However, it is foreseen that more and more the services providers will establish integrated management systems following the harmonised set of requirements in this Regulation.
- (d) The Regulation does not require that the different management systems are integrated but it facilitates their integration.

GM2 ATM/ANS.OR.B.005 Management system

ED Decision 2017/001/R

RELATIONSHIP BETWEEN THE TYPE OF SERVICE AND SAFETY MANAGEMENT — QUALITY MANAGEMENT

- (a) All service providers are required to establish and maintain a management system. However, only an air traffic services provider can have managerial control over functions directly affecting

the safety of the flight (e.g. the ATCO to separate aircraft from each other). Hence, the management system requirements in [Annex III](#), which apply to all service providers, are more broadly associated with the quality of the service rather than the safety of the service. [Annex IV](#) (Part-ATS) has specific safety management requirements for the provision of air traffic services. Therefore, only the air traffic services provider (that providing air traffic control, alerting service, air traffic advisory service or flight information service) is required to have a safety management system and undertake safety assessment of changes to the functional system.

- (b) Service providers other than the air traffic services provider can still affect the safety of the flight through functions or services they provide, but this will always be influenced by the way in which the air traffic services provider or airspace user are using those functions or services. Therefore, service providers other than air traffic services providers have a management system which manages the performance of service (rather than the safe use of their services for flight navigation and the control which is beyond the managerial control of the service provider). This performance of the service refers to such properties of the service provided such as accuracy, reliability, integrity, availability, timeliness, etc.
- (c) It is quite likely that air traffic services providers have contractual arrangements in place with other service providers, whose services they use, specifying the required performance and requiring the service provider to inform, in a timely manner, the air traffic services provider of any impact on the performance of services supplied.
- (d) When the service provider other than an air traffic services provider provides services or functions directly to a flight (e.g. MET) without involving air traffic services, then the safe use of those services is the responsibility of the users of those services.
- (e) When the air traffic services provider also provides other services, it may choose to combine the necessary performance and safety management activities into an integrated management system covering all services.

AMC1 ATM/ANS.OR.B.005(a) Management system

ED Decision 2017/001/R

GENERAL

An ISO 9001 certificate, issued by an appropriately accredited organisation, addressing the quality management elements required in this Subpart should be considered a sufficient means of compliance for the service provider. In this case, the service provider should accept the disclosure of the documentation related to the certification to the competent authority upon the latter's request.

GM1 to AMC1 ATM/ANS.OR.B.005(a) Management system

ED Decision 2017/001/R

GENERAL

ISO 9001 Certificate(s) covers (cover) the quality management elements of the management system. Other elements required by this Regulation in reference to the management system that are not covered by the ISO 9001 certificate issued by an appropriately accredited organisation should be subject to oversight by the competent authority.

GM2 to AMC1 ATM/ANS.OR.B.005(a) Management system

ED Decision 2017/001/R

GENERAL — FOR ATS PROVIDERS

An ISO 9001 certificate may not give the presumption of compliance with the provisions of ATS.OR.200 'Safety management system'.

AMC2 ATM/ANS.OR.B.005(a) Management system

ED Decision 2017/001/R

GENERAL — TYPE 1 DAT PROVIDERS

An ISO 9001 or EN 9100 certificate issued by an appropriately accredited organisation addressing the quality management elements required in the respective Subparts should be considered a sufficient means of compliance for the Type 1 DAT provider. In this case, the Type 1 DAT provider should accept the disclosure of the documentation related to the certification to the competent authority upon its request.

GM1 to AMC2 ATM/ANS.OR.B.005(a) Management system

ED Decision 2017/001/R

GENERAL — TYPE 1 DAT PROVIDERS

ISO 9001/EN 9100 Certificate(s) covers (cover) the quality management elements of the management system. Other elements required by this Regulation in reference to the management system that are not covered by the ISO 9001/EN 9100 certificate issued by an appropriately accredited organisation should be subject to oversight by the competent authority.

AMC3 ATM/ANS.OR.B.005(a) Management system

ED Decision 2017/001/R

GENERAL — TYPE 2 DAT PROVIDERS

An EN 9100 certificate issued by an appropriately accredited organisation addressing the quality management elements required in the respective Subparts should be considered as a sufficient means of compliance for the Type 2 DAT provider. In this case, the Type 2 DAT provider should accept the disclosure of the documentation related to the certification to the competent authority upon its request.

GM1 to AMC3 ATM/ANS.OR.B.005(a) Management system

ED Decision 2017/001/R

EN 9100 CERTIFICATE — TYPE 2 DAT PROVIDERS

EN 9100 Certificate(s) covers (cover) the quality management elements of the management system. Other elements required by this Regulation in reference to the management system that are not covered by EN 9100 certificate issued by an appropriately accredited organisation should be subject to oversight by the competent authority.

AMC4 ATM/ANS.OR.B.005(a) Management system

ED Decision 2017/001/R

GENERAL — NON-COMPLEX SERVICE PROVIDERS

- (a) The policy should include a commitment to improve towards the highest standards, comply with all the applicable legal requirements, meet all the applicable standards, consider the best practices, and provide the appropriate resources.
- (b) The compliance monitoring task may be exercised by the accountable manager, provided that he or she has demonstrated having the related competence as defined in point (b)(4) of [GM1 ATM/ANS.OR.B.005\(c\)](#).
- (c) Risk management may be performed using hazard checklists or similar risk management tools or processes, which are integrated into the activities of the service provider.
- (d) A service provider should manage associated risks related to changes, as applicable. Management of changes should be a documented process to identify external and internal changes.
- (e) A service provider should identify persons who fulfil the role of managers and who are responsible with regard to safety, quality and security of its services, as applicable. These persons may be accountable managers or individuals with an operational role in the service provider.

GM1 ATM/ANS.OR.B.005(a)(1) Management system

ED Decision 2017/001/R

RESPONSIBILITIES AND ACCOUNTABILITIES

- (a) Senior management should ensure that responsibilities and accountabilities are defined and communicated within the service provider and documented within the management system. In the context of this rule, 'responsibilities' refers to obligations that can be delegated and 'accountabilities' refers to obligations that cannot be delegated.
- (b) The appointment of an accountable manager who is given the required authorities and responsibilities, requires that the individual has the necessary attributes to fulfil the role. The accountable manager may have more than one function in the organisation. Nonetheless, the accountable manager's role is to ensure that the management system is properly implemented and maintained through the allocation of resources and tasks.

AMC1 ATM/ANS.OR.B.005(a)(2) Management system

ED Decision 2017/001/R

POLICY

- (a) The policy should:
 - (1) be signed by the accountable manager;
 - (2) reflect organisational commitments regarding performance of its services and safety, where applicable, and its proactive and systematic management;
 - (3) include reporting principles; and
 - (4) include a commitment to:

- (i) improve towards the highest performance standards so as to support the achievement of the highest level of safety;
 - (ii) comply with all applicable legislation and requirements, meet all applicable standards and consider best practices;
 - (iii) continually improve the effectiveness of the management system;
 - (iv) provide appropriate resources;
 - (v) enforce the performance of the service required to support the achievement of the highest level of safety in the airspace where the service is provided as one primary responsibility of all managers; and
 - (vi) that the purpose of reporting is improvement and not to apportion blame to individuals.
- (b) Senior management should:
- (1) ensure that the policy:
 - (i) is appropriate to the purpose of service providers;
 - (ii) provides a framework for establishing and reviewing objectives in relation to the provision of the service;
 - (iii) is communicated and understood within the service provider; and
 - (iv) is reviewed for continuing suitability;
 - (2) continually promote the policy to all personnel and demonstrate their commitment to it;
 - (3) provide necessary and appropriate human and financial resources for its implementation; and
 - (4) establish objectives in relation to the provision of the services and performance standards.

GM1 ATM/ANS.OR.B.005(a)(2) Management system

ED Decision 2017/001/R

POLICY FOR AIR TRAFFIC SERVICES PROVIDERS VS POLICY FOR ALL OTHER SERVICE PROVIDERS

If a service provider does not undertake the provision of air traffic services, then the policy will be recognisable more as a quality policy that is concerned with the performance of the service and conformance to the service provision requirements supporting the achievement of the highest level of safety in the airspace where the service is provided. Should the service provider undertake the provision of air traffic services, then [ATS.OR.200](#) also applies and the policy will need to be expanded to include both the safety and the quality of the service.

GM2 ATM/ANS.OR.B.005(a)(2) Management system

ED Decision 2017/001/R

POLICY — NON-COMPLEX SERVICE PROVIDERS

The policy is the means whereby the service provider states its intention to maintain and, where practicable, improve performance levels in all their activities and to minimise their contribution to the risk of an aircraft accident as far as is reasonably practicable.

GM3 ATM/ANS.OR.B.005(a)(2) Management system

ED Decision 2017/001/R

SAFETY CULTURE

The policy should actively encourage effective safety reporting and, by defining the line between acceptable performance (often unintended errors) and unacceptable performance (such as negligence, recklessness, violations or sabotage), provide fair protection to reporters. A safety or just culture may not, however, preclude the ‘criminalisation of error’, which is legally, ethically and morally within the sovereign rights of any Member State, provided that European Union law and established international agreements are observed. A judicial investigation, and consequences of some form, may be expected following an accident or serious incident especially if a system failure resulted in lives lost or property damaged, even if no negligence or ill intent existed. A potential issue could, therefore, exist if voluntary hazard reports, which relate to latent deficiencies of a system or its performance, are treated in the same way as those concerning accident and serious incident investigations. The intent of protecting hazard reports should not challenge the legitimacy of a judicial investigation or demand undue immunity.

AMC1 ATM/ANS.OR.B.005(a)(3) Management system

ED Decision 2017/001/R

MANAGEMENT OF METEOROLOGICAL SERVICES PERFORMANCE

- (a) The management system of the meteorological service provider should provide users with assurance that the meteorological information supplied complies with the stated requirements in terms of geographical and spatial coverage, format and content, time and frequency of issuance and period of validity, as well as the accuracy of measurements, observations and forecasts.
- (b) When the management system indicates that the meteorological information to be supplied to users does not comply with the stated requirements, and automatic error correction procedures are not appropriate, such information should not be supplied to users unless it is validated with the originator.
- (c) In regard to the exchange of meteorological information for operational purposes, the management system should include verification and validation procedures and resources for monitoring adherence to the prescribed transmission schedules for individual messages and/or bulletins required to be exchanged as well as the times of their filing for transmission. The management system should be capable of detecting excessive transit times of messages and bulletins received.

AMC2 ATM/ANS.OR.B.005(a)(3) Management system

ED Decision 2017/001/R

SAFETY PERFORMANCE MONITORING AND MEASUREMENT — ATS PROVIDER

- (a) Safety performance monitoring and measurement should be the process by which the safety performance of the air traffic services providers is verified in comparison to the safety policy and the safety objectives established by the air traffic services provider.
- (b) This process should include:
 - (1) safety reporting;
 - (2) safety studies encompassing broad safety concerns;

- (3) safety reviews including trends reviews, which would be conducted during introduction and deployment of new technologies, change or implementation of procedures, or in situations of structural change in operations;
- (4) safety audits focusing on the integrity of the air traffic services provider's management system, and periodically assessing the status of safety risk controls; and
- (5) safety surveys, examining particular elements or procedures of a specific operation, such as problem areas or bottlenecks in daily operations, perceptions and opinions of operational personnel, and areas of dissent or confusion.

GM1 to AMC2 ATM/ANS.OR.B.005(a)(3) Management system

ED Decision 2017/001/R

SAFETY SURVEYS — COMPLEX AIR TRAFFIC SERVICES PROVIDER

- (a) An air traffic services provider should:
 - (1) initiate safety surveys and ensure that all safety-related activities within its scope are addressed periodically;
 - (2) appoint an appropriate survey leader and survey team whose expertise is in accordance with the particular requirements of the intended survey, taking due account of the desirability of including staff from outside areas where relevant, and being mindful of the opportunity such an activity provides for staff development and engagement;
 - (3) define an annual safety survey plan;
 - (4) take immediate remedial action as soon as any safety-related shortcomings are identified;
 - (5) ensure that the actions identified in the action plans are carried out within the specified timescales; and
 - (6) ensure that examples of lesson learning and good practice arising from safety surveys are disseminated and acted upon.
- (b) The survey leader should:
 - (1) carry out the survey;
 - (2) record the results;
 - (3) make recommendations; and
 - (4) agree actions with the relevant operational management.
- (c) The survey team should assist the survey leader in fulfilling their responsibilities as determined by the survey leader.
- (d) Safety surveys may be initiated by a number of means such as occurrence reports, safety performance, suggestions from members of staff, etc.
- (e) Safety surveys may be documented in a safety survey report which should also contain the specific actions that will be taken to address the recommendations. The actions should specify those responsible for completion and the target dates. The actions should be tracked to closure through an action plan. This action plan may be implemented as part of an existing locally or centrally managed action tracker.

(f) A typical safety survey report would require the following content:

- (1) Front sheet:
 - (i) reference number;
 - (ii) title;
 - (iii) survey period;
 - (iv) team members and team leader; and
 - (v) survey initiator;
- (2) Survey description:
 - (i) introduction;
 - (ii) objective;
 - (iii) scope;
 - (iv) record of results;
 - (v) conclusions; and
 - (vi) recommendations and actions.

(g) Survey leader

The survey leader should be adequately trained and competent for the subject of the survey. Where this is not possible, at least one member of the survey team should be competent in the subject of the survey.

(h) Survey team

It is advantageous for the survey team to be multi-disciplined and, where possible, be drawn from differing parts of the air traffic services provider's organisation.

GM1 ATM/ANS.OR.B.005(a)(3) Management system

ED Decision 2017/001/R

SAFETY PERFORMANCE MONITORING AND MEASUREMENT — ATS PROVIDER

- (a) The means to monitor performance is often through one or more leading or lagging indicators.
- (b) Indicators and performance measures provide feedback on what is happening so that the air traffic services provider can take appropriate actions to respond to changing circumstances. The indicators provide information on:
 - (1) what is happening around the air traffic services provider;
 - (2) how well the air traffic services provider is doing;
 - (3) what has happened so far; and
 - (4) warning of impending problems or dangers that the air traffic services provider may need to take action to avoid.
- (c) Although 'lagging' performance indicators that measure the final outcomes resulting from the air traffic services provider's activities are often considered as the most interesting, lagging indicators themselves may not provide enough information to guide the air traffic services provider's actions and ensure success.

- (d) By measuring the inputs to a process, leading performance indicators can complement the use of lagging indicators and compensate for some of their shortcomings. Leading indicators can be used to monitor the effectiveness of control systems and give advance warning of any developing weaknesses before problems occur. One purpose of leading performance indicators is, therefore, to show the condition of systems before accidents, incidents, harm, damage or failure occurs. In this way, they can help to control risks and prevent mishaps.
- (e) There is good evidence that when leading performance indicators are used correctly, they are effective in improving performance. However, there is also good evidence that they can be misused.
- (f) For leading performance indicators to play an effective role in the improvement process, there should be an association between the inputs that the leading performance indicators measure and the desired lagging outputs. There needs to be a reasonable belief that the actions taken to improve leading performance indicators will be followed by an improvement in the associated lagging output indicators.
- (g) The process for effective use of leading performance indicators can be summarised as:
- (1) Identify where there are potential weaknesses or opportunities for improvement;
 - (2) Identify what can be done to counter weaknesses or deliver improvement;
 - (3) Set performance standards for the actions identified;
 - (4) Monitor performance against the standards;
 - (5) Take corrective actions to improve performance; and
 - (6) Repeat the process by using the following continuous improvement model:

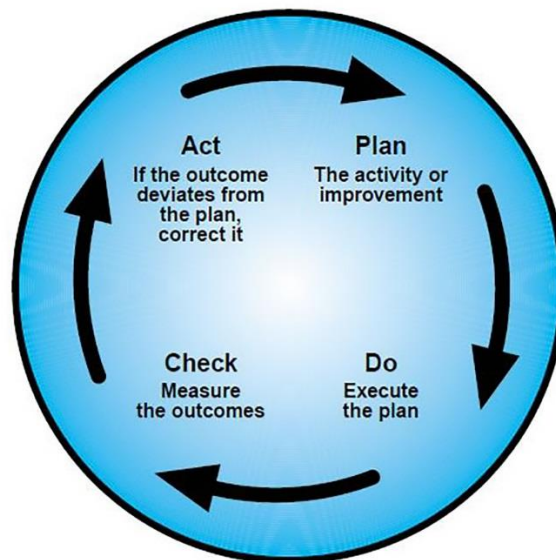

- (h) For any performance indicator to be effective, it is important that it is:
- (1) objective and easy to measure and collect;
 - (2) relevant to the air traffic services provider whose performance is being measured;
 - (3) capable of providing immediate and reliable indications of the level of performance;
 - (4) cost-efficient in terms of the equipment, personnel and additional technology required to gather the information;

- (5) understood and owned by the air traffic services provider whose performance is being measured;
- (6) related to activities considered to be important for future performance;
- (7) amenable to intervention/influence by the air traffic services provider whose performance is being measured;
- (8) related to something where there is scope to improve; and
- (9) a clear indication of a means to improve performance.

GM2 ATM/ANS.OR.B.005(a)(3) Management system

ED Decision 2017/001/R

PERFORMANCE MONITORING AND MEASUREMENT — SERVICE PROVIDER OTHER THAN AIR TRAFFIC SERVICES PROVIDER

A performance indicator (PI) is a type of performance measurement. An organisation may use PIs to evaluate its success, or to evaluate the success of a particular activity in which it is engaged. Sometimes success is defined in terms of making progress towards strategic goals, but often success is simply the repeated, periodic achievement of some level of operational goal (e.g. zero defects). Accordingly, choosing the right PIs relies upon a good understanding of what is important to the organisation. Since there is a need to understand well what is important, various techniques to assess the present state of the business, and its key activities, are associated with the selection of PIs. These assessments often lead to the identification of potential improvements, so performance indicators are routinely associated with 'performance improvement' initiatives. When PIs have performance targets associated with them, they are known as key performance indicators (KPIs).

GM1 ATM/ANS.OR.B.005(a)(4) Management system

ED Decision 2017/001/R

IDENTIFICATION OF CHANGES TO FUNCTIONAL SYSTEMS

This process is used by the service provider to correctly identify proposed changes. The changes dealt with in this GM are the proposed changes to the functional system. These can be triggered internally by changing circumstances that are related to the service provider of concern or externally by changing circumstances that are related to others or to the context in which the service operates, i.e. in situations where the service provider does not have managerial control over them. The triggers are called 'change drivers'.

- (a) Identification of internal circumstances
 - (1) The procedure to identify changes needs to be embedded in all parts of the organisation that can modify the functional system, i.e. the operational system used to support the services provided. Examples of proposed changes to the functional system as a response to changing circumstances under the control of the organisation, therefore, include:
 - (i) changes to the way the components of the functional system are used;
 - (ii) changes to equipment, either hardware or software;
 - (iii) changes to roles and responsibilities of operational personnel;
 - (iv) changes to operating procedures;

- (v) changes to system configuration, excluding changes during maintenance, repair and alternative operations that are already part of the accepted operational envelope;
 - (vi) changes that are necessary as a result of changing circumstances to the operational context under the managerial control of the provider that can impact the service, e.g. provision of service under new conditions;
 - (vii) changes that are necessary as a result of changing circumstances to the local physical (operational) environment of the functional system; and
 - (viii) changes to the working hours and/or shift patterns of key personnel which could impact on the safe delivery of services.
- (2) These changes are often identified by the service provider using business processes, which will be used to identify changes planned for the medium and long term. Such processes can include:
- (i) annual business plans;
 - (ii) strategic safety boards;
 - (iii) equipment replacement projects;
 - (iv) airspace reorganisation plans;
 - (v) introduction of new operational concepts, e.g. Free Flight;
 - (vi) accident and incident investigation reports; and
 - (vii) safety monitoring and safety surveys.
- (b) Identification of external circumstances
- The service provider should have processes in place to react appropriately to notifications received from those service providers that supply services to them. In addition, changes to the context that can impact on the service provided and are not under the managerial control of the service provider should be identified and treated as potential triggers. Furthermore, the service provider should negotiate contracts with unregulated service providers in accordance with [ATM/ANS.OR.B.015](#) 'Contracted activities' that place a responsibility on such organisations to inform them of planned changes to their services.

AMC1 ATM/ANS.OR.B.005(a)(5) Management system

ED Decision 2017/001/R

ASSESSMENT OF THE MANAGEMENT SYSTEM

- (a) Senior management should assess the service provider's management system, at planned intervals, to ensure its continuing suitability, adequacy and effectiveness.
- (b) The review should include assessing opportunities for improvement and the need for changes to the management system, including the policy and objectives.
- (c) Records from management assessments should be maintained.

AMC1 ATM/ANS.OR.B.005(a)(6) Management system

ED Decision 2017/001/R

TRAINING AND COMPETENCY

A service provider should:

- (a) determine the necessary competence for personnel performing activities supporting services provision;
- (b) where applicable, provide training or take other actions to achieve the necessary competence;
- (c) evaluate the effectiveness of the actions taken;
- (d) ensure that personnel are aware of the relevance and importance of their activities and how they contribute to the achievement of the objectives; and
- (e) maintain appropriate records of education, training, skills and experience.

GM1 ATM/ANS.OR.B.005(a)(6) Management system

ED Decision 2022/004/R

TRAINING AND COMPETENCIES— MET PROVIDERS

Information and guidance concerning the qualifications, competencies, education and training of meteorological personnel in aeronautical meteorology are given in the Technical Regulations (WMO No 49), Volume I *General Meteorological Standards and Recommended Practices, Part V Qualifications and Competencies of Personnel Involved in the Provision of Meteorological (Weather and Climate) and Hydrological Services*; Part VI *Education and Training of Meteorological Personnel, Appendix A Basic Instruction Packages*, WMO 1083 *Guide to the Implementation of Education and Training Standards in Meteorology and Hydrology*, Volume I, and WMO 1205 *Guide to Competency*.

AMC1 ATM/ANS.OR.B.005(a)(7) Management system

ED Decision 2017/001/R

COMMUNICATION RESPONSIBILITIES

The senior management should ensure that appropriate communication processes are established within the service provider and that communication takes place regarding the effectiveness of the management system.

AMC1 ATM/ANS.OR.B.005(b) Management system

ED Decision 2017/001/R

SERVICE PROVIDER'S MANAGEMENT SYSTEM DOCUMENTATION

A service provider's management system documentation should at least include the following information:

- (a) a statement signed by the accountable manager to confirm that the service provider will continuously work in accordance with the applicable requirements and the service provider's documentation as required by this Part and other applicable Parts;
- (b) the service provider's scope of activities;
- (c) the titles and names of nominated postholders referred to in [ATM/ANS.OR.B.020\(b\)](#);

- (d) the service provider's chart showing the lines of responsibility between the persons referred to in [ATM/ANS.OR.B.020\(b\)](#);
- (e) a general description and location of the facilities referred to in [ATM/ANS.OR.B.025](#);
- (f) procedures describing the function and specifying how the service provider monitors and ensures compliance with the applicable requirements referred to in [ATM/ANS.OR.B.005\(c\)](#); and
- (g) the amendment procedure for the service provider's management system documentation.

GM1 ATM/ANS.OR.B.005(b) Management system

ED Decision 2017/001/R

SERVICE PROVIDER'S MANAGEMENT SYSTEM DOCUMENTATION

- (a) It is not required to duplicate information in several manuals. The information may be contained in the service provider's manuals (e.g. operations manual, training manual), which may also be combined.
- (b) A service provider may also choose to document some of the information required to be documented in separate documents (e.g. procedures). In this case, it should ensure that manuals contain adequate references to any document kept separately. Any such documents are then to be considered an integral part of the service provider's management system documentation.
- (c) A service provider's management system documentation may be included in a separate manual or in (one of) the manual(s) as required by the applicable subpart(s). A cross reference should be included.

AMC1 ATM/ANS.OR.B.005(c) Management system

ED Decision 2017/001/R

COMPLIANCE MONITORING — GENERAL FOR COMPLEX SERVICE PROVIDERS

- (a) Compliance monitoring

The implementation and use of a compliance monitoring function should enable the service provider to monitor compliance with the relevant requirements of this Part and other applicable Parts.

 - (1) A service provider should specify the basic structure of the compliance monitoring function applicable to the activities conducted.
 - (2) The compliance monitoring function should be structured according to the size of the service provider and the complexity of the activities to be monitored, including those which have been subcontracted.
- (b) A service provider should monitor compliance with the procedures they have designed to ensure that services are provided with the required safety levels and quality, as applicable. In doing so, they should as a minimum, and where appropriate, monitor:
 - (1) manuals, logs, and records;
 - (2) training standards; and
 - (3) management system procedures.

(c) Organisational set-up

- (1) A person should be responsible for compliance monitoring to ensure that the service provider continues to meet the requirements of this Part and other applicable Parts. The accountable manager should ensure that sufficient resources are allocated for compliance monitoring.
- (2) Personnel involved in the compliance monitoring should have access to all parts of service provider and, as necessary, any contracted organisation.
- (3) In the case the person responsible for compliance monitoring acts also as safety manager, the accountable manager, with regard to his or her direct accountability for safety, should ensure that sufficient resources are allocated to both functions, taking into account the size of the service provider and the nature and complexity of its activities.
- (4) The independence of the compliance monitoring function should be established by ensuring that audits and inspections are carried out by personnel not directly involved in the activity being audited.

(d) Compliance monitoring documentation

- (1) Relevant documentation should include relevant part(s) of the service provider's management system documentation.
- (2) In addition, relevant documentation should also include:
 - (i) terminology;
 - (ii) specified activity standards;
 - (iii) a description of the service provider;
 - (iv) allocation of duties and responsibilities;
 - (v) procedures to ensure compliance;
 - (vi) the compliance monitoring programme, reflecting:
 - (A) the schedule of the monitoring programme;
 - (B) audit procedures;
 - (C) reporting procedures;
 - (D) follow-up and corrective action procedures; and
 - (E) the record-keeping system;
 - (vii) the training syllabus referred to in (e)(2); and
 - (viii) document control.

(e) Training

- (1) Correct and thorough training is essential to optimise compliance in every service provider. In order to achieve significant outcomes of such training, the service provider should ensure that all personnel understand the objectives as laid down in the service provider's management system documentation.
- (2) Those responsible for managing the compliance monitoring function should receive training on this task. Such training should cover the requirements of compliance monitoring, manuals and procedures related to the task, audit techniques, reporting and recording.

- (3) Time should be provided to train all personnel involved in compliance management and for briefing the remainder of the personnel.
- (4) The allocation of time and resources should be governed by the volume and complexity of the activities concerned.

GM1 ATM/ANS.OR.B.005(c) Management system

ED Decision 2017/001/R

COMPLIANCE MONITORING ORGANISATIONAL SET-UP

- (a) The role of the compliance monitoring may be performed by a compliance monitoring manager to ensure that the activities of the service provider are monitored for compliance with the applicable regulatory requirements and any additional requirements established by the service provider, and that these activities are being carried out properly under the supervision of other relevant nominated postholders and line managers.
- (b) The compliance monitoring manager should:
 - (1) be responsible for ensuring that the compliance monitoring programme is properly implemented, maintained, and continually reviewed and improved;
 - (2) have direct access to the accountable manager;
 - (3) not be one of the line managers; and
 - (4) be able to demonstrate relevant knowledge, background and appropriate experience related to the activities of the service provider, including knowledge and experience in compliance monitoring.
- (c) The compliance monitoring manager may perform all audits and inspections himself/herself or appoint one or more auditors by choosing personnel having the related competence as defined in point (b)(iii), either from within or outside the service provider.
- (d) Regardless of the option chosen, it needs to be ensured that the independence of the audit function is not affected, in particular in cases where those performing the audit or inspection are also responsible for other activities within the service provider.
- (e) In case external personnel are used to perform compliance audits or inspections:
 - (1) any such audits or inspections are performed under the responsibility of the compliance monitoring manager; and
 - (2) the compliance monitoring manager remains responsible for ensuring that the external personnel has relevant knowledge, background and experience as appropriate to the activities being audited or inspected, including knowledge and experience in compliance monitoring.
- (f) A service provider retains the ultimate responsibility for the effectiveness of the compliance monitoring function, in particular for the effective implementation and follow-up of all corrective actions.

AMC1 ATM/ANS.OR.B.005(d) Management system

ED Decision 2017/001/R

REACTION TO UNDERPERFORMANCE OF FUNCTIONAL SYSTEMS

If the cause of the underperformance is found to be:

- (a) a flaw in the functional system, the service provider should initiate a change to the functional system either to remove the flaw or mitigate its effects;
- (b) a flawed argument associated with a change to that functional system, the service provider should either:
 - (1) provide a valid argument; or
 - (2) where the service provider considers it more feasible, initiate a change to the functional system.

AMC1 ATM/ANS.OR.B.005(e) Management system

ED Decision 2017/001/R

SIZE, NATURE AND COMPLEXITY OF THE ACTIVITY

- (a) An air traffic services provider should be considered as complex unless it is eligible to apply for a limited certificate and fulfils the criteria set out in [ATM/ANS.OR.A.010\(a\)](#).
- (b) An air navigation services provider, other than an air traffic services provider, should be considered as complex unless it is eligible to apply for a limited certificate and fulfils the criteria set out in [ATM/ANS.OR.A.010\(b\)\(1\)](#).
- (c) An aerodrome flight information services provider should be considered as complex unless it is eligible to apply for a limited certificate and fulfils the criteria set out in [ATM/ANS.OR.A.010\(b\)\(2\)](#).
- (d) A service provider, other than an air navigation services provider, should be considered as complex when it has a workforce of more than 20 full-time equivalents (FTEs) involved in the activity subject to [Regulation \(EC\) No 216/2008](#) and its implementing rules.

GM1 ATM/ANS.OR.B.005(e) Management system

ED Decision 2017/001/R

SIZE, NATURE AND COMPLEXITY OF THE ACTIVITY

- (a) In consideration of the EUR 1 000 000 gross annual turnover referred to in [ATM/ANS.OR.A.010\(b\)\(1\)](#), this is assessed against the income the air navigation services provider generates in the provision of the services specified in Annex Vb to [Regulation \(EC\) No 216/2008](#) and does not include any income generated by the air navigation services provider who undertakes other commercial activity that generates income.
- (b) In consideration of operating regularly not more than one working position at any aerodrome referred to in [ATM/ANS.OR.A.010\(b\)\(2\)](#), this means that for the majority (i.e. greater than 50 %) of time an aerodrome is operational, only one working position is used.

- (c) Table 3 below illustrates the circumstances under which the service provider could be considered as non-complex.

Type of service	Criteria to be complied with
Air traffic services	Eligible for limited certificate and meets criteria in ATM/ANS.OR.A.010(a)
CNS/MET/AIS	Eligible for limited certificate and meets criteria in ATM/ANS.OR.A.010(b)(1)
AFIS	Eligible for limited certificate and meets criteria in ATM/ANS.OR.A.010(b)(2)
ASM/ATFM/DAT	Workforce of 20 or less FTEs per service

Table 3: Non-complex service provider

GM1 ATM/ANS.OR.B.005(f) Management system

ED Decision 2017/001/R

GENERAL

Within the scope of this Regulation, only the air traffic services provider can identify hazards, assess the associated risks and mitigate or propose mitigating measures where necessary. This requirement implies that all service providers (air traffic services and non-air traffic services) establish formal interfaces (e.g. service level agreements, letters of understanding, memorandum of cooperation) between the relevant services providers themselves or between the service providers and other aviation undertakings (e.g. aerodrome operators) so as to ensure that hazards associated with the use of the services they provide are identified and the risks assessed and whenever needed mitigated. It does not imply that this has to be done by the service providers themselves (e.g. MET or AIS providers cannot do this by themselves) as only the air traffic services provider can, but they need to establish the interfaces with those service providers (ATS providers) or other aviation undertaking (e.g. aerodrome operators) who are able to do so. The formal interfaces could address the mitigation means put on the different providers (e.g. via requirements in a service level agreement).

GM2 ATM/ANS.OR.B.005(f) Management system

ED Decision 2017/001/R

LOCAL RUNWAY SAFETY TEAM

The service provider should participate in the local runway safety team (LRST) established by the aerodrome operator in accordance with [AMC1 ADR.OR.D.027](#) and [GM2 ADR.OR.D.027](#).

ATM/ANS.OR.B.010 Change management procedures

Regulation (EU) 2017/373

- (a) A service provider shall use procedures to manage, assess and, if necessary, mitigate the impact of changes to its functional systems in accordance with points [ATM/ANS.OR.A.045](#), [ATM/ANS.OR.C.005](#), [ATS.OR.205](#) and [ATS.OR.210](#), as applicable.
- (b) The procedures referred to in point (a) or any material modifications to those procedures shall:
- (1) be submitted, for approval, by the service provider to the competent authority;
 - (2) not be used until approved by the competent authority.
- (c) When the approved procedures referred to in point (b) are not suitable for a particular change, the service provider shall:
- (1) make a request to the competent authority for an exemption to deviate from the approved procedures;

- (2) provide the details of the deviation and the justification for its use to the competent authority;
- (3) not use the deviation before being approved by the competent authority.

AMC1 ATM/ANS.OR.B.010(a) Change management procedures

ED Decision 2017/001/R

GENERAL

- (a) The procedures, and the change of the procedures, used by a service provider to manage changes should cover the complete lifecycle of a change.
- (b) The service provider should show that the procedures address all the actions and all the evidence needed in order to comply with the requirements laid down in [ATM/ANS.OR.A.045](#), [ATS.OR.205](#), [ATS.OR.210](#), and [ATM/ANS.OR.C.005](#), as appropriate. For that purpose, the service provider should use a compliance matrix, which shows:
 - (1) which part of a procedure addresses which part of the Regulation (i.e. the requirement of the implementing rule); and
 - (2) the rationale explaining how the procedures demonstrate compliance with the Regulation.
- (c) The service provider should ensure that the roles and responsibilities for the change management processes are identified in the procedures.
- (d) Procedures should be submitted in a manner agreed between the service provider and the competent authority. Until an agreement is reached, the competent authority will prescribe the means of submission.
- (e) The procedure that defines the notification process for changes includes:
 - (1) the point of contact in charge of the notification of changes, e.g. person, or part of the organisation and the role;
 - (2) the means used for notification, e.g. fax, email, mail, use of database or others.
- (f) The management of change procedures should include a change identification procedure. This procedure, which is a precursor of the change notification process, should seek out potential changes, confirm that there is a real intent to implement them (propose the change) and, if so, initiate the notification process.

GM1 to AMC1 ATM/ANS.OR.B.010(a) Change management procedures

ED Decision 2017/001/R

COMPLIANCE MATRIX

The following example of a matrix could be used by the service provider to document the compliance status of its change management procedures.

Service provider	[Name of the provider]								
Provided services	ATS:	C:	N:	S:	MET:	AIS:	DAT:	ASM:	ATFCM:
	<input type="checkbox"/>	<input type="checkbox"/>	<input type="checkbox"/>	<input type="checkbox"/>	<input type="checkbox"/>	<input type="checkbox"/>	<input type="checkbox"/>	<input type="checkbox"/>	<input type="checkbox"/>

Date	MM/DD/YYYY
Version of the form	Vx.y
Submitted procedure(s)	Procedure 'XYZ' — version 'a.b' of MM/DD/YYYY
	Procedure 'JKL' — version 'c.d' of MM/DD/YYYY
	[...]

Requirement in the Regulation	AMC	Procedure	Rationale	Status	Competent authority comment
ATM/ANS.OR.A.045(c)	None	Procedure 'JKL' — version 'c.d' — Paragraph 4	Paragraph 4 states that the transition into operation of any functional change will occur following the completion of the activities required by the procedures XYZ, MNO, and ABC	Non-approved	To be assessed
ATM/ANS.OR.A.045(d)	AMC1 ATM/ANS.OR.A.045(d)	Procedure 'XYZ' — version 'a.b' — Paragraph 3	Paragraph 3 stresses that a change subject to competent authority review should not be allowed to be put into service before formal approval has been granted.	Approved	None

AMC2 ATM/ANS.OR.B.010(a) Change management procedures

ED Decision 2017/001/R

GENERAL

- (a) As part of the change management procedures, the service provider should keep a register of the records of all notified changes. The register should include:
- (1) the status of the implementation of the change, i.e. planned, under review, under implementation, implemented, or cancelled;
 - (2) the notification;
 - (3) (a link to) the location of the actual record, including a reference to all information passed to the competent authority in accordance with [ATM/ANS.OR.A.045\(a\)\(2\)](#).
- (b) In addition, when the changes are selected for review, the register should also include:
- (1) the review decision from the competent authority; and
 - (2) a link to records of the change approval by the competent authority.

GM1 ATM/ANS.OR.B.010(a) Change management procedures

ED Decision 2017/001/R

GENERAL

- (a) The change management procedures for changes to functional systems should include:
- (1) the identification and notification of proposed changes;
 - (2) the identification of the scope of the change, i.e. the identification of what parts of the functional system are to be changed or are affected by the change;
 - (3) the assessment and assurance of the change;
 - (4) the approval of the change; and
 - (5) the establishment of the monitoring criteria to ensure that the change will remain acceptable as long as it is in operation (acceptably safe for air traffic service providers or acceptably trustworthy for other service providers). The monitoring of the changed system is part of the activities related to the management system of the service provider. It is not covered by the change management procedures themselves.
- (b) The procedures that manage changes to functional systems do not include the processes to identify the circumstances that will trigger the change. These should be part of the management system(s) as laid down in [ATM/ANS.OR.B.005](#) and/or [ATS.OR.200](#), as applicable.
- (c) The change management procedures should address the following:
- (1) procedural-oriented content, which details:
 - (i) the roles and activities with regard to change management, safety assessment and safety support assessment;
 - (ii) the identification of the parts of the functional system affected by the proposed change;
 - (iii) the type of safety assessment or safety support assessment that has to be used for the identified type of changes;
 - (iv) the competence of the persons performing change management, safety assessments and safety support assessments;
 - (v) the identified triggers for performing a safety assessment and a safety support assessment;
 - (vi) the means of change notification; ‘means’ includes the form of notification;
 - (vii) the means of identifying any organisations or aviation undertakings using the service that are potentially affected by the change; and
 - (viii) the means of informing those identified in (vii).
 - (2) Method-oriented content, which details description of the safety assessments and safety support assessments methods and mitigation methods used by the service provider.
- (d) For each change management procedure or part of a change management procedure approved, the agreement on notification of any change over them should be documented and formalised. In any case, the service provider should keep records of these changes.

ATM/ANS.OR.B.015 Contracted activities

Regulation (EU) 2017/373

- (a) Contracted activities include all the activities within the scope of the service provider's operations, in accordance with the terms of the certificate, that are performed by other organisations either themselves certified to carry out such activity or if not certified, working under the service provider's oversight. A service provider shall ensure that when contracting or purchasing any part of its activities to external organisations, the contracted or purchased activity, system or constituent conforms to the applicable requirements.
- (b) When a service provider contracts any part of its activities to an organisation that is not itself certified in accordance with this Regulation to carry out such activity, it shall ensure that the contracted organisation works under its oversight. The service provider shall ensure that the competent authority is given access to the contracted organisation to determine continued compliance with the applicable requirements under this Regulation.

AMC1 ATM/ANS.OR.B.015 Contracted activities

ED Decision 2017/001/R

RESPONSIBILITY WHEN CONTRACTING ACTIVITIES

- (a) A contract should exist between the service provider and the contracted organisation clearly defining the contracted activities and the applicable requirements, including training and competences requirements for air traffic safety electronics personnel (ATSEP) employed by the contracted organisation, where applicable.
- (b) The contracted activities, performed by an organisation that is not itself certified in accordance with this Regulation to carry out such activity, should be included in the service provider's oversight process. In this context, where the contracted activity requires the ATSEP employed by contracted organisation to undertake any aspect of this activity, the service provider should ensure that those ATSEP have received the applicable training and competences foreseen in Subpart A of [Annex XIII](#).
- (c) A service provider should ensure that the contracted organisation has the necessary authorisation, declaration or approval when required, and commands the resources and competence to undertake the task.

GM1 to AMC1 ATM/ANS.OR.B.015 Contracted activities

ED Decision 2017/001/R

RESPONSIBILITY WHEN CONTRACTING ACTIVITIES

The applicable requirements may include the necessary elements from the training and competence assessment of ATSEP laid down in [Annex XIII](#) to this Regulation in accordance with [ATSEP.OR.105](#) in order to ensure equivalent level of safety and level playing field for the maintenance of systems and equipment regardless of whether such services are provided internally in the service provider or outsourced.

AMC2 ATM/ANS.OR.B.015 Contracted activities

ED Decision 2017/001/R

RESPONSIBILITY WHEN CONTRACTING ACTIVITIES

- (a) When the contracted organisation is itself certified in accordance with this Regulation to carry out the contracted activities, the service providers' compliance monitoring should at least check that the approval effectively covers the contracted activities and that it is still valid.
- (b) When the service provider is not certified itself to provide the service, it should only contract or purchase services from a certified organisation when so required by this Regulation.

AMC3 ATM/ANS.OR.B.015 Contracted activities

ED Decision 2017/001/R

SAFETY — ATS PROVIDER

An air traffic services provider should ensure adequate justification of the safety of the externally provided and supplied services, having regard to their safety significance within the provision of its services.

GM1 ATM/ANS.OR.B.015 Contracted activities

ED Decision 2017/001/R

GENERAL

- (a) A service provider may contract certain activities to external organisations. 'Contracted activities' means those activities within the service provision conditions attached to the service provider's certificate that are performed by other organisations either themselves certified to carry out such an activity or if not certified, working under the service provider's oversight. The scope of the service provider's oversight covers the contracted activities performed by the external organisation that is not itself certified in accordance with this Regulation.
- (b) Activities contracted to external organisations for the provision of services may include areas such as:
 - (1) aeronautical information services;
 - (2) meteorological services, etc.
- (c) In the case of activities contracted, the service provider should define relevant management responsibilities within its own organisation.
- (d) The ultimate responsibility for the services provided by contracted organisations should always remain with the contracting service provider.

GM2 ATM/ANS.OR.B.015 Contracted activities

ED Decision 2017/001/R

RESPONSIBILITY WHEN CONTRACTING ACTIVITIES

- (a) A contract could take the form of a written agreement, letter of agreement, service letter agreement, memorandum of understanding, etc. as appropriate for the contracted activities.
- (b) A service provider's assurance process could be included into the service provider's management system and compliance monitoring programmes.

- (c) In order to ensure that the contracted organisation is able to perform the contracted activities, the service provider may conduct a prior audit of the contracted party.

GM3 ATM/ANS.OR.B.015 Contracted activities

ED Decision 2017/001/R

RESPONSIBILITY WHEN CONTRACTING ACTIVITIES

- (a) Regardless of the approval status of the contracted organisation, the service provider is responsible for ensuring that all contracted activities are subject to compliance monitoring as required by [ATM/ANS.OR.B.005\(c\)](#), and in the case of air traffic services provider, also to hazard identification and risk management as required by [ATS.OR.200\(2\)](#).
- (b) If a service provider requires a contracted organisation to conduct an activity which exceeds the privileges of the contracted organisation's certificate, this will be considered as the contracted organisation working under the approval and oversight of the contracting service provider.

GM4 ATM/ANS.OR.B.015 Contracted activities

ED Decision 2017/001/R

RESPONSIBILITY WHEN CONTRACTING ACTIVITIES

Table 4 below illustrates the responsibilities when contracting.

	Contracted activity — subject to certification; and — the contracting service provider certified for that activity	Contracted activity — subject to certification; and — contracting service provider NOT certified for that activity
Contracted external organisation certified to provide the activity	A contracting service provider undertakes compliance monitoring of the contracted external organisation and should at least check that the certificate effectively covers the contracted activities and that it is valid.	A contracting service provider undertakes compliance monitoring of the contracted external organisation and should at least check that the certificate effectively covers the contracted activities and that it is valid.
Contracted external organisation NOT certified to provide the activity	The contracted external organisation works under the oversight of the contracting service provider.	The activity cannot be contracted to the external organisation.

Table 4: Responsibility when contracting activities

ATM/ANS.OR.B.020 Personnel requirements

Regulation (EU) 2017/373

- (a) A service provider shall appoint an accountable manager, who has the authority over ensuring that all activities can be financed and carried out in accordance with the applicable requirements. The accountable manager shall be responsible for establishing and maintaining an effective management system.
- (b) A service provider shall define the authority, duties and responsibilities of the nominated post holders, in particular of the management personnel in charge of safety, quality, security, finance and human resources-related functions as applicable.

GM1 ATM/ANS.OR.B.020(a) Personnel requirements

ED Decision 2017/001/R

ACCOUNTABLE MANAGER

Depending on the size, structure and complexity of the organisation, the accountable manager may be:

- (a) the chief executive officer (CEO);
- (b) the chief operating officer (COO);
- (c) the chairperson of the board of directors;
- (d) a partner; or
- (e) the proprietor.

AMC1 ATM/ANS.OR.B.020(b) Personnel requirements

ED Decision 2017/001/R

GENERAL

Senior management should appoint a member of the service provider's management who, irrespective of other responsibilities, should have responsibility and authority that includes:

- (a) ensuring that processes needed for the management system are established, implemented and maintained;
- (b) reporting to senior management on the performance of the management system and any need for improvement; and
- (c) ensuring the promotion of awareness of performance and service requirements throughout the service provider and of the impact it has on safety.

GM1 ATM/ANS.OR.B.020(b) Personnel requirements

ED Decision 2017/001/R

COMBINATION OF NOMINATED POSTHOLDERS RESPONSIBILITIES

- (a) The acceptability of a single person holding more than one post, possibly in combination with being the accountable manager, should depend upon the service provider's organisation and the complexity of its activities. The two main areas of concern should be competence and an individual's capacity to meet his or her responsibilities.
- (b) As regards competence in different areas of responsibility, there should not be any difference from the requirements applicable to persons holding only one post.

The capacity of an individual to meet his or her responsibilities should primarily be dependent upon the complexity of the service provider's organisation and its activities. However, the complexity of the service provider's organisation or of its activities may prevent or limit the combination of posts

ATM/ANS.OR.B.025 Facilities requirements

Regulation (EU) 2017/373

A service provider shall ensure that there are adequate and appropriate facilities to perform and manage all tasks and activities in accordance with the applicable requirements.

ATM/ANS.OR.B.030 Record-keeping

Regulation (EU) 2017/373

- (a) A service provider shall establish a system of record-keeping that allows adequate storage of the records and reliable traceability of all its activities, covering in particular all the elements indicated in point [ATM/ANS.OR.B.005](#).
- (b) The format and the retention period of the records referred to in point (a) shall be specified in the service provider's management system procedures.
- (c) Records shall be stored in a manner that ensures protection against damage, alteration and theft.

AMC1 ATM/ANS.OR.B.030 Record-keeping

ED Decision 2017/001/R

GENERAL

- (a) The record-keeping system should ensure that all the records required in [ATM/ANS.OR.B.030\(a\)](#) are accessible whenever needed. These records should be organised in a way that ensures traceability and retrieval throughout the retention period.
- (b) Records should be kept in paper form or in electronic format or a combination of both. Records stored on microfilm or optical disc format are also acceptable. The records should remain legible throughout the required retention period. The retention period starts when a record has been created or last amended.
- (c) Paper systems should use robust material which can withstand normal handling and filing.
- (d) Computer systems should have at least one backup system which should be updated within 24 hours of any new entry. Computer systems should include safeguards against the probability of unauthorised personnel altering the data.
- (e) All computer hardware used to ensure data backup should be stored in a different location from that containing the working data and in an environment that ensures they remain in good condition. When hardware or software changes take place, special care should be taken that all necessary data continues to be accessible at least through the full retention period.

GM1 ATM/ANS.OR.B.030 Record-keeping

ED Decision 2017/001/R

GENERAL

The record-keeping provision is intended to address the management system records rather than operational data which is covered by other record-keeping applicable requirements.

AMC1 ATM/ANS.OR.B.030(b) Record-keeping

ED Decision 2017/001/R

RETENTION PERIOD

The records should be kept for a minimum period of at least 5 years unless otherwise specified by the competent authority.

ATM/ANS.OR.B.035 Operations manuals

Regulation (EU) 2017/373

- (a) A service provider shall provide and keep up to date its operations manuals relating to the provision of its services for the use and guidance of operations personnel.
- (b) It shall ensure that:
 - (1) operations manuals contain the instructions and information required by the operations personnel to perform their duties;
 - (2) relevant parts of the operations manuals are accessible to the personnel concerned;
 - (3) the operations personnel are informed of amendments to the operations manual applying to their duties in a manner that enables their application as of their entry into force.

SUBPART C — SPECIFIC ORGANISATION REQUIREMENTS FOR SERVICE PROVIDERS OTHER THAN ATS PROVIDERS (ATM/ANS.OR.C)

ATM/ANS.OR.C.001 Scope

Regulation (EU) 2017/373

This Subpart establishes the requirements to be met by the service provider other than the air traffic services provider, in addition to the requirements set out in Subparts A and B.

ATM/ANS.OR.C.005 Safety support assessment and assurance of changes to the functional system

Regulation (EU) 2017/373

- (a) For any change notified in accordance with point [ATM/ANS.OR.A.045\(a\)\(1\)](#), the service provider other than the air traffic services provider shall:
- (1) ensure that a safety support assessment is carried out covering the scope of the change which is:
 - (i) the equipment, procedural and human elements being changed;
 - (ii) interfaces and interactions between the elements being changed and the remainder of the functional system;
 - (iii) interfaces and interactions between the elements being changed and the context in which it is intended to operate;
 - (iv) the life cycle of the change from definition to operations including transition into service;
 - (v) planned degraded modes;
 - (2) provide assurance, with sufficient confidence, via a complete, documented and valid argument that the service will behave and will continue to behave only as specified in the specified context.
- (b) A service provider other than an air traffic services provider shall ensure that the safety support assessment referred to in point (a) comprises:
- (1) verification that:
 - (i) the assessment corresponds to the scope of the change as defined in point (a)(1);
 - (ii) the service behaves only as specified in the specified context;
 - (iii) the way the service behaves complies with and does not contradict any applicable requirements of this Regulation placed on the services provided by the changed functional system; and
 - (2) specification of the monitoring criteria necessary to demonstrate that the service delivered by the changed functional system will continue to behave only as specified in the specified context.

GM1 ATM/ANS.OR.C.005(a)(1) Safety support assessment and assurance of changes to the functional system

ED Decision 2017/001/R

GENERAL

- (a) The safety support assessment should be conducted by the service provider itself. It may also be carried out by another organisation, on its behalf, provided that the responsibility for the safety support assessment remains with the service provider.
- (b) A safety support assessment needs to be performed when a change affects a part of the functional system managed by a service provider other than an air traffic services provider and it is being used in the provision of its services. The safety support assessment or the way it is conducted does not depend on whether the change is a result of a business decision or a decision to improve the service performance.

GM2 ATM/ANS.OR.C.005(a)(1) Safety support assessment and assurance of changes to the functional system

ED Decision 2017/001/R

SAFETY SUPPORT ASSESSMENTS BY PROVIDERS THAT ARE ALSO ATS PROVIDERS

- (a) Only air traffic services providers can perform a safety assessment. Service providers other than air traffic services providers can only perform a safety support assessment to determine that the new or changed service behaves only as specified in a specified context.
- (b) A safety support assessment should be carried out for changes that cross the organisation's boundary.
- (c) An air traffic services provider may choose not to perform a safety support assessment of changes to its functional system when the changes do not cross the organisation's boundary. In this specific case, the safety assessment of changes to the functional system should be performed.

GM3 ATM/ANS.OR.C.005(a)(1) Safety support assessment and assurance of changes to the functional system

ED Decision 2017/001/R

SAFETY SUPPORT ASSESSMENT

- (a) A safety support assessment is needed whenever the functional system of a service provider other than an air traffic services provider changes. This may be as a result of:
 - (1) the provider proposing a change to:
 - (i) its functional system;
 - (ii) the services it provides;
 - (iii) the context in which its functional system operates; or
 - (iv) the context in which the service is provided;
 - (2) the services used by the provider in the delivery of its services being planned to change; or/and

- (3) a change to the context in which the service provider's functional system operates as a result of a proposed change by another service provider, another organisation regulated by [Regulation \(EC\) No 216/2008](#) or an unregulated body.
- (b) The granularity of the safety support case report will depend on:
 - (1) the scope of the change;
 - (2) the nature and number of arguments; and
 - (3) the necessary and sufficient evidence needed to provide appropriate confidence that the safety support assurance is valid (complete and correct).

GM4 ATM/ANS.OR.C.005(a)(1) Safety support assessment and assurance of changes to the functional system

ED Decision 2017/001/R

SCOPE OF THE CHANGE

- (a) The description of the elements being changed includes the nature, functionality, location, performance, maintenance tasks, training and responsibilities of these elements, where applicable. The description of interfaces and interactions, between machines and between humans and machines, should include communication means, e.g. language, phraseology, protocol, format, order and timing and transmission means, where applicable. In addition, it includes the description of the context in which they operate.
- (b) There are two main aspects to consider in evaluating the scope of a change:
 - (1) The interactions within the changed functional system.
 - (2) The interactions within the changing functional system, i.e. those that occur during transitions from the current functional system to the changed system. During such transitions, components are replaced/installed in the functional system. These installation activities are interactions within the changing functional system and are to be included within the scope of the change.

As each transition can be treated as a change to the functional system, the identification of both the above has a common approach described below.

- (c) The scope of the change is defined as the set of the changed components and affected components. In order to identify the impacted components and the changed components, it is necessary to:
 - (1) know which components will be changed;
 - (2) know which component's (components') behaviour might be affected by the changed components, although it is (they are) not changed itself (themselves); and
 - (3) detect indirectly affected components by identifying:
 - (i) new interactions introduced by the changed or directly affected components;
 - (ii) interactions with changed or directly affected components via the context.

Furthermore, directly and indirectly impacted components will be identified as a result of applying the above iteratively to any directly and indirectly impacted components that have been identified previously.

The scope of the change is the set of changed, directly impacted and indirectly impacted components identified when the iteration identifies no new components.

- (d) The context in which the changed service is intended to be provided (see [ATM/ANS.OR.C.005\(a\)\(1\)\(iii\)](#)) includes the interface through which the service will be delivered to other service providers.

GM5 ATM/ANS.OR.C.005(a)(1) Safety support assessment and assurance of changes to the functional system

ED Decision 2017/001/R

TRAINING

If the change modifies the way people interact with the rest of the functional system, then they will require training before the change becomes operational. Care should be taken when training operational staff before the change is operational, as the training may change the behaviour of the operational staff when they interact with the existing functional system before any other part of the change is made, and so the training may have to be treated as a transitional stage of the change. For example, as a result of training, ATCOs may come to expect information or alerts to be presented differently. People may also need refreshment training periodically in order to ensure that their performance does not degrade over time. The training needed before operation forms part of the design of the change, while the refreshment training is part of the maintenance of the functional system after the change is in operation.

GM6 ATM/ANS.OR.C.005(a)(1) Safety support assessment and assurance of changes to the functional system

ED Decision 2017/001/R

INTERACTIONS

The identification of changed interactions is necessary in order to identify the scope of the change because any changed behaviour in the system comes about via a changed interaction. Changed interaction happens via an interaction at an interface of the functional system and the context in which it operates. Consequently, identification of both interfaces and interactions is needed to ensure that all interactions have identified interfaces and all interfaces have identified interactions. From this, all interactions and interfaces that will be changed can be identified.

AMC1 ATM/ANS.OR.C.005(a)(2) Safety support assessment and assurance of changes to the functional system

ED Decision 2017/001/R

FORM OF ASSURANCE

Service providers other than air traffic services providers should ensure that the assurance is documented in a safety support case.

AMC2 ATM/ANS.OR.C.005(a)(2) Safety support assessment and assurance of changes to the functional system

ED Decision 2017/001/R

COMPLETENESS OF THE ARGUMENT

The argument should be considered complete when it shows that:

- (a) the safety support assessment of [ATM/ANS.OR.C.005\(b\)](#) has produced a service specification and context specification where:
 - (1) the service has been defined in terms of functionality, performance and the form of the interfaces;
 - (2) the specification of context correctly and completely records the conditions under which the specification of the service is true;
 - (3) the interaction of components, under failure conditions or failures in services delivered to the components, have been assessed for their impact on the service and, where necessary, degraded modes of service have been defined; and
 - (4) the specification encompasses the interaction with the environment;
- (b) safety support requirements have been placed on the elements changed and on those elements affected by the change;
- (c) the behaviour necessitated by the safety support requirements is the complete behaviour expressed by the service specification;
- (d) all safety support requirements have been traced from the service specification to the level of the architecture at which they have been satisfied;
- (e) each component satisfies its safety support requirements; and
- (f) the evidence is derived from known versions of the components and the architecture and known sets of products, data and descriptions that have been used in the production or verification of those versions.

GM1 to AMC2 ATM/ANS.OR.C.005(a)(2) Safety support assessment and assurance of changes to the functional system

ED Decision 2017/001/R

COMPLETENESS OF THE ARGUMENT

- (a) Sufficiency of specifications

The way the service specification is arrived at is not of particular interest in a safety support case and so it is not dealt with here. A specification that is sufficient implies that the service meets the provider's intent, i.e. it is valid. Two necessary conditions for a sufficient specification are provided here:

(1) Assessment of failure conditions

(i) Failures or failure conditions are malfunctions of behaviour. This means either the loss or corruption of some intended behaviour, e.g. behaviour that is considered to be:

- (A) more than (quantity, information);
- (B) less than (quantity, information);
- (C) additional to;
- (D) faster than;
- (E) slower than;
- (F) part of;
- (G) reverse of;
- (H) other than;
- (I) not;
- (J) earlier than;
- (K) later than;
- (L) before; or
- (M) after

that which was intended. If the behaviour of the service is altered in any way during malfunctions, the altered behaviour needs to be included in the specification. Further details could be found [GM1 ATM/ANS.OR.C.005\(b\)\(1\)](#) and [GM1 ATM/ANS.OR.C.005\(b\)\(2\)](#).

(ii) Some failures may not result in a degraded service.

(iii) Some failures may not be relevant in the context of use.

(iv) Strictly speaking, the failure and failure conditions described here are malfunctions of the services delivered by a component and may be caused by failures of components, errors in design, failures of services used by the component, or failures of the activities associated with installing the component, i.e. failure to install the component in the intended manner.

(v) When a redundancy within a component is no longer available, the behaviour of the component is considered to have changed, e.g. the reliability of the component will have changed and an indication of the loss of redundancy will have been provided.

(2) Evaluation of the behaviour

It is necessary to argue that the behaviour of the implementation, i.e. the system as built, matches the specification and there is no additional (unspecified) behaviour. This implies verification of service behaviour, which is required by [ATM/ANS.OR.C.005\(b\)\(2\)](#) and stated here in a more specific way.

It is also necessary to argue that the behaviour of the change during transition into service matches the specification and there is no additional (unspecified) behaviour. If transition into service causes disruption to the service being changed or other services provided by the service provider, then it may be necessary to include, within the specification, a specification of the intended installation activities. This implies an assessment of failure conditions associated with the installation activities and the specification of any necessary mitigations, should the failures materialise and the installation not be performed as intended.

(b) Safety support requirements

- (1) The safety support requirements are characteristics/items of the functional system to ensure that the system operates as specified. Based on the verification/demonstration of these characteristics/items, it could be concluded that the specifications are met.
- (2) The highest-layer of safety support requirements represents the desired behaviour of the change at its interface with the operational context. These, ultimately become the specification, once the implementation is verified.
- (3) In almost all cases, verification that a system behaves as specified cannot be accomplished to an acceptable level of confidence at the level of its interface with its operational environment. To this end, the system verification should be decomposed into verifiable parts, taking into account the following principles:
 - (i) Verification relies on requirements placed on these parts via a hierarchical decomposition of the top-level requirements, in accordance with the constraints imposed by the chosen architecture.
 - (ii) At the lowest level, this decomposition places requirements on elements, where verification that the implementation satisfies its requirements can be achieved by testing.
 - (iii) At higher levels in the architecture, during integration, verified elements of different types are combined into subsystems/components, in order to verify more complete parts of the system.
 - (iv) While they cannot be fully tested, other verification techniques may be used to provide sufficient levels of confidence that these subsystems/components do what they are supposed to do.
 - (v) Consequently, since decomposing the system into verifiable parts relies on establishing requirements for those parts, then safety support requirements are necessary.
- (4) The way safety support requirements are achieved, is not of particular interest in a safety assessment, because a safety support argument demonstrates the trustworthiness of the specification.
- (5) The architecture may not have requirements. During development, the need to argue satisfaction of system level requirements, which cannot be performed at the system level for any practical system, drives the architecture because verifiability depends on the decomposition of the system into verifiable parts.
- (6) Demonstration that safety support requirements at system level are met allows them to be transformed into the safety support specification.

(c) Satisfaction of safety support requirements

- (1) The concept laid down in [AMC2 ATM/ANS.OR.C.005\(a\)\(2\)](#) is that, provided the system and each subsystem/component/element meet its requirements, the system will behave as specified. This will be true provided (2), (3) and (4) below are met.
- (2) The activity needed to meet objective (c) of [AMC2 ATM/ANS.OR.C.005\(a\)\(2\)](#) consists of obtaining sufficient confidence that the set of requirements is complete and correct, i.e. that:
 - (i) the architectural decomposition leads to a complete and correct set of requirements being allocated to each subsystem/component/element;
 - (ii) each requirement is a correct, complete and unambiguous statement of the desired behaviour, and does not contradict another requirement or any other subset of requirements; and
 - (iii) the requirements allocated to a subsystem/component/element necessitate the complete required behaviour of the subsystem/component/element in the target environment.
- (3) This should take into account specific aspects such as:
 - (i) the possible presence of functions within the subsystem/component/element that produce unnecessary behaviour. For instance, in the case where a previously developed part is used, activities should be undertaken to identify all the possible behaviours of the part. If any of these behaviours is not needed for the foreseen use, then additional requirements may be needed to make sure that these functions are not solicited or inadvertently activated in operation or that the effects of any resulting behaviour are mitigated;
 - (ii) subsystem/component/element requirements that are not directly related to the desired behaviour of the functional system. This kind of requirement can, for instance, ask that the subsystem/component/element be developed in a given syntax or be designed in a certain way. These requirements often relate to technical aspects of the subsystem/component/element. Activities should be undertaken to ensure that each of these requirements is a correct, complete and unambiguous statement of the desired effect, and does not contradict another requirement or any other subset of requirements.
- (4) The system behaviour should be considered complete in the sense that the specification is only true for the defined context. This restriction to the context of the use of the service makes safety support assessment and assurance of changes to the functional system a practical proposition.

(d) Traceability of requirements

The traceability requirement can be met by tracing to the highest-level element in the architectural hierarchy that has been shown to satisfy its requirements, by verifying it in isolation. It is likely and completely acceptable that this point will be reached at a different architectural level for each element.

-
- (e) Satisfaction of safety support requirements
- (1) The component view taken must be able to support verification, i.e. the component must be verifiable — see guidance in (b).
 - (2) Care should be taken in selecting subsystems that are to be treated as components for verification to ensure that they are small and simple enough to be verifiable.
 - (3) The context argument needs to demonstrate that the context in which a component is verified does not compromise the claim that the specification is true over a specified context, i.e. the component verification context is correctly related to the context claimed for the operation of the functional system.
- (f) Configuration identification
- (1) This is only about configuration of the evidence and should not be interpreted as configuration management of the functional system. However, since the safety support assessment is based on a set of elements and the way they are interlinked, the safety support assessment should only be valid if the configuration remains as described in the safety support argument.
 - (2) Evidence for the use of a component should rely on testing activities considering the actual usage of domains and contexts. When the same component is used in different parts of the system or in different systems, it may not be possible to rely on testing in a single context since it is unlikely that the contexts for each use will be the same or can be covered by a single set of test conditions. This applies equally to the reuse of evidence gathered from testing subsystems.

AMC3 ATM/ANS.OR.C.005(a)(2) Safety support assessment and assurance of changes to the functional system

ED Decision 2017/001/R

DETERMINATION OF THE SPECIFICATION OF THE CHANGED SERVICE

When determining the changes in the service specification that have resulted from the change to the functional system, service providers other than air traffic services providers should ensure that:

- (a) the properties specified for the service can be observed and measured either directly or indirectly with a degree of certainty commensurate with the level of confidence sought from assurance; and
- (b) the specification of the changed service must cover everything that has changed in the service provided when operated within the declared operational context.

AMC4 ATM/ANS.OR.C.005(a)(2) Safety support assessment and assurance of changes to the functional system

ED Decision 2017/001/R

DETERMINATION OF THE OPERATIONAL CONTEXT FOR THE CHANGE

- (a) When determining the operational context for the change, service providers other than an air traffic services provider should ensure that:
 - (1) the specification of the operational context can be shown to be true for all circumstances and environments in which the changed service is intended to operate;
 - (2) the operational context is completely and coherently specified; and
 - (3) the specification of the operational context is internally consistent.
- (b) The operational context must be specified so that its adherence to (a)(1) and (a)(2) is observable and measurable either directly or indirectly with a degree of certainty commensurate with the level of confidence sought from assurance.

AMC5 ATM/ANS.OR.C.005(a)(2) Safety support assessment and assurance of changes to the functional system

ED Decision 2019/022/R

ASSURANCE — SOFTWARE

- (a) When a change to a functional system includes the introduction of new software or modifications to existing software, the service provider should ensure the existence of documented software assurance processes necessary to produce evidence and arguments that demonstrate that the software behaves as intended (software requirements), with a level of confidence consistent with the needs of the required application.
- (b) The service provider should use feedback of software experience to confirm that the software assurance processes are effective and, when used, the allocated software assurance levels (SWALs) and the rigour of the assurances are appropriate. For that purpose, the effects from software malfunctions (i.e. the inability of a programme to perform a required function correctly) or failures (i.e. the inability of a programme to perform a required function) reported according to the relevant requirements on reporting and assessment of service occurrences should be assessed in comparison with the effects identified for the system concerned as per the service specification demonstration.

AMC6 ATM/ANS.OR.C.005(a)(2) Safety support assessment and assurance of changes to the functional system

ED Decision 2019/022/R

ASSURANCE — SOFTWARE ASSURANCE PROCESSES

- (a) The software assurance processes should provide evidence and arguments that they, as a minimum, demonstrate the following:
 - (1) The software requirements correctly state what is required by the software, in order to meet the service and safety support requirements, as identified by the safety support

-
- assessment ([AMC2 ATM/ANS.OR.C.005\(a\)\(2\)](#)). For that purpose, the software requirements should:
- (i) be correct, complete and compliant with the upper level requirements; and
 - (ii) specify the functional behaviour, in nominal and downgraded modes, timing performances, capacity, accuracy, resource usage on the target hardware, robustness to abnormal operating conditions and overload tolerance, as appropriate, of the software.
- (2) The traceability is addressed in respect of all software requirements as follows:
 - (i) Each software requirement should be traced to the same level of design at which its satisfaction is demonstrated.
 - (ii) Each software requirement allocated to a component should either be traced to an upper level requirement or its need should be justified and assessed that it does not affect the satisfaction of the safety support requirements allocated to the component.
 - (3) The software implementation does not contain functions that adversely affect the satisfaction of the service specification.
 - (4) The functional behaviour, timing performances, capacity, accuracy, resource usage on the target hardware, robustness to abnormal operating conditions and overload tolerance, of the implemented software comply with the software requirements.
 - (5) The software verification is correct and complete, and is performed by analysis and/or testing and/or equivalent means, as agreed with the competent authority.
- (b) The evidence and arguments produced by the software assurance processes should be derived from:
 - (1) a known executable version of the software;
 - (2) a known range of configuration data; and
 - (3) a known set of software items and descriptions, including specifications, that have been used in the production of that version, or can be justified as applicable to that version.
 - (c) The software assurance processes should determine the rigour to which the evidence and arguments are produced.
 - (d) The software assurance processes should include the necessary activities to ensure that the software life cycle data can be shown to be under configuration control throughout the software life cycle, including the possible evolutions due to changes or problems' corrections. They should include, as a minimum:
 - (1) configuration identification, traceability and status accounting activities, including archiving procedures;
 - (2) problem reporting, tracking and corrective actions management; and
 - (3) retrieval and release procedures.

- (e) The software assurance processes should also cover the particularities of specific types of software such as commercial-off-the-shelf (COTS), non-developmental software and previously developed software where generic assurance processes cannot be applied. The software assurance processes should include other means to give sufficient confidence that the software meets the service and safety support requirements. If sufficient assurance cannot be provided, complementary mitigation means aiming at decreasing the impact of specific failure modes of this type of software, should be applied. This may include but is not limited to:
- (1) software and/or system architectural considerations;
 - (2) existing service level experience; and
 - (3) monitoring.

GM1 to AMC6 ATM/ANS.OR.C.005(a)(2) Safety support assessment and assurance of changes to the functional system

ED Decision 2019/022/R

ASSURANCE — SOFTWARE ASSURANCE PROCESS

- (a) The term ‘correct and complete software verification’ is understood to be all software safety requirements, which correctly state what is required of the software component by the risk assessment and mitigation process and their implementation is demonstrated to the level required by the software assurance level.
- (b) The term ‘software timing performances’ is understood to be the time allowed for the software to respond to given inputs or to periodic events, and/or the performance of the software in terms of transactions or messages handled per unit time.
- (c) The term ‘software capacity’ is understood to be the ability of the software to handle a given amount of data flow.
- (d) The term ‘software accuracy’ is understood to be the required precision of the computed results.
- (e) The term ‘software resource usage’ is understood to be the amount of resources within the computer system that can be used by the application software.
- (f) The term ‘software robustness’ is understood to be the behaviour of the software in the event of unexpected inputs, hardware faults and power supply interruptions, either in the computer system itself or in connected devices.
- (g) The term ‘overload tolerance’ is understood to be the behaviour of the system in the event of, and in particular its tolerance to, inputs occurring at a greater rate than expected during normal operation of the system.
- (h) The term ‘software life cycle data’ is understood to be the data that is produced during the software life cycle to plan, direct, explain, define, record, or provide evidence of activities; this data enables the software life cycle processes, system or equipment approval and post-approval modification of the software item.
- (i) The term ‘COTS’ is understood to be a commercially available application sold by vendors through public catalogue listings and not intended to be customised or enhanced.

GM2 to AMC6 ATM/ANS.OR.C.005(a)(2) Safety support assessment and assurance of changes to the functional system

ED Decision 2019/022/R

ASSURANCE — SOFTWARE ASSURANCE LEVELS

- (a) The assurance required by [AMC6 ATM/ANS.OR.C.005\(a\)\(2\)](#) can be provided with different levels of confidence depending on the rigour to which the evidence and arguments are produced. Whereas, for air traffic services (ATS) providers, the use of the SWAL concept can be helpful to provide an explicit link between the criticality of the software and the rigour of the assurance, for service providers other than ATS providers, the use of the SWAL concept may not be relevant considering that non-ATS providers may not be aware of the safety aspects of the ATS provider using their services. However, considering that the safety support assessment will be based on the evidence and arguments generated by the software assurance processes and that the safety support assessment will support a safety assessment, it is foreseen that, in many changes, the software assurance evidence and arguments will have to demonstrate a certain level of confidence and therefore will have to show compliance with the SWAL allocated by the ATS provider.
- (b) The use of multiple SWALs would also allow the possibility of managing several criticalities of the different software components within the system (with partitioning or other architectural strategies) by the same set of software assurance processes. When the software assurance processes employ several SWALs, they should define for each SWAL the rigour of the assurances to achieve compliance with the objectives set out in [AMC6 ATM/ANS.OR.C.005\(a\)\(2\)](#). As a minimum:
- (1) the rigour should increase as the criticality of the service supported by the software solution increases; and
 - (2) the variation in rigour of the evidence and arguments per SWAL should include a classification of the activities and objectives according to the following criteria:
 - (i) required to be achieved with independence, i.e. the verification process activities are performed by a person (or persons) other than the developer of the item being verified;
 - (ii) required to be achieved; and
 - (iii) not required.

GM3 to AMC6 ATM/ANS.OR.C.005(a)(2) Safety support assessment and assurance of changes to the functional system

ED Decision 2019/022/R

ASSURANCE — SOFTWARE ASSURANCE LEVELS ALLOCATION

The process to allocate a SWAL to a software consistently with its foreseen criticality, as identified by the safety support assessment and requirements, should consider the following elements:

- (a) The SWAL allocation should relate the rigour of the software assurances to the foreseen criticality of the software.
- (b) The allocated SWAL should be commensurate with the worst credible effect that software malfunctions (i.e. the inability of a programme to perform a required function correctly) or

failures (i.e. the inability of a programme to perform a required function) may cause, as assessed by the ATS provider that is planning to make use of the non-ATS services.

- (c) The software components that cannot be shown to be independent of one another should be allocated to the SWAL of the most critical of the dependent components. In this context, the term ‘software components’ is understood to be a building block that can be fitted or connected together with other reusable blocks of software to combine and create a custom software application, and ‘independent software components’ are those software components which are not rendered inoperative by the same failure condition.
- (d) The allocated SWALs should be consistent with the levels defined in the software assurance processes.

GM4 to AMC6 ATM/ANS.OR.C.005(a)(2) Safety support assessment and assurance of changes to the functional system

ED Decision 2019/022/R

ASSURANCE — EXAMPLES OF EXISTING INDUSTRIAL STANDARDS

- (a) The service provider is responsible for the definition of the software assurance processes. In this definition of processes, the service provider may consider the guidance material contained in existing industrial standards for the software assurance considerations of software. It should be considered that not all standards address all aspects required and the service provider may need to define additional software assurance processes. The guidance material typically includes:
 - (1) objectives of the software life cycle processes;
 - (2) activities for satisfaction of those objectives;
 - (3) descriptions of the evidence, in the form of software life cycle data, that indicates that the objectives have been satisfied;
 - (4) variations according to the SWAL, to accommodate the different levels of rigour of the software assurances; and
 - (5) particular aspects (e.g. previously developed software) that may be applicable to certain applications.
- (b) The following table presents some of the existing industrial standards (at the latest available issue) used by the stakeholders:

Document title	Reference	Date
Software Integrity Assurance Considerations for Communication, Navigation, Surveillance and Air Traffic Management (CNS/ATM) Systems	EUROCAE ED109A/ RTCA DO278A	January 2012
Guidelines for ANS Software Safety Assurance	EUROCAE ED-153	August 2009
Standards for Processing Aeronautical Data (only for AIS providers)	EUROCAE ED-76A/ RTCA DO-200B	June 2015
Functional safety of electrical/electronic/programmable electronic safety-related systems – Part 3: Software requirements	IEC 61508 – Part 3	April 2010

EUROCAE ED-109A/RTCA DO-278A and EUROCAE ED-12C/RTCA DO-178C make reference to some external documents (supplements), which are integral part of the standard for the use of some particular technologies and development techniques. The supplements are the following:

- (1) Formal Methods Supplement to ED-12C and ED-109A (EUROCAE ED-216/RTCA DO-333)
- (2) Object-Oriented Technology and related Techniques Supplement to ED-12C and ED-109A (EUROCAE ED-217/RTCA DO-332)
- (3) Model-Based Development and Verification Supplement to ED-12C and ED-109A (EUROCAE ED-218/RTCA DO-331)

When tools are used during the software development lifecycle, EUROCAE ED-215/RTCA DO330 'Software Tool Qualification Considerations' may be considered in addition to EUROCAE ED12C RTCA/DO-178C and EUROCAE ED-109A/RTCA DO-278A.

- (c) The definition of the software assurance processes may be based on one of these industrial standards, without combining provisions from different standards as far as the consistency and validation of each of the industrial standards have only been performed at individual level by each specific standardisation group.

GM1 ATM/ANS.OR.C.005(a)(2) Safety support assessment and assurance of changes to the functional system

ED Decision 2017/001/R

SPECIFICATION

'Continue to behave only as specified in the specified context' means that assurance needs to be provided that the monitoring requirements are suitable for demonstrating that the service behaves only as specified in the specified context during operation.

GM2 ATM/ANS.OR.C.005(a)(2) Safety support assessment and assurance of changes to the functional system

ED Decision 2019/022/R

ASSURANCE LEVELS

- (a) The use of assurance level concepts, e.g. design assurance levels (DALs), software assurance levels (SWALs), hardware assurance levels (HWALs), can be helpful in generating an appropriate and sufficient body of evidence to help establish the required confidence in the argument.
- (b) The term 'software assurance level (SWAL)' is understood to be the level of rigour of the software assurances throughout the software lifecycle. In this context, the software life cycle is understood to be:
 - (1) an ordered collection of processes determined by an organisation to be sufficient and adequate to produce a software item;
 - (2) the period of the time that begins with the decision to produce or modify a software item and ends when the item is retired from service.

GM3 ATM/ANS.OR.C.005(a)(2) Safety support assessment and assurance of changes to the functional system

ED Decision 2017/001/R

SAFETY SUPPORT REQUIREMENTS

The complete behaviour is limited to the scope of the change. Safety support requirements only apply to the parts of a system affected by the change. In other words, if parts of a system can be isolated from each other and only some parts are affected by the change, then these are the only parts that are of concern and so will have safety support requirements attached to them.

The following list contains examples, not exhaustive, of safety support requirements that specify:

- (a) for equipment, the complete behaviour, in terms of functions, accuracy, timing, order, format, capacity, resource usage, robustness to abnormal conditions, overload tolerance, availability, reliability, confidence and integrity;
- (b) for people, their performance in terms of tasks (e.g. accuracy, response times, acceptable workload, resilience to distraction, self-awareness, ‘team-playerness’, adaptability, reliability, confidence, skills, and knowledge in relation to their tasks);
- (c) for procedures, the circumstances for their enactment, the resources needed to perform the procedure (i.e. people and equipment), the sequence of actions to be performed and the timing and accuracy of the actions; and
- (d) interactions between all parts of the system.

AMC1 ATM/ANS.OR.C.005(b)(1) Safety support assessment and assurance of changes to the functional system

ED Decision 2017/001/R

VERIFICATION

The service provider other than the air traffic services provider should ensure that verification activities of the safety support assessment process include verification:

- (a) that the full scope of the change is addressed throughout the whole assessment process, i.e. all the elements of the functional system or environment of operation that are changed or affected by the change and those unchanged elements that depend upon them and on which they depend are identified;
- (b) that the way the service behaves complies with and does not contradict any requirements placed on the changed service by another part of the regulations or conditions attached to the providers’ certificate;
- (c) that the specification of the way the service behaves and the safety support requirements are complete and correct;
- (d) that the specification of the operational context is complete and correct;
- (e) that the specification was analysed in the context in which it is intended to operate;
- (f) of the completeness of the argument as per [AMC2 ATM/ANS.OR.C.005\(a\)\(2\)](#);
- (g) that the safety support requirements are correct and complete by reference to the specification; and

- (h) to the intended degree of confidence, that the implementation satisfies the safety support requirements and behaves only as specified in the given operational context.

GM1 ATM/ANS.OR.C.005(b)(1) Safety support assessment and assurance of changes to the functional system

ED Decision 2017/001/R

DESCRIPTION OF THE SCOPE — ‘MULTI-ACTOR CHANGE’

In the case where the change is a ‘multi-actor change’ in reference to [ATM/ANS.OR.A.045\(e\)](#), the interfaces and interactions include the interfaces with the other service providers and/or aviation undertakings that are also affected by the change.

Information related to cooperatively identifying the scope of ‘multi-actor changes’ may be found in EUROCAE ED-78A.

GM2 ATM/ANS.OR.C.005(b)(1) Safety support assessment and assurance of changes to the functional system

ED Decision 2017/001/R

VERIFICATION

This requirement is seeking verification because it is a simple cross-check of available material, i.e. that the specification reflects the requirements of other parts of this Regulation.

- (a) Behaviour

[ATM/ANS.OR.C.005\(b\)\(1\)\(ii\)](#) requires that the service meets its specification. Consequently, the specification must be complete and valid, i.e. it includes the behaviour addressed in [ATM/ANS.OR.C.005\(b\)\(1\)\(iii\)](#) and any additional behaviour in the specified context.

- (b) Compliance with other requirements

- (1) [ATM/ANS.OR.C.005\(b\)\(1\)\(iii\)](#) requires the service providers to identify all parts of this Regulation that impose behaviour on the changed service and also includes any conditions attached to the certificate. They have to identify only those parts of this Regulation that describe required behaviour relevant to the changed service. The identified behaviour shall be included in the specification of the changed service.

Note that the Regulation or conditions attached to the certificate may render compliance with technical standards and ICAO SARPs mandatory.

- (2) Compliance with other non-mandatory standards may also be a necessary condition for other reasons.
- (3) [ATM/ANS.OR.C.005\(b\)\(1\)\(iii\)](#) does not state that the service only meets the requirements of the other parts of this Regulation. It may do other things as well, as described in (5) below.
- (4) In [ATM/ANS.OR.C.005\(b\)\(1\)\(iii\)](#), ‘does not contradict’ is used to express the concern that behaviour beyond that required by a standard might cause the behaviour required by the standard to be undermined.

- (5) The behaviour of a service is likely to include behaviour unspecified in standards; such behaviour may come from:
- (i) the behaviour of degraded modes of operation;
 - (ii) additional behaviour not required by the standard, but put there for commercial purposes, e.g. competitive edge; or
 - (iii) other behaviour identified by the customer, e.g. an air traffic services provider.
- (6) Consequently, the total behaviour should be specified.

AMC1 ATM/ANS.OR.C.005(b)(2) Safety support assessment and assurance of changes to the functional system

ED Decision 2017/001/R

MONITORING

Service providers other than an air traffic services provider should ensure that within the safety support assessment process for a change, the monitoring criteria that are to be used to demonstrate that the safety support case remains valid during the operation of the changed functional system, i.e. that the changed service continues to meet its specification, are identified and documented. These criteria should be such that:

- (a) they indicate that the assumptions made in the safety support case remain valid; and
- (b) if the properties being monitored remain within the bounds set by these criteria, the service will be behaving as specified.

GM1 ATM/ANS.OR.C.005(b)(2) Safety support assessment and assurance of changes to the functional system

ED Decision 2017/001/R

MONITORING OF INTRODUCED CHANGES

- (a) Monitoring is intended to maintain confidence in the safety support argument during operation of the changed functional system. Monitoring is, therefore, only applicable following the entry into service of the change.
- (b) Monitoring is likely to be of internal parameters of the functional system that provide a good indication of the performance of the service. These parameters may not be directly observable at the service level, i.e. at the interface of the service with the operational environment. For example, where a function is provided by multiple redundant resources, the availability of the function will be so high that monitoring it may not be useful. However, monitoring the availability of individual resources, which fail much more often, may be a useful indicator of the performance of the overall function.

SUBPART D — SPECIFIC ORGANISATIONAL REQUIREMENTS FOR ANS AND ATFM PROVIDERS AND THE NETWORK MANAGER (ATM/ANS.OR.D)

ATM/ANS.OR.D.001 Scope

Regulation (EU) 2017/373

This Subpart establishes the requirements to be met by air navigation services (ANS) and air traffic flow management (ATFM) providers and the Network Manager, in addition to the requirements set out in Subparts A, B and C.

ATM/ANS.OR.D.005 Business, annual, and performance plans

Regulation (EU) 2017/373

(a) *Business plan*

- (1) Air navigation services and air traffic flow management providers shall produce a business plan covering a minimum period of five years. The business plan shall:
 - (i) set out the overall aims and goals of the air navigation services and of the air traffic flow management providers, and their strategy towards achieving them in consistency with any overall longer-term plan of the air navigation services provider or of the air traffic flow management provider and with the relevant requirements of Union law for the development of infrastructure or other technology;
 - (ii) contain performance targets in terms of safety, capacity, environment and cost-efficiency, as may be applicable pursuant to Commission Implementing Regulation (EU) No 390/2013¹.
- (2) The information listed in points (i) and (ii) of point (1) shall be aligned with the performance plan referred to in Article 11 of [Regulation \(EC\) No 549/2004](#) and, as far as safety data is concerned, it shall be consistent with the state safety programme referred to in Standard 3.1.1 of Annex 19 to the Chicago Convention in its first edition of July 2013.
- (3) Air navigation services and air traffic flow management providers shall provide safety and business justifications for major investment projects including, where relevant, the estimated impact on the appropriate performance targets referred to in point (1)(ii) and identifying investments stemming from the legal requirements associated with the implementation of the Single European Sky ATM Research Programme (SESAR).

(b) *Annual plan*

- (1) Air navigation services and air traffic flow management providers shall produce an annual plan covering the forthcoming year which shall further specify the features of the business plan and describe any changes to it as compared to the previous plan.

¹ Commission Implementing Regulation (EU) No 390/2013 of 3 May 2013 laying down a performance scheme for air navigation services and network functions (OJ L 128, 9.5.2013, p. 1).

- (2) The annual plan shall cover the following provisions on the level and quality of service, such as the expected level of capacity, safety, environment and cost-efficiency:
- (i) information on the implementation of new infrastructure or other developments, and a statement on how they will contribute to improving the performance of the air navigation services provider or of the air traffic flow management provider, including level and quality of services;
 - (ii) performance indicators, as may be applicable, consistent with the performance plan referred to in Article 11 of [Regulation \(EC\) No 549/2004](#), against which the performance level and quality of service may be reasonably assessed;
 - (iii) information on the measures foreseen to mitigate the safety risks identified by the air navigation services and air traffic flow management provider, including safety indicators to monitor safety risk and, where appropriate, the estimated cost of mitigation measures;
 - (iv) the air navigation services and air traffic flow management providers' expected short-term financial position as well as any changes to or impacts on the business plan.
- (c) *Performance part of the plans*
- The air navigation services and the air traffic flow management providers shall make the content of the performance part of their business plans and of their annual plans available to the Commission on its request, under the conditions set by the competent authority in accordance with national law.

ATM/ANS.OR.D.010 Security management

Regulation (EU) 2017/373

- (a) Air navigation services and air traffic flow management providers and the Network Manager shall, as an integral part of their management system as required in point [ATM/ANS.OR.B.005](#), establish a security management system to ensure:
- (1) the security of their facilities and personnel so as to prevent unlawful interference with the provision of services;
 - (2) the security of operational data they receive, or produce, or otherwise employ, so that access to it is restricted only to those authorised.
- (b) The security management system shall define:
- (1) the procedures relating to security risk assessment and mitigation, security monitoring and improvement, security reviews and lesson dissemination;
 - (2) the means designed to detect security breaches and to alert personnel with appropriate security warnings;
 - (3) the means of controlling the effects of security breaches and to identify recovery action and mitigation procedures to prevent re-occurrence.
- (c) Air navigation services and air traffic flow management providers and the Network Manager shall ensure the security clearance of their personnel, if appropriate, and coordinate with the relevant civil and military authorities to ensure the security of their facilities, personnel and data.

- (d) Air navigation services and air traffic flow management providers and the Network Manager shall take the necessary measures to protect their systems, constituents in use and data and prevent compromising the network against information and cyber security threats which may have an unlawful interference with the provision of their service.

GM1 ATM/ANS.OR.D.010(d) Security management

ED Decision 2017/001/R

INFORMATION SECURITY THREAT

Information security threat may be any circumstance or event with the potential to adversely impact the operation, systems and/or constituents due to human action (accidental, casual or purposeful, intentional or unintentional, mistaken) resulting from unauthorised access, use, disclosure, denial, disruption, modification, or destruction of information and/or information system interfaces. This should include malware and the effects of external systems on dependent systems, but does not include physical threats.

ATM/ANS.OR.D.015 Financial strength — economic and financial capacity

Regulation (EU) 2017/373

Air navigation services and air traffic flow management providers shall be able to meet their financial obligations, such as fixed and variable costs of operation or capital investment costs. They shall use an appropriate cost-accounting system. They shall demonstrate their ability through the annual plan as referred to in point [ATM/ANS.OR.D.005\(b\)](#), as well as through balance sheets and accounts, as applicable under their legal statute, and regularly undergo an independent financial audit.

ATM/ANS.OR.D.020 Liability and insurance cover

Regulation (EU) 2017/373

- (a) Air navigation services and air traffic flow management providers and the Network Manager shall have in place arrangements to cover liabilities related to the execution of their tasks in accordance with the applicable law.
- (b) The method employed to provide the cover shall be appropriate to the potential loss and damage in question, taking into account the legal status of the providers concerned and the Network Manager and the level of commercial insurance cover available.
- (c) Air navigation services and air traffic flow management providers and the Network Manager which avail themselves of services of another service provider shall ensure that the agreements that they conclude to that effect specify the allocation of liability between them.

ATM/ANS.OR.D.025 Reporting requirements

Regulation (EU) 2017/373

- (a) Air navigation services and air traffic flow management providers shall provide an annual report of their activities to the competent authority.
- (b) For air navigation services and air traffic flow management providers, the annual report shall cover their financial results, without prejudice to Article 12 of [Regulation \(EC\) No 550/2004](#), as

well as their operational performance and any other significant activities and developments in particular in the area of safety.

- (c) The Network Manager shall, in accordance with Article 20 of [Regulation \(EU\) No 677/2011](#), provide an annual report of its activities to the Commission and the Agency. This report shall cover its operational performance, as well as significant activities and developments in particular in the area of safety.
- (d) The annual reports referred to in points (a) and (c) shall include as a minimum:
- (1) an assessment of the level of performance of services provided;
 - (2) for air navigation services and air traffic flow management providers, their performance compared to the performance targets established in the business plan referred to in point [ATM/ANS.OR.D.005\(a\)](#), comparing actual performance against the performance set out in the annual plan by using the indicators of performance established in the annual plan;
 - (3) for the Network Manager, its performance compared to the performance objectives established in the Network Strategy Plan referred to in Article 2(24) of [Regulation \(EU\) No 677/2011](#), comparing actual performance against the performance set out in the Network Operational Plan referred to in Article 2(23) of that Regulation by using the indicators of performance established in the Network Operational Plan;
 - (4) an explanation for differences with the relevant targets and objectives and an identification of the measures required to address any gaps between the plans and actual performance, during the reference period referred to in Article 11 of [Regulation \(EC\) No 549/2004](#);
 - (5) developments in operations and infrastructure;
 - (6) the financial results, where they are not published separately in accordance with Article 12(1) of [Regulation \(EC\) No 550/2004](#);
 - (7) information about the formal consultation process with the users of its services;
 - (8) information about the human resources policy.
- (e) Air navigation services and air traffic flow management providers and the Network Manager shall make their annual reports available to the Commission and the Agency on their request. They shall also make those reports available to the public, under the conditions set by the competent authority in accordance with Union and national law.

APPENDICES TO ANNEX III

Appendix 1 AERONAUTICAL DATA CATALOGUE

Regulation (EU) 2020/469

Introduction

- (a) The aeronautical data catalogue is a reference to the aeronautical data subjects, properties and subproperties organised in:
- (1) aerodrome data;
 - (2) airspace data;
 - (3) ATS and other routes data;
 - (4) instrument flight procedure data;
 - (5) radio navigation aids/systems data;

-
- (6) obstacle data;
 - (7) geographical position data.
- (b) The tables of the aeronautical data catalogue are composed of the following columns:
- (1) subject for which data can be collected;
 - (2) property: an identifiable characteristic of a subject which may be further defined into sub-properties;
 - (3) same as 2;
 - (4) types: the data is classified into different types;
 - (5) description: a description of the data item;
 - (6) notes: containing additional information or conditions for the provision of the data;
 - (7) accuracy: requirements for aeronautical data are based on a 95 % confidence level;
 - (8) integrity classification;
 - (9) origination type: data is identified as surveyed, calculated or declared;
 - (10) publication resolution;
 - (11) chart resolution.

Note for items 2 and 3 under point (b): the classification of a catalogue element as subject, property or sub-property does not impose a certain data model.

Note for item 7 under point (b): for those fixes and points that serve a dual purpose, e.g. holding point and missed approach point, the higher accuracy applies. Accuracy requirements for obstacle and terrain data are based on a 90 % confidence level.

Note for item 10 under point (b): the publication resolutions for geographical position data (latitude and longitude) are applicable to coordinates formatted in degrees, minutes, seconds. When a different format is used (such as degrees with decimals for digital data sets) or when the location is significantly further to the north/south, the publication resolution needs to be commensurate with the accuracy requirements.

1. Aerodrome data

Subject	Property	Sub-property	Type	Description	Note	Accuracy	Integrity	Orig. Type	Pub. Res.	Chart Res.
Aerodrome/ Heliport				A defined area on land or water (including any buildings, installations and equipment) intended to be used either wholly or in part for the arrival, departure and surface movement of aircraft.						
	Designator			Designator of the aerodrome/heliport						
		ICAO location indicator	Text	The four-letter ICAO location indicator of the aerodrome/heliport, as listed in ICAO Doc 7910	If any					

Subject	Property	Sub-property	Type	Description	Note	Accuracy	Integrity	Orig. Type	Pub. Res.	Chart Res.
				'Location Indicators'						
		IATA designator	Text	The identifier that is assigned to a location in accordance with IATA rules (Resolution 767)	If any					
		Other	Text	A locally defined airport identifier, if other than an ICAO location indicator						
	Name		Text	The primary official name of an aerodrome as designated by the competent authority						
	Served city		Text	The full name (free text) of the city or town the aerodrome/ heliport is serving						

Subject	Property	Sub-property	Type	Description	Note	Accuracy	Integrity	Orig. Type	Pub. Res.	Chart Res.
	Type of traffic permitted									
		International/national	Code list	Indication if international and/or national flights are permitted at the aerodrome/heliport						
		Instrument flight rules (IFR) / Visual flight rules (VFR)	Code list	Indication if IFR and/or VFR flights are permitted at the aerodrome/heliport						
		Scheduled/non-scheduled	Code list	Indication if scheduled and/or non-scheduled flights are permitted at the aerodrome/heliport						
		Civil/military	Code list	Indication if civil commercial aviation and/or general aviation						

Subject	Property	Sub-property	Type	Description	Note	Accuracy	Integrity	Orig. Type	Pub. Res.	Chart Res.
				and/or military flights are permitted at the aerodrome/heliport						
		Restricted use	Text	Indication if an aerodrome or heliport is not open for the public (only for use by the owners)						
	Heliport type		Text	The type of the heliport (surface level, elevated, shipboard or helideck)						
	Control type		Text	Indication if an aerodrome is under civil control, military control or joint control						
	Certified		Text	Indication if an aerodrome is/is not certified in accordance with the ICAO						

Subject	Property	Sub-property	Type	Description	Note	Accuracy	Integrity	Orig. Type	Pub. Res.	Chart Res.
				rules or Regulation (EU) No 139/2014						
	Certification date		Date	The date when the airport certification was issued by the competent authority						
	Certification expiration date		Date	The date when the aerodrome certification becomes invalid						
	Field elevation									
		Elevation	Elevation	The vertical distance above mean sea level (MSL) from the highest point of the landing area		0.5 m	Essential	Surveyed	1 m or 1 ft	1 m or 1 ft
		Geoid undulation	Height	The geoid undulation at the aerodrome/ heliport elevation position	Where appropriate	0.5 m	Essential	Surveyed	1 m or 1 ft	1 m or 1 ft

Subject	Property	Sub-property	Type	Description	Note	Accuracy	Integrity	Orig. Type	Pub. Res.	Chart Res.
	Reference temperature		Value	The monthly mean of the daily maximum temperatures for the hottest month of the year at an aerodrome; this temperature must be averaged over a period of years.						
	Mean low temperature		Value	The mean lowest temperature of the coldest month of the year, for the last five years of data at the aerodrome elevation		5 degrees				
	Magnetic variation			The angular difference between the true and the magnetic north						

Subject	Property	Sub-property	Type	Description	Note	Accuracy	Integrity	Orig. Type	Pub. Res.	Chart Res.
		Angle	Angle	The angle value of the magnetic variation		1 degree	Essential	Surveyed	1 degree	1 degree
		Date	Date	The date on which the magnetic variation had the corresponding value						
		Annual change	Value	The annual rate of change of the magnetic variation						
	Reference point			The designated geographical location of an aerodrome						
		Position	Point	Geographical location of the aerodrome reference point		30 m	Routine	Surveyed/ calculated	1 sec	1 sec
		Site	Text	Location of the reference point on the aerodrome						

Subject	Property	Sub-property	Type	Description	Note	Accuracy	Integrity	Orig. Type	Pub. Res.	Chart Res.
		Direction	Text	Direction of the aerodrome reference point from the centre of the city or town which the aerodrome serves						
		Distance	Distance	Distance of the aerodrome reference point from the centre of the city or town which the aerodrome serves						
Landing direction indicator				A device to visually indicate the direction currently designated for landing and for take-off						
	Location		Text	Location of the landing direction indicator						

Subject	Property	Sub-property	Type	Description	Note	Accuracy	Integrity	Orig. Type	Pub. Res.	Chart Res.
	Lighting		Text	Lighting of the landing direction indicator	If any					
Secondary power supply										
	Characteristics		Text	Description of the secondary power supply						
	Switch-over time		Value	Secondary power supply switch-over time						
Anemometer				Device used for measuring the wind speed						
	Location		Text	Location of the anemometer						
	Lighting		Text	Lighting of the anemometer	If any					
Aerodrome beacon (ABN) / identification beacon (IBN)				Aerodrome beacon/identification beacon used to indicate the location of an aerodrome from the air						

Subject	Property	Sub-property	Type	Description	Note	Accuracy	Integrity	Orig. Type	Pub. Res.	Chart Res.
	Location		Text	Location of the aerodrome beacon/identification beacon	If any					
	Characteristics		Text	Description of the aerodrome beacon/identification beacon						
	Hours of operation		Schedule	Hours of operation of the aerodrome beacon/identification beacon						
Wind direction indicator										
	Location		Text	Location of the wind direction indicator						
	Lighting		Text	Lighting of the wind direction indicator						
Runway visual range (RVR) observation site				The observation site of the RVR						
	Position		Point	Geographical location of the						

Subject	Property	Sub-property	Type	Description	Note	Accuracy	Integrity	Orig. Type	Pub. Res.	Chart Res.
				RVR observation sites						
Frequency area				The designated part of a surface movement area where a specific frequency is required by ATC or ground control						
	Station		Text	Name of the station providing the service						
	Frequency		Value	Frequency of the station providing the service						
	Boundary		Polygon	Area boundary of the frequency area						
Hot spot				A location on an aerodrome movement area with a history, or potential risk,						

Subject	Property	Sub-property	Type	Description	Note	Accuracy	Integrity	Orig. Type	Pub. Res.	Chart Res.
				of collision or RWY incursion, and where heightened attention by pilots/drivers is necessary						
	Identifier		Text	The identifier of the hot spot						
	Annotation		Text	Additional information about the hot spot						
	Geometry		Polygon	Geographical area of the hot spot						
RWY				A defined rectangular area on a land aerodrome prepared for the landing and take-off of aircraft						
	Designator		Text	The full textual designator of the RWY, used to uniquely						

Subject	Property	Sub-property	Type	Description	Note	Accuracy	Integrity	Orig. Type	Pub. Res.	Chart Res.
				identify the RWY at an aerodrome/heliport (e.g. 09/27, 02R/20L, RWY 1)						
	Nominal length		Distance	The declared longitudinal extent of the RWY for operational (performance) calculations		1 m	Critical	Surveyed	1 m or 1 ft	1 m
	Nominal width		Distance	The declared transversal extent of the RWY for operational (performance) calculations		1 m	Essential	Surveyed	1 m or 1 ft	1 m
	Geometry		Polygon	Geometries of the RWY element, RWY displaced area and RWY intersection						
	Centre line points									

Subject	Property	Sub-property	Type	Description	Note	Accuracy	Integrity	Orig. Type	Pub. Res.	Chart Res.
		Position	Point	Geographical location of the RWY centre line at each end of the RWY, at the stopway (SWY), and at the origin of each take-off flight path area, as well as at each significant change in the slope of the RWY and SWY	Definition from Annex 4 3.8.4.2	1 m	Critical	Surveyed		
		Elevation	Elevation	The elevation of the corresponding centre line point. For non-precision approaches, any significant high and low intermediate		0.25 m	Critical	Surveyed		

Subject	Property	Sub-property	Type	Description	Note	Accuracy	Integrity	Orig. Type	Pub. Res.	Chart Res.
				points along the RWY shall be measured to the accuracy of one-half metre or foot.						
		Geoid undulation	Height	The geoid undulation at the corresponding centre line point						
	RWY exit line									
		Exit guidance line	Line	Geographical location of the RWY exit line		0.5 m	Essential	Surveyed	1/100 sec	1 sec
		Colour	Text	Colour of the RWY exit line						
		Style	Text	Style of the RWY exit line						
		Directionality	Code list	Directionality of the RWY exit line (one-way or two-way)						

Subject	Property	Sub-property	Type	Description	Note	Accuracy	Integrity	Orig. Type	Pub. Res.	Chart Res.
	Surface type		Text	The surface type of the RWY						
	Strength									
		Pavement classification number (PCN)	Text	PCN						
		Pavement type	Text	Pavement type for the aircraft classification number — pavement classification number (ACN-PCN) determination						
		Subgrade category	Text	Subgrade strength category of the RWY						
		Allowable pressure	Text	The maximum allowable tyre pressure category or the maximum allowable tyre						

Subject	Property	Sub-property	Type	Description	Note	Accuracy	Integrity	Orig. Type	Pub. Res.	Chart Res.
				pressure value						
		Evaluation method	Text	The evaluation method used						
	Strip			A defined area including the RWY and the SWY, if provided: to reduce the risk of damage to aircraft running off a RWY; and to protect aircraft flying over the RWY during take-off or landing operations						
		Length	Distance	The longitudinal extent of the RWY strip						
		Width	Distance	The transversal						

Subject	Property	Sub-property	Type	Description	Note	Accuracy	Integrity	Orig. Type	Pub. Res.	Chart Res.
				extent of the RWY strip						
		Surface type	Text	The surface type of the RWY strip						
	Shoulder			An area adjacent to the edge of a pavement, so prepared as to provide a transition area between the pavement and the adjacent surface						
		Geometry	Polygon	Geographical location of the RWY shoulders						
		Surface type	Text	The surface type of the RWY shoulder						
		Width	Distance	The width of the RWY shoulder		1 m	Essential	Surveyed	1 m or 1 ft	
	Blast pad			Specially prepared surface						

Subject	Property	Sub-property	Type	Description	Note	Accuracy	Integrity	Orig. Type	Pub. Res.	Chart Res.
				placed adjacent to the end of a RWY to eliminate the erosive effect of the strong wind forces produced by aeroplanes at the beginning of their take-off roll						
		Geometry	Polygon	Geographical location of the blast pad						
	Obstacle-free zone		Text	Existence of an obstacle-free zone for a precision approach RWY category I	When provided					
	RWY marking									
		Type	Text	Type of the RWY marking						
		Description	Text	Description of the RWY marking						

Subject	Property	Sub-property	Type	Description	Note	Accuracy	Integrity	Orig. Type	Pub. Res.	Chart Res.
		Geometry	Polygon	The geographical location of the RWY marking						
	RWY centre line LGT									
		Length	Distance	The longitudinal extent of the RWY centre line lights						
		Spacing	Distance	Spacing of the RWY centre line lights						
		Colour	Text	Colour of the RWY centre line lights						
		Intensity	Text	Intensity of the RWY centre line lights						
		Position	Point	Geographical location of each individual light of the RWY centre line lights						
	RWY edge LGT									

Subject	Property	Sub-property	Type	Description	Note	Accuracy	Integrity	Orig. Type	Pub. Res.	Chart Res.
		Length	Distance	The longitudinal extent of the RWY edge lights						
		Spacing	Distance	Spacing of the RWY edge lights						
		Colour	Text	Colour of the RWY edge lights						
		Intensity	Text	Intensity of the RWY edge lights						
		Position	Point	Geographical location of each individual light of the RWY edge lights						
	Reference code			The intent of the reference code is to provide a simple method for interrelating the numerous specifications concerning						

Subject	Property	Sub-property	Type	Description	Note	Accuracy	Integrity	Orig. Type	Pub. Res.	Chart Res.
				the characteristics of aerodromes so as to provide a series of aerodrome facilities that are suitable for the aeroplanes intended to operate at the aerodrome.						
		Number	Code list	A number based on the aeroplane reference field length						
		Letter	Code list	A letter based on the aeroplane wingspan and outer main gear wheel span						
	Restriction		Text	Description of restrictions imposed on the RWY						

Subject	Property	Sub-property	Type	Description	Note	Accuracy	Integrity	Orig. Type	Pub. Res.	Chart Res.
RWY direction										
	Designator		Text	The full textual designator of the landing and take-off direction — examples: 27, 35L, 01R						
	True bearing		Bearing	The true bearing of the RWY		1/100 degree	Routine	Surveyed	1/100 degree	1 degree
	Type		Text	Type of RWY: precision (Cat I, II, III)/ non-precision/ non-instrument						
	Threshold			The beginning of the portion of the RWY usable for landing						
		Position	Point	The geographical location of the RWY threshold		1 m	Critical	Surveyed	1/100 sec	1 sec

Subject	Property	Sub-property	Type	Description	Note	Accuracy	Integrity	Orig. Type	Pub. Res.	Chart Res.
		Elevation	Elevation	Elevation of the RWY threshold		See Note 1				
		Geoid undulation	Height	WGS-84 geoid undulation at the RWY threshold position		See Note 2				
		Type	Text	The indication if the threshold is displaced or not displaced; a displaced threshold is not located at the extremity of the RWY						
		Displacement	Distance	Distance of the displaced threshold	If threshold displaced	1 m	Routine	Surveyed		
	RWY end			RWY end (flight path alignment point)						
		Position	Point	Location of the RWY end in the		1 m	Critical	Surveyed	1/100 sec	1 sec

Subject	Property	Sub-property	Type	Description	Note	Accuracy	Integrity	Orig. Type	Pub. Res.	Chart Res.
				direction of departure						
		Elevation	Elevation	Elevation of the end position of the RWY		See RWY centre line points				
	Departure end of RWY (DER)			The end of the area declared suitable for take-off (i.e. the end of the RWY or, where a clearway is provided, the end of the clearway)	Beginning of the departure procedure					
		Position	Point	The geographical location of the DER						
		Elevation	Elevation	The elevation of the DER is the elevation of the end of the RWY or of the clearway,						

Subject	Property	Sub-property	Type	Description	Note	Accuracy	Integrity	Orig. Type	Pub. Res.	Chart Res.
				whichever is higher.						
	Touchdown zone			The portion of a RWY beyond the threshold, where landing aeroplanes are intended to first contact the RWY						
		Elevation	Elevation	The highest elevation of the touchdown zone of a precision approach RWY	Precision approach RWY	0.25 m or 0.25 ft				
		Slope	Value	The slope of the RWY touchdown zone						
	Slope		Value	The slope of the RWY						
	Land-and-hold short operations (LAHSOs)			LAHSOs						
		Geometry	Line	The geographical						

Subject	Property	Sub-property	Type	Description	Note	Accuracy	Integrity	Orig. Type	Pub. Res.	Chart Res.
				location of the LAHSOs						
		Protected element	Text	The name of the RWY or taxiway (TWY) being protected						
	Displaced area			The portion of a RWY between the beginning of the RWY and the displaced threshold						
		Geometry	Polygon	Geographical location of the displaced area						
		PCN	Text	The PCN of the displaced area						
		Surface type	Text	The surface type of the displaced area						
		Aircraft restriction	Text	Usage restriction for a specific aircraft type						

Subject	Property	Sub-property	Type	Description	Note	Accuracy	Integrity	Orig. Type	Pub. Res.	Chart Res.
	SWY			A defined rectangular area on the ground at the end of the take-off RWY available, prepared as a suitable area in which an aircraft may be stopped in case of an abandoned take-off						
		Length	Distance	The longitudinal extent of the SWY	If any	1 m	Critical	Surveyed	1 m or 1 ft	1 m
		Width	Distance	The width of the SWY		1 m	Critical	Surveyed	1 m or 1 ft	1 m
		Geometry	Polygon	Geographical location of the SWY						
		Slope	Value	The slope of the SWY						
		Surface type	Text	The surface type of the SWY						

Subject	Property	Sub-property	Type	Description	Note	Accuracy	Integrity	Orig. Type	Pub. Res.	Chart Res.
	Clearway			A defined rectangular area on the ground or water under the control of the appropriate authority, selected or prepared as a suitable area over which an aeroplane may make a portion of its initial climb to a specified height						
		Length	Distance	The longitudinal extent of the clearway		1 m	Essential	Surveyed	1 m or 1 ft	
		Width	Distance	The transversal extent of the clearway		1 m	Essential	Surveyed	1 m or 1 ft	
		Ground profile		The vertical profile (or slope) of the clearway	If any					

Subject	Property	Sub-property	Type	Description	Note	Accuracy	Integrity	Orig. Type	Pub. Res.	Chart Res.
	RWY end safety area (RESA)			An area symmetrical about the extended RWY centre line and adjacent to the end of the strip, primarily intended to reduce the risk of damage to an aeroplane undershooting or overrunning the RWY						
		Length	Distance	The longitudinal extent of the RESA						
		Width	Distance	The transversal extent of the RESA						
		Longitudinal slope	Value	The longitudinal slope of the RESA						

Subject	Property	Sub-property	Type	Description	Note	Accuracy	Integrity	Orig. Type	Pub. Res.	Chart Res.
		Transversal slope	Value	The transversal slope of the RESA						
	Declared distances									
		Take-off run available (TORA)	Distance	The length of the RWY, declared available and suitable for the ground run of an aeroplane taking off		1 m	Critical	Surveyed	1 m or 1 ft	1 m
		Take-off distance available (TODA)	Distance	The length of the take-off run available plus the length of the clearway, if provided		1 m	Critical	Surveyed	1 m or 1 ft	1 m
		Accelerate-stop distance available (ASDA)	Distance	The length of the take-off run available plus the length of the SWY, if provided		1 m	Critical	Surveyed	1 m or 1 ft	1 m

Subject	Property	Sub-property	Type	Description	Note	Accuracy	Integrity	Orig. Type	Pub. Res.	Chart Res.
		Landing distance available (LDA)	Distance	The length of the RWY, declared available and suitable for the ground run of an aeroplane landing		1 m	Critical	Surveyed	1 m or 1 ft	1 m
		Remarks	Text	Remarks including RWY entry or start point, where alternative reduced distances have been declared						
	RWY end LGT									
		Colour	Text	Colour of the RWY end lights						
		Position	Point	Geographical location of each individual light of the RWY end lights						
	SWY LGT									

Subject	Property	Sub-property	Type	Description	Note	Accuracy	Integrity	Orig. Type	Pub. Res.	Chart Res.
		Length	Distance	The longitudinal extent of the SWY lights						
		Colour	Text	Colour of the SWY lights						
		Position	Point	Geographical location of each individual light of the SWY lights						
	Approach lighting system									
		Type	Text	Classification of the approach lighting system, using as criteria Regulation (EU) No 139/2014 and CS-ADR-DSN, especially CS ADR-DSN.M.625 and CS ADR-DSN.M.626						

Subject	Property	Sub-property	Type	Description	Note	Accuracy	Integrity	Orig. Type	Pub. Res.	Chart Res.
		Length	Distance	The longitudinal extent of the approach lighting system						
		Intensity	Text	A code indicating the relative intensity of the approach lighting system						
		Position	Point	Geographical location of each individual light of the approach lighting system						
	RWY threshold lights									
		Colour	Text	Colour of the RWY threshold lights						
		Wing bar colour	Text	Colour of the RWY threshold wing bars						

Subject	Property	Sub-property	Type	Description	Note	Accuracy	Integrity	Orig. Type	Pub. Res.	Chart Res.
		Position	Point	Geographical location of each individual light of the threshold and wing bar lights						
	Touchdown zone lights									
		Length	Distance	The longitudinal extent of the RWY touchdown zone lights						
		Position	Point	Geographical location of each individual light of the RWY touchdown zone lights						
	Visual-approach slope indicator system									
		Minimum eye height over the	Height	MEHT						

Subject	Property	Sub-property	Type	Description	Note	Accuracy	Integrity	Orig. Type	Pub. Res.	Chart Res.
		threshold (MEHT)								
		Location	Point	Geographical location of the visual-approach slope indicator system						
		Angle	Angle	The nominal-approach slope angle(s)						
		Type	Text	The type of visual approach indicator system (PAPI, A-PAPI. etc.)						
		Displacement angle	Angle	Where the axis of the system is not parallel to the RWY centre line, the angle of and the direction of displacement, i.e. left or right						

Subject	Property	Sub-property	Type	Description	Note	Accuracy	Integrity	Orig. Type	Pub. Res.	Chart Res.
		Displacement direction	Text	Where the axis of the system is not parallel to the RWY centre line, the angle of and the direction of displacement, i.e. left or right						
	Arresting gear		Line	The geographical location of the arresting-gear cable across the RWY						
	Arresting system			High-energy-absorbing material located at the end of a RWY or SWY, designed to be crushed under the weight of an aeroplane as the material						

Subject	Property	Sub-property	Type	Description	Note	Accuracy	Integrity	Orig. Type	Pub. Res.	Chart Res.
				exerts deceleration forces on the aircraft landing gear						
		Geometry	Polygon	Geographical location of the arresting system						
		Setback	Distance	Setback of the arresting system						
		Length	Distance	The longitudinal extent of the arresting system						
		Width	Distance	The transversal extent of the arresting system						
Radio altimeter area										
	Length		Distance	The longitudinal extent of the radio altimeter area						
	Width		Distance	The transversal						

Subject	Property	Sub-property	Type	Description	Note	Accuracy	Integrity	Orig. Type	Pub. Res.	Chart Res.
				extent of the radio altimeter area						
	Geometry		Polygon	Geographical location of the radio altimeter area						
			Note 1	Threshold elevation for RWYs with non-precision approaches		0.5 m	Essential	Surveyed	1 m or 1 ft	1 m or 1 ft
				Threshold elevation for RWYs with precision approaches		0.25 m	Critical	Surveyed	0.1 m or 0.1 ft	0.5 m or 1 ft
			Note 2	WGS-84 geoid undulation at the RWY threshold for non-precision approaches		0.5 m	Essential	Surveyed	1 m or 1 ft	1 m or 1 ft
				WGS-84 geoid undulation at the RWY		0.25 m	Critical	Surveyed	0.1 m or 0.1 ft	0.5 m or 1 ft

Subject	Property	Sub-property	Type	Description	Note	Accuracy	Integrity	Orig. Type	Pub. Res.	Chart Res.
				threshold for precision approaches						
Final-approach and take-off area (FATO)				A defined area over which the final phase of the approach manoeuvre before hover or landing is completed and from which the take-off manoeuvre is commenced; where the FATO is used by helicopters operated in performance class 1, the defined area includes the rejected take-off area available.						
	Threshold point			The beginning of						

Subject	Property	Sub-property	Type	Description	Note	Accuracy	Integrity	Orig. Type	Pub. Res.	Chart Res.
				the portion of the FATO, usable for landing						
		Position	Point	Geographical location of the FATO threshold point		1 m	Critical	Surveyed	1/100 sec	1 sec
		Elevation	Elevation	Elevation of the FATO threshold		See Note 1				
		Geoid undulation	Height	WGS-84 geoid undulation at the FATO threshold position		See Note 2				
	DER			The end of the area declared suitable for take-off (i.e. the end of the RWY or, where a clearway is provided, the end of the clearway or the end of the FATO area)						

Subject	Property	Sub-property	Type	Description	Note	Accuracy	Integrity	Orig. Type	Pub. Res.	Chart Res.
		Position	Point	Geographical location of the DER		1 m	Critical	Surveyed	1/100 sec	1 sec
		Elevation	Elevation	The higher of the elevations of the beginning and of the end of the RWY/FATO						
	Type		Text	Type of FATO						
	Designation		Text	The full textual designator of the landing and take-off area						
	Length		Distance	The longitudinal extent of FATO		1 m	Critical	Surveyed	1 m or 1 ft	1 m
	Width		Distance	The transversal extent of FATO						
	Geometry		Polygon	Geographical location of the FATO element						
	Slope		Value	The slope of FATO						

Subject	Property	Sub-property	Type	Description	Note	Accuracy	Integrity	Orig. Type	Pub. Res.	Chart Res.
	Surface type		Text	The surface type of FATO						
	True bearing		Bearing	The true bearing of FATO		1/100 degree	Routine	Surveyed	1/100 degree	
	Declared distances									
		Take-off distance available (TODAH)	Distance	The FATO length plus the helicopter clearway length (if provided)	And, if applicable, alternative reduced declared distances	1 m	Critical	Surveyed	1 m or 1 ft	
		Rejected take-off distance available (RTODAH)	Distance	The length of FATO, declared available and suitable for helicopters operated in performance class 1, to complete a rejected take-off		1 m	Critical	Surveyed	1 m or 1 ft	
		Landing distance available (LDAH)	Distance	The length of FATO plus any additional area declared		1 m	Critical	Surveyed	1 m or 1 ft	

Subject	Property	Sub-property	Type	Description	Note	Accuracy	Integrity	Orig. Type	Pub. Res.	Chart Res.
				available and suitable for helicopters to complete the landing manoeuvre from a defined height						
		Remarks	Text	Remarks including RWY entry or start point, where alternative reduced distances have been declared						
	FATO marking									
		Description	Text	Description of the FATO markings						
	Approach lighting system									
		Type	Text	Classification of the approach lighting system,						

Subject	Property	Sub-property	Type	Description	Note	Accuracy	Integrity	Orig. Type	Pub. Res.	Chart Res.
				using as criteria Regulation (EU) No 139/2014 and CS-ADR-DSN, specifically CS ADR-DSN.M.625 and CS ADR-DSN.M.626						
		Length	Distance	The longitudinal extent of the approach lighting system						
		Intensity	Text	A code indicating the relative intensity of the approach lighting system						
		Position	Point	Geographical location of each individual light of the approach						

Subject	Property	Sub-property	Type	Description	Note	Accuracy	Integrity	Orig. Type	Pub. Res.	Chart Res.
				lighting system						
	Area lights									
		Description	Text	Description of the area lights						
		Position	Point	Geographical location of each individual light of the area lights						
	Aiming point lights									
		Description	Text	Description of the aiming point lights						
		Position	Point	Geographical location of each individual light of the aiming point lights						
Touchdown and lift-off area (TLOF)				An area on which a helicopter may touch down or lift off						
	Designator		Text	The full textual						

Subject	Property	Sub-property	Type	Description	Note	Accuracy	Integrity	Orig. Type	Pub. Res.	Chart Res.
				designator of TLOF						
	Centre point									
		Position	Point	Geographical location of the TLOF threshold point		1 m	Critical	Surveyed	1/100 sec	1 sec
		Elevation	Elevation	Elevation of the TLOF threshold		See Note 1				
		Geoid undulation	Height	The WGS-84 geoid undulation TLOF centre point position		See Note 2				
	Length		Distance	The longitudinal extent of TLOF		1 m	Critical	Surveyed	1 m or 1 ft	1 m
	Width		Distance	The transversal extent of TLOF		1 m	Critical	Surveyed	1 m or 1 ft	1 m
	Geometry		Polygon	The geographical location of the TLOF element						
	Slope		Value	The slope of TLOF						

Subject	Property	Sub-property	Type	Description	Note	Accuracy	Integrity	Orig. Type	Pub. Res.	Chart Res.
	Surface type		Text	The surface type of TLOF						
	Bearing strength		Value	The bearing strength of TLOF					1 ton	
	Visual-approach slope indicator system type		Text	Type of the visual-approach slope indicator system						
	Marking									
		Description	Text	Description of the TLOF markings						
Safety area				A defined area on a heliport surrounding the FATO, which is free of obstacles, other than those required for air navigation purposes, and intended to reduce the risk of damage to						

Subject	Property	Sub-property	Type	Description	Note	Accuracy	Integrity	Orig. Type	Pub. Res.	Chart Res.
				helicopters accidentally diverging from the FATO						
	Length		Distance	The longitudinal extent of the safety area						
	Width		Distance	The transversal extent of the safety area						
	Surface type		Text	The surface type of the safety area						
Helicopter clearway				A defined area on the ground or water, selected and/or prepared as a suitable area over which a helicopter operated in performance class 1 may accelerate and achieve						

Subject	Property	Sub-property	Type	Description	Note	Accuracy	Integrity	Orig. Type	Pub. Res.	Chart Res.
				a specific height						
	Length		Distance	The longitudinal extent of the helicopter clearway						
	Ground profile		Value	The vertical profile (or slope) of the helicopter clearway						
			Note 1	The FATO threshold for heliports with or without a Point-in-Space (PinS) approach		0.5 m	Essential	Surveyed	1 m or 1 ft	
				The FATO threshold for heliports intended to be operated		0.25 m	Critical	Surveyed	1 m or 1 ft (non-precision) 0.1 m or 0.1 ft (precision)	
			Note 2	The WGS–84 geoid undulation at the FATO threshold and the		0.5 m	Essential	Surveyed	1 m or 1 ft	

Subject	Property	Sub-property	Type	Description	Note	Accuracy	Integrity	Orig. Type	Pub. Res.	Chart Res.
				TLOF geometric centre, for heliports with or without a PinS approach						
				The WGS–84 geoid undulation at the FATO threshold and the TLOF geometric centre, for heliports intended to be operated		0.25 m	Critical	Surveyed	1 m or 1 ft (non-precision) 0.1 m or 0.1 ft (precision)	
Apron				A defined area on a land aerodrome, intended to accommodate aircraft as regards loading or unloading passengers, mail or cargo,						

Subject	Property	Sub-property	Type	Description	Note	Accuracy	Integrity	Orig. Type	Pub. Res.	Chart Res.
				fuelling, parking or maintenanc e						
	Designator		Text	The full textual name or designator used to identify an apron at an aerodrome/ heliport						
	Geometry		Polygon	Geographica l location of the apron element		1 m	Routine	Surveyed	1/10 sec	1 sec
	Type		Text	Classificatio n of the primary use of the apron						
	Aircraft restriction		Text	Usage restriction (prohibition) for a specified aircraft type						
	Surface type		Text	The surface type of the apron						
	Strength									
		PCN	Text	PCN of the apron						

Subject	Property	Sub-property	Type	Description	Note	Accuracy	Integrity	Orig. Type	Pub. Res.	Chart Res.
		Pavement type	Text	ACN-PCN determination						
		Subgrade category	Text	Subgrade strength category of the apron						
		Allowable pressure	Text	The maximum allowable tyre pressure category or the maximum allowable tyre pressure value						
		Evaluation method	Text	The evaluation method used to determine the apron strength						
	Elevation		Elevation	The elevation of the apron						
TWY				A defined path on a land aerodrome,						

Subject	Property	Sub-property	Type	Description	Note	Accuracy	Integrity	Orig. Type	Pub. Res.	Chart Res.
				established for the taxiing of aircraft and intended to provide a link between one part of the aerodrome and another						
	Designator		Text	The full textual designator of the TWY						
	Width		Distance	The transversal extent of the TWY		1 m	Essential	Surveyed	1 m or 1 ft	
	Geometry		Polygon	Geographical location of the TWY element						
	Bridge		Text	Type of the bridge (none, overpass, underpass)						
	Surface type		Text	Surface type of the TWY						
	Strength									

Subject	Property	Sub-property	Type	Description	Note	Accuracy	Integrity	Orig. Type	Pub. Res.	Chart Res.
		PCN	Text	PCN of the TWY						
		Pavement type	Text	ACN-PCN determination						
		Subgrade category	Text	Subgrade strength category of the TWY						
		Allowable pressure	Text	Maximum allowable tyre pressure category or maximum allowable tyre pressure value						
		Evaluation method	Text	The evaluation method used to determine the taxiway strength						
	Aircraft restrictions		Text	Usage restriction (prohibition) for a specified aircraft type						

Subject	Property	Sub-property	Type	Description	Note	Accuracy	Integrity	Orig. Type	Pub. Res.	Chart Res.
	Reference code letter		Code list	A letter based on the aeroplane wingspan and outer main gear wheel span						
	Location for wing tips extension		Point/Polygon	For aerodromes accommodating aeroplanes with folding wing tips, the location where to extend the wing tips						
	Centre line points									
		Position	Point	Geographical coordinates of the TWY centre line points		0.5 m	Essential	Surveyed	1/100 sec	1/100 sec
		Elevation	Elevation	Elevation of taxiway centre line points		1 m	Essential	Surveyed		
	Shoulder			An area adjacent to the edge of a pavement,						

Subject	Property	Sub-property	Type	Description	Note	Accuracy	Integrity	Orig. Type	Pub. Res.	Chart Res.
				so prepared as to provide a transition between the pavement and the adjacent surface						
		Geometry	Polygon	The geographical location of the TWY shoulder						
		Surface type	Text	Surface type of the TWY shoulder						
		Width	Distance	The width of the TWY shoulder		1 m	Essential	Surveyed	1 m or 1 ft	
	Guidance lines									
		Geometry	Line	Geographical location of the guidance lines		0.5 m	Essential	Surveyed	1/100 sec	1/100 sec
		Colour	Text	Colour of TWY guidance lines						
		Style	Text	Style of TWY guidance lines						
		Wingspan	Value	Wingspan						

Subject	Property	Sub-property	Type	Description	Note	Accuracy	Integrity	Orig. Type	Pub. Res.	Chart Res.
		Maximum speed	Value	Maximum speed						
		Direction	Text	Direction						
	Intermediate holding-position marking line		Line	Intermediate holding position marking line		0.5 m	Essential	Surveyed	1/100 sec	1 sec
	TWY marking									
		Description	Text	Description of the TWY marking						
	TWY edge lights									
		Description	Text	Description of the TWY edge lights						
		Position	Point	Geographical location of each individual light of the TWY edge lights						
	TWY centre line lights									
		Description	Text	Description of the TWY centre line lights						
		Position	Point	Geographical location of each						

Subject	Property	Sub-property	Type	Description	Note	Accuracy	Integrity	Orig. Type	Pub. Res.	Chart Res.
				individual light of the TWY centre line lights						
	Stop bars									
		Description	Text	Description of the stop bars	If any					
		Location	Line	Location of the stop bars						
	RWY guard lights									
		Description	Text	Description of the RWY guard lights and other RWY protection measures	If any					
		Location	Point	Location of the stop bar	Configuration A					
		Location	Line	Location of the stop bar	Configuration B					
	RWY holding position			A designated position intended to protect a RWY, an obstacle limitation surface, or an						

Subject	Property	Sub-property	Type	Description	Note	Accuracy	Integrity	Orig. Type	Pub. Res.	Chart Res.
				instrument landing system (ILS)/microwave landing system (MLS) critical/sensitive area, at which taxiing aircraft and vehicles shall stop and hold, unless otherwise authorised by the aerodrome control tower						
		Geometry	Line	Geographical location of the RWY holding position		0.5 m	Essential	Surveyed	1/100 sec	1 sec
		Protected RWY	Text	Designator of the RWY protected						
		Cat stop	Code list	Category (CAT) of the						

Subject	Property	Sub-property	Type	Description	Note	Accuracy	Integrity	Orig. Type	Pub. Res.	Chart Res.
				RWY (0, I, II, III)						
		RWY ahead text	Text	Actual text as in the marking; e.g. 'RWY AHEAD' or 'RUNWAY AHEAD'						
	Intermediate holding position	Geometry	Line	Geographical location of the intermediate holding position — a designated position intended for traffic control, at which taxiing aircraft and vehicles shall stop and hold until further cleared to proceed, when so instructed by the aerodrome						

Subject	Property	Sub-property	Type	Description	Note	Accuracy	Integrity	Orig. Type	Pub. Res.	Chart Res.
				control tower						
Helicopter ground TWY				A ground TWY intended for the ground movement of wheeled undercarriage helicopters						
	Designator		Text	The full textual designator of the helicopter ground TWY						
	Centre line points		Point	Geographical location of the helicopter ground centre line TWY points		0.5 m	Essential	Surveyed/calculated		
	Elevation		Elevation	Elevation of the helicopter ground TWY		1 m	Essential	Surveyed		
	Width		Distance	The transversal extent of the		1 m	Essential	Surveyed		

Subject	Property	Sub-property	Type	Description	Note	Accuracy	Integrity	Orig. Type	Pub. Res.	Chart Res.
				helicopter ground TWY						
	Surface type		Text	The surface type of the helicopter ground TWY						
	Intersection marking line		Line	Helicopter ground TWY intersection marking line		0.5 m	Essential	Surveyed	1/100 sec	1 sec
	Lighting									
		Description	Text	Description of the helicopter ground TWY light						
		Position	Point	Geographical location of each individual light of the helicopter ground TWY lights						
	Marking									
		Description	Text	Description of helicopter ground TWY marking						
Helicopter air TWY				A defined path on the surface, established						

Subject	Property	Sub-property	Type	Description	Note	Accuracy	Integrity	Orig. Type	Pub. Res.	Chart Res.
				for the air taxiing of helicopters						
	Designator			The full textual designator of the helicopter air TWY						
	Centre line points		Point	Geographical location of the helicopter air TWY centre line points		0.5 m	Essential	Surveyed/calculated		
	Elevation		Elevation	Elevation of the helicopter air TWY		1 m	Essential	Surveyed		
	Width		Distance	The transversal extent of the helicopter air TWY		1 m	Essential	Surveyed		
	Surface type		Text	Surface type of the helicopter air TWY						
	Lighting									
		Description	Text	Description of the helicopter						

Subject	Property	Sub-property	Type	Description	Note	Accuracy	Integrity	Orig. Type	Pub. Res.	Chart Res.
				air TWY lighting						
		Position	Point	Geographical location of each individual light of the helicopter air TWY lights						
	Marking									
		Description	Text	Description of the helicopter air TWY marking						
Helicopter air transit routes				A defined path established for the movement of helicopters from one part of a heliport to another; a taxiing route includes a helicopter air or ground TWY centred on						

Subject	Property	Sub-property	Type	Description	Note	Accuracy	Integrity	Orig. Type	Pub. Res.	Chart Res.
				the taxiing route.						
	Designator		Text	Designator of the helicopter air transit route						
	Geometry		Line	Geographical location of the helicopter air transit route						
	Width		Distance	The transversal extent of the helicopter air transit route		1 m	Essential	Surveyed		
INS checkpoint										
	Location		Point	Geographical location of the INS checkpoint	Where available	0.5 m	Routine	Surveyed	1/100 sec	1/100 sec
Very-high-frequency (VHF) omnidirectional range (VOR) checkpoint										

Subject	Property	Sub-property	Type	Description	Note	Accuracy	Integrity	Orig. Type	Pub. Res.	Chart Res.
	Location		Point	Geographical location of the VOR checkpoint	Where available					
	Frequency		Value	Frequency of the VOR checkpoint						
Altimeter checkpoint										
	Location		Point	Geographical location of the altimeter checkpoints						
	Elevation		Elevation	Elevation of the altimeter checkpoints						
Aircraft stand				A designated area on an apron intended to be used for parking an aircraft						
	Name		Text	Name of the aircraft stand point						
	Aircraft stand points	Location	Point	Geographical location of the aircraft stand point		0.5 m	Routine	Surveyed	1/100 sec	1/100 sec

Subject	Property	Sub-property	Type	Description	Note	Accuracy	Integrity	Orig. Type	Pub. Res.	Chart Res.
		Aircraft types	Code list	Aircraft types						
	Identification sign		Text	Description of the aircraft stand identification sign						
	Visual docking/parking guidance system		Text	Description of the visual docking/parking guidance system at the aircraft stand						
	Parking-stand area		Polygon	Geographical location of the parking-stand area						
	Jetway		Code list	Jetway available at the aircraft stand						
	Fuel		Code list	Fuel available at the aircraft stand						
	Ground power		Code list	Ground power available at the aircraft stand						

Subject	Property	Sub-property	Type	Description	Note	Accuracy	Integrity	Orig. Type	Pub. Res.	Chart Res.
	Towing		Code list	Towing available at the aircraft stand						
	Terminal		Text	Terminal-building reference						
	Surface type		Text	Surface type of the aircraft stand						
	Aircraft restriction		Text	Usage restriction (prohibition) for a specified aircraft type						
	PCN		Text	PCN of the aircraft stand						
	Stand guidance line									
		Geometry	Line	Geographical location of the stand guidance line		0.5 m	Essential	Surveyed		
		Elevation	Elevation	Elevation of the parking guidance line points		1 m	Essential	Surveyed	1/100 sec	

Subject	Property	Sub-property	Type	Description	Note	Accuracy	Integrity	Orig. Type	Pub. Res.	Chart Res.
		Direction	Text	Direction of the stand guidance line						
		Wingspan	Value	Wingspan						
		Colour	Code list	Colour of the stand guidance line						
		Style	Code list	Style of the stand guidance line						
Helicopter stand				An aircraft stand that provides for parking a helicopter, and where ground taxi operations are completed, or where the helicopter touches down and lifts off for air taxiing operations.						
	Name		Text	Name of the helicopter stand						

Subject	Property	Sub-property	Type	Description	Note	Accuracy	Integrity	Orig. Type	Pub. Res.	Chart Res.
	Location		Point	Geographical location of the helicopter stand point/INS checkpoints		0.5 m	Essential	Surveyed	1/100 sec	
De-icing area				A facility where frost, ice or snow is removed (de-icing) from the aeroplane to provide clean surfaces, and/or where clean surfaces of the aeroplane receive protection (anti-icing) against the formation of frost or ice, and accumulation of snow or slush, for a limited						

Subject	Property	Sub-property	Type	Description	Note	Accuracy	Integrity	Orig. Type	Pub. Res.	Chart Res.
				period of time						
	Identifier		Text	Identifier of the de-icing area						
	Geometry		Polygon	Geographical location of the de-icing area		1 m	Routine	Surveyed	1/10 sec	1 sec
	Surface type		Text	The surface type of the de-icing area						
	Id base		Text	Name of the underlying TWY, parking stand or apron element						
	Aircraft restriction		Text	Usage restriction (prohibition) for a specified aircraft type						
Communication facility										
	Service designation		Text	Designation of the service provided						

Subject	Property	Sub-property	Type	Description	Note	Accuracy	Integrity	Orig. Type	Pub. Res.	Chart Res.
	Call sign		Text	Call sign of the communication facility						
	Channel		Text	Channel/frequency of the communication facility						
	Logon address		Text	Logon address of the facility	As appropriate					
	Hours of operation		Schedule	Operational hours of the station serving the unit						

2. Airspace data

Subject	Property	Sub-property	Type	Description	Note	Accuracy	Integrity	Orig. Type	Pub. Res.	Chart Res.
ATS airspace				Airspace of defined dimensions, alpha-betically designated, within which specific types of flights may operate, and for which ATS and air traffic rules of operation are specified						
	Type		Text	Type of ATS airspace in accordance with Appendix 4 to Implementing Regulation (EU) No 923/2012 (SERA)						
	Designation		Text	The designator given to the airspace by a responsible authority						
	Lateral limits		Polygon	The surface defining the horizontal shape of the airspace		See Note 1				
	Vertical limits									
		Upper limit	Altitude	The upper limit of the airspace						
		Lower limit	Altitude	The lower limit of the airspace		50 m	Routine	Calculated	50 m or 100 ft	50 m or 100 ft
	Class of airspace		Code list	A categorisation of airspace which determines the operating rules, flight requirements and services provided.						

Subject	Property	Sub-property	Type	Description	Note	Accuracy	Integrity	Orig. Type	Pub. Res.	Chart Res.
	Transition altitude		Altitude	The altitude at or below which the vertical position of aircraft is controlled by reference to altitudes						
	Hours of applicability		Schedule	The hours of applicability of the airspace						
	ATS unit			Unit providing service						
		Name	Text	The name of the unit providing the service						
		Call sign	Text	The call sign of the aeronautical station serving the unit						
		Language	Code list	Information on the language(s) used, specifying area and conditions, as well as when and where to be used, if applicable						
		Applicability	Text	Information on the area and conditions when to be used						
		Hours of service	Schedule	Operational hours of the station serving the unit						
	Frequency									

Subject	Property	Sub-property	Type	Description	Note	Accuracy	Integrity	Orig. Type	Pub. Res.	Chart Res.
		Value	Value	The frequency of the ATS airspace						
		Purpose	Text	Indications for specific purposes of the frequency						
			Note 1	FIR, UIR		2 km	Routine	Declared	1 min	As plotted
				TMA, CTA		100 m	Essential	Calculated	1 sec	As plotted
				Controlled traffic region (CTR)		100 m	Essential	Calculated	1 sec	As plotted

Subject	Property	Sub-property	Type	Description	Note	Accuracy	Integrity	Orig. Type	Pub. Res.	Chart Res.
Special-activity air space										
	Type		Code list	Type of the special-activity airspace (see Note 1)						
	Identification		Text	The identification given to uniquely identify the airspace						

Subject	Property	Sub-property	Type	Description	Note	Accuracy	Integrity	Orig. Type	Pub. Res.	Chart Res.
	Name		Text	The name given to the airspace by an authority nominated by the Member State						
	Lateral limits		Polygon	The surface defining the horizontal shape of the airspace		See Note 2 for P, R, and D areas only				
	Vertical limits									
		Upper limit	Altitude	The upper limit of the airspace						
		Lower limit	Altitude	The lower limit of the airspace						
	Restriction		Text	Type of restriction or nature of hazard						
	Activation		Text	Information on system and means of activation announcements together with information pertinent to civil flights and applicable to air defence identification zone (ADIZ) procedures						
	Time of activity		Schedule	Time interval when the special activity takes place						

Subject	Property	Sub-property	Type	Description	Note	Accuracy	Integrity	Orig. Type	Pub. Res.	Chart Res.
	Risk of interception		Text	Risk of interception in the event of penetration						
			Note 1 type	Prohibited area	Note 2	100 m	Essential	Calculated	1 sec	As plotted
				Restricted area		2 km	Routine	Declared	1 min	As plotted
				Danger area						
				Military exercise area						
				Military training area						
				ADIZ						
				Other						
Other regulated air-space										

Subject	Property	Sub-property	Type	Description	Note	Accuracy	Integrity	Orig. Type	Pub. Res.	Chart Res.
	Type		Text	Type of airspace (reduced vertical separation minima (RVSM), emergency locator transmitter (ELT), etc.)						
	Identification		Text	The identification given to uniquely identify the airspace						
	Name		Text	The name given to the airspace by an authority nominated by the Member State						
	Lateral limits		Polygon	The surface defining the horizontal shape of the airspace						
	Vertical limits									
		Upper limit	Altitude	The upper limit of the airspace						
		Lower limit	Altitude	The lower limit of the airspace						
	Restriction		Text	Type of restriction, if any						
	Activation		Text	Information on system and means of activation announcements together with information pertinent to civil flights and applicable to ADIZ procedures						

Subject	Property	Sub-property	Type	Description	Note	Accuracy	Integrity	Orig. Type	Pub. Res.	Chart Res.
	Time of activity		Schedule	Time interval when the special activity takes place						
ATS control sector										
	Identification		Text	The identification given to the sector						
	Lateral limits		Polygon	The surface defining the horizontal shape of the ATC sector						
	Vertical limits									
		Upper limit	Altitude	The upper limit of the sector						
		Lower limit	Altitude	The lower limit of the sector						

3. ATS and other routes data

Subject	Property	Sub-property	Type	Description	Note	Accuracy	Integrity	Orig. Type	Pub. Res.	Chart Res.
ATS route				A specified route designed for channeling the flow of traffic as necessary for the provision of ATS						
	Designator		Text	Designators for ATS routes in accordance with Annex XI (Part-FPD) to this Regulation						
	Designator prefix		Text	The prefix of the route designator as specified in Note 1						
Other route				A specified route designed for channeling the flow of traffic as						

Subject	Property	Sub-property	Type	Description	Note	Accuracy	Integrity	Orig. Type	Pub. Res.	Chart Res.
				necessary without provision of ATS						
	Designator		Text	Designator of the route						
	Type		Text	Type of route (e.g. VFR uncontrolled navigation routes)						
	Flight rules		Code list	Information on the flight rules that apply to the route (IFR/VFR)						
Route segment										
	From point			Reference to the first point of a route segment						
		Name	Text	The coded designators or code names of a significant point						
		Reporting	Code list	Indication of the						

Subject	Property	Sub-property	Type	Description	Note	Accuracy	Integrity	Orig. Type	Pub. Res.	Chart Res.
				ATS/MET reporting requirement as 'compulsory' or 'on request'						
	To point			Reference to the second point of a route segment						
		Name	Text	The coded designators or code names of a significant point						
		Reporting	Code list	Indication of the ATS/MET reporting requirement as 'compulsory' or 'on request'						
	Track		Bearing	Track, VOR radial or magnetic bearing of a route segment		1/10 degree (terminal arrival departure)	Routine (terminal arrival departure)	Calculated (terminal arrival departure)	1 degree (terminal arrival departure)	1 degree (terminal arrival departure)

Subject	Property	Sub-property	Type	Description	Note	Accuracy	Integrity	Orig. Type	Pub. Res.	Chart Res.
	Change over point		Point	The point at which an aircraft navigating on an ATS route segment defined by reference to the VOR ranges is expected to transfer its primary navigation reference from the facility behind it to the next facility ahead of it	In case of a VOR radial					
	Length		Distance	The geodesic distance between 'from point' and 'to point'		See Note 2				
	Upper limit		Altitude	The upper limit of the route segment						

Subject	Property	Sub-property	Type	Description	Note	Accuracy	Integrity	Orig. Type	Pub. Res.	Chart Res.
	Lower limit		Altitude	The lower limit of the route segment						
	Minimum en-route altitude (MEA)		Altitude	It is the altitude of an en-route segment that provides adequate reception of relevant navigation facilities and ATS communications, complies with the airspace structure, and provides the required obstacle clearance.		50 m	Routine	Calculated	50 m or 100 ft	50 m or 100 ft
	Minimum obstacle clearance altitude (MOCA)		Altitude	It is the minimum altitude of a defined segment that provides the		50 m	Routine	Calculated	50 m or 100 ft	50 m or 100 ft

Subject	Property	Sub-property	Type	Description	Note	Accuracy	Integrity	Orig. Type	Pub. Res.	Chart Res.
				required obstacle clearance						
	Minimum flight altitude		Altitude	Minimum flight altitude		50 m	Routine	Calculated	50 m or 100 ft	50 m or 100 ft
	Lateral limits		Distance	Lateral limits of the route						
	Area minimum altitude (AMA)		Altitude	It is the minimum altitude to be used under instrument meteorological conditions (IMC), which provides a minimum obstacle clearance within a specified area, normally formed by parallels and meridians.						
	Minimum vectoring altitude (MVA)		Altitude	MVA						

Subject	Property	Sub-property	Type	Description	Note	Accuracy	Integrity	Orig. Type	Pub. Res.	Chart Res.
	Restrictions		Text	Indication on any area speed and level/altitude restrictions, where established						
	Direction of cruising levels			Indication of the direction of the cruising level (even, odd, none (NIL))						
		Forward	Code list	Indication of the direction of the cruising level (even, odd, NIL) from the first point to the second point of the route segment						
		Backward	Code list	Indication of the direction of the cruising level (even, odd, NIL) from the second point to the						

Subject	Property	Sub-property	Type	Description	Note	Accuracy	Integrity	Orig. Type	Pub. Res.	Chart Res.
				first point of the route segment						
	Availability		Text	Information on the route availability						
	Class of airspace		Text	Classification of airspace which determines the operating rules, flight requirements and services provided						
	Performance-based navigation (PBN) requirements			Area navigation based on PBN requirements for aircraft operating along an ATS route, on an instrument approach procedure, or in a designated airspace	PBN only					

Subject	Property	Sub-property	Type	Description	Note	Accuracy	Integrity	Orig. Type	Pub. Res.	Chart Res.
		Navigation specification (s)	Text	<p>Designation of the navigation specification (s) applicable to a specified segment or segments; there are two kinds of navigation specifications:</p> <p>(a) required navigation performance (RNP) specification : navigation specification based on area navigation that includes the requirement for performance monitoring and alerting, designated</p>						

Subject	Property	Sub-property	Type	Description	Note	Accuracy	Integrity	Orig. Type	Pub. Res.	Chart Res.
				<p>by the prefix RNP, e.g. RNP 4, RNP APCH.</p> <p>(b) Area navigation (RNAV) specification : navigation specification based on area navigation that does not include the requirement for performance monitoring and alerting, designated by the prefix RNAV, e.g. RNAV 5, RNAV 1.</p>						
		Navigation performance requirements	Text	The navigation accuracy requirement for each PBN (RNAV or						

Subject	Property	Sub-property	Type	Description	Note	Accuracy	Integrity	Orig. Type	Pub. Res.	Chart Res.
				RNP) route segment						
		Sensor requirements	Text	Indication of the sensor requirements including any navigation specification limitations						
	Controlling unit									
		Name	Text	Name of the unit providing the service						
		Channel	Text	Operating channel/frequency of the controlling unit						
		Logon address	Text	A specified code used for data link logon to the controlling ATS unit	If applicable					
			Note 1	U = upper	Note 2	1/10 km	Routine	Calculated	1/10 km or 1/10 nm	1 km or 1 nm
				H = helicopter		1/100 km	Essential	Calculated	1/100 km or 1/100 nm	1 km or 1 nm

Subject	Property	Sub-property	Type	Description	Note	Accuracy	Integrity	Orig. Type	Pub. Res.	Chart Res.
				S = supersonic						
				T = tacan						
				Other						

Subject	Property	Sub-property	Type	Description	Note	Accuracy	Integrity	Orig. Type	Pub. Res.	Chart Res.
Waypoint										
	Identification		Text	Names, coded designators or code names given to the significant point						
	Position		Point	Geographical location of the waypoint		100 m	Essential	Surveyed/calculated	1 sec	1 sec
	Formation									
		Navigation aid (navaid)	Text	The station identification of the VOR/DME reference						
		Bearing	Bearing	The bearing to the VOR/DME reference if the waypoint is		See Note 1 below				

Subject	Property	Sub-property	Type	Description	Note	Accuracy	Integrity	Orig. Type	Pub. Res.	Chart Res.
				not collocated with it						
		Distance	Distance	The distance from the VOR/DME reference if the waypoint is not collocated with it						
					Note 1	1/10 degree	Routine	Calculated	1/10 degree	1/10 degree
						1/100 degree	Essential	Calculated	1/100 degree	1/10 degree
								Calculated		
					Note 2	1/10 km	Routine	Calculated	1/10 km or 1/10 nm	2/10 km (1/10 nm)
						1/100 km	Essential	Calculated	1/100 km or 1/100 nm	2/10 km (1/10 nm)

Subject	Property	Sub-property	Type	Description	Note	Accuracy	Integrity	Orig. Type	Pub. Res.	Chart Res.
En-route holding				A predetermined manoeuvre that keeps the aircraft						

Subject	Property	Sub-property	Type	Description	Note	Accuracy	Integrity	Orig. Type	Pub. Res.	Chart Res.
				within the specified airspace while awaiting further clearance						
	Identification		Text	Identification of the holding procedure						
	Fix		Text	Identification of the holding-procedure fix		100 m	Essential	Surveyed/calculated	1 sec	1 sec
	Waypoint		Point	Geographical location of the holding waypoint						
	Inbound track		Bearing	The inbound track of the holding procedure						
	Turn direction		Text	Direction of the procedure turn						
	Speed		Value	Maximum indicated airspeed						
	Level									

Subject	Property	Sub-property	Type	Description	Note	Accuracy	Integrity	Orig. Type	Pub. Res.	Chart Res.
		Minimum holding level	Altitude	Minimum holding level of the holding procedure						
		Maximum holding level	Altitude	Maximum holding level of the holding procedure						
	Outbound time/distance		Value	Time/distance value of the holding procedure						
	Controlling unit									
		Name	Text	Indication of the controlling unit						
		Frequency	Value	The operating frequency/channel of the controlling unit						

Subject	Property	Sub-property	Type	Description	Note	Accuracy	Integrity	Orig. Type	Pub. Res.	Chart Res.
	Special holding entry procedure		Text	Textual description of the special VOR/DME entry procedure	In case an entry radial to a secondary fix at the end of the outbound leg has been established for a VOR/DME holding pattern					

4. Instrument flight procedure data

Subject	Property	Sub-property	Type	Description	Note	Accuracy	Integrity	Orig. Type	Pub. Res.	Chart Res.
Procedure										
	Identification									
		Final-approach segment (FAS) guidance	Code list	The name describing the type of radio navigation aid providing the final approach lateral guidance e.g. ILS, VOR, RNAV, etc.	APCH					
		RWY	Text	The RWY designator of the landing and take-off direction, e.g. 27, 35L, 01R						
		Circling	Code list	Indication if a procedure is/is not a circling approach	APCH					
		Multiple code	Text	A single-letter suffix, starting with the letter 'z', following the radio navigation aid type, shall be used if two or more procedures to the same RWY cannot be distinguished by the radio navigation aid type only, e.g. VOR y RWY 20 or VOR z RWY 20.	APCH					

Subject	Property	Sub-property	Type	Description	Note	Accuracy	Integrity	Orig. Type	Pub. Res.	Chart Res.
		NS limiter	Text	Sensor-specific information in case of a use limitation	PBN only					
		Name	Text	Name of the instrument flight procedure						
	Plain- language designation									
		Basic indicator	Text	The basic indicator shall be the name or code names of the significant point where the standard departure route terminates.	SID, STAR					
		Validity indicator	Text	The validity indicator shall be a number from 1 to 9.	SID, STAR					
		Route indicator	Text	The route indicator shall be one letter of the alphabet. The letters 'I' and 'O' shall not be used.	SID, STAR					
		Visual indication	Text	Indication if the route has been established for aircraft operating in accordance with VFR	VFR only					
	Coded designation									

Subject	Property	Sub-property	Type	Description	Note	Accuracy	Integrity	Orig. Type	Pub. Res.	Chart Res.
		Significant Point	Text	The coded designator or code names of the significant point	SID, STAR					
		Validity indicator	Text	The validity indicator of the procedure	SID, STAR					
		Route indicator	Text	The route indicator of the procedure	SID, STAR					
	Procedure type		Code list	Indication of the type of procedure (departure, arrival, approach, other)						
	PBN or conventional		Code list	Indication if the procedure is PBN or conventional	IFR only					

Subject	Property	Sub-property	Type	Description	Note	Accuracy	Integrity	Orig. Type	Pub. Res.	Chart Res.
	Precision type		Text	The instrument procedure type; instrument approach procedures are classified as follows: (a) non-precision approach (NPA) procedure: an instrument approach procedure that utilises lateral but not vertical guidance. (b) approach procedure with vertical guidance (APV): an instrument procedure that utilises lateral and vertical guidance but does not meet the requirements established for precision-approach and -landing operations. (c) precision approach (PA) procedure: an instrument approach procedure using precision lateral and vertical guidance with minima as determined by the category of operation.	APCH					
	Aircraft category		Code list	Indication of which aircraft categories the procedure is intended for						
	Magnetic variation		Value	The magnetic variation considered for the procedure design						
	Obstacle clearance altitude/height (OCA/H)			OCA/H	APCH					
		Aircraft category	Code list	Aircraft category	APCH					

Subject	Property	Sub-property	Type	Description	Note	Accuracy	Integrity	Orig. Type	Pub. Res.	Chart Res.
		Approach type	Code list	Approach type (e.g. straight-in, Cat I, Cat II, LLZ, circling, etc.), or specific navigation aid (e.g. step-down fixes), or a specific navigation specification	APCH					
		Altitude	Altitude	The lowest altitude used in establishing compliance with appropriate obstacle clearance criteria	APCH		Essential			
		Height	Height	The lowest height above the elevation of the relevant RWY threshold or the aerodrome elevation, as applicable, used in establishing compliance with appropriate obstacle clearance criteria	APCH		Essential			
	Decision altitude/height (DA/H)			DA/H	APCH					
		Aircraft category	Code list	Aircraft category	APCH					
		Approach type	Code list	Approach type (e.g. straight-in, circling, etc.), or specific navigation aid (e.g. step-down fixes), or a specific navigation specification	APCH					

Subject	Property	Sub-property	Type	Description	Note	Accuracy	Integrity	Orig. Type	Pub. Res.	Chart Res.
		Altitude	Altitude	A specified altitude in a 3D instrument approach operation at which a missed approach shall be initiated if the required visual reference to continue the approach is not established	APCH					
		Height	Height	A specified height in a 3D instrument approach operation at which a missed approach shall be initiated if the required visual reference to continue the approach is not established	APCH					
	Minimum descent altitude/height (MDA/H)			MDA/H	APCH					
		Aircraft category	Code list	Aircraft category	APCH					
		Approach type	Code list	Approach type (e.g. straight-in, circling, etc.), or specific navigation aid (e.g. step-down fixes), or a specific navigation specification	APCH					
		Altitude	Altitude	A specified altitude in a 2D instrument approach operation or circling approach operation below which descent shall not be initiated without the required visual reference	APCH					
		Height	Height	A specified height in a 2D instrument approach operation or circling approach operation below which descent shall not be initiated without the required visual reference	APCH					

Subject	Property	Sub-property	Type	Description	Note	Accuracy	Integrity	Orig. Type	Pub. Res.	Chart Res.
	Minimum sector altitude (MSA)			The lowest altitude that may be used and will provide a minimum clearance of 300 m (1 000 ft) above all objects located in an area contained within a sector of a circle of 46 km (25 nm) radius centred on a radio aid to navigation	IFR only					
		Sector start angle	Angle	Start angle of a sector						
		Sector end angle	Angle	End angle of a sector						
		Based on fix	Text	Centre of the MSA						
		Altitude	Altitude	The minimum altitude for each sector						
		Restrictions	Text	MSA: the lowest altitude that may be used and will provide a minimum clearance of 300 m (1 000 ft) above all objects located in an area contained within a sector of a circle of 46 km (25 nm) radius centred on a radio aid to navigation.						
		Radius	Value	The radius of each sector						

Subject	Property	Sub-property	Type	Description	Note	Accuracy	Integrity	Orig. Type	Pub. Res.	Chart Res.
	Terminal arrival altitude (TAA)			The lowest altitude that will provide a minimum clearance of 300 m (1 000 ft) above all objects located in an arc of a circle defined by a 46 km (25 nm) radius centred on the initial-approach fix (IAF) or, where there is no IAF, on the intermediate-approach fix (IF), delimited by straight lines joining the extremity of the arc to the IF; the combined TAAs associated with an approach procedure shall account for an area of 360 degrees around the IF.	APCH or PBN only					
		Reference point	Text	TAA reference point (IAF or IF)						
		IAF	Text	TAA IAF reference point						
		IF	Text	TAA IF reference point						
		Distance to IAF	Distance	The distance of the TAA area boundary from the IAF						
		Altitude	Altitude	The terminal arrival altitude value						
		Sector start angle	Angle	Start angle of a sector (bearing to the TAA reference point)						

Subject	Property	Sub-property	Type	Description	Note	Accuracy	Integrity	Orig. Type	Pub. Res.	Chart Res.
		Sector end angle	Angle	End angle of a sector (bearing to the TAA reference point)						
		Step-down arc	Distance	Radius of the inner area at a lower altitude.						
	Navigation specification name		Text	<p>A set of aircraft and flight crew requirements needed to support PBN operations within a defined airspace; there are two kinds of navigation specifications:</p> <p>(a) RNP specifications: navigation specifications based on area navigation that includes the requirement for performance monitoring and alerting, designated by the prefix RNP, e.g. RNP 4, RNP APCH.</p> <p>(b) RNAV specifications: navigation specifications based on area navigation that does not include the requirement for performance monitoring and alerting, designated by the prefix RNAV, e.g. RNAV 5, RNAV 1.</p>	PBN only					

Subject	Property	Sub-property	Type	Description	Note	Accuracy	Integrity	Orig. Type	Pub. Res.	Chart Res.
	Operating minima		Text	Aerodrome operating minima: the usability limits of an aerodrome for: (a) take-off, expressed in terms of RVR and/or visibility and, if necessary, cloud conditions; (b) landing in precision approach and landing operations, expressed in terms of visibility and/or RVR and DA/H, as appropriate to the category of the operation; (c) landing in approach and landing operations with vertical guidance, expressed in terms of visibility and/or RVR and DA/H; and (d) landing in non-precision approach and landing operations, expressed in terms of visibility and/or RVR, minimum descent altitude/height (MDA/H) and, if necessary, cloud conditions	APCH, DEP					
	Temperature									
		Minimum temperature	Value	Minimum temperature reference	APCH or PBN only					

Subject	Property	Sub-property	Type	Description	Note	Accuracy	Integrity	Orig. Type	Pub. Res.	Chart Res.
		Maximum temperature	Value	Maximum temperature reference	APCH or PBN only					
	Remote altimeter source		Text	Cautionary note indicating the altimetry source	APCH					
	Proc Ref datum		Text	Aerodrome or landing threshold	APCH					
	PBN requirements			Specific requirements related to a PBN procedure	PBN					
			Code list	Identification of the navigation specification (RNAV 5, RNP 0.3, etc.)						
		Navigation specification	Text	Any navigation sensor limitations (global navigation satellite system (GNSS) required)						
		Functional requirements	Text	Any required functionalities described as options in the navigation specification, that is, not included in the core navigation specification (radio frequency (RF) required)						

Subject	Property	Sub-property	Type	Description	Note	Accuracy	Integrity	Orig. Type	Pub. Res.	Chart Res.
Procedure segment					SID, STAR, APCH					
	Start		Text	Identification of the start point of the segment						
	End		Text	Identification of the end point, or a description of the end, of the segment						
	End fix functionality		Code list	Indication if the end fix is a fly-by point (a waypoint that requires a turn to allow tangential interception of the next segment of a route or procedure) or flyover point (a waypoint at which a turn is initiated in order to join the next segment of a route or procedure)	PBN					
	End fix role		Code list	Indication of the role of the end fix missed-approach point (MAPt), IF, IAF, final-approach fix (FAF), missed approach holding fix (MAHF), etc.						
	Procedure altitude/height		Altitude/height	A specified altitude/height flown operationally above the minimum altitude/height and established to accommodate a stabilised descent at a prescribed- descent gradient/angle in	Certain segments of SID, STAR, APCH only		Essential			

Subject	Property	Sub-property	Type	Description	Note	Accuracy	Integrity	Orig. Type	Pub. Res.	Chart Res.
				the intermediate/final approach segment						
	Minimum obstruction clearance altitude (MOCA)		Altitude	The minimum altitude of a defined segment, which provides the required obstacle clearance	SID, STAR, APCH					
	Distance		Distance	Geodesic distance to the nearest tenth of a kilometre or of a nautical mile between each successive designated significant point		1/100 km	Essential	Calculated	1/100 km or 1/100 nm	1 km or 1 nm
	True bearing		Bearing	True track to the nearest tenth of a degree between each successive significant point	SID, STAR, APCH	1/10 degree	Routine	Calculated	1/10 degree	
	Magnetic bearing		Bearing	Magnetic track to the nearest tenth of a degree between each successive significant point	SID, STAR, APCH	1/10 degree	Routine	Calculated	1 degree	1 degree
	Gradient		Value		APCH, DEP					

Subject	Property	Sub-property	Type	Description	Note	Accuracy	Integrity	Orig. Type	Pub. Res.	Chart Res.
	Speed		Value	Speed limit at a significant point, expressed in units of 10 kt, as applicable						
	Controlling obstacle				APCH, DEP					
		Type	Text	Indication if the obstacle is lit/unlit, type of obstacle (church/wind turbine, etc.)						
		Position	Point	Coordinates of the controlling obstacle		See Section 6 'Obstacle data'.				
		Elevation:	Elevation	Elevation of the top of the controlling obstacle		See Section 6 'Obstacle data'				
Final-approach segment				That segment of an instrument approach procedure in which alignment and descent for landing are accomplished	SBAS APCH, GBAS APCH					
	Operation type		Text	A number indicating the type of the final approach segment (e.g. '0' is						

Subject	Property	Sub-property	Type	Description	Note	Accuracy	Integrity	Orig. Type	Pub. Res.	Chart Res.
				coded for a straight-in approach procedure including offset procedures.)						
	Approach performance designator		Text	A number identifying the type of an approach ('0' is used to identify a localizer performance with vertical guidance (LPV) approach procedure and a '1' indicates a Category I approach procedure)						
	SBAS provider		Text	Identifier of a service provider of a particular satellite-based approach system	SBAS only					
	Reference path data selector (RPDS)		Text	A numerical identifier, unique on a frequency in the broadcast region and used to select the FAS data block	GBAS only					
	Reference path identifier (RPI)		Text	A four-character identifier used to confirm the selection of the correct approach procedure						

Subject	Property	Sub-property	Type	Description	Note	Accuracy	Integrity	Orig. Type	Pub. Res.	Chart Res.
	Landing threshold point (LTP) or fictitious threshold point (FTP)			LTP/FTP						
		Position	Point	Latitude and longitude of the LTP/FTP		0.3 m (1 ft)	Critical		0.0005" (0.01')	
		Ellipsoidal height	Elevation	The height of the LTP/FTP above the WGS-84 ellipsoid		0.25 m	Critical		0.1 m	
		Orthometric height	Elevation	The height of the LTP/FTP as related to the geoid and presented as an MSL elevation						
	Flight path alignment point (FPAP)			FPAP						
		Position	Point	Latitude and longitude of the FPAP		0.3 m (1 ft)	Critical		0.0005" (0.01')	
		Orthometric height	Elevation	The height of the FPAP as related to the geoid and presented as an MSL elevation						

Subject	Property	Sub-property	Type	Description	Note	Accuracy	Integrity	Orig. Type	Pub. Res.	Chart Res.
	Approach threshold crossing height (TCH)		Height	The designated crossing height of the flight path angle above the LTP (or FTP)		0.5 m	Critical	Calculated	0.05 m	
	Glide path angle (GPA)		Value	The angle of the approach path (glide path) with respect to the horizontal plane, defined in accordance with WGS-84 at the LTP/FTP		0.01°m	N/a		0.01°m	
	Course width at threshold		Value	The semi-width of the lateral course width at the LTP/FTP, defining the lateral offset at which the receiver achieves full- scale deflection.		N/a	Critical		0.25 m	
	Delta length offset		Distance	The distance from the stop end of the RWY to the FPAP; it defines the location where lateral sensitivity changes to missed-approach sensitivity.		N/a	N/a		8 m	
	Horizontal alert limit (HAL)		Value	HAL	SBAS only					
	Vertical alert limit (VAL)		Value	VAL	SBAS only					

Subject	Property	Sub-property	Type	Description	Note	Accuracy	Integrity	Orig. Type	Pub. Res.	Chart Res.
	FAS data block		Text	A binary string describing the FAS data block generated with an appropriate software tool; the FAS data block is a set of parameters to identify a single precision approach or an APV and define its associated approach.						
	CRC remainder		Text	An 8-character hexadecimal representation of the calculated remainder bits, used to determine the integrity of the FAS data block during transmission and storage.						

Subject	Property	Sub-property	Type	Description	Note	Accuracy	Integrity	Orig. Type	Pub. Res.	Chart Res.
Procedure fix										
	Identification		Text	Names, coded designators or code names given to the significant point						
	ATC reporting requirements		Text	Indication of the ATS/MET reporting requirement as 'compulsory', 'on request' or 'NIL'						
	VFR reporting point		Text	Bridge or church name	VFR					
	Position		Point	Geographical location of the fix		See Note 1				
	Type		Text	Indication of the type of the fix, such as navaid, Int, waypoint						
	Formations									
		Navaid	Text	The station identification of the VOR/DME reference						
		Bearing	Bearing	The bearing to the VOR/DME reference if the waypoint is not collocated with it		See Note 2				

Subject	Property	Sub-property	Type	Description	Note	Accuracy	Integrity	Orig. Type	Pub. Res.	Chart Res.
		Distance	Distance	The distance from the VOR/DME reference if the waypoint is not collocated with it		1/100 km	Essential	Calculated	1/100 km or 1/100 nm	2/10 km (1/10 nm)
					Note 1	100 m	Essential	Surveyed/calculated	1 sec	1 sec
						3 m	Essential	Surveyed/calculated	1/10 sec	1 sec
					Note 2	1/10 degree	Routine	Calculated	1/10 degree	1/10 degree
						1/10 degree	Essential	Calculated	1/10 degree	1/10 degree
Procedure holding				A predetermined manoeuvre that keeps the aircraft within the specified airspace while awaiting further clearance						
	Identification		Text	Identification of the holding procedure						
	Fix		Point	Geographical location that serves as a reference for a holding procedure		Same as the procedure fix				

Subject	Property	Sub-property	Type	Description	Note	Accuracy	Integrity	Orig. Type	Pub. Res.	Chart Res.
	Inbound course		Course	Inbound true course					1/10 degree	
	Outbound course		Course	Outbound true course					1/10 degree	
	Leg distance		Distance	Outbound distance of the leg					1/10 km or 1/10 nm	
	Leg time		Value	Outbound time of the leg						
	Limiting radial		Angle	Limiting radial from the VOR/DME on which the holding is based						
	Turn direction		Value	Direction of the procedure turn						
	Minimum altitude		Altitude	Minimum holding level to the nearest higher (50 m or 100 ft)/flight level		50 m	Routine	Calculated	50 m or 100 ft/flight level	
	Maximum altitude		Altitude	Maximum holding level to the nearest higher (50 m or 100 ft)/flight level					50 m or 100 ft/flight level	
	Speed		Value	Maximum indicated air speed					10 kt	
	Magnetic variation									

Subject	Property	Sub-property	Type	Description	Note	Accuracy	Integrity	Orig. Type	Pub. Res.	Chart Res.
		Angle	Angle	The magnetic variation of the radio navigation aid of the procedure						
		Date	Date	The date on which the magnetic variation had the corresponding value						
	Navigation specifications name		Text	Name of the navigation specification – set of aircraft and aircrew requirements needed to support a navigation application within a defined airspace concept	RNAV/RN P					
Helicopter procedure specifics										
	Helicopter procedure title (RNAV 263)		Text	Identification of the helicopter procedure						
	Heliport crossing height (HCH)		Height	Heliport crossing height			Essential		1 m or 1 ft	1 m or 1 ft
	Initial departure fix (IDF)		Point	Initial departure fix	DEP					
	Missed-approach point (MAPt)		Point	MAPt	APCH					

Subject	Property	Sub-property	Type	Description	Note	Accuracy	Integrity	Orig. Type	Pub. Res.	Chart Res.
	Direct visual segment			For PinS APP: the portion of flight that connects directly the PinS to the landing location; for PinS DEP: the portion of flight that connects directly the landing location to the IDF						
		Track	Line							
		Distance	Distance							
		Bearing	Angle							
		Crossing height	Height							
	Manoeuvring visual segment (VS)			PinS VS protected for the following manoeuvres: for PinS APCH: visual manoeuvre from the MAPt around the heliport or landing location to land from a direction other than directly from the MAPt; and for PinS DEP: take-off in a direction other than directly to the IDF, followed by a visual manoeuvre to join the instrument segment at the IDF	APCHDEP					
		Centre line	Angle	Centre line of the take-off climb surface	DEP					

Subject	Property	Sub-property	Type	Description	Note	Accuracy	Integrity	Orig. Type	Pub. Res.	Chart Res.
		Manoeuvring area	Polygon	Area where the pilot is expected to manoeuvre visually	APCH DEP					
		No manoeuvring area	Polygon	Area where manoeuvring is prohibited	APCH DEP					
		Ingress tracks	Line	PinS VS protected for the following manoeuvres: for PinS APCH: visual manoeuvre from the MAPt around the heliport or landing location to land from a direction other than directly from the MAPt; and for PinS DEP: take-off in a direction other than directly to the IDF, followed by a visual manoeuvre to join the instrument segment at the IDF	APCH DEP					
	HAS			Height above the surface diagram	APCH					
		Radius	Distance							
		Height above surface	Height							
	'Proceed visually' text		Text	Text indicating that the procedure has a 'Proceed visually' instruction						
	'Proceed VFR' text		Text	Text indicating that the procedure has a 'Proceed VFR' instruction						

Subject	Property	Sub-property	Type	Description	Note	Accuracy	Integrity	Orig. Type	Pub. Res.	Chart Res.
	Visual segment descent angle (VSDA)		Value	VSDA						
	Ingress tracks									
		Length	Distance							
		Width	Distance							
		Bearing	Angle							
AITF				Notes on charts (aeronautical information in textual format)						
	Non-aligned between instrument and visual slope indications		Text							
	Missed-approach description		Text	Missed-approach description of the procedure						
	SID/STAR route description		Text	Textual description of the SID or STAR procedure						
	Missed-approach climb gradient		Value	The value of the missed-approach climb gradient of the approach procedure						
	CAT H note		Text							

Subject	Property	Sub-property	Type	Description	Note	Accuracy	Integrity	Orig. Type	Pub. Res.	Chart Res.
	CAT D large		Text							
	Authorisation required (AR)		Text	Indication that RNP AR						
	Units of measurement		Text							
	GNSS in lieu of									
	Communication failure		Text	Communication failure description						
	Surveillance/radar required									
	SID close-in obstacle note		Text	Indication wherever close-in obstacles exist which were not considered in the determination of the published-procedure design gradient						
	Offset alignment									
	PDG greater than 3 %									

5. Radio navigation aids/systems data

Subject	Property	Sub-property	Type	Description	Note	Accuracy	Integrity	Orig. Type	Pub. Res.	Chart Res.
Radio navigation aid										
	Type		Text	Type of the radio navigation aid						
	Identification		Text	The code assigned to uniquely identify the navaid						
	Name		Text	The textual name assigned to the navaid						
	ILS facility classification		Code list	A classification based on the functional and performance capabilities of an ILS	ILS					
	GBAS facility classification		Code list	A classification based on the functional and	GBAS					

Subject	Property	Sub-property	Type	Description	Note	Accuracy	Integrity	Orig. Type	Pub. Res.	Chart Res.
				performance capabilities of the GBAS ground subsystem						
	GBAS approach facility designation		Code list	A classification based on the GBAS service volume and performance requirements for each supported approach	GBAS					
	Area of operation		Text	Indication whether navigation aid serves en-route (E), aerodrome (A) or dual (AE) purposes						
	Aerodrome/heliport served		Text	The ICAO location indicator or name of the aerodromes /heliports served						

Subject	Property	Sub-property	Type	Description	Note	Accuracy	Integrity	Orig. Type	Pub. Res.	Chart Res.
	RWY served		Text	Designator of the RWY served						
	Operating entity		Text	Name of the operating entity of the facility						
	Type of supported operations		Code list	Indication of the type of supported operation for ILS/MLS, basic GNSS, satellite-based augmentation system (SBAS), and ground-based augmentation system (GBAS)						
	Collocation		Text	Information that a navaid is collocated with another navaid						
	Hours of operation		Schedule	The hours of operation of the radio navigation aid						

Subject	Property	Sub-property	Type	Description	Note	Accuracy	Integrity	Orig. Type	Pub. Res.	Chart Res.
	Magnetic variation			The angular difference between the true north and the magnetic north						
		Angle	Angle	The magnetic variation at the radio navigation aid	ILS/NDB	See Note 1 below				
		Date	Date	The date on which the magnetic variation had the corresponding value						
	Station declination		Angle	An alignment variation of the navaid between the zero-degree radial and the true north, determined at the time the station is calibrated	VOR/ILS/MLS					

Subject	Property	Sub-property	Type	Description	Note	Accuracy	Integrity	Orig. Type	Pub. Res.	Chart Res.
	Zero bearing direction		Text	Direction of the 'zero bearing' provided by the station, e.g. magnetic north, true north, etc.	VOR					
	Frequency		Value	Frequency or tuning frequency of the radio navigation aid						
	Channel		Text	The channel number of the radio navigation aid	DME or GBAS					
	Position		Point	Geographical location of the radio navigation aid		See Note 2 below				
	Elevation		Elevation	The elevation of the transmitting antenna of the DME or the elevation of	DME or GBAS	See Note 3 below				

Subject	Property	Sub-property	Type	Description	Note	Accuracy	Integrity	Orig. Type	Pub. Res.	Chart Res.
				the GBAS reference point						
	Ellipsoidal height		Height	The ellipsoidal height of the GBAS reference point	GBAS					
	Localiser alignment									
		Bearing	Bearing	The localiser course	ILS localiser	1/100 degree	Essential	Surveyed	1/100 degree (if true)	1 degree
		Type	Text	The type of localiser alignment, true or magnetic	ILS localiser					
	Zero azimuthal alignment		Bearing	MLS zero azimuthal alignment	MLS	1/100 degree	Essential	Surveyed	1/100 degree (if true)	1 degree
	Angle		Angle	The angle of the glide path of an ILS or the normal glide path angle of an MLS installation	ILS GP/MLS					
	RDH		Value	The value of the ILS reference datum	ILS GP	0.5 m	Critical	Calculated		

Subject	Property	Sub-property	Type	Description	Note	Accuracy	Integrity	Orig. Type	Pub. Res.	Chart Res.
				height (ILS RDH)						
	Localiser antenna to RWY end distance		Distance	ILS localiser — RWY/FATO end distance	ILS localiser	3 m	Routine	Calculated	1 m or 1 ft	As plotted
	ILS glideslope antenna to TRSH distance		Distance	ILS glideslope antenna — threshold distance along the centre line	ILS GP	3 m	Routine	Calculated	1 m or 1 ft	As plotted
	ILS marker to TRSH distance		Distance	ILS marker — threshold distance	ILS	3 m	Essential	Calculated	1 m or 1 ft	2/10 km (1/10 nm)
	ILS DME antenna to TRSH distance		Distance	ILS DME antenna — threshold distance along the centre line	ILS	3 m	Essential	Calculated	1 m or 1 ft	As plotted
	MLS azimuthal antenna to RWY end distance		Distance	MLS azimuthal antenna — RWY/FATO end distance	MLS	3 m	Routine	Calculated	1 m or 1 ft	As plotted
	MLS elevation antenna to TRSH distance		Distance	MLS elevation antenna — threshold distance	MLS	3 m	Routine	Calculated	1 m or 1 ft	As plotted

Subject	Property	Sub-property	Type	Description	Note	Accuracy	Integrity	Orig. Type	Pub. Res.	Chart Res.
				along the centre line						
	MLS DME antenna to TRHS distance		Distance	MLS DME/P antenna — threshold distance along the centre line	MLS	3 m	Essential	Calculated	1 m or 1 ft	As plotted
	Signal polarisation		Code list	GBAS signal polarisation (GBAS/H or GBAS/E)	GBAS					
	Designated operational coverage (DOC)		Text	DOC or standard service volume (SSV) as range or service volume radius from the navaid/GBAS reference point, height and sectors, if required						
			Note 1		ILS Localiser	1 degree	Essential	Surveyed	1 degree	
					NDB	1 degree	Routine	Surveyed	1 degree	
								Surveyed		

Subject	Property	Sub-property	Type	Description	Note	Accuracy	Integrity	Orig. Type	Pub. Res.	Chart Res.
			Note 2		Aerodrome navaid	3 m	Essential	Surveyed	1/10 sec	As plotted
					GBAS reference point	1 m		Surveyed		
					En-route	100 m	Essential	Surveyed	1 sec	
								Surveyed		
			Note 3		DME	30 m (100 ft)	Essential	Surveyed	30 m (100 ft)	30 m (100 ft)
					DME/P	3 m	Essential	Surveyed	3 m (10 ft)	
					GBAS reference point	0.25 m	Essential		1 m or 1 ft	
GNSS				A worldwide position and time determinati on system that includes one or more satellite constellation s, aircraft receivers and system integrity monitoring, augmented as necessary to support the required						

Subject	Property	Sub-property	Type	Description	Note	Accuracy	Integrity	Orig. Type	Pub. Res.	Chart Res.
				navigation performance for the intended operation						
	Name		Text	The name of the GNSS element (GPS, GBAS, GLONASS, EGNOS, MSAS, WAAS, etc.)						
	Frequency		Value	Frequency of the GNSS	As appropriate					
	Service area		Polygon	Geographical location of the GNSS service area						
	Coverage area		Polygon	Geographical location of the GNSS coverage area						
	Operating authority		Text	Name of the operating authority of the facility						
Subject	Property	Sub-property	Type	Description	Note	Accuracy	Integrity	Orig. Type	Pub. Res.	Chart Res.
Aeronautical ground lights				Ground lights and other light						

Subject	Property	Sub-property	Type	Description	Note	Accuracy	Integrity	Orig. Type	Pub. Res.	Chart Res.
				beacons designating geographical positions that are selected by the Member State as being significant						
	Type		Text	Type of beacon						
	Designator		Text	The code assigned to uniquely identify the beacon						
	Name		Text	The name of the city or town or other identification of the beacon						
	Intensity		Value	Intensity of the light of the beacon					1000 cd	
	Characteristics		Text	Information about the characteristics of the beacon						

Subject	Property	Sub-property	Type	Description	Note	Accuracy	Integrity	Orig. Type	Pub. Res.	Chart Res.
	Hours of operations		Schedule	The hours of operation of the beacon						
	Position		Point	Geographical location of the beacon						
Marine lights										
	Position		Point	Geographical location of the beacon						
	Visibility range		Distance	The visibility range of the beacon						
	Characteristics		Text	Information about the characteristics of the beacon						
Special navigation system				Stations associated with special navigation systems (DECCA, LORAN, etc.)						
	Type		Text	Type of service available (master signal, slave signal, colour)						

Subject	Property	Sub-property	Type	Description	Note	Accuracy	Integrity	Orig. Type	Pub. Res.	Chart Res.
	Designator		Text	The code assigned to uniquely identify the special navigation system						
	Name		Text	The textual name assigned to the special navigation system						
	Frequency		Value	Frequency (channel number, basic pulse rate, recurrence rate, as applicable) of the special navigation system						
	Hours of operations		Schedule	The hours of operation of the special navigation system						
	Position		Point	Geographical location of the special		100 m	Essential	Surveyed/ calculated		

Subject	Property	Sub-property	Type	Description	Note	Accuracy	Integrity	Orig. Type	Pub. Res.	Chart Res.
				navigation system						
	Operating entity		Text	Name of the operating entity of the facility						
	Facility coverage		Text	Description of the special navigation system facility coverage						

6. Obstacle data

Subject	Property	Sub-property	Type	Description	Note	Accuracy	Integrity	Orig. Type	Pub. Res.	Chart Res.
Obstacle				All fixed (whether temporary or permanent) and mobile obstacles or parts thereof						
	Obstacle identifier		Text	Unique identifier of the obstacle						
	Operator/owner		Text	Name and contact information of the obstacle operator or owner						
	Geometry type		Code list	An indication whether the obstacle is a point, line or polygon						
	Horizontal position		Point or line or polygon	Horizontal position of the obstacle		See Note 1 below				
	Horizontal extent		Distance	Horizontal extent of the obstacle						
	Elevation		Elevation	Elevation of the highest point of the obstacle		See Note 2 below				
	Height		Height	Height of the obstacle above ground						
	Type		Text	Type of obstacle						

Subject	Property	Sub-property	Type	Description	Note	Accuracy	Integrity	Orig. Type	Pub. Res.	Chart Res.
	Date and time stamp		Date	Date and time the obstacle was created						
	Operations		Text	Feature operations of the mobile obstacles						
	Effectivity		Text	Effectivity of temporary types of obstacles						
	Lighting									
		Type	Text	Type of lighting						
		Colour	Text	Colour of the obstacle lighting						
	Marking		Text	Type of obstacle marking						
	Material		Text	Predominant surface material of the obstacle						
			Note 1	Obstacles in Area 1		50 m	Routine	Surveyed	1 sec	As plotted
				Obstacles in Area 2 (including 2a, 2b, 2c, 2d, take-off flight path area, and obstacle limitation surfaces)		5 m	Essential	Surveyed	1/10 sec	1/10 sec
				Obstacles in Area 3		0.5 m	Essential	Surveyed	1/10 sec	1/10 sec
				Obstacles in Area 4		2.5 m	Essential	Surveyed		

Subject	Property	Sub-property	Type	Description	Note	Accuracy	Integrity	Orig. Type	Pub. Res.	Chart Res.
			Note 2	Obstacles in Area 1		30 m	Routine	Surveyed	1 m or 1 ft	3 m (10 ft)
				Obstacles in Area 2 (including 2a, 2b, 2c, 2d, take-off flight path area, and obstacle limitation surfaces)		3 m	Essential	Surveyed	1 m or 1 ft	1 m or 1 ft
				Obstacles in Area 3		0.5 m	Essential	Surveyed	0.1 m or 0.1 ft or 0.01 m	1 m or 1 ft
				Obstacles in Area 4		1 m	Essential	Surveyed	0.1 m	

7. Geographic data

Subject	Property	Sub-property	Type	Description	Note	Accuracy	Integrity	Orig. Type	Pub. Res.	Chart Res.
Buildings				Buildings (of operational significance) and other salient/prominent (aerodrome) features						
	Name		Text	Name of the building						
	Geometry		Polygon	Geographical location of the building						
Built-up areas				Areas covered by cities, towns and villages						
	Name		Text	Name of the built-up area						
	Geometry		Point/polygon	Geographical location of the built-up area						
Railroads				All railroads having landmark value						
	Name		Text	Name of the railroad						
	Geometry		Line	Geographical location of the railroads						
Highways and roads				All highways and roads having landmark value						
	Name		Text	Name of highways and roads						

Subject	Property	Sub-property	Type	Description	Note	Accuracy	Integrity	Orig. Type	Pub. Res.	Chart Res.
	Geometry		Line	Geographical location of highways and roads						
Landmarks				Natural and cultural landmarks, such as bridges, prominent transmission lines, permanent cable car installations, wind turbines, mine structures, forts, ruins, levees, pipelines, rocks, bluffs, cliffs, sand dunes, isolated lighthouses and light ships, when considered to be of importance for visual air navigation						
	Characteristics		Text	Description of the landmark						
	Geometry		Line	Geographical location of the railroads						
Political boundaries				International political boundaries						
	Geometry		Line	Geographical location of the international political boundaries						
Hydrography				All water features comprising shorelines, lakes, rivers and streams (including those non-perennial in nature), salt lakes, glaciers and ice caps						
	Name		Text	Name of the water feature						

Subject	Property	Sub-property	Type	Description	Note	Accuracy	Integrity	Orig. Type	Pub. Res.	Chart Res.
	Geometry		Line/polygon	Geographical location of the water feature						
Wooded areas				Wooded areas						
	Geometry		Polygon	Geographical location of the wooded area						

Subject	Property	Sub-property	Type	Description	Note	Accuracy	Integrity	Orig. Type	Pub. Res.	Chart Res.
Service roads				Part of the aerodrome surface used by service vehicles						
	Geometry		Polygon	Geographical location of the service roads						
	Feature base		Text	Identification of the feature type affected						
	Identifier base		Text	Name of the underlying TWY, parking stand area or apron						
Construction area				Part of the aerodrome area under construction						
	Geometry		Polygon	Geographical location of the construction area						
Area unsuitable for aircraft movement				Areas unsuitable for aircraft movement						
	Geometry		Polygon	Depicted movement area permanently unsuitable for aircraft and clearly identified as such						
Survey control point				A monumented survey control point						
	Identifier number		Text	Special unique identifier permanently assigned to a feature instance by the data provider						

Subject	Property	Sub-property	Type	Description	Note	Accuracy	Integrity	Orig. Type	Pub. Res.	Chart Res.
	Location		Point	Geographical location of the survey control point						
	Elevation		Elevation	Elevation of the survey control point						
Aerodrome surface routing network (ASRN) node				A vertex in a graph defining the ASRN						
	Identifier network		Text	Logical name comprised of a delimited list of names for one or more features associated with the ASRN feature						
	Identifier threshold		Text	Name of the feature instance						
	Identifier number		Text	Special unique identifier permanently assigned to a feature instance by a data provider						
	Term ref		Text	Terminal building associated with the feature instance						
	Node type		Text	Type of node						
	Cat stop		Text	Low-visibility operation category of the holding position						
	Position		Point	Geographical location of the ASRN node						

Subject	Property	Sub-property	Type	Description	Note	Accuracy	Integrity	Orig. Type	Pub. Res.	Chart Res.
ASRN edge				A connection between the nodes in a graph, which defines the ASRN						
	Identifier network		Text	Logical name comprised of a delimited list of names for one or more features associated with the ASRN feature						
	Direction		Text	One-way or two-way directionality of the corresponding feature instance						
	Node1 ref		Text	The identifier number of the ASRN node corresponding to the start point of the edge geometry						
	Node2 ref		Text	The identifier number of the ASRN node corresponding to the end point of the edge geometry						
	Edge type		Text	Type of edge						
	Edge derv		Text	Derivation method of the edge geometry						
	Geometry		Line	Geographical location of the ASRN edge						

Data types referred to in column 4 ‘Type’

Type	Description	Data items
Point	A pair of coordinates (latitude and longitude) referenced to the mathematical ellipsoid, which define the position of the point on the surface of the Earth	Latitude Longitude Horizontal reference system Units of measurement Horizontal accuracy achieved
Line	Sequence of points defining a linear object	Sequence of points
Polygon	Sequence of points forming the boundary of the polygon; the first and last point are identical	Closed sequence of points
Height	The vertical distance of a level, point or an object, considered as a point, measured from a specific datum	Numerical value Vertical reference system Units of measurement Vertical accuracy achieved
Altitude	The vertical distance of a level, point or an object, considered as a point, measured from the MSL	Numerical value Vertical reference system Units of measurement Vertical accuracy achieved
Elevation	The vertical distance of a point or a level on, or affixed to, the surface of the Earth, measured from the MSL	Numerical value Vertical reference system Units of measurement Vertical accuracy achieved
Distance	A linear value	Numerical value Units of measurement Accuracy achieved
Angle/bearing	An angular value	Numerical value Units of measurement Accuracy achieved
Value	Any measured, declared or derived value not listed above	Numerical value Units of measurement Accuracy achieved
Date	A calendar date referencing a particular day or month	Text
Schedule	A repetitive time period, composed of one or more intervals or special dates (e.g. holidays) occurring cyclically	Text
Code list	A set of predefined text strings or values	Text
Text	Free text	String of characters without constraints'

ANNEX IV — PART-ATS

SPECIFIC REQUIREMENTS FOR PROVIDERS OF AIR TRAFFIC SERVICES

SUBPART A — ADDITIONAL ORGANISATION REQUIREMENTS FOR PROVIDERS OF AIR TRAFFIC SERVICES (ATS.OR)

SECTION 1 — GENERAL REQUIREMENTS

GM1 Annex IV (Part-ATS)

ED Decision 2020/008/R

GENERAL

In the context of the AMC and GM to Part-ATS, the terms listed below have the following meaning:

- 'accepting air traffic controller (ATCO)' refers to the air traffic controller next to take control of an aircraft;
- 'accepting control unit' refers to the air traffic control unit next to take control of an aircraft;
- 'advisory airspace' refers to an airspace of defined dimensions, or designated route, within which air traffic advisory service is available;
- 'advisory route' refers to a designated route along which air traffic advisory service is available;
- 'airborne collision avoidance system (ACAS)' refers to an aircraft system based on secondary surveillance radar (SSR) transponder signals which operates independently of ground-based equipment to provide advice to the pilot on potential conflicting aircraft that are equipped with SSR transponders;
- 'aircraft address' refers to a unique combination of 24 bits available for assignment to an aircraft for the purpose of air-ground communications, navigation and surveillance;
- 'air-taxiing' refers to the movement of a helicopter/vertical take-off and landing (VTOL) aircraft above the surface of an aerodrome, normally in ground effect and at a ground speed normally less than 37 km/h (20 kt). The actual height may vary, and some helicopters may require air-taxiing above 8 m (25 ft) above ground level (AGL) to reduce ground effect turbulence or provide clearance for cargo slingloads;
- 'air traffic' refers to all aircraft in flight or operating on the manoeuvring area of an aerodrome;
- 'approach sequence' refers to the order in which two or more aircraft are cleared to approach to land at the aerodrome;
- 'base turn' refers to a turn executed by the aircraft during the initial approach between the end of the outbound track and the beginning of the intermediate or final approach track. The tracks are not reciprocal. Base turns may be designated as being made either in level flight or while descending, according to the circumstances of each individual procedure;

-
- ‘change-over point’ refers to the point at which an aircraft navigating on an ATS route segment defined by reference to very high-frequency omnidirectional radio ranges is expected to transfer its primary navigational reference from the facility behind the aircraft to the next facility ahead of the aircraft. Change-over points are established to provide the optimum balance in respect of signal strength and quality between facilities at all levels to be used and to ensure a common source of azimuth guidance for all aircraft operating along the same portion of a route segment;
 - ‘common point’ refers to a point on the surface of the earth common to the tracks of two aircraft, used as a basis for the application of separation (e.g. significant point, waypoint, navigation aid, fix);
 - ‘controller-pilot’ refers to in different contexts the interaction between air traffic controllers and pilots;
 - ‘cruise climb’ refers to an aeroplane cruising technique resulting in a net increase in altitude as the aeroplane mass decreases;
 - ‘decision altitude (DA) or decision height (DH)’ refers to a specified altitude or height in a 3D instrument approach operation at which a missed approach must be initiated if the required visual reference to continue the approach has not been established. DA is referenced to mean sea level, and DH is referenced to the threshold elevation. The required visual reference is that section of the visual aids or of the approach area which should have been in view for sufficient time for the pilot to have made an assessment of the aircraft position and rate of change of position, in relation to the desired flight path. In Category III operations with a DH, the required visual reference is that specified for the particular procedure and operation;
 - ‘discrete code’ refers to a four-digit SSR code with the last two digits not being ‘00’;
 - ‘emergency phase’ refers to a generic term meaning, as the case may be, uncertainty phase, alert phase or distress phase;
 - ‘estimated elapsed time’ refers to the estimated time required to proceed from one significant point to another;
 - ‘expected approach time’ refers to the time at which air traffic control (ATC) expects that an arriving aircraft, following a delay, will leave the holding fix to complete its approach for a landing. The actual time of leaving the holding fix will depend upon the approach clearance;
 - ‘filed flight plan’ refers to the flight plan as filed with an air traffic services unit by the pilot or a designated representative, without any subsequent changes. When the word ‘message’ is used as a suffix to this term, it denotes the content and format of the filed flight plan data as transmitted;
 - ‘flight path monitoring’ refers to the use of ATS surveillance systems for the purpose of providing aircraft with information and advice relative to significant deviations from nominal flight path, including deviations from the terms of their ATC clearances;
 - ‘ground effect’ refers to a condition of improved performance (lift) due to the interference of the surface with the airflow pattern of the rotor system when a helicopter or other VTOL aircraft is operating near the ground. Rotor efficiency is increased by ground effect to a height of about one rotor diameter for most helicopters;

-
- ‘initial approach segment’ refers to that segment of an instrument approach procedure between the initial approach fix and the intermediate approach fix or, where applicable, the final approach fix or point;
 - ‘landing area’ refers to that part of a movement area intended for the landing or take-off of aircraft;
 - ‘minimum fuel’ is a term to be used to describe a situation in which an aircraft’s fuel supply has reached a state where the flight is committed to land at a specific aerodrome and no additional delay can be accepted;
 - ‘multilateration (MLAT) system’ refers to a group of equipment configured to provide position derived from the SSR transponder signals (replies or squitters) primarily using time difference of arrival (TDOA) techniques. Additional information, including identification, can be extracted from the received signals);
 - ‘normal operating zone (NOZ)’ refers to airspace of defined dimensions extending to either side of a published instrument approach procedure final approach course or track. Only that half of the NOZ adjacent to a no transgression zone (NTZ) is taken into account in independent parallel approaches;
 - ‘no transgression zone (NTZ)’ refers to, in the context of independent parallel approaches, a corridor of airspace of defined dimensions located centrally between the two extended runway centre lines, where a penetration by an aircraft requires an air traffic controller intervention to manoeuvre any threatened aircraft on the adjacent approach;
 - ‘obstacle clearance altitude (OCA)’ refers to the lowest altitude above the elevation of the relevant runway threshold or the aerodrome elevation as applicable, used in establishing compliance with appropriate obstacle clearance criteria. The OCA is referenced to mean sea level;
 - ‘obstacle clearance height (OCH)’ refers to the lowest height above the elevation of the relevant runway threshold or the aerodrome elevation as applicable, used in establishing compliance with appropriate obstacle clearance criteria. OCH is referenced to the threshold elevation or in the case of non-precision approach procedures to the aerodrome elevation or the threshold elevation if that is more than 2 m (7 ft) below the aerodrome elevation. An OCH for a circling approach procedure is referenced to the aerodrome elevation;
 - ‘onward clearance time’ refers to the time at which an aircraft can expect to leave the fix at which it is being held;
 - ‘procedural ATC service’ refers to a term that is used to indicate that information derived from an ATS surveillance system is not required for the provision of air traffic control service;
 - ‘procedural separation’ refers to the separation used when providing the procedural air traffic control service;
 - ‘procedure turn’ refers to a manoeuvre in which a turn is made away from a designated track followed by a turn in the opposite direction to permit the aircraft to intercept and proceed along the reciprocal of the designated track. Procedure turns are designated ‘left’ or ‘right’ according to the direction of the initial turn. Procedure turns may be designated as being made either in level flight or while descending, according to the circumstances of each individual procedure;
 - ‘PSR blip’ refers to the visual indication, in a non-symbolic form, on a situation display, of the position of an aircraft obtained by primary radar;

-
- ‘radar approach’ refers to an approach in which the final approach phase is executed under the direction of an air traffic controller using radar;
 - ‘radar clutter’ refers to the visual indication, on a situation display, of unwanted signals;
 - ‘radar contact’ refers to the situation which exists when the radar position of a particular aircraft is seen and identified on a situation display;
 - ‘reporting point’ refers to a specified geographical location in relation to which the position of an aircraft can be reported;
 - ‘runway-holding position’ refers to a designated position intended to protect a runway, an obstacle limitation surface, or an instrument landing system (ILS)/microwave landing system (MLS) critical/sensitive area at which taxiing aircraft and vehicles shall stop and hold unless otherwise authorised by the aerodrome control tower. In radiotelephony phraseologies, the expression ‘holding point’ is used to designate the runway-holding position;
 - ‘runway incursion’ refers to any occurrence at an aerodrome involving the incorrect presence of an aircraft, vehicle or person on the protected area of a surface designated for the landing and take-off of aircraft;
 - ‘runway strip’ refers to a defined area including the runway and stopway, if provided, intended to:
 - (a) reduce the risk of damage to aircraft running off a runway; and
 - (b) protect aircraft flying over it during take-off or landing operations;
 - ‘segregated parallel operations’ refers to simultaneous operations on parallel or near-parallel instrument runways in which one runway is used exclusively for approaches and the other runway is used exclusively for departures;
 - ‘SSR response’ refers to the visual indication, in a non-symbolic form, on a situation display, of a response from an SSR transponder in reply to an interrogation;
 - ‘stopway’ refers to a defined rectangular area on the ground at the end of take-off run available, prepared as a suitable area in which an aircraft can be stopped in the case of an abandoned take-off;
 - ‘total estimated elapsed time’ refers to, for IFR flights, the estimated time required from take-off to arrive over that designated point, defined by reference to navigation aids, from which it is intended that an instrument approach procedure will be commenced, or, if no navigation aid is associated with the destination aerodrome, to arrive over the destination aerodrome. For VFR flights, it refers to the estimated time required from take-off to arrive over the destination aerodrome;
 - ‘touchdown’ refers to the point where the nominal glide path intercepts the runway. ‘Touchdown’ as defined above is only a datum and is not necessarily the actual point at which the aircraft will touch the runway;
 - ‘touchdown zone’ refers to the portion of a runway, beyond the threshold, intended as the first point of contact between landing aircraft and the runway;
 - ‘visual surveillance system’ refers to an electro-optical system providing an electronic visual presentation of traffic and any other information necessary to maintain situational awareness at an aerodrome and its vicinity.
-

ATS.OR.100 Ownership

Regulation (EU) 2017/373

- (a) An air traffic services provider shall notify the competent authorities of:
- (1) its legal status, its ownership structure and any arrangements having a significant impact on control over its assets;
 - (2) any links with organisations not involved in the provision of air navigation services, including commercial activities in which they are engaged either directly or through related undertakings, which account for more than 1 % of their expected revenue; furthermore, it shall notify any change of any single shareholding which represents 10 % or more of their total shareholding.
- (b) An air traffic services provider shall take all necessary measures to prevent any situation of conflict of interests that could compromise the impartial and objective provision of its services.

ATS.OR.105 Open and transparent provision of service

Regulation (EU) 2017/373

In addition to point [ATM/ANS.OR.A.075](#) of [Annex III](#), the air traffic service provider shall neither engage in conduct that would have as its object or effect the prevention, restriction or distortion of competition, nor shall they engage in conduct that amounts to an abuse of a dominant position, in accordance with applicable Union and national law.

ATS.OR.110 Coordination between aerodrome operators and air traffic services providers

Commission Implementing Regulation (EU) 2020/469

An air traffic services provider shall establish arrangements with the operator of the aerodrome at which it provides air traffic services to ensure adequate coordination of activities and services provided as well as exchange of relevant data and information.

AMC1 ATS.OR.110 Coordination between aerodrome operators and air traffic services providers

ED Decision 2020/008/R

ESTABLISHMENT AND IDENTIFICATION OF STANDARD TAXI ROUTES

- (a) The air traffic services provider, in coordination with the aerodrome operator, should assess the necessity for establishing standard routes for taxiing aircraft on an aerodrome between runways, aprons and maintenance areas.
- (b) When established, such routes should be direct, simple and, where practicable, designed to avoid traffic conflicts.
- (c) Standard routes for taxiing aircraft should be identified by designators distinctively different from those of the runways and ATS routes.

AMC2 ATS.OR.110 Coordination between aerodrome operators and air traffic services providers

ED Decision 2020/008/R

INFORMATION EXCHANGE ON THE AERODROME CONDITIONS AND OPERATIONAL STATUS OF AERODROME FACILITIES

The air traffic services provider should establish arrangements with the aerodrome operator for the exchange of information regarding the aerodrome conditions, in particular the operational conditions of the movement area, including the existence of temporary hazards, and the operational status of any associated facilities at the aerodrome(s) with which they are concerned.

AMC3 ATS.OR.110 Coordination between aerodrome operators and air traffic services providers

ED Decision 2020/008/R

APRON MANAGEMENT SERVICES

The air traffic services provider should establish arrangements, including a coordination procedure, with the aerodrome operator and, when applicable, with the other organisation(s) providing apron management services. The coordination procedure between the provider(s) of apron management services and the air traffic services provider should contain at least the following:

- (a) the boundaries of the respective areas of responsibilities as described according to ADR.OPS.D.005 of [Regulation \(EU\) No 139/2014](#);
- (b) the handover points between apron and manoeuvring area;
- (c) the holding areas;
- (d) the means of guidance for the aircraft taxiing;
- (e) the operational information to be exchanged between both parties; and
- (f) the push back operations, when interfering with the manoeuvring area.

AMC4 ATS.OR.110 Coordination between aerodrome operators and air traffic services providers

ED Decision 2020/008/R

COORDINATION FOR LOW-VISIBILITY OPERATIONS

The air traffic services provider should establish arrangements with the aerodrome operator and, where established, with the apron management services provider(s) for the relevant aspects and the definition of the respective responsibilities in conducting low-visibility operations (LVOs), in addition to those established in ATS.TR.265(b)

AMC5 ATS.OR.110 Coordination between aerodrome operators and air traffic services providers

ED Decision 2020/008/R

COORDINATION FOR RUNWAYS INSPECTIONS

The air traffic services provider should coordinate with the aerodrome operator the conduct of routine and non-routine runway inspections.

AMC6 ATS.OR.110 Coordination between aerodrome operators and air traffic services providers

ED Decision 2020/008/R

INFORMATION ON THE SAFE USE OF THE MANOEUVRING AREA

When a not previously notified condition pertaining to the safe use by aircraft of the manoeuvring area is reported to or observed by the aerodrome air traffic controllers or by aerodrome flight information services (AFIS) officers, the air traffic services provider should inform the aerodrome operator, and should ensure that operations on that part of the manoeuvring area are terminated until otherwise advised by the aerodrome operator.

GM1 ATS.OR.110 Coordination between aerodrome operators and air traffic services providers

ED Decision 2020/008/R

COORDINATION FOR THE AERODROME MANUAL

The air traffic services provider should establish close coordination with the aerodrome operator to participate in the development of the elements of the aerodrome manual pertaining to the services it provides.

ATS.OR.115 Coordination between military units and air traffic services providers

Commission Implementing Regulation (EU) 2020/469

Without prejudice to Article 6 of Regulation (EC) No 2150/2005, an air traffic services provider shall ensure that its air traffic services units, either routinely or on request, in accordance with locally agreed procedures, provide appropriate military units with pertinent flight plan and other data concerning flights of civil aircraft in order to facilitate their identification.

ATS.OR.120 Coordination between meteorological services providers and air traffic services providers

Commission Implementing Regulation (EU) 2020/469

- (a) To ensure that aircraft receive the most up-to-date meteorological information for aircraft operations, an air traffic services provider shall make arrangements with the associated meteorological services provider for air traffic services personnel:
- (1) in addition to using indicating instruments, to report, if observed by air traffic services personnel or communicated by aircraft, such other meteorological elements as may be agreed upon;
 - (2) to report as soon as possible meteorological phenomena of operational significance, if observed by air traffic services personnel or communicated by aircraft, which have not been included in the aerodrome meteorological report;
 - (3) to report as soon as possible pertinent information concerning pre-eruption volcanic activity, volcanic eruptions and information concerning volcanic ash cloud. In addition, area control centres and flight information centres shall report the information to the associated meteorological watch office and volcanic ash advisory centres (VAACs).
- (b) An air traffic services provider shall ensure that close coordination is maintained between area control centres, flight information centres and associated meteorological watch offices such that information on volcanic ash included in NOTAM and SIGMET messages is consistent.

ATS.OR.125 Coordination between aeronautical information services and air traffic services providers

Commission Implementing Regulation (EU) 2020/469

- (a) An air traffic services provider shall provide to the relevant aeronautical information services provider the aeronautical information to be published as necessary to permit the utilisation of such air traffic services.
- (b) To ensure that the aeronautical information services providers obtain information to enable them to provide up-to-date preflight information and to meet the need for in-flight information, an air traffic services provider and aeronautical information services provider shall make arrangements to report to the responsible aeronautical information services provider, with a minimum of delay:
- (1) information on aerodrome conditions;
 - (2) the operational status of associated facilities, services and navigation aids within their area of responsibility;
 - (3) the occurrence of volcanic activity observed by air traffic services personnel or reported by aircraft;
 - (4) any other information considered to be of operational significance.
- (c) Before introducing changes to systems for air navigation under its responsibility, an air traffic services provider shall:

- (1) ensure close coordination with the aeronautical information services provider(s) concerned;
 - (2) take due account of the time needed by the aeronautical information services provider for the preparation, production and issuance of relevant material for promulgation;
 - (3) provide the information in a timely manner to the aeronautical information services provider concerned.
- (d) An air traffic services provider shall observe the predetermined, internationally agreed aeronautical information regulation and control (AIRAC) effective dates in addition to 14 days postage time when submitting to aeronautical information services providers the raw information or data, or both, subject to the AIRAC cycle.

GM1 ATS.OR.125(a) Coordination between aeronautical information services and air traffic services providers

ED Decision 2020/008/R

PUBLICATION OF REDUCED RUNWAY SEPARATION MINIMA

The air traffic services provider should arrange to publish all applicable procedures related to the application of reduced runway separation minima as in [AMC9 ATS.TR.210\(c\)\(2\)\(i\)](#) in the aeronautical information publication (AIP) and to include them also in the local ATC instructions.

GM2 ATS.OR.125(a) Coordination between aeronautical information services and air traffic services providers

ED Decision 2020/008/R

PROMULGATION OF INFORMATION ON AFIS

The air traffic services provider should arrange to report information regarding the availability of AFIS and related procedures for its inclusion in the relevant parts of the AIP in the same manner as in the case of aerodromes provided with air traffic control service, in accordance with Appendix I to Annex VI (Part-AIS). The information includes but is not limited to the following:

- (a) identification of the aerodrome;
- (b) location and identification of the AFIS unit;
- (c) hours of operation of the AFIS unit. For aerodromes where there is an alternation of the air traffic control service and AFIS provision, hours of operation of both services;
- (d) lateral and vertical limits of the associated airspace;
- (e) language(s) used;
- (f) detailed description of the services provided, including alerting service and, if applicable, use of direction-finding;
- (g) special procedures for application by pilots; and
- (h) any other pertinent information.

GM1 ATS.OR.125(c) Coordination between aeronautical information services and air traffic services providers

ED Decision 2020/008/R

ORIGIN OF AERONAUTICAL INFORMATION

Information to be reported by the air traffic services provider to the AIS provider for the purpose of air traffic services may originate also from other entities, such as the aerodrome operator, the apron management services provider, CNS service providers, etc.

GM1 ATS.OR.125(d) Coordination between aeronautical information services and air traffic services providers

ED Decision 2020/008/R

Of particular importance are changes to aeronautical information that affect charts and/or computer-based navigation systems which qualify to be notified by the aeronautical information regulation and control (AIRAC) system, as stipulated in [AIS.OR.505](#) and [AIS.TR.505](#).

ATS.OR.127 Coordination by air traffic services providers in U-space airspace

Regulation (EU) 2021/665

Air traffic services providers shall:

- (a) provide on a non-discriminatory basis the relevant traffic information regarding manned aircraft that is necessary as part of the common information services referred to in Commission Implementing [Regulation \(EU\) 2021/664](#) for a U-Space airspace established in the controlled airspace where the air traffic service provider is designated to provide its services;
- (b) establish the coordination procedures and communication facilities between appropriate air traffic service units, U-space service providers and, where applicable, single common information service providers permitting provision of this data.

AMC1 ATS.OR.127(a) Coordination by air traffic services providers in U-space airspace

ED Decision 2022/023/R

INFORMATION ON MANNED AIRCRAFT

Air traffic services providers should make arrangements with operators of manned special operations, which are exempted from the requirements on flight plan submission time according to point SERA.4001(d), to receive the earliest possible notification of an intended manned operation, either directly or through common information services when a single common information service provider is designated.

ATS.OR.130 Time in air traffic services

Commission Implementing Regulation (EU) 2020/469

- (a) An air traffic services provider shall ensure that air traffic services units are equipped with clocks indicating the time in hours, minutes and seconds, clearly visible from each operating position in the unit concerned.
- (b) An air traffic services provider shall ensure that air traffic services unit clocks and other time-recording devices are checked as necessary to ensure correct time to within plus or minus 30 seconds of UTC. Wherever data link communications are utilised by an air traffic services unit, clocks and other time-recording devices shall be checked as necessary to ensure correct time to within 1 second of UTC.
- (c) The correct time shall be obtained from a standard time station or, if not possible, from another unit which has obtained the correct time from such station.

ATS.OR.135 Contingency arrangements

Commission Implementing Regulation (EU) 2020/469

An air traffic services provider shall develop contingency plans as required in point ATM/ANS.OR.A.070 of Annex III in close coordination with the air traffic services providers responsible for the provision of services in adjacent portions of airspace and, as appropriate, with airspace users concerned.

GM1 ATS.OR.135 Contingency arrangements

ED Decision 2020/008/R

The various circumstances surrounding each ATS contingency situation preclude the establishment of exact detailed procedures to be followed.

GM2 ATS.OR.135 Contingency arrangements

ED Decision 2020/008/R

RADIO COMMUNICATION CONTINGENCIES IN AIR TRAFFIC CONTROL SERVICE

- (a) General

Air traffic control contingencies related to communications, i.e. circumstances preventing an air traffic controller from communicating with aircraft under control, may be caused by either a failure of ground radio equipment, a failure of airborne equipment, or by the control frequency being inadvertently blocked by an aircraft or a ground transmitter, or any unauthorised use. The duration of such events may be for prolonged periods and appropriate action to ensure that the safety of aircraft is not affected should therefore be taken immediately.
- (b) Complete ground radio failure
 - (1) In the event of complete failure of the ground radio equipment used for air traffic control service, the air traffic controller should:
 - (i) attempt to establish radio communications on the emergency frequency 121.500 MHz;

- (ii) without delay inform all adjacent control positions or air traffic control units, as applicable, of the failure;
- (iii) apprise such positions or units of the current traffic situation;
- (iv) request their assistance, in respect of aircraft which may establish communications with those positions or units, in establishing and maintaining separation between such aircraft; and
- (v) instruct adjacent control positions or air traffic control units to hold or re-route all controlled flights outside the area of responsibility of the position or air traffic control unit that has experienced the failure until such time that the provision of normal services can be resumed,

unless able to continue to provide air traffic services by means of other available communication channels.

- (2) In order to reduce the impact of complete ground radio equipment failure on the safety of air traffic, the air traffic services provider should establish contingency procedures to be followed by control positions and air traffic control units in the event of such failures. Where agreed between affected air traffic services providers, such contingency procedures should provide for the delegation of control to an adjacent control position or air traffic control unit in order to permit a minimum level of services to be provided as soon as possible, following the ground radio failure and until normal operations can be resumed.

(c) Blocked frequency

In the event that the control frequency is inadvertently blocked by an aircraft transmitter, the following additional steps should be taken:

- (1) attempt to identify the aircraft concerned;
- (2) if the aircraft blocking the frequency is identified, attempts should be made to establish communication with that aircraft, e.g. on the emergency frequency 121.500 MHz, by SELCAL, through the aircraft operator's company frequency if applicable, on any VHF frequency designated for air-to-air use by flight crews or any other communication means or, if the aircraft is on the ground, by direct contact; and
- (3) if communication is established with the aircraft concerned, the flight crew should be instructed to take immediate action to stop inadvertent transmissions on the affected control frequency.

(d) Unauthorised use of ATC frequency

Instances of false and deceptive transmissions on air traffic control frequencies which may impair the safety of aircraft can occasionally occur. In the event of such occurrences, the air traffic control unit concerned should:

- (1) correct any false or deceptive instructions or clearances which have been transmitted;
- (2) advise all aircraft on the affected frequency(ies) that false and deceptive instructions or clearances are being transmitted;
- (3) instruct all aircraft on the affected frequency(ies) to verify instructions and clearances before taking action to comply;

- (4) if practical, instruct aircraft to change to another frequency; and
- (5) if possible, advise all aircraft affected when the false and deceptive instructions or clearances are no longer being transmitted.

GM3 ATS.OR.135 Contingency arrangements

ED Decision 2020/008/R

CONTINGENCY PROCEDURES FOR AIR TRAFFIC SERVICES UNITS WHEN A VOLCANIC ASH CLOUD IS REPORTED OR FORECAST

If a volcanic ash cloud is reported or forecast in the airspace for which the air traffic services unit is responsible, the following actions should be taken, as appropriate:

- (a) relay pertinent information immediately to flight crews whose aircraft could be affected to ensure that they are aware of the ash cloud's current and forecast position and the flight levels affected;
- (b) accommodate requests for re-routing or level changes to the extent practicable;
- (c) suggest re-routing to avoid or exit areas of reported or forecast ash clouds when requested by the pilot or deemed necessary by the air traffic controller; and
- (d) when practicable, request a special air-report when the route of flight takes the aircraft into or near the forecast ash cloud and provide such special air-reports to the appropriate agencies.

GM4 ATS.OR.135 Contingency arrangements

ED Decision 2020/008/R

Guidance on contingency planning for air navigation services providers, including air traffic services providers, may be found in:

- (a) ICAO Annex 11 - Attachment C 'Material relating to contingency planning'; and
- (b) the 'EUROCONTROL Guidelines for Contingency Planning of Air Navigation Services (including Service Continuity)' Edition 2.0 of 06/04/2009, available at:

<https://www.eurocontrol.int/sites/default/files/article/content/documents/nm/safety/safety-guidelines-contingency-planning-ans-2009.pdf>,

and in its complementary document named 'Reference Guide to EUROCONTROL Guidelines for Contingency Planning of Air Navigation Services (including Service Continuity)' Edition 2.0 of 06/04/2009, available at:

<https://www.eurocontrol.int/publication/eurocontrol-guidelines-contingency-planning-air-navigation-services>

ATS.OR.140 Failure and irregularity of systems and equipment

Commission Implementing Regulation (EU) 2020/469

An air traffic services provider shall establish appropriate arrangements for air traffic services units to immediately report any failure or irregularity of communication, navigation and surveillance systems or any other safety-significant systems or equipment which could adversely affect the safety or efficiency of flight operations or the provision of air traffic services, or both.

GM1 ATS.OR.140 Failure and irregularity of systems and equipment

ED Decision 2020/008/R

[ATS.OR.140](#) is complementary to the existing requirements on reporting stemming from [Regulation \(EU\) No 376/2014](#) and on the reporting arrangements that ATM/ANS providers have to establish in accordance with principles and requirements on the management system set in [ATM/ANS.OR.B.005](#) in Annex III to Regulation (EU) 2017/373. However, the primary objective of ATS.OR.140 is the timely dissemination of information needed for the safe and efficient air traffic control service and flight information service provision (e.g. information on changes in the availability of radio navigation services). The arrangements should also support the timely issuance of NOTAMs concerning the relevant information to be disseminated, in accordance with the applicable requirements in [ATM/ANS.OR.A.085](#) in Annex III to [Regulation \(EU\) 2017/373](#).

ATS.OR.145 Operation of air traffic control service

Commission Implementing Regulation (EU) 2020/469

An air traffic services provider shall ensure that information on aircraft movements, together with a record of ATC clearances issued to such aircraft, are so displayed as to permit ready analysis in order to maintain an efficient flow of air traffic with adequate separation between aircraft.

AMC1 ATS.OR.145 Operation of air traffic control service

ED Decision 2020/008/R

PRESENTATION AND UPDATING OF FLIGHT PLAN AND CONTROL DATA AND OTHER RELEVANT INFORMATION FOR THE AIR TRAFFIC CONTROL SERVICE PROVISION

- (a) The air traffic services provider should ensure that sufficient information and data are presented in such a manner as to enable the air traffic controller to have a complete representation of the current air traffic situation within the air traffic controller's area of responsibility and, when relevant, movements on the manoeuvring area of aerodromes.
- (b) The presentation should be updated in accordance with the progress of aircraft in order to facilitate the timely detection and resolution of conflicts as well as to facilitate and provide a record of coordination with adjacent air traffic services units and control sectors.
- (c) An appropriate representation of the airspace configuration, including significant points and information related to such points, should be provided.
- (d) Data to be presented should include relevant information from flight plans and position reports as well as clearance and coordination data.
- (e) The information display may be generated and updated automatically, or the data may be entered and updated by authorised personnel.
- (f) Data generated automatically should be presented to the air traffic controller in a timely manner. The presentation of information and data for individual flights should continue until such time as the data is no longer required for the purpose of providing control, including conflict detection and the coordination of flights, or until terminated by the air traffic controller.
- (g) All information and data as in point (a), including data related to individual aircraft, should be presented in a manner minimising the potential for misinterpretation or misunderstanding.

GM1 ATS.OR.145 Operation of air traffic control

ED Decision 2020/008/R

PRESENTATION AND UPDATING OF FLIGHT PLAN AND CONTROL DATA AND OTHER RELEVANT INFORMATION FOR THE AIR TRAFFIC CONTROL SERVICE PROVISION

Human factors principles should be considered when establishing the provisions and procedures stipulated in ATS.OR.145. The SESAR Joint Undertaking has developed a project titled 'Human Performance in Automation Support' (Project Nr. 16.05), which addressed the subject. The relevant final Project Report may be found at https://www.sesarju.eu/sites/default/files/DEL_16.05-D09-Final_Project_Report_00.01.00.pdf.

GM2 ATS.OR.145 Operation of air traffic control service

ED Decision 2020/008/R

PRESENTATION AND UPDATING OF FLIGHT PLAN AND CONTROL DATA AND OTHER RELEVANT INFORMATION FOR THE AIR TRAFFIC CONTROL SERVICE PROVISION

Other information required or desirable for the air traffic control service provision may be but is not limited to:

- (a) relevant meteorological information;
- (b) NOTAMs;
- (c) airspace-related information;
- (d) status of radio navigation services and visual aids;
- (e) aerodrome conditions and the operational status of associated facilities, where appropriate;
- (f) unmanned free balloons; and
- (g) others.

GM3 ATS.OR.145 Operation of air traffic control service

ED Decision 2020/008/R

PRESENTATION AND UPDATING OF FLIGHT PLAN AND CONTROL DATA AND OTHER RELEVANT INFORMATION FOR THE AIR TRAFFIC CONTROL SERVICE PROVISION

- (a) The required flight plan and control data may be presented through the use of paper flight progress strips or electronic flight progress strips, by other electronic presentation forms or by a combination of presentation methods.
- (b) The air traffic services provider should specify the procedures for annotating data and provisions specifying the types of data to be entered on flight progress strips, including the use of symbols.

ATS.OR.150 Transfer of responsibility for control and transfer of communications

Commission Implementing Regulation (EU) 2020/469

Air traffic services provider shall establish applicable coordination procedures for transfer of responsibility for control of flights, including transfer of communications and transfer of control points, in letters of agreement and operation manuals, as appropriate.

GM1 ATS.OR.150 Transfer of responsibility for control and transfer of communications

ED Decision 2020/008/R

GUIDANCE ON LETTERS OF AGREEMENT BETWEEN AIR TRAFFIC SERVICES UNITS

Guidance on the drafting of operational Letters of Agreement between air traffic services units may be found in the EUROCONTROL Guidelines ‘Common Format Letter of Agreement

Between Air Traffic Services Units’ Edition 5.0 of 15.10.2019, available at <https://www.eurocontrol.int/publication/common-format-letter-agreement-between-air-traffic-services-units>.

GM2 ATS.OR.150 Transfer of responsibility for control and transfer of communications

ED Decision 2020/008/R

TRANSFER OF COMMUNICATION

- (a) Except when separation minima based on ATS surveillance systems specified in [AMC1 ATS.TR.210\(c\)\(2\)](#), [AMC6 ATS.TR.220](#) and point (d) of [AMC7 ATS.TR.220](#) are being applied, the transfer of air-ground communications of an aircraft from the transferring to the accepting control unit should be made 5 minutes before the time at which the aircraft is estimated to reach the common control area boundary unless otherwise agreed between the two air traffic control units concerned.
- (b) Between two air traffic services units applying separation minima based on ATS surveillance systems specified in [AMC1 ATS.TR.210\(c\)\(2\)](#), [AMC6 ATS.TR.220](#) and point (d) of [AMC7 ATS.TR.220](#) at the time of transfer of control, the transfer of air-ground communications of an aircraft from the transferring to the accepting control unit should be made immediately after the accepting control unit has agreed to assume control.
- (c) The transfer of air-ground communications to the aerodrome air traffic controller should be effected at such a point, level, or time, that clearance to land or alternative instructions, as well as information on essential local traffic, can be issued in a timely manner.
- (d) The accepting control unit should notify the transferring unit in the event that communication with the aircraft is not established as expected.
- (e) In cases where a portion of a control area is so situated that the time taken by aircraft to traverse it is of a limited duration, agreement should be reached to provide for direct transfer of communication between the units responsible for the adjacent control areas, provided that the intermediate unit is fully informed of such traffic. The intermediate unit should retain

responsibility for coordination and for ensuring that separation is maintained between all traffic within its area of responsibility.

- (f) An aircraft may be permitted to communicate temporarily with a control unit other than the unit controlling the aircraft.

SECTION 2 — SAFETY OF SERVICES

ATS.OR.200 Safety management system

Regulation (EU) 2017/373

An air traffic services provider shall have in place a safety management system (SMS), which may be an integral part of the management system required in point [ATM/ANS.OR.B.005](#), that includes the following components:

- (1) *Safety policy and objectives*
 - (i) Management commitment and responsibility regarding safety which shall be included in the safety policy.
 - (ii) Safety accountabilities regarding the implementation and maintenance of the SMS and the authority to make decisions regarding safety.
 - (iii) Appointment of a safety manager who is responsible for the implementation and maintenance of an effective SMS;
 - (iv) Coordination of an emergency response planning with other service providers and aviation undertakings that interface with the ATS provider during the provision of its services.
 - (v) SMS documentation that describes all the elements of the SMS, the associated SMS processes and the SMS outputs.
- (2) *Safety risk management*
 - (i) A process to identify hazards associated to its services which shall be based on a combination of reactive, proactive and predictive methods of safety data collection.
 - (ii) A process that ensures analysis, assessment and control of the safety risks associated with identified hazards.
 - (iii) A process to ensure that its contribution to the risk of aircraft accidents is minimised as far as is reasonably practicable.
- (3) *Safety assurance*
 - (i) Safety performance monitoring and measurement means to verify the safety performance of the organisation and validate the effectiveness of the safety risk controls.
 - (ii) A process to identify changes which may affect the level of safety risk associated with its service and to identify and manage the safety risks that may arise from those changes.
 - (iii) A process to monitor and assess the effectiveness of the SMS to enable the continuous improvement of the overall performance of the SMS.
- (4) *Safety promotion*
 - (i) Training programme that ensures that the personnel are trained and competent to perform their SMS duties.
 - (ii) Safety communication that ensures that the personnel are aware of the SMS implementation.

AMC1 ATS.OR.200(1); (2); (3) Safety management system*ED Decision 2017/001/R***GENERAL — NON-COMPLEX ATS PROVIDERS**

- (a) The safety policy should include a commitment to improve towards the highest safety standards, comply with all the applicable legal requirements, meet all the applicable standards, consider the best practices and provide the appropriate resources.
- (b) In cooperation with other stakeholders, the air traffic services provider should develop, coordinate and maintain an emergency response plan (ERP) that ensures orderly and safe transition from normal to emergency operations and return to normal operations. The ERP should determine the actions to be taken by the air traffic services provider or specified individuals in an emergency and reflect the size, nature and complexity of the activities performed by the air traffic services provider.
- (c) Safety risk management may be performed using hazard checklists or similar risk management tools or processes, which are integrated into the activities of the air traffic services provider.
- (d) An air traffic services provider should manage safety risks related to changes. Management of changes should be a documented process to identify external and internal changes that may have an adverse effect on safety. It should make use of the air traffic services provider's existing hazard identification, risk assessment and mitigation processes.
- (e) An air traffic services provider should identify persons who fulfil the role of safety managers and who are responsible for coordinating the safety management system (SMS). These persons may be accountable managers or individuals with an operational role in the air traffic services provider.
- (f) Within the air traffic services provider, responsibilities should be identified for hazard identification, risk assessment and mitigation.

AMC1 ATS.OR.200(1)(i) Safety management system*ED Decision 2017/001/R***SAFETY POLICY — COMPLEX ATS PROVIDERS**

- (a) The safety policy should:
 - (1) be signed by the accountable manager;
 - (2) reflect organisational commitments regarding safety and its proactive and systematic management;
 - (3) be communicated, with visible endorsement, throughout the air traffic services provider;
 - (4) include safety reporting principles;
 - (5) include a commitment to:
 - (i) improve towards the highest safety standards;
 - (ii) comply with all the applicable legal requirements, meet all the applicable standards and consider the best practices;
 - (iii) provide appropriate resources; and
 - (iv) enforce safety as one primary responsibility of all managers and staff;

- (6) include the safety reporting procedures;
 - (7) clearly indicate which types of operational behaviours are unacceptable, and include the conditions under which disciplinary action would not apply; and
 - (8) be periodically reviewed to ensure it remains relevant and appropriate.
- (b) Senior management should:
- (1) continually promote the safety policy to all personnel and demonstrate their commitment to it;
 - (2) provide necessary human and financial resources for its implementation; and
 - (3) establish safety objectives and performance standards.

GM1 ATS.OR.200(1)(i) Safety management system

ED Decision 2017/001/R

SAFETY POLICY — COMPLEX ATS PROVIDERS

Operational behaviour, when disciplinary action would not apply, could be where someone is not blamed for reporting something which would not have been otherwise detected.

GM2 ATS.OR.200(1)(i) Safety management system

ED Decision 2017/001/R

SAFETY POLICY — COMPLEX ATS PROVIDERS

- (a) The safety policy should state that the purpose of safety reporting and internal investigations is to improve safety, not to apportion blame to individuals.
- (b) An air traffic services provider may combine the safety policy with the policy required by [ATM/ANS.OR.B.005\(a\)\(2\)](#).

GM3 ATS.OR.200(1)(i) Safety management system

ED Decision 2017/001/R

SAFETY POLICY — NON-COMPLEX ATS PROVIDERS

- (a) The safety policy should state that the purpose of safety reporting is to improve safety, not to apportion blame to individuals.
- (b) An air traffic services provider may combine the safety policy with the policy required by [ATM/ANS.OR.B.005\(a\)\(2\)](#).

AMC1 ATS.OR.200(1)(ii) Safety management system

ED Decision 2017/001/R

ACCOUNTABILITIES — COMPLEX ATS PROVIDERS

The SMS of the air traffic services provider should ensure that:

- (a) everyone involved in the safety aspects of the provision of air traffic services has an individual safety responsibility for their own actions;

- (b) managers should be responsible for the safety performance of their respective departments or divisions; and
- (c) the top management of the provider carries an overall safety responsibility.

GM1 ATS.OR.200(1)(ii) Safety management system

ED Decision 2017/001/R

SAFETY ACTION GROUP — COMPLEX ATS PROVIDERS

- (a) A safety action group may be established as a standing group or as an ad hoc group to assist or act on behalf of the safety review board as defined in point (b) of [AMC2 ATS.OR.200\(1\)\(ii\);\(iii\)](#).
- (b) More than one safety action group may be established depending on the scope of the task and the specific expertise required.
- (c) The safety action group should report to and take strategic direction from the safety review board and should comprise managers, supervisors and personnel from operational areas.
- (d) The safety action group should:
 - (1) monitor operational safety;
 - (2) resolve identified risks;
 - (3) assess the impact on safety of operational changes; and
 - (4) ensure that safety actions are implemented within agreed timescales.
- (e) The safety action group should review the effectiveness of previous safety recommendations and safety promotion.
- (f) Members of the safety action group should participate in the local runway safety team as per [GM2 ADR.OR.D.027](#) 'Safety programmes'.

AMC1 ATS.OR.200(1)(ii);(iii) Safety management system

ED Decision 2017/001/R

ORGANISATION AND ACCOUNTABILITIES

An air traffic service provider should:

- (a) identify the safety manager who, irrespective of other functions, has ultimate responsibility and accountability, on behalf of the organisation, for the implementation and maintenance of the SMS;
- (b) clearly define lines of safety accountability throughout the organisation, including a direct accountability for safety on the part of senior management;
- (c) identify the accountabilities of all members of management, irrespective of other functions, as well as of employees, with respect to the safety performance of the SMS;
- (d) document and communicate safety responsibilities, accountabilities and authorities throughout the organisation; and
- (e) define the levels of management with authority to make decisions regarding safety risk tolerability.

AMC2 ATS.OR.200(1)(ii);(iii) Safety management system

ED Decision 2017/001/R

ORGANISATION AND ACCOUNTABILITIES — COMPLEX ATS PROVIDERS

The SMS of the air traffic services provider should encompass safety by including a safety manager and a safety review board in the organisational structure.

(a) Safety manager

- (1) The safety manager should act as the focal point and be responsible for the development, administration and maintenance of an effective SMS. He or she should be independent of line management, and accountable directly to the highest organisational level.
- (2) The role of the safety manager should, as a minimum, be to:
 - (i) ensure that hazard identification, risk analysis and management are undertaken in accordance with the SMS processes;
 - (ii) monitor the implementation of actions taken to mitigate risks;
 - (iii) provide periodic reports on safety performance;
 - (iv) ensure maintenance of safety management documentation;
 - (v) ensure that there is safety management training available and that it meets acceptable standards;
 - (vi) provide advice on safety matters; and
 - (vii) monitor initiation and follow-up of internal occurrence/accident investigations.
- (3) The safety manager should have:
 - (i) adequate practical experience and expertise in air traffic services or a similar area;
 - (ii) adequate knowledge of safety and quality management;
 - (iii) adequate knowledge of the working methods and operating procedures; and
 - (iv) comprehensive knowledge of the applicable requirements in the area of air traffic services.

(b) Safety review board

- (1) The safety review board should be a high-level committee that considers matters of strategic safety in support of the accountable manager's safety accountability.
- (2) The board should be chaired by the accountable manager and composed of heads of functional areas.
- (3) The safety review board should, as a minimum:
 - (i) monitor safety performance against safety policy and objectives;
 - (ii) ensure that any safety action is taken in a timely manner; and
 - (iii) monitor the effectiveness of the air traffic services provider's SMS processes.
- (4) The safety review board should ensure that appropriate resources are allocated to achieve the planned safety performance.

- (5) The safety manager or any other relevant person may attend, as appropriate, safety review board meetings. He or she may communicate to the accountable manager all information, as necessary, to allow decision-making based on safety data.

GM1 ATS.OR.200(1)(iii) Safety management system

ED Decision 2017/001/R

SAFETY MANAGER — COMPLEX ATS PROVIDERS

- (a) Depending on the size of the air traffic services provider and the nature and complexity of their activities, the safety manager may be assisted by additional safety personnel in the performance of all the safety-management-related tasks.
- (b) Regardless of the organisational set-up, it is important that the safety manager remains the unique focal point as regards the development, administration and maintenance of the air traffic services provider's SMS.

GM2 ATS.OR.200(1)(iii) Safety management system

ED Decision 2017/001/R

SAFETY MANAGER — NON-COMPLEX AIR TRAFFIC SERVICES PROVIDERS

In the case of a non-complex air traffic services provider, the function of the safety manager could be combined with another function within the organisation provided that sufficient independence is guaranteed.

AMC1 ATS.OR.200(1)(iv) Safety management system

ED Decision 2017/001/R

COORDINATION OF EMERGENCY RESPONSE PLANNING FOR ATS PROVIDERS — COMPLEX ATS PROVIDERS

- (a) An air traffic services provider should develop, coordinate and maintain a plan for its response to an emergency. It should:
- (1) reflect the nature and complexity of the activities performed by the air traffic services provider;
 - (2) ensure an orderly and safe transition from normal to emergency operations;
 - (3) ensure safe continuation of operations or return to normal operations as soon as practicable; and
 - (4) ensure coordination with the ERPs of other organisations, where appropriate.
- (b) For emergencies occurring at the aerodrome or in its surroundings, the plan should be aligned with the aerodrome ERP and be coordinated with the aerodrome operator.

GM1 ATS.OR.200(1)(iv) Safety management system

ED Decision 2017/001/R

TYPES OF EMERGENCIES

At least the following types of emergencies may be considered:

- (a) aircraft emergencies;

- (b) natural phenomena (e.g. extreme weather conditions);
- (c) acts of terrorism;
- (d) loss of the ability to communicate with the aircraft; and
- (e) loss of the air traffic services unit.

GM2 ATS.OR.200(1)(iv) Safety management system

ED Decision 2017/001/R

COORDINATION OF THE EMERGENCY RESPONSE PLANNING FOR ATS PROVIDERS — COMPLEX ATS PROVIDERS

For aerodrome-related emergencies, please refer to [GM4 ADR.OPS.B.005\(a\)](#) 'Aerodrome Emergency Planning'.

AMC1 ATS.OR.200(1)(v) Safety management system

ED Decision 2017/001/R

SAFETY MANAGEMENT MANUAL (SMM) — COMPLEX ATS PROVIDERS

The safety management manual should be the key instrument for communicating the approach to safety for the air traffic services provider. The SMM should document all aspects of safety management, including but not limited to the:

- (a) scope of the SMS;
- (b) safety policy and objectives;
- (c) safety accountability of the accountable manager;
- (d) safety responsibilities, accountabilities and authorities of key safety personnel throughout the air traffic services provider;
- (e) documentation control procedures;
- (f) hazard identification and safety risk management schemes;
- (g) safety performance monitoring;
- (h) incident investigation and reporting;
- (i) emergency response planning;
- (j) management of change (including organisational changes with regard to safety responsibilities and changes to functional systems); and
- (k) safety promotion.

AMC2 ATS.OR.200(1)(v) Safety management system

ED Decision 2017/001/R

SAFETY RECORDS — COMPLEX ATS PROVIDERS

Safety records that should be maintained and retained include but are not limited to:

- (a) certificates;
- (b) limited certificates;

- (c) declarations;
- (d) safety policy;
- (e) safety accountabilities/responsibilities;
- (f) safety occurrences;
- (g) emergency response plan;
- (h) SMS documentation;
- (i) training and competence;
- (j) occurrence reports;
- (k) safety risk assessments including safety assessment of changes to the functional system;
- (l) determination of either complex or non-complex organisation; and
- (m) approved alternative means of compliance.

GM1 ATS.OR.200(1)(v) Safety management system

ED Decision 2017/001/R

SAFETY MANAGEMENT MANUAL (SMM) — COMPLEX ATS PROVIDERS

The SMM may be contained in (one of) the manual(s) of the air traffic services provider.

GM1 ATS.OR.200(3)(i) Safety management system

ED Decision 2017/001/R

SAFETY ASSURANCE — COMPLEX ATS PROVIDERS

- (a) Leading indicators
 - (1) Metrics that measure inputs to the safety system (either within an organisation, a sector or across the total aviation system) to manage and improve safety performance.
 - (2) Leading indicators measure the specific features of the aviation safety system designed to support continuous improvement and to give an indication of likely future safety performance. They are designed to help identify whether the providers and regulators are taking actions and/or have processes in place that are effective in lowering the risk.
- (b) Lagging indicators

Metrics that measure the outcome of the service delivery by measuring events that have already occurred and that impact safety performance. There are two subsets of lagging indicators:

 - (1) Outcome indicators: These include only the occurrences that one aims to prevent, for example fatal or catastrophic accidents. Depending on the system, the severity of the occurrences that are included as outcome indicators can be adjusted to include all accidents and serious incidents.
 - (2) Precursor indicators: These indicators do not manifest themselves in accidents or serious incidents. They indicate less severe system failures or 'near misses', and are used to assess how frequently the system comes close to severe failure. Because they are typically more numerous than outcome indicators, they can be used for trend monitoring.

(c) Safety management system

In the case of a complex air traffic services provider, the SMS should include all of these measures. Risk management efforts, however, should be targeted at leading indicators and precursor events. The reason for doing this is to reduce the number of accidents and serious incidents.

(d) Differing levels of safety performance monitoring

(1) Measurements of safety in terms of undesirable events, such as accidents and incidents, are examples of ‘lagging indicators’, which can capture safety performance a posteriori. Such indicators give valuable signals to all involved in air traffic services — providers, regulators, and recipients — of the levels of safety being experienced and of the ability of the organisations concerned to take appropriate mitigation action.

However, other types of measurement — ‘leading indicators’ — can give a wider perspective of the safety ‘health’ of the functional system, and focus on systemic issues, such as safety maturity and SMS performance.

(2) A holistic approach to performance monitoring is an essential input to decision-making with regard to safety. It is important to ensure that good safety performance is attributable to good performance of the SMS, not simply to lack of incidents or accidents. It is also essential that the metrics chosen match the requirements of the stakeholders and decision-makers involved in safety improvement.

(3) As shown in the diagram, stakeholders in the wider aviation industry and the general public require relatively small numbers of safety indicators (safety performance indicators or key performance indicators) which can give an instant ‘feel’ for the overall position regarding safety performance. Conversely, those involved in the management of services concerned need a more detailed set of metrics on which to base decisions regarding the management of the services and facilities being reviewed.

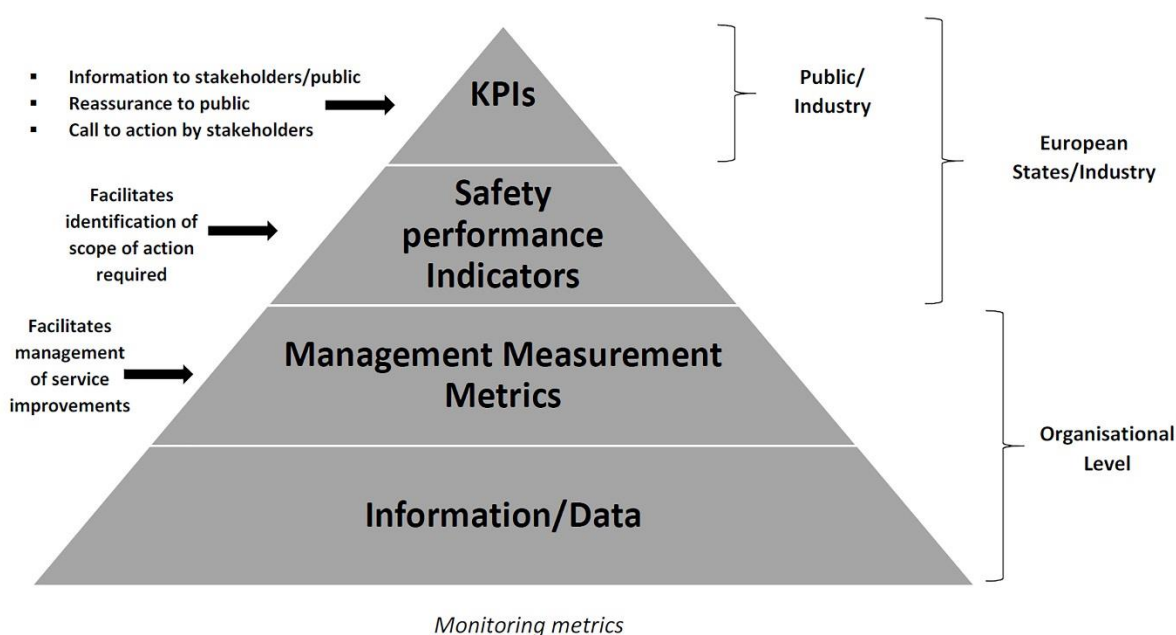

AMC1 ATS.OR.200(3)(iii) Safety management system

ED Decision 2017/001/R

CONTINUOUS IMPROVEMENT OF THE SMS — COMPLEX ATS PROVIDERS

An air traffic services provider should continuously improve the effectiveness of its SMS by:

- (a) developing and maintaining a formal process to identify the causes of substandard performance of the SMS;
- (b) establishing one or more mechanisms to determine the implications of substandard performance of the SMS;
- (c) establishing one or more mechanisms to eliminate or mitigate the causes of substandard performance of the SMS; and
- (d) developing and maintaining a process for the proactive evaluation of facilities, equipment, documentation, processes and procedures (through internal audits, surveys, etc.).

GM1 ATS.OR.200(3)(iii) Safety management system

ED Decision 2017/001/R

CONTINUOUS IMPROVEMENT OF THE SMS — COMPLEX ATS PROVIDERS

- (a) Substandard performance of the SMS can manifest itself in two ways. Firstly, where the SMS processes themselves do not fit their purpose (e.g. not adequately enabling the air traffic services provider to identify, manage and mitigate hazards and their associated risks) resulting in the safety performance of the service being impacted in a negative way. Secondly, where the SMS processes fit their purpose, but are not applied correctly or adequately by the personnel whose safety accountabilities and responsibilities are discharged through the application of the SMS. Personnel who have safety accountabilities and responsibilities are considered an essential part of the effectiveness of the SMS and viewed as part of the SMS.
- (b) Therefore, by detecting substandard performance of the SMS, the air traffic services provider can take action to improve the SMS processes themselves or to improve the application of the SMS processes by those with safety accountabilities and responsibilities resulting in an improvement to the safety performance.
- (c) Continuous improvement of the effectiveness of the safety management processes can be achieved through:
 - (1) proactive and reactive evaluations of facilities, equipment, documentation, processes and procedures through safety audits and surveys; and
 - (2) reactive evaluations in order to verify the effectiveness of the system for control and mitigation of risks.
- (d) In the same way that continuous improvement is sought through safety performance monitoring and measurement (see [GM1 ATM/ANS.OR.B.005\(a\)\(3\)](#) and [GM1 ATS.OR.200\(3\)\(i\)](#)) by the use of leading and lagging indicators, continuous improvement of the SMS provides the air traffic services provider with safety assurance for the service.

- (e) As with safety performance monitoring, the continuous improvement of the SMS lends itself to a process that can be summarised as:
- (1) Identify where there are potential weaknesses or opportunities for improvement;
 - (2) Identify what goes right and disseminate as best practice;
 - (3) Identify what can be done to tackle weaknesses or lead to improvement;
 - (4) Set performance standards for the actions identified;
 - (5) Monitor performance against the standards;
 - (6) Take corrective actions to improve performance; and
 - (7) Repeat the process by using the continuous improvement model below:

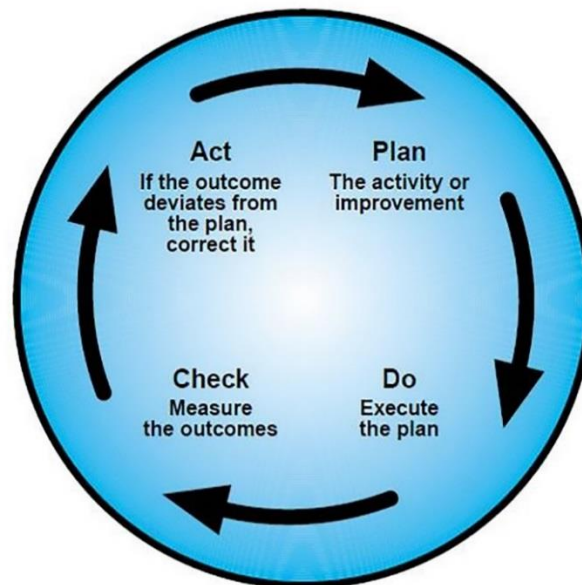

- (f) Taking into account that the SMS is being required to manage safety, it can be assumed that by continuously improving the effectiveness of the SMS, ATS providers should be able to better manage and mitigate, and ultimately control the safety risks associated with the provisions of their services.

AMC1 ATS.OR.200(4)(i) Safety management system

ED Decision 2017/001/R

TRAINING AND COMMUNICATION — COMPLEX ATS PROVIDERS

- (a) Training
- (1) All personnel should receive safety training as appropriate for their safety responsibilities.
 - (2) Adequate records of all safety training provided should be kept.
- (b) Communication
- (1) The ATS provider should establish communication about safety matters that:

- (a) ensures that all personnel are aware of the safety management activities as appropriate for their safety responsibilities;
 - (b) conveys critical information, especially relating to assessed risks and analysed hazards;
 - (c) explains why particular actions are taken; and
 - (d) explains why safety procedures are introduced or changed.
- (2) Regular meetings with personnel where information, actions and procedures are discussed, may be used to communicate safety matters.

GM1 ATS.OR.200(4)(i) Safety management system

ED Decision 2017/001/R

TRAINING — COMPLEX ATS PROVIDERS

The safety training programme may consist of self-instruction (e.g. newsletters, flight safety magazines), classroom training, e-learning or similar training provided by training organisations.

ATS.OR.205 Safety assessment and assurance of changes to the functional system

Regulation (EU) 2017/373

- (a) For any change notified in accordance with point [ATM/ANS.OR.A.045\(a\)\(1\)](#), the air traffic services provider shall:
- (1) ensure that a safety assessment is carried out covering the scope of the change, which is:
 - (i) the equipment, procedural and human elements being changed;
 - (ii) interfaces and interactions between the elements being changed and the remainder of the functional system;
 - (iii) interfaces and interactions between the elements being changed and the context in which it is intended to operate;
 - (iv) the life cycle of the change from definition to operations including transition into service;
 - (v) planned degraded modes of operation of the functional system; and
 - (2) provide assurance, with sufficient confidence, via a complete, documented and valid argument that the safety criteria identified via the application of point [ATS.OR.210](#) are valid, will be satisfied and will remain satisfied.
- (b) An air traffic services provider shall ensure that the safety assessment referred to in point (a) comprises:
- (1) the identification of hazards;
 - (2) the determination and justification of the safety criteria applicable to the change in accordance with point [ATS.OR.210](#);
 - (3) the risk analysis of the effects related to the change;

- (4) the risk evaluation and, if required, risk mitigation for the change such that it can meet the applicable safety criteria;
- (5) the verification that:
 - (i) the assessment corresponds to the scope of the change as defined in point (a)(1);
 - (ii) the change meets the safety criteria;
- (6) the specification of the monitoring criteria necessary to demonstrate that the service delivered by the changed functional system will continue to meet the safety criteria.

GM1 ATS.OR.205(a)(1) Safety assessment and assurance of changes to the functional system

ED Decision 2017/001/R

GENERAL

- (a) The safety assessment should be conducted by the air traffic services provider itself. It may also be carried out by another organisation, on its behalf, provided that the responsibility for the safety assessment remains with the air traffic services provider.
- (b) A safety assessment needs to be performed when a change affects a part of the functional system managed by the provider of air traffic services and that is being used in the provision of its (air traffic) services. The safety assessment or the way it is conducted does not depend on whether the change is a result of a business decision or a decision to improve safety.

GM2 ATS.OR.205(a)(1) Safety assessment and assurance of changes to the functional system

ED Decision 2017/001/R

SCOPE OF THE CHANGE

- (a) The description of the elements being changed includes the nature, functionality, location, performance, maintenance tasks, training and responsibilities of these elements, where applicable. The description of interfaces and interactions, between machines and between humans and machines, should include communication means, e.g. language, phraseology, protocol, format, order and timing and transmission means, where applicable. In addition, it includes the description of the context in which they operate.
- (b) There are two main aspects to consider in evaluating the scope of a change:
 - (1) The interactions within the changed functional system;
 - (2) The interactions within the changing functional system, i.e. those that occur during transitions from the current functional system to the changed functional system. During such transitions, components are replaced/installed in the functional system. These installation activities are interactions within the changing functional system and are to be included within the scope of the change.

As each transition can be treated as a change to the functional system, the identification of both the above has a common approach described below.

- (c) The scope of the change is defined as the set of the changed components and affected components. In order to identify the affected components and the changed components, it is necessary to:
- (1) know which components will be changed;
 - (2) know which component's (components') behaviour might be directly affected by the changed components, although it is (they are) not changed itself (themselves);
 - (3) detect indirectly affected components by identifying:
 - (i) new interactions introduced by the changed or directly affected components; and/or
 - (ii) interactions with changed or directly affected components via the environment.
 - (4) Furthermore, directly and indirectly affected components will be identified as a result of applying the above iteratively to any directly and indirectly affected components that have been identified previously.

The scope of the change is the set of changed, directly impacted and indirectly impacted components identified when the iteration identifies no new components.

- (d) The context in which the changed service is intended to operate (see [ATS.OR.205\(a\)\(1\)\(iii\)](#)) includes the interface through which the service will be delivered to its users.

GM3 ATS.OR.205(a)(1) Safety assessment and assurance of changes to the functional system

ED Decision 2017/001/R

TRAINING

If the change modifies the way people interact with the rest of the functional system, then a training might be required before the change becomes operational. Care should be taken when training operational staff before the change is operational, as the training may change the behaviour of the operational staff when they interact with the existing functional system before any other part of the change is made, and so may have to be treated as a transitional stage of the change.

For example, as a result of training, air traffic controllers (ATCOs) may come to expect information or alerts to be presented differently. People may also need refreshment training periodically in order to ensure that their performance does not degrade over time. The training needed before operation forms part of the design of the change, while the refreshment training is part of the maintenance of the functional system after the change is in operation.

GM4 ATS.OR.205(a)(1) Safety assessment and assurance of changes to the functional system

ED Decision 2017/001/R

DESCRIPTION OF THE SCOPE — 'MULTI-ACTOR CHANGE'

In reference to 'multi-actor change', please refer to [GM1 ATM/ANS.OR.C.005\(b\)\(1\)](#) Safety support assessment and assurance of changes to the functional system.

GM1 ATS.OR.205(a)(1)(iii) Safety assessment and assurance of changes to the functional system

ED Decision 2017/001/R

INTERACTIONS

The identification of changed interactions is necessary in order to identify the scope of the change because any changed behaviour in the system comes about via a changed interaction. Changed interaction happens via an interaction at an interface of the functional system and the context in which it operates. Consequently, identification of both interfaces and interactions is needed to be sure that all interactions have identified interfaces and all interfaces have identified interactions. From this, all interactions and interfaces that will be changed can be identified.

AMC1 ATS.OR.205(a)(2) Safety assessment and assurance of changes to the functional system

ED Decision 2017/001/R

FORM OF ASSURANCE

The air traffic services provider should ensure that the assurance required by [ATS.OR.205\(a\)\(2\)](#) is documented in a safety case.

AMC2 ATS.OR.205(a)(2) Safety assessment and assurance of changes to the functional system

ED Decision 2017/001/R

COMPLETENESS OF THE ARGUMENT

The argument should be considered complete when it shows, as applicable, that:

- (a) the safety assessment in [ATS.OR.205\(b\)](#) has produced a sufficient set of non-contradictory valid safety criteria;
- (b) safety requirements have been placed on the elements changed and on those elements affected by the change;
- (c) the safety requirements as implemented meet the safety criteria;
- (d) all safety requirements have been traced from the safety criteria to the level of the architecture at which they have been satisfied;
- (e) each component satisfies its safety requirements;
- (f) each component operates as intended, without adversely affecting the safety; and
- (g) the evidence is derived from known versions of the components and the architecture and known sets of products, data and descriptions that have been used in the production or verification of those versions.

GM1 to AMC2 ATS.OR.205(a)(2) Safety assessment and assurance of changes to the functional system

ED Decision 2017/001/R

COMPLETENESS OF THE ARGUMENT

(a) Sufficiency of safety criteria

- (1) A sufficient set of safety criteria is one where the safety goal of the change is validly represented by the set of individual safety criteria, each criterion of which must be valid in its own right and not contradict another criterion or any other subset of criteria. A valid criterion is a correct, complete and unambiguous statement of the desired property. An individual valid criterion does not necessarily represent a complete safety criterion. An example of an invalid criterion is that the maximum take-off weight must not exceed 225 Tonnes because weight is measured in Newtons and not in Tonnes. An example of an incomplete criterion is that the accuracy must be 5 m because no reliability attribute is present. This implies it must always be within 5 m, which is impossible in practice.
- (2) Optimally, a sufficient set of criteria would consist of the minimum set of non-overlapping valid criteria and it is preferable to a set containing overlapping criteria.
- (3) Criteria that are not relevant, i.e. ones that do not address the safety goal of the change at all, should be removed from the set as they contribute nothing, may contradict other valid criteria and may serve to confuse.
- (4) There are two forms of overlap: complete overlap and partial overlap.
 - (i) In the first case, one or more criteria can be removed and the set would remain sufficient, i.e. there are unnecessary criteria.
 - (ii) In the second case, (partially overlapping criteria) if any criterion were to be removed, the set would not be sufficient. Consequently, all criteria are necessary; however, validating the set would be much more difficult. Showing that a set of criteria with significant overlap do not contradict each other is extremely difficult and consequently prone to error.
- (5) It may, in fact, be simpler to develop an architecture that supports non-overlapping criteria than to attempt to validate a partially overlapping set of criteria.

(b) Safety requirements

- (1) The safety requirements are design characteristics/items of the functional system to ensure that the system operates as specified. Based on the verification/demonstration of these characteristics/items, it could be concluded that the safety criteria are met.
- (2) The highest layer of safety requirements represents the desired safety behaviour of the change at its interface with the operational context.
- (3) In almost all cases, verification that a system behaves as specified cannot be accomplished, to an acceptable level of confidence, at the level of its interface with its operational environment. To this end, the system verification should be decomposed into verifiable parts, taking into account the following principles:
 - (i) Verification relies on requirements placed on these parts via a hierarchical decomposition of the top level requirements, in accordance with the constraints imposed by the chosen architecture.

-
- (ii) At the lowest level, this decomposition places requirements on elements, where verification that the implementation satisfies its requirements can be achieved by testing.
 - (iii) At higher levels in the architecture, during integration, verified elements of different types are combined into subsystems/components, in order to verify more complete parts of the system.
 - (iv) While they cannot be fully tested, other verification techniques may be used to provide sufficient levels of confidence that these subsystems/components do what they are supposed to do.
 - (v) Consequently, since decomposing the system into verifiable parts relies on establishing requirements for those parts, then safety requirements are necessary.
- (4) The architecture may not have requirements. During development, the need to argue satisfaction of safety criteria, which cannot be performed at the system level for any practical system, drives the architecture because verifiability depends on the decomposition of the system into verifiable parts.
- (c) Satisfaction of safety criteria
- (1) The concept laid down in [AMC2 ATS.OR.205\(a\)\(2\)](#) is that, provided each element meets its safety requirements, the system will meet its safety criteria. This will be true provided (2) and (3) below are met.
 - (2) The activity needed to meet this objective consists of obtaining sufficient confidence that the set of safety requirements is complete and correct, i.e. that:
 - (i) the architectural decomposition of the elements leads to a complete and correct set of safety requirements being allocated to each sub-element;
 - (ii) each safety requirement is a correct, complete and unambiguous statement of the desired behaviour and does not contradict another requirement or any other subset of requirements; and
 - (iii) the safety requirements allocated to an element necessitate the complete required safety behaviour of the element in the target environment.
 - (3) This should take into account specific aspects such as:
 - (i) the possible presence of functions within the element that produce unnecessary behaviour. For instance, in the case where a previously developed element is used, activities should be undertaken to identify all the possible behaviours of the element. If any of these behaviours is not needed for the foreseen use, then additional requirements may be needed to make sure that these functions will not be solicited or inadvertently activated in operation or that the effects of any resulting behaviour are mitigated;
- (d) other requirements that are not directly related to the desired behaviour of the functional system. These requirements often relate to technical aspects of the system or its components. Activities should ensure that each of these requirements does not compromise the safety of the system, i.e. does not contradict the safety requirements or criteria.

(e) Traceability of requirements

The traceability requirement can be met by tracing to the highest-level element in the architectural hierarchy that has been shown to satisfy its requirements, by verifying it in isolation.

(f) Satisfaction of safety requirements

- (1) The component view taken must be able to support verification, i.e. the component must be verifiable.
- (2) Care should be taken in selecting subsystems that are to be treated as components for verification to ensure that they are small and simple enough to be verifiable.

(g) Adverse effects on safety

- (1) Interactions of all changed components or components affected by the change, operating in their defined context, have to be identified and assessed for safety in order to be able to show that they do not adversely affect safety. This assessment must include the failure conditions for all components and the behaviour of the services delivered to the component including failures in those services.
- (2) Interactions between changing components, as they are installed during transitions into operation, and the context in which they operate have to be identified and assessed for safety in order to be able to show that they do not adversely affect safety. This assessment must include the failure conditions for all installation activities.

In some cases, installing components during transition into operation may cause disruption to services other than the one being changed. These services fall within the scope of the change (see [GM1 ATM/ANS.OR.A.045\(c\); \(d\)](#)), and consequently the safety effects failures of these services, due to failures of the installation activities, have to be assessed as well and, if necessary, their impacts mitigated.

- (3) Interactions in complex systems are dealt with in [ATM/ANS.OR.A.045\(e\)\(1\)](#).

(h) Configuration identification

- (1) [AMC2 ATS.OR.205\(a\)\(2\)](#), point (f) is only about configuration of the evidence and should not be interpreted as configuration management of the changed functional system. However, since the safety case is based on a set of elements and the way they are joined together, the safety case will only be valid if the configuration remains as described in the safety case.
- (2) Evidence for the use of a component should rely on testing activities considering the actual usage domains and contexts. When the same component is used in different parts of the system or in different systems, it may not be possible to rely on testing in a single context since it is unlikely that the contexts for each use will be the same or can be covered by a single set of test conditions. This applies equally to the reuse of evidence gathered from testing subsystems.

AMC3 ATS.OR.205(a)(2) Safety assessment and assurance of changes to the functional system

ED Decision 2019/022/R

ASSURANCE — SOFTWARE

- (a) When a change to a functional system includes the introduction of new software or modifications to existing software, the ATS provider should ensure the existence of documented software assurance processes necessary to produce evidence and arguments that demonstrate that the software behaves as intended (software requirements), with a level of confidence consistent with the criticality of the required application.
- (b) The ATS provider should use the software experience gained to confirm that the software assurance processes are effective and, when used, the allocated software assurance levels (SWALs) and the rigour of the assurances are appropriate. For that purpose, the effects from a software malfunction (i.e. the inability of a programme to perform a required function correctly) or failure (i.e. the inability of a programme to perform a required function) reported according to the relevant requirements on reporting and assessment of service occurrences should be assessed in comparison with the effects identified for the system concerned as per the severity classification scheme.

AMC4 ATS.OR.205(a)(2) Safety assessment and assurance of changes to the functional system

ED Decision 2019/022/R

ASSURANCE — SOFTWARE ASSURANCE PROCESSES

- (a) The software assurance processes should provide evidence and arguments that they, as a minimum, demonstrate the following:
 - (1) The software requirements correctly state what is required by the software, in order to meet the upper level requirements, including the allocated system safety requirements as identified by the safety assessment of changes to the functional system ([AMC2 ATS.OR.205\(a\)\(2\)](#)). For that purpose, the software requirements should:
 - (i) be correct, complete and compliant with the upper level requirements; and
 - (ii) specify the functional behaviour, in nominal and downgraded modes, timing performances, capacity, accuracy, resource usage on the target hardware, robustness to abnormal operating conditions and overload tolerance, as appropriate, of the software.
 - (2) The traceability is addressed in respect of all software requirements as follows:
 - (i) Each software requirement should be traced to the same level of design at which its satisfaction is demonstrated.
 - (ii) Each software requirement allocated to a component should either be traced to an upper level requirement or its need should be justified and assessed that it does not affect the satisfaction of the safety requirements allocated to the component.

-
- (3) The software implementation does not contain functions that adversely affect safety.
 - (4) The functional behaviour, timing performances, capacity, accuracy, resource usage on the target hardware, robustness to abnormal operating conditions and overload tolerance, of the implemented software comply with the software requirements.
 - (5) The software verification is correct and complete, and is performed by analysis and/or testing and/or equivalent means, as agreed with the competent authority.
- (b) The evidence and arguments produced by the software assurance processes should be derived from:
- (1) a known executable version of the software;
 - (2) a known range of configuration data; and
 - (3) a known set of software items and descriptions, including specifications, that have been used in the production of that version, or can be justified as applicable to that version.
- (c) The software assurance processes should determine the rigour to which the evidence and arguments are produced.
- (d) The software assurance processes should include the necessary activities to ensure that the software life cycle data can be shown to be under configuration control throughout the software life cycle, including the possible evolutions due to changes or problems' corrections. They should include, as a minimum:
- (1) configuration identification, traceability and status accounting activities, including archiving procedures;
 - (2) problem reporting, tracking and corrective actions management; and
 - (3) retrieval and release procedures.
- (e) The software assurance processes should also cover the particularities of specific types of software such as COTS, non-development software and previously developed software where generic assurance processes cannot be applied. The software assurance processes should include other means to give sufficient confidence that the software meets the safety objectives and requirements, as identified by the safety risk assessment and mitigation processes. If sufficient assurance cannot be provided, complementary mitigation means aiming at decreasing the impact of specific failure modes of this type of software, should be applied. This may include but is not limited to:
- (1) software and/or system architectural considerations;
 - (2) existing service level experience; and
 - (3) monitoring.

GM1 to AMC4 ATS.OR.205(a)(2) Safety assessment and assurance of changes to the functional system

ED Decision 2019/022/R

ASSURANCE — SOFTWARE ASSURANCE PROCESS

In reference to the terms ‘correct and complete software verification’, ‘software timing performances’, ‘software capacity’, ‘software accuracy’, ‘software resource usage’, ‘software robustness’, ‘overload tolerance’, ‘software life cycle data’ and ‘COTS’, please refer to [GM1 to AMC6 ATM/ANS.OR.C.005\(a\)\(2\)](#) ‘Safety support assessment and assurance of changes to the functional system’.

GM2 to AMC4 ATS.OR.205(a)(2) Safety assessment and assurance of changes to the functional system

ED Decision 2019/022/R

ASSURANCE — SOFTWARE ASSURANCE LEVELS

- (a) The assurance required by [AMC4 ATS.OR.205\(a\)\(2\)](#) can be provided with a level of confidence consistent with the criticality of the software in order to generate an appropriate and sufficient body of evidence to help to establish the required confidence in the argument.
- (b) The use of the SWAL concept can be helpful to provide an explicit link between the criticality of the software and the rigour of the assurance.
- (c) The use of multiple SWALs would also allow the possibility of managing several criticalities of the different software components within the system (with partitioning or other architectural strategies) by the same set of software assurance processes. When the software assurance processes employ on several SWALs, they should define for each SWAL the rigour of the assurances to achieve compliance with the objectives set out in [AMC4 ATS.OR.205\(a\)\(2\)](#). As a minimum:
 - (1) the rigour should increase as the criticality of the service supported by the software solution increases; and
 - (2) the variation in rigour of the evidence and arguments per SWAL should include a classification of the activities and objectives according to the following criteria:
 - (i) required to be achieved with independence, i.e. the verification process activities are performed by a person (or persons) other than the developer of the item being verified;
 - (ii) required to be achieved; and
 - (iii) not required.

GM3 to AMC4 ATS.OR.205(a)(2) Safety assessment and assurance of changes to the functional system

ED Decision 2019/022/R

ASSURANCE — SOFTWARE ASSURANCE LEVELS ALLOCATION

The process to allocate a SWAL to a software consistently with its foreseen criticality, as identified by the risk assessment and mitigation process, should consider the following elements:

- (a) The allocated SWAL should relate the rigour of the software assurances to the foreseen criticality of the software by using the combination of the used severity classification scheme with the likelihood of occurrence of a certain adverse effect.
- (b) The allocated SWAL should be commensurate with the worst credible effect that software malfunctions (i.e. the inability of a programme to perform a required function correctly) or failures (i.e. the inability of a programme to perform a required function) may cause. It should, in particular, take into account the risks associated with software malfunctions or failures and the architecture and/or procedural defences.
- (c) The software components that cannot be shown to be independent of one another should be allocated to the SWAL of the most critical of the dependent components. In this context, the term ‘software components’ is understood to be a building block that can be fitted or connected together with other reusable blocks of software to combine and create a custom software application, and ‘independent software components’ are those software components which are not rendered inoperative by the same failure condition.
- (d) The allocated SWALs should be consistent with the levels defined in the software assurance processes of the ATS provider and of the non-ATS provider(s), when the safety case is based on the evidence presented in the corresponding safety support case(s).

GM4 to AMC4 ATS.OR.205(a)(2) Safety assessment and assurance of changes to the functional system

ED Decision 2019/022/R

ASSURANCE — EXAMPLES OF EXISTING INDUSTRIAL STANDARDS

- (a) The service provider is responsible for the definition of the software assurance processes. In this definition of processes, the service provider may consider the guidance material contained in existing industrial standards for the software assurance considerations of software. It should be considered that not all standards address all aspects required and the service provider may need to define additional software assurance processes. The guidance material typically includes:
 - (1) objectives of the software life cycle processes;
 - (2) activities for satisfaction of those objectives;
 - (3) descriptions of the evidence, in the form of software life cycle data, that indicates that the objectives have been satisfied;
 - (4) variations according to the SWAL, to accommodate the different levels of rigour of the software assurances; and

- (5) particular aspects (e.g. previously developed software) that may be applicable to certain applications.
- (b) The following table presents some of the existing industrial standards (at the latest available issue) used by the stakeholders:

Document title	Reference	Date
Software Integrity Assurance Considerations for Communication, Navigation, Surveillance and Air Traffic Management (CNS/ATM) Systems.	EUROCAE ED-109A/ RTCA DO-278A	January 2012
Guidelines for ANS Software Safety Assurance	EUROCAE ED-153	August 2009
Functional safety of electrical/electronic/programmable electronic safety-related systems – Part 3: Software requirements	IEC 61508 – Part 3	April 2010
Software Considerations in Airborne Systems and Equipment Certification	EUROCAE ED-12C/ RTCA DO-178C	January 2012

EUROCAE ED-109A/RTCA DO-278A and EUROCAE ED-12C/RTCA DO-178C make reference to some external documents (supplements), which are integral part of the standard for the use of some particular technologies and development techniques. The supplements are the following:

- (1) Formal Methods Supplement to ED-12C and ED-109A (EUROCAE ED-216/RTCA DO-333)
- (2) Object-Oriented Technology and related Techniques Supplement to ED-12C and ED-109A (EUROCAE ED-217/RTCA DO-332)
- (3) Model-Based Development and Verification Supplement to ED-12C and ED-109A (EUROCAE ED-218/RTCA DO-331)

When tools are used during the software development lifecycle, EUROCAE ED-215/RTCA DO-330 ‘Software Tool Qualification Considerations’ may be considered in addition to EUROCAE ED-12C/RTCA DO-178C and EUROCAE ED-109A/RTCA DO-278A.

- (c) The definition of the software assurance processes may be based on one of these industrial standards, without combining provisions from different standards as far as the consistency and validation of each of the industrial standards have only been performed at individual level by each specific standardisation group.

GM5 to AMC4 ATS.OR.205(a)(2) Safety assessment and assurance of changes to the functional system

ED Decision 2019/022/R

ASSURANCE — SWAL COORDINATION

- (a) Within the scope of this Regulation, only the ATS provider can identify hazards, assess the associated risks and mitigate or propose mitigating measures where necessary. This requirement is also applicable to software assurance evidence which may include information on the mitigation measures established to address software failures or unintended behaviours.
- (b) ATS and non-ATS providers may rely on different sets of software assurance processes and, if applicable, different sets of SWALs.
- (c) For a particular change to the functional system, the safety assessment performed by the ATS provider, and documented in the safety case, may rely on evidence associated with the services

provided by a non-ATS provider, as documented in its corresponding safety support case. It should as a minimum demonstrate that the rigour of the assurances produced by the non-ATS provider within the safety support case provides the adequate level of confidence for the purpose of the ATS safety demonstration in the safety case.

- (d) If SWALs are used, the ATS provider should evaluate the adequacy of the SWALs defined in the software assurance processes of the non-ATS providers and the consistency of the allocated SWALs for the parts of the functional system affected by the change at the non-ATS provider.

GM1 ATS.OR.205(a)(2) Safety assessment and assurance of changes to the functional system

ED Decision 2017/001/R

SAFETY CRITERIA

‘Safety criteria will remain satisfied’ means that the safety criteria continue to be satisfied after the change is implemented and put into operation. The safety case needs to provide assurance that the monitoring requirements of [ATS.OR.205\(b\)\(6\)](#) are suitable for demonstrating, during operation, that the safety criteria remain satisfied and, therefore, the argument remains valid.

GM2 ATS.OR.205(a)(2) Safety assessment and assurance of changes to the functional system

ED Decision 2017/001/R

ASSURANCE LEVELS

The use of assurance level concepts, e.g. design assurance levels (DAL), software assurance levels (SWAL), hardware assurance levels (HWAL), can be helpful in generating an appropriate and sufficient body of evidence to help establish the required confidence in the argument.

GM3 ATS.OR.205(a)(2) Safety assessment and assurance of changes to the functional system

ED Decision 2017/001/R

SAFETY REQUIREMENTS

The following non-exhaustive list contains examples of safety requirements that specify:

- (a) for equipment, the complete behaviour, in terms of functions, accuracy, timing, order, format, capacity, resource usage, robustness to abnormal conditions, overload tolerance, availability, reliability, confidence and integrity;

The complete behaviour is limited to the scope of the change. Safety requirements should only apply to the parts of a system affected by the change. In other words, if parts of a system can be isolated from each other and only some parts are affected by the change, then these are the only parts that are of concern;

- (b) for people, their performance in terms of tasks (e.g. accuracy, response times, acceptable workload, reliability, confidence, skills, and knowledge in relation to their tasks);

- (c) for procedures, the circumstances for their enactment, the resources needed to perform the procedure (i.e. people and equipment), the sequence of actions to be performed and the timing and accuracy of the actions; and
- (d) interactions between all parts of the system.

GM1 ATS.OR.205(b) Safety assessment and assurance of changes to the functional system

ED Decision 2017/001/R

SAFETY ASSESSMENT METHODS

- (a) The air traffic services provider can use a standard safety assessment method or it can use its own safety assessment method to assist with structuring the process. However, the application of a method is not a guarantee of the quality of the results. It is therefore not sufficient for a safety case to claim that the assurance provided is adequate due to compliance with a standard or method.
- (b) There are databases available that describe different safety assessment methods, tools and techniques¹ that can be used by the air traffic services provider. The provider must ensure that the safety assessment method is adequate for the change being assessed and that the assumptions inherent in the use of the method are recognised and accommodated appropriately.

AMC1 ATS.OR.205(b)(1) Safety assessment and assurance of changes to the functional system

ED Decision 2017/001/R

COMPLETENESS OF HAZARD IDENTIFICATION

The air traffic services provider should ensure that hazard identification:

- (a) targets complete coverage of any condition, event, or circumstance related to the change, which could, individually or in combination, induce a harmful effect;
- (b) has been performed by personnel trained and competent for this task; and
- (c) need only include hazards that are generally considered as credible.

AMC2 ATS.OR.205(b)(1) Safety assessment and assurance of changes to the functional system

ED Decision 2017/001/R

HAZARDS TO BE IDENTIFIED

The following hazards should be identified:

- (a) New hazards, i.e. those introduced by the change relating to the:
 - (1) failure of the functional system; and

¹ For example, <http://www.nlr.nl/downloads/safety-methods-database.pdf> or <http://www.scsc.org.uk/>

- (2) normal operation of the functional system; and
- (b) Already existing hazards that are affected by the change and are related to:
 - (1) the existing parts of the functional systems; and
 - (2) hazards outside the functional system, for example, those inherent to aviation.

GM1 ATS.OR.205(b)(1) Safety assessment and assurance of changes to the functional system

ED Decision 2017/001/R

HAZARD IDENTIFICATION

- (a) Completeness of hazard identification

In order to achieve completeness in the identification of hazards, it might be beneficial to aggregate hazards and to formulate them in a more abstract way, e.g. at the service level. This might in turn have drawbacks when analysing and evaluating the risk of the hazards. The appropriate level of detail in the set of hazards and their formulation, therefore, depends on the change and the way the safety assessment is executed.

Only credible hazards need to be identified. A credible hazard is one that has a material effect on the risk assessment. A hazard will not be considered credible when it is either highly improbable that the hazard will occur or that the accident trajectories it initiates will materialise. In other words, a hazard need not be considered if it can be shown that it induces an insignificant risk.

- (b) Sources of hazards

- (1) Hazards introduced by failures or nominal operations of the ATM/ANS functional systems may include the following factors and processes:
 - (i) design factors, including equipment, procedural and task design;
 - (ii) operating practices, including the application of procedures under actual operating conditions and the unwritten ways of operating;
 - (iii) communications, including means, terminology, order, timing and language and including human–human, human–machine and machine–machine communications;
 - (iv) installation issues;
 - (v) equipment and infrastructure, including failures, outages, error tolerances, nuisance alerts, defect defence systems and delays; and
 - (vi) human performance, including restrictions due to fatigue and medical conditions, and physical limitations, when considered relevant to the change assessment.
- (2) Hazards introduced in the context in which the ATM/ANS functional system operates may include the following factors and processes:
 - (i) wrong, insufficient or delayed information and inadequate services delivered by third parties;

- (ii) personnel factors, including working conditions, company policies for and actual practice of recruitment, training and allocation of resources, when considered relevant to the change;
 - (iii) organisational factors, including the incompatibility of production and safety goals, the allocation of resources, operating pressures and the safety culture;
 - (iv) work environment factors such as ambient noise, temperature, lighting, annoyance, ergonomics and the quality of man–machine interfaces; and
 - (v) external threats such as fire, electromagnetic interference and sources of distraction, when considered relevant to the change.
- (3) The hazards introduced in the context in which the ATM/ANS services are delivered may include the following factors and processes:
- (i) errors, failures, non-compliance and misunderstandings between the airborne and ground domains;
 - (ii) traffic complexity, including traffic growth, fleet mix and different types of traffic, when considered relevant to the change;
 - (iii) wrong, insufficient or delayed information delivered by third parties;
 - (iv) inadequate service provisioning by third parties; and
 - (v) external physical factors, including terrain, weather phenomena, volcanoes and animal behaviour, when considered relevant to the change.
- (c) Methods to identify hazards
- (1) The air traffic services provider may use a combination of tools and techniques, including functional analysis, what if techniques, brainstorming sessions, expert judgement, literature search (including accident and incident reports), queries of accident and incident databases in order to identify hazards.
 - (2) The air traffic services provider needs to make sure that the method is appropriate for the change and produces (either individually or in combination) a valid (necessary and sufficient) set of hazards. This may be aided by drawing up a list of the functions associated with part of the functional system being changed. The air traffic services provider needs to make sure their personnel that use these techniques are appropriately trained to apply these methods and techniques.

AMC1 ATS.OR.205(b)(2) Safety assessment and assurance of changes to the functional system

ED Decision 2017/001/R

DETERMINATION OF THE SAFETY CRITERIA FOR THE CHANGE

When determining the safety criteria for the change being assessed, the air traffic services provider should, in accordance with [ATS.OR.210](#), ensure that:

- (a) the safety criteria support a risk analysis that is:
 - (1) relative or absolute, i.e. refers to:
 - (i) the difference in safety risk of the system due to the change (relative); or

- (ii) the difference in safety risk of the system and a similar system (can be absolute or relative); and
 - (iii) the safety risk of the system after the change (absolute); and
- (2) objective, whether risk is expressed numerically or not;
- (b) the safety criteria are measurable to an adequate degree of certainty;
 - (c) the set of safety criteria can be represented totally by safety risks, by other measures that relate to safety risk or a mixture of safety risks and these other measures;
 - (d) the set of safety criteria should cover the change; the safety criteria selected are consistent with the overall safety objectives established by the air traffic services provider through its SMS and represented by its annual and business plan and safety key performance indicators; and
 - (e) where a safety risk or a proxy cannot be compared against its related safety criteria with acceptable certainty, the safety risk should be constrained and actions should be taken, in the long term, so as to manage safety and ensure that the air traffic services provider's overall safety objectives are met.

AMC1 ATS.OR.205(b)(3) Safety assessment and assurance of changes to the functional system

ED Decision 2017/001/R

COMPLETENESS OF RISK ANALYSIS

The air traffic services provider should ensure that the risk analysis is carried out by personnel trained and competent to perform this task and should also ensure that:

- (a) a complete list of harmful effects in relation to the identified:
 - (1) hazards, when the safety criteria are expressed in terms of safety risk, or proxies, when the safety criteria are expressed in relation to proxies; and
 - (2) hazards introduced due to implementationis produced; and
- (b) the risk contributions of all hazards and proxies are evaluated; and
- (c) risk analysis is conducted in terms of risk or in terms of proxies or a combination of them, using specific measurable properties that are related to operational safety risk; and
- (d) results can be compared against the safety criteria.

AMC2 ATS.OR.205(b)(3) Safety assessment and assurance of changes to the functional system

ED Decision 2017/001/R

SEVERITY CLASSIFICATION OF ACCIDENTS LEADING TO HARMFUL EFFECTS

When performing a risk analysis in terms of risk, the air traffic services provider should ensure that the harmful effects of all hazards are allocated a safety severity category and that, where there is more than one safety severity category of harm, any severity classification scheme satisfies the following criteria:

- (a) The scheme is independent of the causes of the accidents that it classifies, i.e. the severity of the worst accident does not depend upon whether it was caused by an equipment malfunction or human error;
- (b) The scheme permits unique assignment of every harmful effect to a severity category;
- (c) The severity categories are expressed in terms of a single scalar quantity and in terms relevant to the field of their application;
- (d) The level of granularity (i.e. the span of the categories) is appropriate to the field of their application;
- (e) The scheme is supported by rules for assigning a harmful effect unambiguously to a severity category; and
- (f) The scheme is consistent with the air traffic services providers views of the severity of the harmful effects covered and can be shown to incorporate societal views of their severity.

AMC1 ATS.OR.205(b)(4) Safety assessment and assurance of changes to the functional system

ED Decision 2017/001/R

RISK EVALUATION

The air traffic services provider should ensure that the risk evaluation includes:

- (a) an assessment of the identified hazards for a notified change, including possible mitigation means, in terms of risk or in terms of proxies or a combination of them;
- (b) a comparison of the risk analysis results against the safety criteria taking the uncertainty of the risk assessment into account; and
- (c) the identification of the need for risk mitigation or reduction in uncertainty or both.

GM1 to AMC1 ATS.OR.205(b)(4) Safety assessment and assurance of changes to the functional system

ED Decision 2017/001/R

RISK ANALYSIS IN TERMS OF PROXIES — EXAMPLES

Point (c) of [AMC1 ATS.OR.205\(b\)\(2\)](#) allows safety assessment to be performed in terms of risk, proxies or a combination of risk and proxies. This GM provides two examples to illustrate the use of proxies in safety analysis.

- (a) Use of proxies when assessing the safety of a wind farm installation
 - (1) A wind farm is to be introduced on or near an aerodrome. It is assumed that before the introduction of the wind farm, the safety risk of the air traffic services being provided at the aerodrome was acceptable. To return to this level after the introduction of the farm, the change would also be acceptable.

A diagram showing the effects this has on the risk at the aerodrome is shown below:

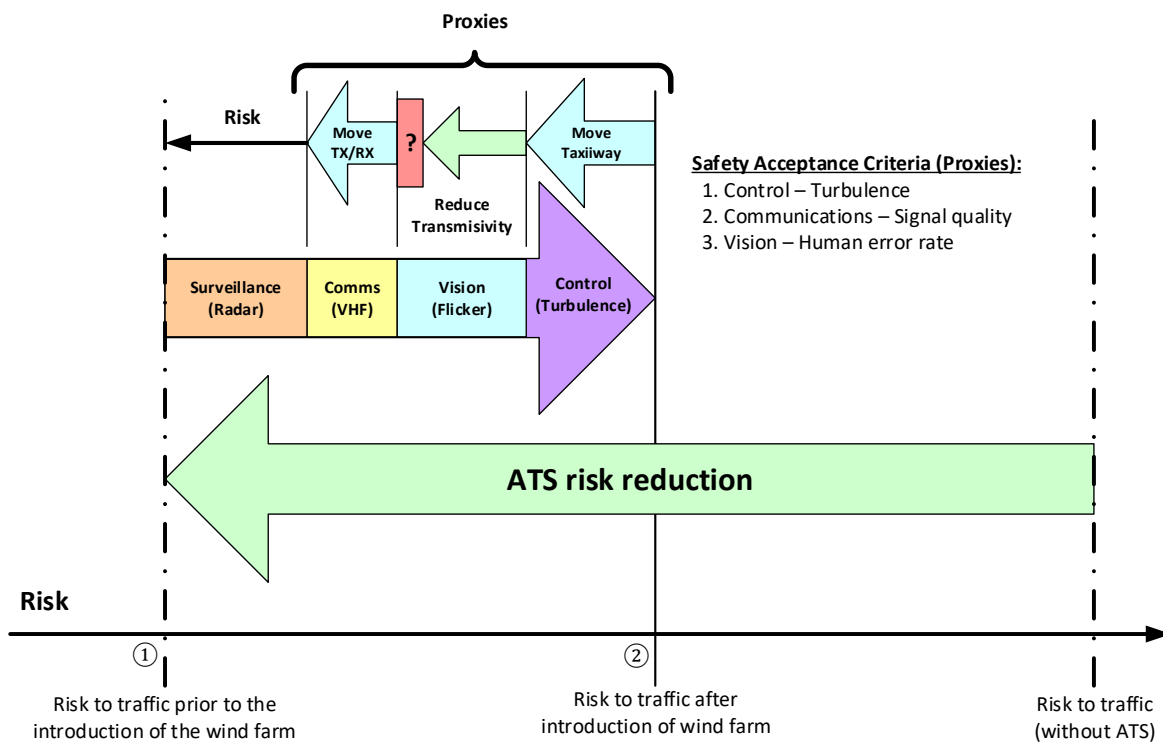

Figure 1: Evaluation of risks after the introduction of wind farm

- (2) The risk due to the introduction of the wind farm will rise from ① to ②, if not mitigated, because:
- (i) turbulence will increase and so may destabilise manoeuvring of aircraft;
 - (ii) the movement of the blades will cause radio interference (communications radio and surveillance radar) and so communications may be lost or aircraft may be hidden from view on the radar screen; and
 - (iii) the flicker in the peripheral vision of ATCOs, caused by the rotation of the blades, may capture attention and increase their perception error rate.
- (3) The problem of analysing the safety impact can be split into these areas of concern since they do not interact or overlap and so satisfy the independence criterion (b) of [AMC2 ATS.OR.210\(a\)](#). However, whilst it can be argued that each is a circumstantial hazard and that in each case a justifiable qualitative relationship can be established linking the hazard with the resulting accident (so satisfying the causality criterion (a) of [AMC2 ATS.OR.210\(a\)](#)), the actual or quantitative logical relationship is, in each case, extremely difficult to determine. Conditions for seeking proxies have, therefore, been established:
- Performing a risk evaluation using actual risk may not be worthwhile due to the considerable cost and effort involved; and
 - The first two criteria for proxies have been satisfied.

Consequently, it may be possible to find proxies that can be used more simply and effectively than performing an analysis based on risk.

- (4) The solutions proposed below are for illustrative purposes only. There are many other solutions and, for each change, several should be investigated. In this example, the following proxies, which satisfy the measurability criterion (c) of [AMC2 ATS.OR.210\(a\)](#), are used to set safety criteria:
- (i) Turbulence can be measured and predicted by models so the level of turbulence can be a proxy.
- In this example, let's assume the only significant effect of turbulence is to light aircraft using a particular taxiway. It is possible to predict the level of turbulence at different sites on the aerodrome and an alternative taxiway is found where the level of turbulence after the introduction of the wind farm will be less than that currently encountered on the present taxiway. This can be confirmed during operation after the change by monitoring.
- (ii) Signal quality can be also be predicted by models and measured so it can be used as a proxy.
- In this example, it is possible to move the communications transmitter and receiver aerials so that communications are not affected by interference. Sites can be found using modelling and the signal quality confirmed prior to moving the aerials by trial installations during periods when the aerodrome is not operating.
- (iii) Human error rate in detecting events on the manoeuvring area can be measured in simulations and can be used as a proxy.
- It is suggested that increasing the opaqueness of the glass in the control tower will reduce the effects of flicker on the ATCOs, but there is no direct relationship between the transmissivity and the effects of flicker. It is, therefore, decided to make a simulation of the control tower and measure the effects of flicker on human error rate using glass of different levels of transmissivity.
- However, there is a conflict between increasing the opaqueness of the glass to reduce the effects of flicker and decreasing it to improve direct vision, which is needed so that manoeuvring aircraft can be seen clearly. In other words, the simulation predicts a minimum for the human error rate that relates to a decrease, as the effects of flicker decrease, followed by an increase, as the effects of a lack of direct vision increase. This minimum is greater than the human error rate achieved by the current system and so the risk of the wind farm, in respect of flicker, cannot be completely mitigated. This is shown by the red box with a question mark in it on the diagram.
- (5) Finally, the argument for the performance of surveillance radars is commonly performed using risk. This can be repeated in this case since the idea is to filter the effects of the interference without increasing the risk. Moreover, if necessary, a system may be added (or a current one improved) to reduce the risk simply and economically and the effects of the additional system may be argued using risk.
- (6) Since risks can be combined, the safety impacts of the changes to the surveillance radar by filtering the effects of the interference together with the addition of another system or the improvement of the current system can be established by summing the risks associated with these two kinds of change.

- (7) In these circumstances, it is not possible to argue objectively that the risk of introducing the wind farm has been mitigated, as risks cannot be summed with proxies. This demonstrates the difficulties of using proxies. However, it may be possible to argue convincingly, albeit subjectively, that installing another system or improving the current system improves the current level of risk by a margin large enough to provide adequate compensation for the unmitigated effects of flicker.
- (8) In summary, this example shows how proxies and risks can be combined in a single assurance case to argue that a change to a functional system can be introduced safely. It also demonstrates that the strategies available to demonstrate safety are not generic, but are dependent on identifying analysable qualities or quantities related to specific properties of the system or service that are impacted by the change.
- (b) Use of proxies when changing to electronic flight strips
- (1) An air traffic services provider considers the introduction of a digital strip system in one of its air traffic control towers to replace the paper flight progress strips currently in use. This change is expected to have an impact on several aspects of the air traffic control service that is provided such as the controller's recollection of the progress of the flight, the mental modelling of the traffic situation and the communication and task allocation between controllers. A change of the medium, from paper to digital, might, therefore, have implications on the tower operations, and, hence, on the safety of the air traffic. The actual relation between the change of the strip medium and the risk for the traffic is, however, difficult to establish.
- (2) The influence of the quantity on the risk is globally known, but cannot easily be quantified. One difficulty is that strip management is at the heart of the air traffic control operations: the set of potential sequences of events from a strip management error to an accident or incident is enormous. This set includes, for example, the loss of the call sign at the moment a ground controller needs to intervene in a taxiway conflict, and whether this results in an incident depends, for example, on the visibility. This set also includes the allocation of a wrong standard instrument departure (SID) to an aircraft, and whether this results in an accident depends, for example, on the runway configuration.

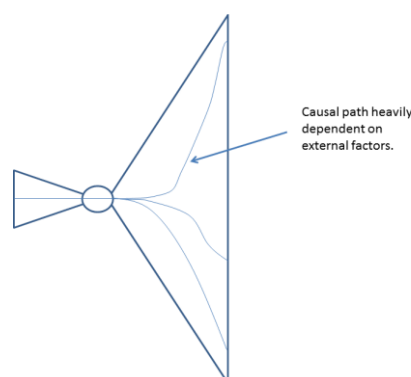

Figure 2: Notional Bow Tie Model of a strip management error

- (3) The Bow Tie Model of a strip management error has, figuratively speaking, a vertically stretched right part. This expresses that a hazard — such as the loss of a single strip — may have many different outcomes which heavily depend on factors that have nothing to do with the cause of the hazard — factors such as the status of the aircraft

corresponding to the absent strip, that aircraft’s position on the aerodrome, the traffic situation and the visibility.

- (4) Another difficulty with the relationship between the change of the medium and the risk to the air traffic is that several human and cultural aspects are involved. The difficulty lies in the largely unknown causal relationship between these human and cultural aspects and the occurrences of accidents and incidents. As an example of this, it is noted that strip manipulation — like moving a strip into another bay, or making a mark to indicate that a landing clearance is given — assists a controller in distinguishing the potential from the actual developments. The way of working with paper strips generates impressions in a wider variety than digital strips by their physical nature: handling paper strips has tactile, auditory and social aspects. This difference in these aspects may lead to a difference in the quality of the controller’s situation awareness which may lead to a difference in the efficacy of the controller’s instructions and advisories, which may lead to a difference in the occurrence of accidents and incidents. However, the relation between the change of the medium and the risk for the air traffic is difficult to assess and would require a great deal of effort, time and experimentation to quantify.

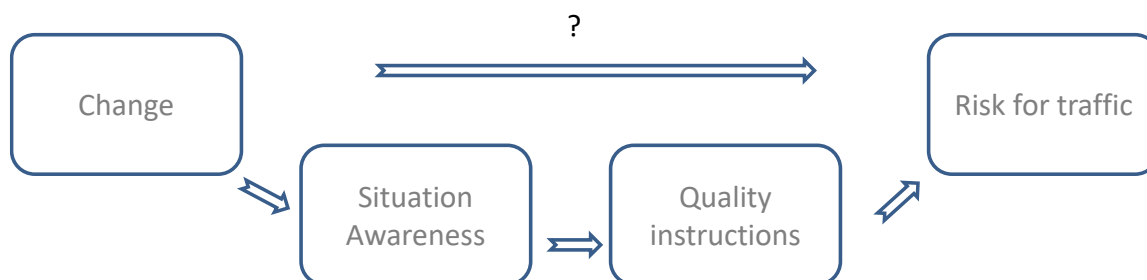

Figure 3: Relation between the change of flight strip and the risk

- (5) There is probably a relation between the change of the flight progress strip medium and the risk for air traffic: a new human–machine interface may have an effect on the situation awareness of some individual controllers in some circumstances, which might have an effect on whether, when and what instructions are given, and this in turn influences the aircraft movements, and, hence, the risks. The question by what amount risks increase or decrease is very hard to answer.
- (6) Performing a risk evaluation using actual risk may not be worthwhile due to the difficulties and considerable cost and effort involved in assessing the risk of the change directly. Therefore, the use of proxies might be preferred. A quantity is only considered an appropriate proxy if it satisfies the criteria in point [AMC2 ATS.OR.210\(a\)](#):
- (i) **Causality:** The quantity used as proxy can be expected to be influenced by the change, and the risk can be expected to be influenced by the quantity. In addition to this causal relationship, a criterion can be formulated and agreed upon that expresses by which amount the value of the quantity may shift due to the change. Note that the influence of the proxy on the risk cannot easily be quantified, otherwise it might be more beneficial to use risk as a measure and the quantity as an auxiliary function.
 - (ii) **Measurability:** The influence of the change on the quantity can be assessed before as well as after the change.

- (iii) Independence: When the proxy selected does not cover all hazards, a set of proxies should be used. Any proxy of that set should be sufficiently isolated from other proxies to be treated independently.

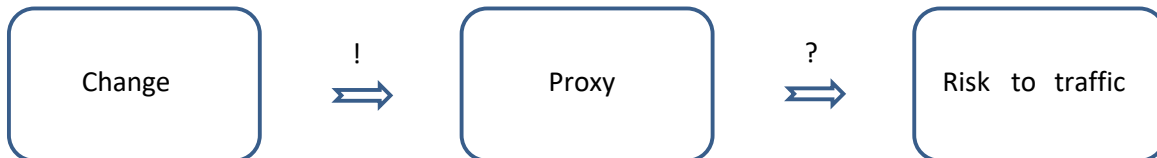

Figure 4: Relation between proxy and risk

- (7) There is a relationship between the change and the proxy, and there is a relationship between the proxy and the risk to traffic. The first relationship can be assessed (indicated by the '!'), while the second cannot (indicated by the '?'). An acceptance criterion is typically formulated for the amount the proxy value might increase or decrease.
- (8) Proxy 1: Head-down time. The head-down time is a good proxy as it satisfies the conditions of:
 - (i) Causality: It is known that more head-down time leads to a higher risk but there is no well-established or generally accepted statement in literature in terms of: 'x % more head-down time implies y% more accidents', not to mention for the specific circumstances of the specific air traffic control tower. The causal relationship indicated in Figure 4 can be established because:
 - (A) the head-down time can be expected to change as the manipulation, writing and reading of digital strips might cost more, or perhaps less, attention and effort than the handling of paper strips;
 - (B) the loss of head-up time of ground and runway controllers implies less surveillance, at least less time for the out-of-the-window-view in good visibility, and this implies a later or less probable detection of conflicts; and
 - (C) an example of an acceptance criterion reads: 'The introduction of the digital strip system does not lead to a significant increase in the head down time'.
 - (ii) Measurability: The influence of the change on the head-down time can be assessed before the change by means of real-time human-in-the-loop experiments in which controllers are tasked to handle equal amounts of traffic in equal circumstances, one time using paper strips and another time using digital strips. The percentage of head-down time can then be determined by observing the controllers by cameras and eye-trackers.
- (9) Proxy 2: Fraction of erroneous SID allocations. The fraction of erroneous SID allocations is a good proxy as it satisfies the conditions of:
 - (i) Causality: It can be imagined that an erroneous SID selected in the flight management system (FMS) might lead to accidents, but the precise conditional probability is small and difficult to estimate as it depends on several external factors such as the flight paths of the correct and incorrect SIDs, the presence of other traffic, the timing and geometry of the trajectories, the cloud base or the vigilance of the controller. The causal relationship indicated in Figure 4 can be established because:

- (A) the number of incorrect SIDs indicated on electronic strips can be expected to be less than on paper strips, because of the possibilities of systematic checks with respect to runway allocation, runway configuration, SID allocation of the predecessor and destination in the flight plan;
 - (B) the allocation of an incorrect SID to an aircrew might lead to a situation in which the aircraft manoeuvres in an unanticipated way, possibly leading to a conflict with another aircraft, for example departing from a parallel runway; and
 - (C) an example of an acceptance criterion reads: ‘The introduction of the digital strip system should lead to a decrease of the fraction of erroneous SID allocations of more than 20 %’.
- (ii) Measurability: The influence of the change on the fraction of erroneous SID allocations can be assessed before the change by means of an analysis of the causes and occurrences of such errors and the estimated efficacy of the systematic checks. The fractions can be assessed after the change by the statistics of the event reports.
- (10) Finally, the last condition of independence of proxies is also satisfied. For the purpose of this example, the proxies in (5) and (6) form a set of independent proxies that are complete, i.e. they cover all identified hazards introduced by the replacement of paper strips by a digital strip system.

AMC2 ATS.OR.205(b)(4) Safety assessment and assurance of changes to the functional system

ED Decision 2020/008/R

RISK MITIGATION

When the risk evaluation results show that the safety criteria cannot be satisfied, then the air traffic services provider should either abandon the change or propose additional means of mitigating the risk. If risk mitigation is proposed, then the air traffic services provider should ensure that it identifies:

- (a) all of the elements of the functional system, e.g. training, procedures that need to be reconsidered; and
- (b) for each part of the amended change, those parts of the safety assessment (requirements from (1) to (6) listed in [ATS.OR.205\(b\)](#)) that need to be repeated in order to demonstrate that the safety criteria will be satisfied.

GM1 ATS.OR.205(b)(4) Safety assessment and assurance of changes to the functional system

ED Decision 2017/001/R

RISK ANALYSIS IN TERMS OF SAFETY RISK

- (a) Risk analysis

When a risk assessment of a set of hazards is executed, in terms of risk:

- (1) the frequency or probability of the occurrence of the hazard should be determined;

- (2) the possible sequences of events from the occurrence of a hazardous event to the occurrence of an accident, which may be referred to as accident trajectories, should be identified. The contributing factors and circumstances that distinguish the different trajectories from one another should also be identified, as should any mitigations between a hazardous event and the associated accident;
- (3) the potential harmful effects of the accident, including those resulting from a simultaneous occurrence of a combination of hazards, should be identified;
- (4) the severity of these harmful effects should be assessed, using a defined severity scheme according to point (f) of [AMC2 ATS.OR.205\(b\)\(3\)](#); and
- (5) the risk of the potential harmful effects of all the accidents, given the occurrence of the hazard, should be determined, taking into account the probabilities that the mitigations may fail as well as succeed, and that particular accident trajectories will be followed when particular contributing factors and circumstances occur.

(b) Severity schemes

The severity determination should take place according to a severity classification scheme.

The purpose of a severity classification scheme is to facilitate the management and control of risk. A severity class is, in effect, a container within which accidents can be placed if their severities are considered similar. Each container can be given a value which represents the consequences, i.e. small for accidents causing little harm and big for accidents causing a lot of harm. The sum of the probabilities of all the accidents assigned to a severity class multiplied by the value that is related to the severity class, is the risk associated with that class. If the value that represents severity for all classes is scalar, then the total risk is the sum of the risks in each severity class.

(1) Single-risk value severity schemes

Such schemes use a single severity category to represent harm to humans. Other categories representing other kinds of harm e.g. damage to aircraft and loss of separation, may be present but do not represent harm to humans. In these circumstances, risk analysis would actually be reduced to frequency/probability analysis.

(2) Multiple-risk value severity schemes

Multiple-risk value severity schemes, which use a number of severity categories to classify different levels of harm, facilitate the management and control of risk in a number of ways. At the simplest level, the distribution of accidents across the severity classes gives a picture of whether the risk profile of a system is well balanced. For example, many accidents in the top and bottom severity classes with few in between suggests an imbalance in risk, perhaps due to an undue amount of attention having been paid to some types of accident at the expense of others. More detailed management and control of risk includes:

- (i) Severity classes may be used as the basis for reporting accident statistics.
- (ii) Severity classes combined with frequency (or probability) classes can be used to define criteria for decision-making regarding risk acceptance.

- (iii) The total risk associated with one or more severity classes can be managed and controlled. For example, the sum of the risk from all severity classes represents the total risk and may be used as a basis for making decisions about changes.
 - (iv) Similarly, the risk associated with accident types of different levels of severity can be compared. For example, comparing runway infringement accidents with low speed taxiway accidents would allow an organisation to focus their efforts on mitigating the accident type with greatest risk.
- (c) The air traffic services provider should coordinate its severity scheme(s) when performing multi-actor changes to ensure adequate assessment. This includes coordination with air traffic services providers outside of the EU.

AMC1 ATS.OR.205(b)(5) Safety assessment and assurance of changes to the functional system

ED Decision 2017/001/R

VERIFICATION

The air traffic services provider should ensure that verification activities of the safety assessment process include verification that:

- (a) the full scope of the change is addressed throughout the whole assessment process, i.e. all the elements of the functional system or environment of operation that are changed and those unchanged elements that depend upon them and on which they depend are identified;
- (b) the way the service behaves complies with and does not contradict any applicable requirements placed on the changed service or the conditions attached to the providers certificate;
- (c) the specification of the way the service behaves is complete and correct;
- (d) the specification of the operational context is complete and correct;
- (e) the risk analysis is complete as per [AMC1 ATS.OR.205\(b\)\(3\)](#);
- (f) the safety requirements are correct and commensurate with the risk analysis;
- (g) the design is complete and correct with reference to the specification and correctly addresses the safety requirements;
- (h) the design was the one analysed; and
- (i) the implementation, to the intended degree of confidence, corresponds to that design and behaves only as specified in the given operational context.

GM1 ATS.OR.205(b)(5) Safety assessment and assurance of changes to the functional system

ED Decision 2017/001/R

OUTCOME OF RISK EVALUATION

The purpose of risk evaluation is to evaluate the risk of the change and to compare that against the safety criteria with the following outcomes in mind:

- (a) A possible (desired) outcome is that the assessed risk satisfies the safety criteria. This implies that the change is assessed as sufficiently safe to implement.

- (b) Another possible outcome is that the assessed risk does not satisfy the safety criteria. This might lead to the decision to refine the risk analysis, to the decision to add mitigating means, or to the decision to abandon the change.

GM2 ATS.OR.205(b)(5) Safety assessment and assurance of changes to the functional system

ED Decision 2017/001/R

RISK EVALUATION — UNCERTAINTY

- (a) The outcome of a risk analysis is uncertain due to modelling, estimates, exclusion of rare circumstances or contributing factors, incident and safety event underreporting, false or unclear evidence, different expert opinions, etc. The uncertainty may be indicated explicitly, e.g. by means of an uncertainty interval, or implicitly, e.g. by means of a reference to the sources the estimates are based upon.
- (b) Where possible sequences of events, contributing factors and circumstances are excluded in order to simplify the risk estimate, which may be necessary to make the estimate of risks feasible, arguments and evidence justifying this should be provided in the safety case. This may result in increasing the uncertainty of the risk estimations.

GM3 ATS.OR.205(b)(5) Safety assessment and assurance of changes to the functional system

ED Decision 2017/001/R

RISK EVALUATION — FORMS OF RISK EVALUATION

The risk evaluation can take several forms, even within the safety assessment of a single change, depending on the nature of the risk analysis and the safety criteria:

- (a) If a set of safety requirements has been created and can be unambiguously and directly related to the safety criteria, then the risk evaluation takes the form of justifying that these requirements satisfy the safety criteria;
- (b) If the safety criteria have been established in terms of the likelihood of the hazards and the severity of their effects, then the risk evaluation takes the form of verifying that the assessed risks satisfy the safety criteria in terms of risks; and
- (c) If the values of all relevant proxies have been determined, then the risk evaluation takes the form of verifying that these values satisfy the safety criteria in terms of proxies.

GM4 ATS.OR.205(b)(5) Safety assessment and assurance of changes to the functional system

ED Decision 2017/001/R

TYPE OF RISK MITIGATION

Risk mitigation may be achieved in the following ways:

- (a) an improvement of the performance of a functional subsystem;
- (b) an additional change of the ATM/ANS functional system;

- (c) an improvement of the services delivered by third parties;
- (d) a change in the physical environment; or
- (e) any combination of the above-mentioned methods.

GM1 ATS.OR.205(b)(5)(ii) Safety assessment and assurance of changes to the functional system

ED Decision 2017/001/R

VERIFICATION OF SAFETY CRITERIA

As the complete behaviour of the change is reflected in satisfying the safety criteria for the change, no safety requirements are set at system or change level. Nevertheless, safety requirements can be placed on the architecture and the components affected by the change.

AMC1 ATS.OR.205(b)(6) Safety assessment and assurance of changes to the functional system

ED Decision 2017/001/R

MONITORING OF INTRODUCED CHANGE

The air traffic services provider should ensure that within the safety assessment process for a change, the monitoring criteria, that are to be used to demonstrate that the safety case remains valid during the operation of the changed functional system, are identified and documented. These criteria are specific to the change and should be such that they indicate that:

- (a) the assumptions made in the argument remain valid;
- (b) critical proxies remain as predicted in the safety case and are no more uncertain; and
- (c) other properties that may be affected by the change remain within the bounds predicted by the safety case.

GM1 ATS.OR.205(b)(6) Safety assessment and assurance of changes to the functional system

ED Decision 2017/001/R

MONITORING OF INTRODUCED CHANGE

- (a) Monitoring is intended to maintain confidence in the safety case during operation of the changed functional system. At entry into service, the safety criteria become performance criteria rather than design criteria. Monitoring is, therefore, only applicable following entry into service of the change.
- (b) Monitoring is likely to be of internal parameters of the functional system that provide a good indication of the performance of the service. These parameters may not be directly observable at the service level, i.e. at the interface of the service with the operational context. For example, where a function is provided by multiple redundant resources, the availability of the function will be so high that monitoring it may not be useful. However, monitoring the availability of individual resources, which fail much more often, may be a useful indicator of the performance of the overall function.

ATS.OR.210 Safety criteria

Regulation (EU) 2017/373

- (a) An air traffic services provider shall determine the safety acceptability of a change to a functional system, based on the analysis of the risks posed by the introduction of the change, differentiated on basis of types of operations and stakeholder classes, as appropriate.
- (b) The safety acceptability of a change shall be assessed by using specific and verifiable safety criteria, where each criterion is expressed in terms of an explicit, quantitative level of safety risk or another measure that relates to safety risk.
- (c) An air traffic services provider shall ensure that the safety criteria:
 - (1) are justified for the specific change, taking into account the type of change;
 - (2) when fulfilled, predict that the functional system after the change will be as safe as it was before the change or the air traffic services provider shall provide an argument justifying that:
 - (i) any temporary reduction in safety will be offset by future improvement in safety; or
 - (ii) any permanent reduction in safety has other beneficial consequences;
 - (3) when taken collectively, ensure that the change does not create an unacceptable risk to the safety of the service;
 - (4) support the improvement of safety whenever reasonably practicable.

AMC1 ATS.OR.210(a) Safety criteria

ED Decision 2017/001/R

OTHER MEASURES RELATED TO SAFETY RISKS

When the air traffic services provider specifies the safety criteria with reference to another measure that relates to safety risk, it should use one or more of the following:

- (a) proxies;
- (b) recognised standards and/or codes of practice; and
- (c) the safety performance of the existing functional system or a similar system elsewhere.

AMC2 ATS.OR.210(a) Safety criteria

ED Decision 2017/001/R

OTHER MEASURES RELATED TO SAFETY RISKS — PROXIES

Proxies for safety risk, used as safety criteria for those parts of the functional system affected by the change, can only be employed when:

- (a) a justifiable causal relationship exists between the proxy and the harmful effect, e.g. proxy increase/decrease causes risk increase/decrease;
- (b) a proxy is sufficiently isolated from other proxies to be treated independently; and
- (c) the proxy is measurable, quantitatively or qualitatively, to an adequate degree of certainty.

GM1 ATS.OR.210(a) Safety criteria

ED Decision 2017/001/R

SAFETY CRITERIA IN TERMS OF PROXIES FOR SAFETY RISKS

- (a) In the safety assessment of functional systems, it may not always be possible or desirable to specify safety criteria in terms of quantitative values of risk. Instead, safety criteria may be defined in terms of other measures that are related to risk. These measures are called proxies and they need to meet the requirements for a proxy as stated in [AMC2 ATS.OR.210\(a\)](#). For examples of their use, see [GM1 to AMC1 ATS.OR.205\(b\)\(4\)](#).
- (b) A proxy is some measurable property that can be used to represent the value of something else. In the safety assessment of functional systems, the value of a proxy may be used as a substitute for a value of risk, providing it meets the requirements for a proxy as stated in [AMC2 ATS.OR.210\(a\)](#). Examples of proxies are the frequency of airspace infringements, runway incursions, false alert rate, head-down time, limited sight, level of situation awareness, fraction of read back errors, reduced vigilance, amount of turbulence, distraction of controller's attention, inappropriate pilot behaviour, system availability, information integrity and service continuity.

An example of the concept of using a different but specific quantity to assess an actually relevant quantity is the transposition/measure of an aircraft's altitude which is in terms of barometric pressure or the transposition/measure of an aircraft's airspeed which is in terms of dynamic pressure.

- (c) A proxy is a measure of a certain property along the causal trajectory between the hazard/event and the harmful effects of the hazard/event in question (see Figure 5). The causal relationship between the proxy and the accident must be justified in the safety case, i.e. it must satisfy [AMC2 ATS.OR.210\(a\)](#). This means that the accident trajectory must be modelled and analysed such that the causal relationship can be assured but without the need to evaluate the quantitative nature of this relationship. It is assumed that since the proxy lies between the hazard/event and the accident, then there is a quantitative causal relationship between the rate of the hazard/event's occurrence and the rate of the proxy's occurrence. As a consequence, the variation of values of the proxy correlates with values of the hazards/events rate of occurrence and the value of the rate at which the harmful effects occur, i.e. the accident rate, and this relationship is a monotonically increasing one. This means that when the proxy value, e.g. Proxy₁, increases/decreases, the associated risk value of the related accident, e.g. Accident₁, increases/decreases accordingly.

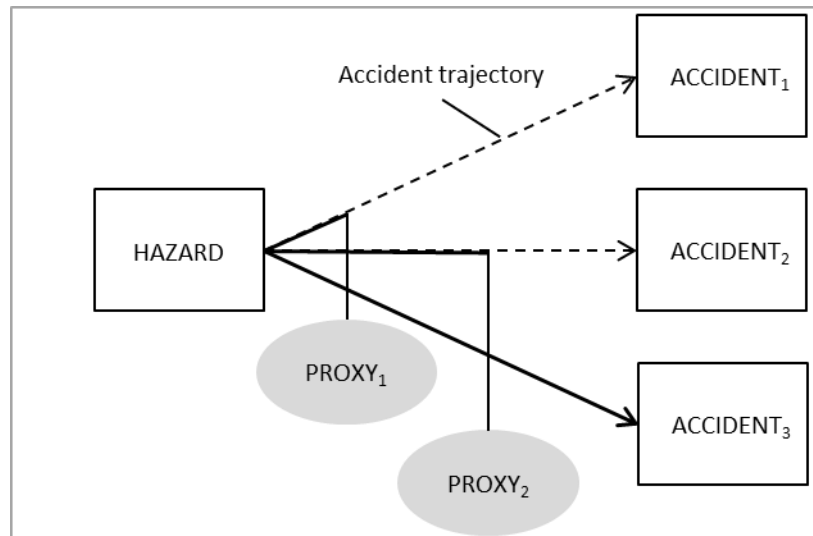

Figure 5: Use of proxies along accident trajectories

- (d) Proxies might be preferred where the extra effort needed to identify, describe and analyse a complete set of sequences of events from the occurrence of a hazard to the occurrence of an accident or incident has no added value in the safety assessment. The intrinsic reasons for the amount of the extra effort are the number of significantly different event sequences, the complexity of some accident scenarios, the existence of many barriers preventing the occurrence of a hazard developing into an accident and the lack of evidence on the probability of some events or the frequency of occurrence of some external circumstances and factors. The usage of proxies might then make the safety assessment more tractable and comprehensible and increase the quality of the risk analysis.
- (e) The main advantages of proxies are the easy recognition of safety issues by operational staff involved in the safety assessment, and the direct focus on the analysis and mitigation of the identified hazards and safety issues introduced or affected by the change.
- (f) The main disadvantage of using proxies is that it is not possible to express risk by a uniform measure. However, the value of the proxy should be measurable.
- (g) For further details on the use of proxies, please refer to [GM1 to AMC1 ATS.OR.205\(b\)\(4\)](#), which contains two examples to assist in the selection and use of proxies in safety analysis.

ATS.OR.215 Licensing and medical certification requirements for air traffic controllers

Regulation (EU) 2017/373

An air traffic services provider shall ensure that air traffic controllers are properly licensed and hold a valid medical certificate, in accordance with Regulation (EU) 2015/340.

SECTION 3 — SPECIFIC HUMAN FACTORS REQUIREMENTS FOR AIR TRAFFIC CONTROL SERVICE PROVIDERS

ATS.OR.300 Scope

Regulation (EU) 2017/373

This section establishes the requirements to be met by the air traffic control service provider with regard to human performance in order to:

- (a) prevent and mitigate the risk that air traffic control service is provided by air traffic controllers with problematic use of psychoactive substances;
- (b) prevent and mitigate the negative effects of stress on air traffic controllers to ensure the safety of air traffic;
- (c) prevent and mitigate the negative effects of fatigue on air traffic controllers to ensure the safety of air traffic.

ATS.OR.305 Responsibilities of air traffic control service providers with regard to the problematic use of psychoactive substances by air traffic controllers

Regulation (EU) 2017/373

- (a) An air traffic control service provider shall develop and implement a policy, with related procedures, in order to ensure that the problematic use of psychoactive substances does not affect the provision of air traffic control service.
- (b) Without prejudice to provisions laid down in Directive 95/46/EC of the European Parliament and of the Council¹ and to the applicable national legislation on testing of individuals, the air traffic control service provider shall develop and implement an objective, transparent and non-discriminatory procedure for the detection of cases of problematic use of psychoactive substances by air traffic controllers. This procedure shall take into account provisions laid down in point ATCO.A.015 of Regulation (EU) 2015/340.
- (c) The procedure in point (b) shall be approved by the competent authority.

AMC1 ATS.OR.305(a) Responsibilities of air traffic control service providers with regard to the problematic use of psychoactive substances by air traffic controllers

ED Decision 2017/001/R

POLICY AND PROCEDURES

Within the context of the policy, the air traffic control service provider should:

- (a) provide training or educational material to air traffic controllers relating to:

¹ Directive 95/46/EC of the European Parliament and of the Council of 24 October 1995 on the protection of individuals with regard to the processing of personal data and on the free movement of such data (OJ L 281, 23.11.1995, p. 31).

- (1) the effects of psychoactive substances on individuals and subsequently on air traffic control service provision;
 - (2) established procedures within its organisation regarding this issue; and
 - (3) their individual responsibilities with regard to legislation and policies on psychoactive substances.
- (b) make available appropriate support for air traffic controllers who are dependent on psychoactive substances;
- (c) encourage air traffic controllers who think that they may have such a problem to seek and accept help made available by their air traffic control service provider;
- (d) ensure that air traffic controllers are treated in a consistent, just and equitable manner as regards the problematic use of psychoactive substances; and
- (e) establish and implement principles and procedures for occurrence investigation and analysis to consider the problematic use of psychoactive substances as a contributing factor.

GM1 ATS.OR.305(a) Responsibilities of air traffic control service providers with regard to the problematic use of psychoactive substances by air traffic controllers

ED Decision 2017/001/R

POLICY

- (a) Guidance for the development and implementation of the policy is contained in ICAO Doc 9654 'Manual on Prevention of Problematic Use of Substances in the Aviation Workplace', First Edition - 1995, and in particular:
- (1) Attachment A (pp. 27–34) as regards elements for the definition and the implementation of policy and programme;
 - (2) Chapter 3 (pp. 9–12) as regards the identification, treatment, and rehabilitation of staff, with related supporting material, available in Attachment C (pp. 61–68); and
 - (3) Attachment D (pp. 69–75) as regards the employment consequences of problematic use of substances.

TRAINING AND EDUCATION PROGRAMMES

- (b) Guidance for the development and implementation of training and education programmes is contained in ICAO Doc 9654 'Manual on Prevention of Problematic Use of Substances in the Aviation Workplace', First Edition - 1995, in particular:
- (1) Chapter 2 (pp. 6–7) as regards the education of the workforce and educational material, with related supporting material available in Attachment A (pp. 35–48); and
 - (2) Attachment B (pp. 49–59) and Attachment F (pp. 87–94), where extracts from the ICAO Manual of Civil Aviation Medicine are provided

GM2 ATS.OR.305(a) Responsibilities of air traffic control service providers with regard to the problematic use of psychoactive substances by air traffic controllers

ED Decision 2017/001/R

THIRD PARTY ASSISTANCE TO AIR TRAFFIC CONTROLLERS

The air traffic control service provider may employ third-party assistance. Such assistance should be made freely available to air traffic controllers who are dependent on psychoactive substances.

AMC1 ATS.OR.305(b) Responsibilities of air traffic control service providers with regard to the problematic use of psychoactive substances by air traffic controllers

ED Decision 2017/001/R

PROCEDURE FOR THE DETECTION OF CASES OF PROBLEMATIC USE OF PSYCHOACTIVE SUBSTANCES

The objective, transparent and non-discriminatory procedure should specify:

- (a) the mechanisms and responsibilities for its initiation;
- (b) its applicability in terms of timing and locations;
- (c) the person(s)/body responsible for testing the individual;
- (d) the testing process;
- (e) thresholds for psychoactive substances;
- (f) the process to be followed in case of detection of problematic use of psychoactive substances by an air traffic controller; and
- (g) the appeal process.

GM1 ATS.OR.305(b) Responsibilities of air traffic control service providers with regard to the problematic use of psychoactive substances by air traffic controllers

ED Decision 2017/001/R

PROCEDURE FOR THE DETECTION OF CASES OF PROBLEMATIC USE OF PSYCHOACTIVE SUBSTANCES

Guidance for the development and implementation of the procedure for detection of cases of psychoactive substances is contained in ICAO Doc 9654 'Manual on Prevention of problematic use of Substances in the Aviation Workplace', First Edition - 1995, particularly in Chapter 5 (pp. 15–23) and Attachment E (pp. 77–85) as regards biochemical testing programmes, with related supporting material.

ATS.OR.310 Stress

Regulation (EU) 2017/373

In accordance with point [ATS.OR.200](#), an air traffic control service provider shall:

- (a) develop and maintain a policy for the management of air traffic controllers' stress, including the implementation of a critical incident stress management programme;
- (b) provide air traffic controllers with education and information programmes on the prevention of stress, including critical incident stress, complementing human factors training provided in accordance with Sections 3 and 4 of Subpart D of Annex I to Regulation (EU) 2015/340.

GM1 ATS.OR.310 Stress

ED Decision 2017/001/R

EXPLANATION OF THE FUNDAMENTALS OF STRESS

(a) Introduction

- (1) The job of an air traffic controller is considered to be responsible and demanding, and at times can lead to the experience of high levels of stress. The combination of skills and knowledge required to complete air traffic control tasks is wide. Visual spatial skills, perception, information processing, image and pattern recognition, prioritising, logical problem-solving, application of rules and procedures and decision-making form core skills to which we can add interpersonal communication, teamwork and technical vocabulary usage.
- (2) Air traffic control also requires to constantly adapt to an ever-changing traffic picture and work environment within restricted time constraints. This has the potential to lead to considerable work pressure. In contrast, there may be times when traffic flows are low and controllers experience relatively low levels of activity. For some controllers, this may bring its own kind of stress due to the increased efforts required to maintain vigilance under light traffic load.
- (3) Thus, the work of an air traffic controller has the potential to induce high levels of stress; however, the stress experienced by controllers is always unique to the individual and their interaction with their environment.
- (4) 'Stress' is a term that is in common use within everyday language and can mean different things to different people depending on the context in which it is used. In lay terms, stress is often used to describe an external pressure experienced by an individual whilst at the same time encompassing the subjective experience of this pressure. Usually the term is used in a negative way. In this sense, the lay use of the term 'stress' encompasses both the cause and the effect, and this can lead to confusion as to its meaning.

(b) Technical definitions of stress

- (1) Even in its technical use, the word 'stress' is sometimes used when the term 'stressor' (or pressure) would be more appropriate, referring to the cause of a stress experience. Stressors can be internal (cognitive or physical) or external (environmental) to the individual and may be defined as any activity, event or other stimulus that causes the individual to experience stress.

- (2) It is helpful to clarify the way the term ‘stress’ and other technical terms are used. For the purposes of this guidance material, stress is defined following the Transactional Model of Stress. This views stress as the outcomes experienced by an individual when faced with a potentially stressful event. The experience of the event as negatively stressful (distress), neutral or positive (eustress) is based on the individual’s perception of their ability to manage the event. Under this definition, stress is a manifestation in the individual of usually negative effects, which can lead to a decrease in performance and negative health effects.
- (3) A stressor can also act to improve performance when it is a stimulus to increase arousal and improves the outputs of an individual in the short to medium term. Too much arousal paradoxically leads to an inverse effect and subsequent detriment in performance.
- (4) Acute stress is, as its name suggests, episodic and occurring for short periods of time. In most cases, the cause of the stress is eliminated by the air traffic controller taking action to manage the situation leading to stress. High levels of acute stress may lead to hyper-arousal and may leave an air traffic controller feeling exhausted. It is important to identify work situations that lead to this acute stress and manage this within the work schedule.
- (5) Chronic stress differs from acute stress only in that it is ongoing and even low levels of continuous chronic stress can lead to performance degradation and serious health implications, if it is not addressed. Chronic stress is insidious in its nature and a sufferer may become so accustomed to the sensations that they are unaware of the long-term negative effects. Chronic stress commonly leads to a sense of inability to cope.
- (6) Both acute and chronic stresses have the potential to lead individuals into hyper-aroused states which may result in panic where task and skill performance, planning, reasoning and judgement are significantly impaired. In such instances, a well-practised but incorrect action, for that particular circumstance, may be performed when an alternative and more appropriate response is required.
- (7) Chronic stress may result in a condition known as burnout. Burnout is generally identified by the following characteristics: disaffection with the job leading to a decrease in motivation with an associated decrease, perceived or otherwise, in performance.

(c) Sources of stress

Broadly speaking, the stress experienced by an air traffic controller at work is a function of their underlying background levels of stress, related to lifestyle, health and well-being, personality, organisational/work environment, levels of satisfaction with life generally, and the acute stress imposed by and operational conditions at any given time. There are three major sources of stress: environmental, work-related, and personal.

- (1) Environmental/physical stressors
 - (i) Physical stressors are underlying conditions that can either be internal to the body (e.g. pain, hunger, lack of sleep, exhaustion), or external environmental factors (e.g. noise pollution, overcrowding, excess heat). The common factor among all of these stressors is that they all create a physically uncomfortable environment that can cause stress. Stress is not solely dependent on the intensity of a stimulus, but also on the duration of exposure. For example, a low-pitched but persistent noise can cause as much stress as a sudden loud noise.

-
- (ii) In the air traffic control room, some common environmental/physical stressors could be:
 - (A) uncomfortable temperature;
 - (B) cramped workspace;
 - (C) air quality;
 - (D) lighting conditions; and
 - (E) intrusive noise or vibration.
 - (2) Work-related stressors
 - (i) Stress in the workplace can come from a variety of sources besides physical stimuli. Some of these include:
 - (A) continuing high levels of workload near or above the maximum traffic handling capacity of an air traffic controller;
 - (B) a heterogeneous traffic mix where aircraft have varying levels of equipment and considerable variability in pilot skills;
 - (C) unsuitable or unreliable equipment;
 - (D) inappropriate, vague procedures;
 - (E) complex equipment which is insufficiently understood or mistrusted;
 - (F) supervision of trainees or less experienced colleagues;
 - (G) workload and task breakdown not being matched to the level of technical skill of the controller, lack of support or too much support (interference);
 - (H) role ambiguity, where it is unclear where the responsibilities lie;
 - (I) interpersonal conflict with colleagues, other professionals;
 - (J) poor management relations (social dialogue), working conditions, e.g. rostering; and
 - (K) unusual or emergency situations.
 - (ii) Incidents, including emergencies and accidents, that lead controllers to feel that they are not coping may lead to the experience of critical incident stress; this, in turn, may impair performance in varying degrees.
 - (3) Personal stressors
 - (i) Personal stressors include the range of events that occur throughout people's lives but external to the workplace. The belief that such stressors can be left at home, however, is a myth, and these personal stressors accompany air traffic controllers to work every day.
 - (ii) Personal issues such as health, personal life, living situation and major life events (deaths, births, marriages, and moving house) add to the background level of stress that individuals have to cope with. Where these are excessive, they can interfere with work due to the distraction they cause and the mental effort they require to resolve them.

- (iii) Stress is also considered to have a contagious quality, which happens when a stressed person or stressed persons create stressful situations for those around them.

(d) Signs of stress in the individual

Signs of stress are many and varied. Some of the most commonly observed are shown below:

(1) Physiological

- (i) Cardiovascular: increased pulse rate, elevated blood pressure, chest pains;
- (ii) Respiratory: shortness of breath, tightness of chest, hyperventilation, dizziness;
- (iii) Gastrointestinal: loss of appetite, gas pain, abdominal cramps, indigestion, diarrhoea, nausea;
- (iv) Sweaty palms;
- (v) Aching neck, jaw and back muscles;
- (vi) Trembling;
- (vii) Sleep disturbance, tiredness;
- (viii) Itching;
- (ix) Getting easily startled;
- (x) Susceptibility to minor illnesses; and
- (xi) Other: headaches, muscular tension, general weakness, psychosomatic symptoms.

(2) Psychological

- (i) Emotional: anger, guilt, mood swings, low self-esteem, depression and anxiety;
- (ii) Concentration problems, forgetfulness;
- (iii) Pessimism;
- (iv) Difficulty in making decisions;
- (v) Irritability;
- (vi) Loss of interest;
- (vii) Loss of self-control; and
- (viii) Loss of confidence.

(3) Behavioural

- (i) Self-medication, drugs or alcohol;
- (ii) Excess fatigue;
- (iii) Sleep disruption;
- (iv) Social withdrawal;
- (v) Absenteeism;
- (vi) Staff turnover rates; and

(vii) Job performance decrements.

(e) Impact of stress on air traffic controllers' performance of air traffic control tasks

Any source of stress has the potential to create unique subjective experiences in different individuals, and these may be positive or negative experiences or something in between.

(f) Negative experiences of stress

There is a number of ways in which stress experienced by air traffic controllers can be manifested in the performance of air traffic control tasks. Some of these are listed in Table 1, but, in general terms, performance of tasks decreases due to the detrimental effects that high levels of stress can have on perception, awareness, decision-making and judgement. In the longer term, health and well-being may also be compromised, leading to decreased performance of air traffic controllers.

Table 1 below shows the effects on air traffic controller performance which can be linked to stress and which can potentially have very significant implications for the safety performance of an operation.

Difficulty in concentrating and reduced vigilance — easily distracted.
Errors, omissions, mistakes, incorrect actions, poor judgment and memory.
Tendency to cut corners, skip items and look for the easiest way out.
Either slowness (due to lack of interest) or hyperactivity (due to adrenaline).
Focusing on easily manageable details while ignoring serious threats.
Tendency to pass responsibility on to others.
Fixation on single issues or even a mental block.
Unwillingness to make decisions — decisions are postponed or take longer to be made.
Fewer plans and backup plans are made.
Increase in risk-taking, leading to an increase in the number of violations, especially when frustrated with failures.
Excessively hurried actions — due to adrenaline and alertness level, there is a tendency to act very quickly even when there is no time pressure. Hurried actions increase the chance of errors.
In cases of significantly high stress, a controller will often:
(1) return to old procedures that may no longer be applicable, appropriate or safe;
(2) use non-standard phraseology when communicating;
(3) return to the use of one's native language; and/or
(4) look for items in a place where they used to be, but are no longer located.

Table 1: Effects of stress on physical and mental performance of air traffic control tasks

(g) Mitigation of stress in the individual and the organisation

Air traffic control service providers have a duty to take care of their employees and the customers of their services. They should aim at mitigating the negative effects of stress. This is best achieved by ensuring that a range of preventative measures as well as countermeasures are in place. These include:

- (1) adoption of a stress policy and/or a critical incident stress management policy within the organisation;
- (2) completion of regular risk assessment of sources of occupational stress and its effects on individuals and operations;
- (3) employee stress level monitoring;

- (4) adoption of stress intervention/mitigation/prevention practices and, where the organisation identifies a source of stress, use of a stress team/committee;
- (5) stress management training for all levels of employees;
- (6) education and prevention programmes on stress; and
- (7) staff support mechanisms (e.g. peer counselling, professional support from health practitioners, critical incident stress management (CISM) programmes);
- (8) adequate rostering allowing time to evacuate stress; and
- (9) promotion of sports or relaxation activities.

AMC1 ATS.OR.310(a) Stress

ED Decision 2017/001/R

STRESS MANAGEMENT POLICY

- (a) The air traffic controllers' stress management policy should:
 - (1) declare the commitment to proactively and systematically monitor and manage stress, and describe the expected benefits for the safety of operations;
 - (2) be signed by the accountable manager;
 - (3) reflect organisational commitments regarding the implementation of a critical incident stress management programme;
 - (4) be communicated, with visible endorsement, throughout the air traffic control service provider;
 - (5) include the commitment to:
 - (i) provide appropriate resources;
 - (ii) consider the best practices;
 - (iii) enforce stress management programme(s) as a responsibility of managers, staff involved in stress management and air traffic controllers;
 - (6) be periodically reviewed to ensure it remains relevant and appropriate.
- (b) In accordance with the policy in point (a), the air traffic control service provider should establish and implement:
 - (1) procedures for critical incident stress management;
 - (2) principles and procedures to enable stress reporting;
 - (3) principles and procedures for occurrence investigation and analysis to consider stress as contributing factor; and
 - (4) method(s) for the identification and management of the effect of air traffic controllers' stress on the safety of operations.

GM1 ATS.OR.310(a) Stress

ED Decision 2017/001/R

CRITICAL INCIDENT STRESS MANAGEMENT

The purpose of critical incident stress management (CISM) programmes is to prepare an organisation for the potential aftermath of an incident. These programmes come in a number of different forms, but have the added benefit of providing education on the effects of stress, how stress affects performance and stress management, even when the incident is relatively minor and perhaps personal to the individual.

Guidance for the implementation of a CISM programme may be found in the EUROCONTROL document: 'Human Factors — Critical Incident Stress Management: User Implementation Guidelines', edition 2.0 of 24 October 2008.

GM1 ATS.OR.310(b) Stress

ED Decision 2017/001/R

INFORMATION AND EDUCATION PROGRAMMES

Scientific material proposed as guidance for information and education programmes on stress may be found in the EUROCONTROL document 'Human Factors Module — Stress', edition 1.0 of 15 March 1996.

ATS.OR.315 Fatigue

Regulation (EU) 2017/373

In accordance with point [ATS.OR.200](#), an air traffic control service provider shall:

- (a) develop and maintain a policy for the management of air traffic controllers' fatigue;
- (b) provide air traffic controllers with information programmes on the prevention of fatigue, complementing human factors training provided in accordance with Sections 3 and 4 of Subpart D of Annex I to Regulation (EU) 2015/340.

GM1 ATS.OR.315 Fatigue

ED Decision 2017/001/R

EFFECTS OF FATIGUE

Guidance material on fatigue and its effects on safety-relevant aviation professionals may be found in Chapter 2 'Scientific principles for fatigue management' of ICAO Doc 9966 'Manual for the Oversight of Fatigue Management Approaches', second edition 2016.

AMC1 ATS.OR.315(a) Fatigue

ED Decision 2017/001/R

FATIGUE MANAGEMENT POLICY

- (a) The air traffic controllers' fatigue management policy should:
 - (1) declare the commitment to proactively and systematically monitor and manage fatigue and describe the expected benefits for the safety of operations;
 - (2) be signed by the accountable manager;

- (3) address the mitigation of the operational impact of air traffic controllers' fatigue;
 - (4) be communicated, with visible endorsement, throughout the air traffic control service provider;
 - (5) include a commitment to:
 - (i) consider the best practices;
 - (ii) provide appropriate resources; and
 - (iii) enforce fatigue management as a responsibility of managers, staff involved in fatigue management procedures and air traffic controllers;
 - (6) be periodically reviewed to ensure it remains relevant and appropriate.
- (b) In accordance with the policy in point (a), the air traffic control service provider should establish and implement:
- (1) principles and procedures to enable fatigue reporting;
 - (2) principles and procedures for occurrence investigation and analysis to consider fatigue as contributing factor;
 - (3) procedures for the identification and management of the effect of fatigue on the safety of operations.

GM1 to AMC1 ATS.OR.315(a) Fatigue

ED Decision 2017/001/R

FATIGUE TAXONOMY

When establishing procedures to enable air traffic controllers to report when fatigued, an associated taxonomy for fatigue should be established.

GM2 to AMC1 ATS.OR.315(a) Fatigue

ED Decision 2017/001/R

FATIGUE IN OCCURRENCE INVESTIGATION AND ANALYSIS

Fatigue may have a significant impact on the performance of air traffic controllers and consequently on the safety of air operations. Therefore, when investigating occurrences, the air traffic control service providers should analyse the occurrence for fatigue as a contributing factor.

The analysis of available occurrence reports where fatigue was identified as contributing factor, generated by the air traffic control service providers or by other sources, could support the implementation and the improvement of fatigue management.

GM3 to AMC1 ATS.OR.315(a) Fatigue

ED Decision 2017/001/R

IDENTIFICATION AND MANAGEMENT OF THE EFFECT OF FATIGUE ON THE SAFETY OF OPERATIONS

- (a) The following non exhaustive list contains some of the initiatives that the air traffic control service provider may undertake in order to identify air traffic controllers' fatigue:

- (1) establishment of a procedure allowing air traffic controllers to report when fatigued, and promotion of its use. Templates for such reporting procedure could be established;
 - (2) utilisation of system support to manage rostering principles and thresholds established in accordance with [ATS.OR.320](#), also highlighting criticalities in advance;
 - (3) undertaking fatigue surveys;
 - (4) application of scientific principles on fatigue and fatigue management and their effect on the operational and organisational context.
- (b) The knowledge and understanding of the underlying scientific principles of fatigue, as well of its potential impact on the safety of operations, may represent a considerable added value for the effectiveness of fatigue management arrangements established within the organisation. For this purpose, the air traffic control service provider might consider making available education and information programmes for staff involved in fatigue management, such as operational and safety managers, staff in charge of managing the rostering system, staff in charge of occurrence investigation.
- (c) Activities air traffic control service providers could undertake to monitor the effectiveness of the established fatigue management arrangements may be but are not limited to the following:
- (1) verification of the allocation and implementation of duty and rest periods in accordance with the rostering principles established in [ATS.OR.320](#);
 - (2) collection and analysis of data related to planned versus achieved rosters, and in particular:
 - (i) exceedances of planned working hours and reasons generating exceedances;
 - (ii) variation of the nature of the duty (office work, operational air traffic control service provision, training, etc.);
 - (iii) operational circumstances which required a modification of established duty and rest periods; and
 - (iv) swapped shifts between air traffic controllers and impact on the established fatigue management principles;
 - (3) verification of the use and of the effectiveness of the procedure allowing air traffic controllers to self-declare fatigue, when such procedure is established; and
 - (4) analysis if specific roster patterns generate fatigue and, as a consequence, sickness or cases of provisional inability in accordance with Commission Regulation (EU) 2015/340.

GM1 ATS.OR.315(b) Fatigue

ED Decision 2017/001/R

INFORMATION PROGRAMMES

Information programmes may consist of lectures, leaflets, posters, CDs, and any other informative material to raise the awareness of the effects of fatigue on the individuals and on air traffic control service provision, and to advise on the need and the means to manage it. When choosing the most appropriate information programme and the medium, the air traffic control service provider should evaluate the level of awareness of its staff of fatigue management, the type of operations (e.g. single-

person operations, nightshifts), and the periodicity of human factors training in the scope of refresher training.

GM2 ATS.OR.315(b) Fatigue

ED Decision 2017/001/R

INFORMATION PROGRAMMES

Scientific material proposed as guidance for information programmes on fatigue may be found in the document 'Fatigue and Sleep Management: Personal strategies for decreasing the effects of fatigue in air traffic control' (Brussels: Human Factors Management Business Division (DAS/HUM), EUROCONTROL, 2005).

ATS.OR.320 Air traffic controllers' rostering system(s)

Regulation (EU) 2017/373

- (a) An air traffic control service provider shall develop, implement and monitor a rostering system in order to manage the risks of occupational fatigue of air traffic controllers through a safe alternation of duty and rest periods. Within the rostering system, the air traffic control service provider shall specify the following elements:
- (1) maximum consecutive working days with duty;
 - (2) maximum hours per duty period;
 - (3) maximum time providing air traffic control service without breaks;
 - (4) the ratio of duty periods to breaks when providing air traffic control service;
 - (5) minimum rest periods;
 - (6) maximum consecutive duty periods encroaching the night time, if applicable, depending upon the operating hours of the air traffic control unit concerned;
 - (7) minimum rest period after a duty period encroaching the night time;
 - (8) minimum number of rest periods within a roster cycle.
- (b) An air traffic control services provider shall consult those air traffic controllers who will be subject to the rostering system, or, as applicable, their representatives, during its development and its application, to identify and mitigate risks concerning fatigue which could be due to the rostering system itself.

GM1 ATS.OR.320(a) Air traffic controllers' rostering system(s)

ED Decision 2017/001/R

STRUCTURE AND VALUES OF THE ROSTERING SYSTEM

The selection and the regular revision of an appropriate structure and of appropriate values of the rostering system, in accordance with [ATS.OR.320\(a\)](#) and which fit the intended operations, should be based upon:

- (1) scientific principles;
- (2) data gathered by the air traffic control service provider; and
- (3) best practices.

AMC1 ATS.OR.320(a)(6);(7) Air traffic controllers' rostering system(s)

ED Decision 2017/001/R

NIGHT TIME

Night time should be considered as the time between midnight and 05.59.

GM1 ATS.OR.320(b) Air traffic controllers' rostering system(s)

ED Decision 2017/001/R

AIR TRAFFIC CONTROLLERS' INVOLVEMENT

Additional guidance concerning the involvement of air traffic controllers in the definition of rostering systems is available in EUROCONTROL Study on Shiftwork practices — ATM and related Industries, edition 1.0 of 14 April 2006.

SECTION 4 - REQUIREMENTS FOR COMMUNICATIONS

ATS.OR.400 Aeronautical mobile service (air-ground communications) – general

Commission Implementing Regulation (EU) 2020/469

- (a) An air traffic services provider shall use voice or data link, or both, in air-ground communications for air traffic services purposes.
- (b) When direct pilot-controller two-way voice or data link communications are used for the provision of air traffic control service, recording facilities shall be provided by the air traffic services provider on all such air-ground communication channels.
- (c) When direct air-ground two-way voice or data link communications are used for the provision of flight information service, including AFIS, recording facilities on all such air-ground communication channels shall be provided by the air traffic services provider, unless otherwise prescribed by the competent authority.

GM1 ATS.OR.400(a) Aeronautical mobile service (air-ground communications) — general

ED Decision 2020/008/R

RELIABILITY AND AVAILABILITY OF RADIO COMMUNICATIONS AND NAVIGATION AIDS

When providing ATS surveillance service, the air traffic services provider should ensure that the levels of reliability and availability of communication systems are such that the possibility of system failures or significant degradations is very remote, and that adequate backup facilities are provided.

Guidance material and information pertaining to system reliability and availability may be found in ICAO Annex 10 Volume I, and in particular in Attachment F ‘Guidance material concerning reliability and availability of radio communications and navigation aids’ thereto.

ATS.OR.405 Use and availability of the VHF emergency frequency

Commission Implementing Regulation (EU) 2020/469

- (a) As laid down in Article 3d, the VHF emergency frequency (121,500 MHz) shall be used for genuine emergency purposes, including any of the following:
 - (1) to provide a clear channel between aircraft in distress or emergency and a ground station when the normal channels are being utilised for other aircraft;
 - (2) to provide a VHF communication channel between aircraft and aerodromes, not normally used by international air services, in case of an emergency condition arising;
 - (3) to provide a common VHF communication channel between aircraft, either civil or military, and between such aircraft and surface services, involved in common search and rescue operations, prior to changing when necessary to the appropriate frequency;
 - (4) to provide air-ground communication with aircraft when airborne equipment failure prevents the use of the regular channels;

- (5) to provide a channel for the operation of emergency locator transmitters (ELTs), and for communication between survival craft and aircraft engaged in search and rescue operations;
 - (6) to provide a common VHF channel for communication between civil aircraft and intercepting aircraft or intercept control units and between civil or intercepting aircraft and air traffic services units in the event of interception of the civil aircraft.
- (b) An air traffic services provider shall provide the frequency 121.500 MHz at:
- (1) all area control centres and flight information centres;
 - (2) aerodrome control towers and approach control units serving international aerodromes and international alternate aerodromes;
 - (3) any additional location designated by the competent authority, where the provision of that frequency is considered necessary to ensure immediate reception of distress calls or to serve the purposes specified in point (a).

GM1 ATS.OR.405 Use and availability of the VHF emergency frequency

ED Decision 2020/008/R

LISTENING WATCH OF THE VHF EMERGENCY CHANNEL

Requirements for air traffic services units to maintain continuous guard on the emergency frequency 121.500 MHz are specified in SERA.14080(b) of Regulation (EU) No 923/2012.

GM1 ATS.OR.405(a)(3) Use and availability of the VHF emergency frequency

ED Decision 2020/008/R

USE OF VHF EMERGENCY CHANNEL IN CASE OF HANDLING OF DISTRESS TRAFFIC

The use of the frequency 121.500 MHz for the purpose outlined in point (a)(3) of ATS.OR.405 is to be avoided if it interferes in any way with the efficient handling of distress traffic.

GM1 ATS.OR.405(b) Use and availability of the VHF emergency frequency

ED Decision 2020/008/R

VHF EMERGENCY CHANNEL

Where two or more of the air traffic services units listed in point (b) of ATS.OR.405 are co-located, provision of the frequency 121.500 MHz at one would meet the requirement.

ATS.OR.410 Aeronautical mobile service (air-ground communications) – flight information service

Commission Implementing Regulation (EU) 2020/469

- (a) An air traffic services provider shall ensure, to the practicable extent and as approved by the competent authority, that air-ground communication facilities enable two-way communications to take place between a flight information centre and appropriately equipped aircraft flying anywhere within the flight information region.
- (b) An air traffic services provider shall ensure that air-ground communication facilities enable direct, rapid, continuous and static-free two-way communications to take place between an AFIS unit and appropriately equipped aircraft operating within the airspace referred to in point [ATS.TR.110\(a\)\(3\)](#).

GM1 ATS.OR.410(a) Aeronautical mobile service (air-ground communications) — flight information service

ED Decision 2020/008/R

Whenever practicable, air-ground communication facilities for flight information service should permit direct, rapid, continuous and static-free two-way communications.

ATS.OR.415 Aeronautical mobile service (air-ground communications) – area control service

Commission Implementing Regulation (EU) 2020/469

An air traffic services provider shall ensure that air-ground communication facilities enable two-way communications to take place between a unit providing area control service and appropriately equipped aircraft flying anywhere within the control area or areas.

AMC1 ATS.OR.415 Aeronautical mobile service (air-ground communications) — area control service

ED Decision 2020/008/R

Whenever practicable, air-ground communication facilities for area control service should permit direct, rapid, continuous and static-free two-way communications.

GM1 ATS.OR.415 Aeronautical mobile service (air-ground communications) — area control service

ED Decision 2020/008/R

Where air-ground voice communication channels are used for area control service by air-ground communicators, suitable arrangements should be made to permit direct pilot-controller voice communications, as and when required.

ATS.OR.420 Aeronautical mobile service (air-ground communications) – approach control service

Commission Implementing Regulation (EU) 2020/469

- (a) An air traffic services provider shall ensure that air-ground communication facilities enable direct, rapid, continuous and static-free two-way communications to take place between the unit providing approach control service and appropriately equipped aircraft under its control.
- (b) Where the unit providing approach control service functions as a separate unit, air-ground communications shall be conducted over communication channels provided for its exclusive use.

ATS.OR.425 Aeronautical mobile service (air-ground communications) – aerodrome control service

Commission Implementing Regulation (EU) 2020/469

- (a) An air traffic services provider shall ensure that air-ground communication facilities enable direct, rapid, continuous and static-free two-way communications to take place between an aerodrome control tower and appropriately equipped aircraft operating at any distance within 45 km (25 NM) of the aerodrome concerned.
- (b) Where conditions warrant, an air traffic services provider shall provide separate communication channels for the control of traffic operating on the manoeuvring area.

GM1 ATS.OR.425(b) Aeronautical mobile service (air-ground communications) — aerodrome control service

ED Decision 2020/008/R

Guidance on the establishment of communication channels for the control of traffic operating on the manoeuvring area may be found in Appendix A to Chapter 8, Section 2 of ICAO Doc 9426 'Air Traffic Services Planning Manual'.

ATS.OR.430 Aeronautical fixed service (ground-ground communications) – general

Commission Implementing Regulation (EU) 2020/469

- (a) An air traffic services provider shall ensure that direct-speech or data link, or both, communications are used in ground-ground communications for air traffic services purposes.
- (b) When communication for ATC coordination purposes is supported by automation, an air traffic services provider shall ensure that the failure of such automated coordination is presented clearly to the air traffic controller or controllers responsible for coordinating flights at a transferring unit.

GM1 ATS.OR.430(a) Aeronautical fixed service (ground-ground communications) — general

ED Decision 2020/008/R

Indication by time of the speed with which the communication should be established is provided as a guide to communication services, particularly to determine the types of communication channels required, e.g. that ‘instantaneous’ is intended to refer to communications which effectively provide for immediate access between air traffic controllers; ‘15 seconds’ to accept switchboard operation and ‘5 minutes’ to mean methods involving retransmission.

GM1 ATS.OR.430(b) Aeronautical fixed service (ground-ground communications) — general

ED Decision 2020/008/R

FAILURE OF AUTOMATED COORDINATION

In case of failure of the automated coordination, the air traffic controller should facilitate the required coordination using prescribed alternative methods, as established by the air traffic services provider in operation manuals.

ATS.OR.435 Aeronautical fixed service (ground-ground communications) – communication within a flight information region

Commission Implementing Regulation (EU) 2020/469

- (a) Communications between air traffic services units
- (1) An air traffic services provider shall ensure that a flight information centre has facilities for communications with the following units providing a service within its area of responsibility:
 - (i) the area control centre;
 - (ii) approach control units;
 - (iii) aerodrome control towers;
 - (iv) AFIS units.
 - (2) An air traffic services provider shall ensure that an area control centre, in addition to being connected with the flight information centre as prescribed in point (1), has facilities for communications with the following units providing a service within its area of responsibility:
 - (i) approach control units;
 - (ii) aerodrome control towers;
 - (iii) AFIS units;
 - (iv) air traffic services reporting offices, when separately established.

-
- (3) An air traffic services provider shall ensure that an approach control unit, in addition to being connected with the flight information centre and the area control centre as prescribed in points (1) and (2), has facilities for communications with:
- (i) the associated aerodrome control tower or towers;
 - (ii) with relevant AFIS unit or units;
 - (iii) the associated air traffic services reporting office or offices, when separately established.
- (4) An air traffic services provider shall ensure that an aerodrome control tower or an AFIS unit, in addition to being connected with the flight information centre, the area control centre and the approach control unit as prescribed in points (1), (2) and (3), has facilities for communications with the associated air traffic services reporting office, when separately established.
- (b) Communications between air traffic services units and other units
- (1) An air traffic services provider shall ensure that a flight information centre and an area control centre have facilities for communications with the following units providing a service within their respective area of responsibility:
- (i) appropriate military units;
 - (ii) the meteorological services provider or providers serving the centre;
 - (iii) the aeronautical telecommunication station serving the centre;
 - (iv) appropriate aircraft operators' offices;
 - (v) the rescue coordination centre or, in the absence of such centre, any other appropriate emergency service;
 - (vi) the international NOTAM office serving the centre.
- (2) An air traffic services provider shall ensure that an approach control unit, an aerodrome control tower and an AFIS unit have facilities for communications with the following units providing a service within their respective area of responsibility:
- (i) appropriate military units;
 - (ii) rescue and emergency services (including ambulance, firefighting etc.);
 - (iii) the meteorological services provider serving the unit concerned;
 - (iv) the aeronautical telecommunication station serving the unit concerned;
 - (v) the unit providing apron management service, when separately established.
- (3) The communication facilities required under points (b)(1)(i) and (b)(2)(i) shall include provisions for rapid and reliable communications between the air traffic services unit concerned and the military unit or units responsible for control of interception operations within the area of responsibility of the air traffic services unit, in order to fulfil obligations set out in Section 11 of the Annex to Implementing Regulation (EU) No 923/2012.
- (c) Description of communication facilities
- (1) The communication facilities required under point (a), point (b)(1)(i) and points (b)(2)(i), (b)(2)(ii) and (b)(2)(iii) shall include provisions for:

- (i) communications by direct speech alone, or in combination with data link communications, whereby for the purpose of transfer of control using radar or ADS-B, the communications are established instantaneously, and for other purposes, the communications are normally established within 15 seconds;
 - (ii) printed communications, when a written record is required; the message transit time for such communications is no longer than 5 minutes.
- (2) In all cases not covered by point (c)(1), the communication facilities shall include provisions for:
- (i) communications by direct speech alone, or in combination with data link communications, whereby the communications are normally established within 15 seconds;
 - (ii) printed communications, when a written record is required; the message transit time for such communications are no longer than 5 minutes.
- (3) In all cases where automatic transfer of data to or from air traffic services computers, or both ways, is required, suitable facilities for automatic recording shall be provided.
- (4) The communication facilities required under points (b)(2)(i);(ii);(iii) shall include provisions for communications by direct speech arranged for conference communications whereby the communications are normally established within 15 seconds.
- (5) All facilities for direct-speech or data link communications between air traffic services units and between air traffic services units and other units described under points (b)(1) and (b)(2) shall be provided with automatic recording.

GM1 ATS.OR.435(a) Aeronautical fixed service (ground-ground communications) — communication within a flight information region

ED Decision 2020/008/R

PROCEDURES FOR DIRECT-SPEECH COMMUNICATIONS

An air traffic services provider should develop appropriate procedures for direct-speech communications to permit immediate connections to be made for very urgent calls concerning the safety of aircraft, and the interruption, if necessary, of less urgent calls in progress at the time.

GM1 ATS.OR.435(a);(b) Aeronautical fixed service (ground-ground communications) — communication within a flight information region

ED Decision 2020/008/R

SUPPLEMENTARY FACILITIES TO THOSE PRESCRIBED FOR COMMUNICATION

The communication facilities in points (a) and (b) of ATS.OR.435 could be supplemented, as and where necessary, by facilities for other forms of visual or audio communications; for example, closed-circuit television or separate information processing systems.

GM1 ATS.OR.435(c)(4) Aeronautical fixed service (ground-ground communications) — communication within a flight information region

ED Decision 2020/008/R

FACILITY FOR DIRECT SPEECH

The facility for direct speech does not necessarily refer to permanently dedicated point-to-point telephone lines.

ATS.OR.440 Aeronautical fixed service (ground-ground communications) – communication between flight information regions

Commission Implementing Regulation (EU) 2020/469

- (a) An air traffic services provider shall ensure that flight information centres and area control centres have facilities for communications with all adjacent flight information centres and area control centres. Those communication facilities shall in all cases include provisions for messages in a form suitable for retention as a permanent record, and delivery in accordance with transit times specified by ICAO regional air navigation agreements.
- (b) An air traffic services provider shall ensure that facilities for communications between area control centres serving contiguous control areas, in addition, include provisions for direct-speech and, where applicable, data link communications, with automatic recording, whereby for the purpose of transfer of control using ATS surveillance data, the communications are established instantaneously, and for other purposes, the communications are normally established within 15 seconds.
- (c) When so required by agreement between the States concerned in order to eliminate or reduce the need for interceptions in the event of deviations from assigned track, an air traffic services provider shall ensure that facilities for communications between adjacent flight information centres or area control centres other than those mentioned in point (b):
 - (1) include provisions for direct speech alone, or in combination with data link communications;
 - (2) permit communications to be established normally within 15 seconds;
 - (3) are provided with automatic recording.

- (d) An air traffic services provider concerned shall ensure that adjacent air traffic services units are connected in all cases where special circumstances exist.
- (e) Wherever local conditions are such that it is necessary to clear aircraft into a controlled airspace prior to departure, the air traffic services provider or providers concerned shall ensure that the air traffic services units delivering the clearance to the aircraft are connected with the air traffic control unit serving the adjacent controlled airspace.
- (f) The communication facilities supporting connections to be established in accordance with points (d) and (e) shall include provisions for communications by direct speech alone, or in combination with data link communications, with automatic recording, whereby for the purpose of transfer of control using ATS surveillance, the communications are established instantaneously, and for other purposes, the communications are normally established within 15 seconds.
- (g) An air traffic services provider shall provide suitable facilities for automatic recording in all cases where automatic exchange of data between air traffic services computers is required.

GM1 ATS.OR.440(d) Aeronautical fixed service (ground-ground communications) — communication between flight information regions

ED Decision 2020/008/R

Special circumstances may be due to traffic density, types of aircraft operations and/or the manner in which the airspace is organised and may exist even if the control areas and/or control zones are not contiguous or have not (yet) been established.

ATS.OR.445 Communications for the control or management of vehicles other than aircraft on manoeuvring areas at aerodromes

Commission Implementing Regulation (EU) 2020/469

- (a) Except where communication by a system of visual signals is deemed to be adequate, an air traffic services provider shall ensure two-way radiotelephony communication facilities for either of the following services:
 - (1) aerodrome control service for the control of vehicles on the manoeuvring area;
 - (2) AFIS for the management of vehicles on the manoeuvring area where such service is provided in accordance with point [ATS.TR.305\(f\)](#).
- (b) The need for separate communication channels for the control or for the management of the vehicles on the manoeuvring area shall be determined subject to a safety assessment.
- (c) Automatic recording facilities on all channels referred to in point (b) shall be provided.

GM1 ATS.OR.445(a) Communications for the control or management of vehicles other than aircraft on manoeuvring areas at aerodromes

ED Decision 2020/008/R

SYSTEM OF VISUAL SIGNALS FOR COMMUNICATION BETWEEN AERODROME AIR TRAFFIC SERVICES UNITS AND VEHICLES ON THE MANOEUVRING AREA

- (a) When communications by a system of visual signals is deemed to be adequate, or in the case of radio communication failure, the signals given hereunder should have the meaning indicated in the table below.

LIGHTS SIGNAL FROM AERODROME CONTROL	MEANING
Green flashes	Permission to cross landing area or to move onto taxiway
Steady red	Stop
Red flashes	Move off the landing area or taxiway and watch out for aircraft
White flashes	Vacate manoeuvring area in accordance with local instructions

- (b) In emergency conditions or if the signals in point (a) are not observed, the signal given hereunder should be used for runways or taxiways equipped with a lighting system and should have the meaning indicated in the table below.

LIGHT SIGNAL	MEANING
Flashing runway or taxiway lights	Vacate the runway and observe the tower for light signal

ATS.OR.450 Automatic recording of surveillance data

Commission Implementing Regulation (EU) 2020/469

An air traffic services provider shall ensure that surveillance data from primary and secondary radar equipment or other systems (e.g. ADS-B, ADS-C), used as an aid to air traffic services, are automatically recorded for use in accident and incident investigations, search and rescue, air traffic services and surveillance systems evaluation and training.

GM1 ATS.OR.450 Automatic recording of surveillance data

ED Decision 2020/008/R

RECORDING OF VISUAL SURVEILLANCE SYSTEM DATA

‘Other systems’ include also visual surveillance systems utilised in the remote provision of aerodrome air traffic services.

ATS.OR.455 Retention of recorded information and data

Commission Implementing Regulation (EU) 2020/469

- (a) An air traffic services provider shall retain for a period of at least 30 days the following:
 - (1) recordings of communications channels, as specified in points [ATS.OR.400\(b\) and \(c\)](#);
 - (2) recordings of data and communications, as specified in points [ATS.OR.435\(c\)\(3\) and \(5\)](#);
 - (3) automatic recordings, as specified in point [ATS.OR.440](#);
 - (4) recordings of communications, as specified in point [ATS.OR.445](#);
 - (5) recordings of data, as specified in point [ATS.OR.450](#);
 - (6) paper flight progress strips, electronic flight progress and coordination data.
- (b) When the recordings and logs listed in point (a) are pertinent to accident and incident investigations, they shall be retained for longer periods until it is evident that they will no longer be required.

ATS.OR.460 Background communication and aural environment recording

Commission Implementing Regulation (EU) 2020/469

- (a) Unless otherwise prescribed by the competent authority, air traffic services units shall be equipped with devices that record background communication and the aural environment at air traffic controller's, or the flight information service officer's, or the AFIS officer's work stations, as applicable, capable of retaining the information recorded during at least the last 24 hours of operation.
- (b) Such recordings shall only be used for the investigation of accidents and incidents which are subject to mandatory reporting.

SECTION 5 – REQUIREMENTS FOR INFORMATION

ATS.OR.500 Meteorological information – General

Commission Implementing Regulation (EU) 2020/469

- (a) An air traffic services provider shall ensure that up-to-date information on existing and forecast meteorological conditions is made available to the relevant air traffic services units as necessary for the performance of their respective functions.
- (b) An air traffic services provider shall ensure that available detailed information on the location, vertical extent, direction and rate of movement of meteorological phenomena in the vicinity of the aerodrome, and particularly in the climb-out and approach areas, which could be hazardous to aircraft operations, is supplied to the relevant air traffic services units.
- (c) The information in points (a) and (b) shall be supplied in such a form as to require a minimum of interpretation on the part of air traffic services personnel and with a frequency which satisfies the requirements of the air traffic services units concerned.

ATS.OR.505 Meteorological information for flight information centres and area control centres

Commission Implementing Regulation (EU) 2020/469

- (a) An air traffic services provider shall ensure that flight information centres and area control centres are supplied with the meteorological information stipulated in point MET.OR.245(f) of Annex V, particular emphasis being given on the occurrence or expected occurrence of deterioration in a weather element as soon as this can be determined. Those reports and forecasts shall cover the flight information region or control area and such other areas, if so prescribed by the competent authority.
- (b) An air traffic services provider shall ensure that flight information centres and area control centres are provided, at suitable intervals, with current pressure data for setting altimeters, for locations specified by the flight information centre or area control centre concerned.

GM1 ATS.OR.505(a) Meteorological information for flight information centres and area control centres

ED Decision 2020/008/R

INFORMATION CONCERNING WEATHER DETERIORATION

Certain changes in meteorological conditions are construed as deterioration in a weather element, although they are not ordinarily considered as such. An increase in temperature may, for example, adversely affect the operation of certain types of aircraft.

ATS.OR.510 Meteorological information for units providing approach control service

Commission Implementing Regulation (EU) 2020/469

- (a) An air traffic services provider shall ensure that units providing approach control service are supplied with meteorological information for the airspace and the aerodromes with which they are concerned, as stipulated in point [MET.OR.242\(b\)](#) of Annex V.
- (b) An air traffic services provider shall ensure that, where multiple anemometers are used, the displays to which they are related are clearly marked to identify the runway and section of the runway monitored by each anemometer.
- (c) An air traffic services provider shall ensure that units providing approach control service are provided with current pressure data for setting altimeters, for locations specified by the unit providing approach control service.
- (d) An air traffic services provider shall ensure that units providing approach control service for final approach, landing and take-off are equipped with surface wind display or displays. The display or displays shall be related to the same location or locations of observation and be fed from the same sensor or sensors as the corresponding display or displays in the aerodrome control tower or AFIS unit, or both, and in the aeronautical meteorological station, where such a station exists.
- (e) An air traffic services provider shall ensure that units providing approach control service for final approach, landing and take-off at aerodromes where runway visual range values are assessed by instrumental means, are equipped with display or displays permitting read-out of the current runway visual range values. The display or displays shall be related to the same location or locations of observation and be fed from the same sensor or sensors as the corresponding display or displays in the aerodrome control tower or AFIS unit, or both, and in the aeronautical meteorological station, where such a station exists.
- (f) An air traffic services provider shall ensure that units providing approach control service for final approach, landing and take-off at aerodromes where the height of cloud base is assessed by instrumental means, are equipped with display or displays permitting read-out of the current values of the height of cloud base. The displays shall be related to the same location or locations of observations and be fed from the same sensor or sensors as the corresponding display or displays in the aerodrome control tower or AFIS unit, or both, and in the aeronautical meteorological station, where such a station exists.
- (g) An air traffic services provider shall ensure that units providing approach control service for final approach, landing and take-off are supplied with available information on wind shear which could adversely affect aircraft on the approach or take-off paths or during circling approach.

ATS.OR.515 Meteorological information for aerodrome control towers and AFIS units

Commission Implementing Regulation (EU) 2020/469

- (a) An air traffic services provider shall ensure that aerodrome control towers and, unless otherwise prescribed by the competent authority, AFIS units are supplied with meteorological information for the aerodrome with which they are concerned as stipulated in point [MET.OR.242\(a\)](#) of Annex V.

- (b) An air traffic services provider shall ensure that aerodrome control towers and AFIS units are provided with current pressure data for setting altimeters for the aerodrome concerned.
- (c) An air traffic services provider shall ensure that aerodrome control towers and AFIS units are equipped with surface wind display or displays. The display or displays shall be related to the same location or locations of observation and be fed from the same sensor or sensors as the corresponding display or displays in the aeronautical meteorological station, where such a station exists. Where multiple sensors are used, the displays to which they are related shall be clearly marked to identify the runway and section of the runway monitored by each sensor.
- (d) An air traffic services provider shall ensure that aerodrome control towers and AFIS units at aerodromes where runway visual range values are measured by instrumental means, are equipped with display or displays permitting read-out of the current runway visual range values. The display or displays shall be related to the same location or locations of observation and be fed from the same sensor or sensors as the corresponding display or displays in the aeronautical meteorological station, where such a station exists.
- (e) An air traffic services provider shall ensure that aerodrome control towers and AFIS units at aerodromes where the height of cloud base is assessed by instrumental means, are equipped with display or displays permitting read-out of the current values of the height of cloud base. The displays shall be related to the same location or locations of observations and be fed from the same sensor or sensors as the corresponding display or displays in the aerodrome control tower and AFIS units and in the aeronautical meteorological station, where such a station exists.
- (f) An air traffic services provider shall ensure that aerodrome control tower and AFIS units are supplied with available information on wind shear which could adversely affect aircraft on the approach or take-off paths or during circling approach, and aircraft on the runway during the landing roll or take-off run.
- (g) An air traffic services provider shall ensure that aerodrome control towers and AFIS units and/or other appropriate units are supplied with aerodrome warnings, in accordance with point [MET.OR.215\(b\)](#) of Annex V

ATS.OR.520 Information on aerodrome conditions and the operational status of associated facilities

Commission Implementing Regulation (EU) 2020/469

An air traffic services provider shall ensure that aerodrome control towers, AFIS units and units providing approach control service are kept currently informed of the operationally significant conditions of the movement area, including the existence of temporary hazards, and the operational status of any associated facilities at the aerodrome or aerodromes with which they are concerned, as reported by the aerodrome operator.

ATS.OR.525 Information on the operational status of navigation services

Commission Implementing Regulation (EU) 2020/469

- (a) An air traffic services provider shall ensure that air traffic services units are kept currently and timely informed of the operational status of radio navigation services and visual aids essential

for take-off, departure, approach and landing procedures within their area of responsibility, and of those radio navigation services and visual aids essential for surface movement.

- (b) An air traffic services provider shall establish appropriate arrangements in accordance with point [ATM/ANS.OR.B.005\(f\)](#) of Annex III to ensure that information in point (a) of this point with regard to the GNSS services is provided.

GM1 ATS.OR.525(a) Information on the operational status of navigation services

ED Decision 2020/008/R

PROVISION OF INFORMATION WITH RESPECT TO VISUAL AND NON-VISUAL NAVIGATION AIDS

Guidance material regarding the provision of information to air traffic services units with respect to visual and non-visual navigation aids is contained in ICAO Doc 9426 'Air Traffic Services Planning Manual' (Appendix A to Chapter 10, Part I).

AMC1 ATS.OR.525(b) Information on the operational status of navigation services

ED Decision 2020/008/R

PROVISION OF INFORMATION WITH RESPECT TO GNSS

The air traffic services provider should establish formal arrangements with the European Satellite Service Provider (ESSP) and, when feasible, with other providers of satellite services operating within the area of responsibility of the air traffic services provider.

GM1 ATS.OR.525(b) Information on the operational status of navigation services

ED Decision 2020/008/R

PROVISION OF INFORMATION WITH RESPECT TO GNSS

Service providers of satellite-based augmentation systems should be considered as CNS providers within the scope of Regulation (EU) 2017/373, hence they should be duly certified. The ESSP has been certified and is overseen by EASA; as such, this provider is obliged to comply with the requirement in ATM/ANS.OR.B.005(f) in Annex III and to conclude appropriate agreements with the air navigation service (including air traffic services) providers concerned. Currently, these arrangements are stipulated in accordance with Section 9.3 of Attachment D to ICAO Annex 10, Volume I. When these arrangements are established, the ESSP provides information on the availability of its services to the relevant air navigation services providers.

ATS.OR.530 Forwarding of braking action information

Commission Implementing Regulation (EU) 2020/469

If an air traffic services provider receives by a voice communication a special air-report concerning braking action which does not correspond to what was reported, it shall inform without delay the appropriate aerodrome operator.

SUBPART B — TECHNICAL REQUIREMENTS FOR PROVIDERS OF AIR TRAFFIC SERVICES (ATS.TR)

SECTION 1 — GENERAL REQUIREMENTS

ATS.TR.100 Objectives of the air traffic services (ATS)

Commission Implementing Regulation (EU) 2020/469

The objectives of the air traffic services shall be to:

- (a) prevent collisions between aircraft;
- (b) prevent collisions between aircraft on the manoeuvring area and obstructions on that area;
- (c) expedite and maintain an orderly flow of air traffic;
- (d) provide advice and information useful for the safe and efficient conduct of flights;
- (e) notify appropriate organisations regarding aircraft in need of search and rescue aid, and assist such organisations as required.

ATS.TR.105 Divisions of the air traffic services

Commission Implementing Regulation (EU) 2020/469

The air traffic services shall comprise the services identified as follows:

- (a) the air traffic control service, to accomplish the objectives as in points (a), (b) and (c) of point [ATS.TR.100](#), this service being divided in three parts as follows:
 - (1) area control service: the provision of air traffic control service for controlled flights, except for those parts of such flights described in points (2) and (3) of this point, in order to accomplish the objectives established in points (a) and (c) of point [ATS.TR.100](#);
 - (2) approach control service: the provision of air traffic control service for those parts of controlled flights associated with arrival or departure, in order to accomplish the objectives established in points (a) and (c) of point [ATS.TR.100](#); and
 - (3) aerodrome control service: the provision of air traffic control service for aerodrome traffic, except for those parts of flights described in point (2) of this point, in order to accomplish the objectives established in points (a), (b) and (c) of point [ATS.TR.100](#).
- (b) the flight information service or air traffic advisory service, or both, to accomplish the objective established in point (d) of point [ATS.TR.100](#);
- (c) the alerting service, to accomplish the objective established in point (e) of point [ATS.TR.100](#)

AMC1 ATS.TR.105(b) Divisions of the air traffic services

ED Decision 2020/008/R

AIR TRAFFIC ADVISORY SERVICE IMPLEMENTATION

Class F airspace should only be implemented where the air traffic services are inadequate for the provision of air traffic control service and the limited advice on collision hazards otherwise provided by flight information service is not adequate. Where air traffic advisory service is implemented, this

should be considered as a temporary measure only until such time as it can be replaced by air traffic control service or, in cases where the traffic situation changes such that advisory service is no longer required, replaced by flight information service.

AMC2 ATS.TR.105(b) Divisions of the air traffic services

ED Decision 2020/008/R

COORDINATION IN RESPECT OF THE AIR TRAFFIC ADVISORY SERVICE PROVISION

Air traffic services units providing air traffic advisory service should apply the coordination procedures in ATS.TR.230 and ATS.OR.150 with respect to such aircraft having elected to use this type of service.

GM1 ATS.TR.105(b) Divisions of the air traffic services

ED Decision 2020/008/R

AIR TRAFFIC ADVISORY SERVICE

- (a) The air traffic advisory service within airspace class F should be provided with the objective of making information on collision hazards more effective than it would be in the mere flight information service provision.
- (b) The air traffic advisory service may be provided to aircraft conducting instrument flight rules (IFR) flights in advisory airspace or on advisory routes (class F airspace), specified by the State concerned.
- (c) Air traffic advisory service does not afford the degree of safety and cannot assume the same responsibilities as air traffic control service in respect of the avoidance of collisions, since information regarding the disposition of traffic in the area concerned available to the unit providing air traffic advisory service may be incomplete.
- (d) The efficiency of air traffic advisory service will depend largely on the procedures and practices in use. Its establishment in line with the organisation, procedures and equipment of area control service, taking into account the basic differences of the two services, will help to ensure a high degree of efficiency and promote uniformity in the various provisions of air traffic advisory service. For example, exchange of information by the units concerned on the progress of an aircraft from one advisory area into an adjacent control area or terminal control area (TMA), and vice versa, will help to relieve pilots from repeating details of their flight plans already filed; also, use of standard ATC phraseology, preceded by the verbs 'suggest' or 'advise', will facilitate the pilot's understanding of air traffic advisory service intelligence.
- (e) Air traffic services units providing air traffic advisory service:
 - (1) advise the aircraft to depart at the time specified and to cruise at the levels indicated in the flight plan if they do not foresee any conflict with other known traffic;
 - (2) suggest to aircraft a course of action by which a potential hazard may be avoided, giving priority to an aircraft already in advisory airspace over other aircraft desiring to enter such advisory airspace; and
 - (3) pass on to aircraft traffic information comprising the same information as that prescribed for area control service.
- (f) The criteria used as a basis for action under points (e)(2) and (e)(3) should be at least those laid down for aircraft operating in controlled airspace and should take into account the limitations

inherent in the provision of air traffic advisory service, navigation facilities and air-ground communications prevailing in the region.

ATS.TR.110 Establishment of the units providing air traffic services

Commission Implementing Regulation (EU) 2020/469

- (a) The air traffic services shall be provided by units established as follows:
- (1) flight information centres shall be established to provide flight information service and alerting service within flight information regions unless the responsibility of providing such services within a flight information region is assigned to an air traffic control unit having adequate facilities for the discharge of such responsibility;
 - (2) air traffic control units shall be established to provide air traffic control service, flight information service and alerting service within control areas, control zones and at controlled aerodromes;
 - (3) AFIS units shall be established to provide flight information service and alerting service at AFIS aerodromes and within the airspace associated with such aerodromes.
- (b) Air traffic services reporting office or offices or other arrangements shall be established for the purpose of receiving reports concerning air traffic services and flight plans submitted before departure.

GM1 ATS.TR.110(b) Establishment of the units providing air traffic services

ED Decision 2020/008/R

ATS REPORTING OFFICE

The reference to an ATS reporting office denotes the functions to be performed by such an office. When addressing the provision of air traffic services, Member States should ensure that the functions of an ATS reporting office are fully implemented by:

- (a) establishing physical offices; and/or
- (b) assigning the duties to any air traffic services unit; and/or
- (c) agreeing with one or more Member State(s) to provide a joint service; and/or
- (d) establishing proper arrangements for the provision of the service by an external agency or external agencies.

ATS.TR.115 Identification of air traffic services units

Commission Implementing Regulation (EU) 2020/469

- (a) Air traffic services units shall be unambiguously named as follows:
- (1) an area control centre or flight information centre shall normally be identified by the name of a nearby town or city or geographic feature or area;

- (2) an aerodrome control tower or approach control unit shall normally be identified by the name of the aerodrome at which it is providing services or by the name of a nearby town or city or geographic feature or area;
 - (3) an AFIS unit shall normally be identified by the name of the aerodrome at which it is providing services or by the name of a nearby town or city or geographic feature or area.
- (b) The name of the air traffic services units and services shall be complemented by one of the following suffixes, as appropriate:
- (1) area control centre – CONTROL;
 - (2) approach control – APPROACH;
 - (3) approach control radar arrivals – ARRIVAL;
 - (4) approach control radar departures – DEPARTURE;
 - (5) air traffic control unit (in general) when providing ATS surveillance services – RADAR;
 - (6) aerodrome control – TOWER;
 - (7) surface movement control – GROUND;
 - (8) clearance delivery – DELIVERY;
 - (9) flight information centre – INFORMATION;
 - (10) AFIS unit – INFORMATION.

GM1 ATS.TR.115(b)(9);(10) Identification of air traffic services units

ED Decision 2020/008/R

NAMING OF FLIGHT INFORMATION CENTRE AND AFIS UNIT

Particular attention should be paid when naming flight information centres and AFIS units providing services in contiguous portions of airspace, in order to avoid duplications which could lead to misunderstandings. In this case, the names attached to the respective suffixes of the two units should be different. In this way, compliance with point (a) of ATS.TR.115 concerning unambiguous identification of air traffic services units is ensured.

ATS.TR.120 Language for communication between air traffic services units

Commission Implementing Regulation (EU) 2020/469

Except when communications between air traffic services units are conducted in a mutually agreed language, the English language shall be used for such communications.

ATS.TR.125 Expression of vertical position of aircraft

Commission Implementing Regulation (EU) 2020/469

- (a) For flights in areas where a transition altitude is established, the vertical position of the aircraft shall, except as provided for in point (b), be expressed in terms of altitudes at or below the transition altitude and in terms of flight levels at or above the transition level. While passing through the transition layer, the vertical position shall be expressed in terms of flight levels when climbing and in terms of altitudes when descending.
- (b) When an aircraft which has been given clearance to land, or when at AFIS aerodromes an aircraft which has been informed that the runway is available for landing, is completing its approach using atmospheric pressure at aerodrome elevation (QFE), the vertical position of the aircraft shall be expressed in terms of height above aerodrome elevation during that portion of its flight for which QFE may be used, except that it shall be expressed in terms of height above runway threshold elevation:
 - (1) for instrument runways if the threshold is 2 m (7 ft) or more below the aerodrome elevation;
 - (2) for precision approach runways.

ATS.TR.130 Determination of the transition level

Commission Implementing Regulation (EU) 2020/469

- (a) The appropriate air traffic services unit shall establish the transition level to be used in areas where a transition altitude is established, for the appropriate period of time on the basis of QNH (altimeter subscale setting to obtain elevation when on the ground) reports and forecast mean sea level pressure, if required.
- (b) The transition level shall be located above the transition altitude such that at least a nominal 300 m (1 000 ft) vertical separation minimum is ensured between aircraft flying concurrently at the transition altitude and at the transition level.

GM1 ATS.TR.130 Determination of the transition level

ED Decision 2020/008/R

DETERMINATION OF A COMMON TRANSITION LEVEL FOR TWO OR MORE AERODROMES

Where a common transition altitude has been established for two or more aerodromes which are so closely located as to require coordinated procedures, the appropriate air traffic services units should establish a common transition level to be used at any given time in the vicinity of the aerodrome and, when relevant, in the TMA concerned.

GM1 ATS.TR.130(b) Determination of the transition level

ED Decision 2020/008/R

EXPLANATION FOR THE CONSISTENT NEED FOR THE TERM 'NOMINAL' IN EU REGULATORY MATERIAL

- (a) Introduction

ICAO Doc 4444 'PANS ATM' Section 5.3.2 stipulates that the 'vertical separation minimum shall be a 'nominal' 300 m (1 000 ft) below Flight Level 290'. However, the term 'nominal' is used inconsistently in ICAO provisions which relate to the vertical separation minimum. An example

of such inconsistency may be found in ICAO Doc 7030 'EUR Regional Supplementary Procedures' Chapter 6.3.1.2 (transposed with some modifications as point (b) of ATS.TR.130) which states that 'the transition level shall be located at least 300 m (1 000 ft) above the transition altitude to permit the transition altitude and the transition level to be used concurrently in cruising flight, with vertical separation ensured'.

In transposing ICAO provisions into the EU regulatory framework, it is considered that consistent descriptions should be used in relation to the determination of the transition level, in order to ensure that the flexibility permitted by ICAO through the use of the term 'nominal' is maintained.

(b) History of the vertical separation minimum

The advent in the early 1950s of commercial turbo jet aircraft operating at high levels necessitated a re-evaluation of the vertical separation minimum and thus, in June 1954, ICAO established the Vertical Separation Minima Panel. Based on the work of this Panel, the use of 1 000 ft vertical separation minimum between IFR traffic below 29 000 ft was agreed by ICAO at the 1958 RAC/SAR Divisional Meeting and incorporated within PANS ATM Section 5.3.2 as highlighted above.

Although ICAO does not define 'nominal', when transposing ICAO provisions into EU legislation, it is necessary to have clear and consistent understanding of the terms in relation to the establishment of a transition level. Accordingly, the Agency notes the following factors relating to the use of the term 'nominal':

- (1) 300 m is equal to 984.3 ft, whilst 1 000ft is equal to 304.8 m;
- (2) the vertical distance between flights at two altitudes or two flight levels, for example FL 090 and FL 100, will only be 300 m (1 000 ft) under conditions where the ICAO Standard Atmosphere (ISA) — ICAO Doc 7488 'Manual of the ICAO Standard Atmosphere' prevails. When conditions in the atmosphere differ from the ICAO ISA, the vertical distance will be greater/less than 300 m (1 000 ft) respectively.

Moreover, in addition to the equivalence between 300 m and 1 000 ft, other factors including variances between aircraft altimeter settings, aircraft total vertical error (TVE) and the dimensions of an aircraft above and below its static pressure source are encompassed within the term 'nominal'.

(c) Determination of the transition level

The transition level is a function of the transition altitude of the aerodrome concerned and the difference between the aerodrome QNH altimeter setting value and the standard pressure setting. Regarding the relationship between pressure and height, the following is to be noted:

- (1) The relationship between height and pressure is non-linear. The specification of the ISA is set out in ICAO Doc 7488 'Manual of the ICAO Standard Atmosphere'.
- (2) The real atmosphere is rarely consistent with the ISA. Consequently, variations in the conditions specified in the ISA generate differences in the vertical distances between surfaces of equal atmospheric pressure, dependent upon an aircraft's level within a particular column of air.
- (3) Altimeters are calibrated against the ISA as defined in ICAO Doc 7488.
- (4) The standard pressure setting is 1013.25 hPa as defined in ICAO Doc 7488.

In those instances where an aerodrome QNH of 1 013 hPa exists, a vertical difference of 6.8 ft exists between 1 013 hPa and 1 013.25 hPa (equivalent to a vertical distance of 27.3 ft per 1 hPa at mean sea level in accordance with the ISA). Where a transition altitude of 6 000 ft exists, this would result in a transition level of FL 75 as detailed below:

- (1) Transition altitude 6 000 ft + 1 000 ft (ICAO Doc 7030 EUR Chapter 6.3.1.2) = 7 000 ft
- (2) $(1\,013.25\text{ hPa} - 1\,013\text{ hPa}) \times 27.3\text{ ft} = 6.825\text{ ft} = 7\text{ ft}$
- (3) Transition level = 7 000 ft + 7 ft rounded up to nearest 500 ft increment = FL 75

Consequently, in those instances when the reported aerodrome QNH is 1 013 hPa, a flight level is 'lost' through the need to 'round up' by 493 ft; thus providing a vertical separation of 1 493 ft between aircraft cruising concurrently at the transition altitude and the transition level. In high-density/high-complexity airspace, the loss of airspace capacity that this represents, coupled with the second order effect of increased controller workload, is considered to have a significant impact by industry.

Through the application of a vertical separation minimum of 300 m and considering the 'nominal' equivalence between 300 m and 1 000 ft, ICAO implicitly endorses a vertical separation of only 984.3 ft. Continuing the example given above, the inclusion of the term 'nominal' would permit the transition level to be FL 70, resulting in a vertical separation of 993 ft between aircraft cruising concurrently at the transition altitude and the transition level; a value which remains within the 300 m/984.3 ft equivalence. In this instance, the practical safety effect of a 7 ft reduction in the vertical distance between aircraft is considered to be operationally insignificant.

ATS.TR.135 Minimum cruising level for IFR flights

Commission Implementing Regulation (EU) 2020/469

- (a) Air traffic control units shall not assign cruising levels below the minimum flight altitudes established by the Member States, except when specifically authorised by the competent authority.
- (b) Air traffic control units shall:
 - (1) determine the lowest usable flight level or levels for the whole or parts of the control area for which they are responsible;
 - (2) assign flight levels at or above such level or levels;
 - (3) pass the lowest usable flight level or levels on to pilots on request.

GM1 ATS.TR.135(b) Minimum cruising level for IFR flights

ED Decision 2020/008/R

The lowest usable flight level is that flight level which corresponds to, or is immediately above, the established minimum flight altitude.

ATS.TR.140 Provision of altimeter setting information

Commission Implementing Regulation (EU) 2020/469

- (a) The appropriate air traffic services units shall at all times have available for transmission to aircraft in flight, on request, the information required to determine the lowest flight level which

will ensure adequate terrain clearance on routes or on segment of routes for which this information is required.

- (b) Flight information centres and area control centres shall have available for transmission to aircraft, on request, an appropriate number of QNH reports or forecast pressures for the flight information regions and control areas for which they are responsible, and for those adjacent.
- (c) The flight crew shall be provided with the transition level in due time prior to reaching it during descent.
- (d) Except when it is known that the aircraft has already received the information in a directed transmission, an QNH altimeter setting shall be included in:
 - (1) the descent clearance, when first cleared to an altitude below the transition level;
 - (2) approach clearances or clearances to enter the traffic circuit;
 - (3) taxi clearances for departing aircraft.
- (e) An QFE altimeter setting as described in point [ATS.TR.125\(b\)](#) shall be provided to aircraft on request or on a regular basis in accordance with local arrangements.
- (f) The appropriate air traffic services units shall round down the altimeter settings provided to aircraft to the nearest lower whole hectopascal.

GM1 ATS.TR.140(c) Provision of altimeter setting information

ED Decision 2020/008/R

The transition level may be included in the approach clearances or provided when requested by the pilot.

GM2 ATS.TR.140(c) Provision of altimeter setting information

ED Decision 2020/008/R

The provision of transition level may be accomplished by voice communications, ATIS broadcast or data link.

ATS.TR.145 Suspension of visual flight rules operations on and in the vicinity of an aerodrome

Commission Implementing Regulation (EU) 2020/469

- (a) Any or all VFR operations on and in the vicinity of an aerodrome may be suspended whenever safety requires such action by any of the following units, persons or authorities:
 - (1) the approach control unit or the appropriate area control centre;
 - (2) the aerodrome control tower;
 - (3) the competent authority.
- (b) When any or all VFR operations on and in the vicinity of an aerodrome are suspended, the aerodrome control tower shall observe the following procedures:

- (1) hold all VFR departures;
- (2) recall all local flights operating under VFR or obtain approval for special VFR operations;
- (3) notify the approach control unit or area control centre as appropriate of the action taken;
- (4) notify all operators, or their designated representatives, of the reason for taking such action, if necessary or requested.

GM1 ATS.TR.145 Suspension of visual flight rules operations on and in the vicinity of an aerodrome

ED Decision 2020/008/R

All such suspensions of VFR operations should be accomplished through or notified to the aerodrome control tower.

ATS.TR.150 Aeronautical ground lights

Commission Implementing Regulation (EU) 2020/469

An air traffic services provider shall establish procedures for the operation of aeronautical ground lights, whether or not they are on or in the vicinity of an aerodrome.

AMC1 ATS.TR.150 Aeronautical ground lights

ED Decision 2020/008/R

PROCEDURES FOR THE OPERATION OF AERONAUTICAL GROUND LIGHTS

- (a) Except as provided in point (b), all aeronautical ground lights should be operated:
 - (1) continuously during the hours of darkness or during the time the centre of the sun's disc is more than 6 degrees below the horizon, whichever requires the longer period of operation, unless otherwise provided hereafter or otherwise required for the control of air traffic; and
 - (2) at any other time when their use, based on meteorological conditions, is considered desirable for the safety of air traffic.
- (b) Lights on and in the vicinity of aerodromes that are not intended for en-route navigation purposes may be turned off, subject to further provisions hereafter, if no likelihood of either regular or emergency operation exists, provided that they can be again brought into operation at least one hour before the expected arrival of an aircraft.
- (c) At aerodromes equipped with lights of variable intensity, a table of intensity settings, based on conditions of visibility and ambient light, should be provided for the guidance of air traffic services personnel in effecting adjustment of these lights to suit the prevailing conditions. When so requested by an aircraft, further adjustment of the intensity should be made whenever possible.
- (d) In addition to point (a), approach lighting should also be operated:
 - (1) by day when requested by an approaching aircraft; and
 - (2) when the associated runway lighting is operated.

- (e) The lights of a visual approach slope indicator system should be operated during the hours of daylight as well as of darkness and irrespective of the visibility conditions when the associated runway is being used.
- (f) Runway lighting should not be operated if that runway is not in use for landing, take-off or taxiing purposes unless required for runway inspections or maintenance.
- (g) If runway lighting is not operated continuously, lighting following a take-off should be provided as specified below:
 - (1) at aerodromes where air traffic control service is provided and where lights are centrally controlled, the lights of one runway should remain lighted after take-off as long as is considered necessary for the return of the aircraft due to an emergency occurring during or immediately after take-off;
 - (2) at aerodromes without air traffic control service or without centrally controlled lights, the lights of one runway should remain lighted until such time as would normally be required to reactivate the lights in the likelihood of the departing aircraft returning for an emergency landing, and in any case not less than 15 minutes after take-off.
- (h) Stopway lights should be operated whenever the associated runway lights are operated.
- (i) Where required to provide taxi guidance, taxiway lighting should be turned on in such order that a continuous indication of the taxi path is presented to taxiing aircraft. Taxiway lighting or any portion thereof may be turned off when no longer needed.
- (j) Stop bars should be switched on to indicate that all traffic shall stop, and switched off to indicate that traffic may proceed.
- (k) Obstacle lighting associated with the approach to or departure from a runway or channel, where the obstacle does not project through the inner horizontal surface, as described in the applicable aerodrome design specifications, may be turned off and on simultaneously with the runway or channel lights.
- (l) Unserviceability lights should not be turned off as permitted under point (k) while the aerodrome is open.
- (m) ATS personnel should make use of automatic monitoring facilities, when provided, to ascertain whether the lighting is in good order and functioning according to selection.
- (n) In the absence of an automatic monitoring system or to supplement such a system, air traffic services personnel should visually observe such lighting as can be seen from the aerodrome control tower and use information from other sources such as visual inspections or reports from aircraft to maintain awareness of the operational status of the visual aids.
- (o) On receipt of information indicating a lighting fault, air traffic services personnel should take such action as is warranted to safeguard any affected aircraft or vehicles, and initiate action to have the fault rectified.

GM1 to AMC1 ATS.TR.150 Aeronautical ground lights

ED Decision 2020/008/R

OPERATION OF AERONAUTICAL GROUND LIGHTS

- (a) Approach lighting includes such lights as simple approach lighting systems, precision approach lighting systems, visual approach slope indicator systems, circling guidance lights, approach light beacons and runway alignment indicators.

- (b) Runway lighting includes such lights as edge, threshold, centre line, end, touchdown zone and wing bar lights.
- (c) Where obstacle lighting is operated simultaneously with runway lighting as provided in point (k) of [AMC1 ATS.TR.150](#), particular care should be taken to ensure that it is not turned off until no longer required by the aircraft.
- (d) Taxiway lighting includes such lights as edge lights, centre line lights, stop bars and clearance bars.
- (e) Stop bars, which are used exclusively when aerodrome control service is provided, are located across taxiways at the point where it is desired that traffic stop, and consist of lights, showing red, spaced across the taxiway.
- (f) Obstacle lighting includes such lights as obstacle and unserviceability lights and hazard beacons.

ATS.TR.155 ATS surveillance services

Commission Implementing Regulation (EU) 2020/469

- (a) An air traffic services provider may use ATS surveillance systems in the provision of air traffic services. In such case, the air traffic services provider shall specify the functions for which ATS surveillance information is used.
- (b) When providing ATS surveillance services, an air traffic services provider shall:
 - (1) ensure that the ATS surveillance system or systems in use provide for a continuously updated presentation of surveillance information, including position indications;
 - (2) when air traffic control service is provided:
 - (i) determine the number of aircraft simultaneously provided with ATS surveillance services which can be safely handled under the prevailing circumstances;
 - (ii) provide air traffic controllers at all times with full and up-to-date information regarding:
 - A. established minimum flight altitudes within the area of responsibility;
 - B. the lowest usable flight level or levels determined in accordance with points ATS.TR.130 and ATS.TR.135;
 - C. established minimum altitudes applicable to procedures based on tactical vectoring and direct routing, including the necessary temperature correction or method to correct the effect of low temperatures on minimum altitudes.
- (c) An air traffic services provider shall, in accordance with the functions for which ATS surveillance information is used in the provision of air traffic services, establish procedures for:
 - (1) establishing identification of aircraft;
 - (2) providing position information to aircraft;
 - (3) vectoring aircraft;
 - (4) providing navigation assistance to aircraft;
 - (5) providing information regarding adverse weather, if applicable;
 - (6) transferring of control of aircraft;

- (7) failure of ATS surveillance system or systems;
 - (8) SSR transponder failure, in accordance with the provisions of Section 13 of the Annex to Implementing Regulation (EU) No 923/2012;
 - (9) ATS surveillance-based safety-related alerts and warnings, when implemented;
 - (10) interruption or termination of ATS surveillance service.
- (d) Before providing an ATS surveillance service to an aircraft, identification shall be established and the pilot informed. Thereafter, identification shall be maintained until the termination of the ATS surveillance service. If identification is subsequently lost, the pilot shall be informed accordingly and, when applicable, appropriate instructions shall be issued.
- (e) When an identified controlled flight is observed to be on a conflicting path with an unknown aircraft, deemed to constitute a collision hazard, the pilot of the controlled flight shall, whenever practicable:
- (1) be informed of the unknown aircraft, and, if the pilot so requests or if the situation so warrants in the opinion of the controller, avoiding action shall be suggested; and
 - (2) be notified when the conflict no longer exists.
- (f) Unless otherwise prescribed by the competent authority, verification of the pressure-altitude-derived level information displayed shall be effected at least once by each suitably equipped air traffic services unit on initial contact with the aircraft concerned or, if this is not feasible, as soon as possible thereafter.
- (g) Only verified pressure-altitude-derived level information shall be used to determine that aircraft performed either of the following actions:
- (1) maintain a level;
 - (2) vacate a level;
 - (3) pass a level in climb or descent;
 - (4) reach a level.

GM1 ATS.TR.155 ATS surveillance services

ED Decision 2020/008/R

USE OF INFORMATION DERIVED FROM ATS SURVEILLANCE SYSTEMS FOR AIR TRAFFIC CONTROL SERVICE PURPOSES

Information derived from ATS surveillance systems, including safety-related alerts and warnings such as conflict alert and minimum safe altitude warning, should be used to the extent possible in the air traffic control service provision in order to improve capacity and efficiency as well as to enhance safety.

AMC1 ATS.TR.155(a) ATS surveillance services

ED Decision 2020/008/R

FUNCTIONS OF THE ATS SURVEILLANCE SYSTEMS IN AIR TRAFFIC SERVICES PROVISION

(a) Functions in the area control service and approach control service

The information provided by ATS surveillance systems and presented on a situation display may be used to perform one or more of the following functions in the provision of area control service or approach control service:

- (1) provide ATS surveillance services as necessary in order to improve airspace utilisation, reduce delays, provide for direct routings and more optimum flight profiles, as well as to enhance safety;
- (2) provide vectoring to departing aircraft for the purpose of facilitating an expeditious and efficient departure flow and expediting climb to cruising level;
- (3) provide vectoring to aircraft for the purpose of resolving potential conflicts;
- (4) provide vectoring to arriving aircraft for the purpose of establishing an expeditious and efficient approach sequence;
- (5) provide vectoring to assist pilots in their navigation, e.g. to or from a radio navigation aid, away from or around areas of adverse weather;
- (6) provide separation and maintain normal traffic flow when an aircraft experiences communication failure within the area of coverage;
- (7) maintain flight path monitoring of air traffic;
- (8) when applicable, maintain a watch on the progress of air traffic, in order to provide a procedural air traffic controller with:
 - (i) improved position information regarding aircraft under control;
 - (ii) supplementary information regarding other traffic; and
 - (iii) information regarding any significant deviations by aircraft from the terms of their respective ATC clearances, including their cleared routes as well as levels, when appropriate.

(b) Additional functions in the approach control service

In addition to the functions listed in point (a), the position indications presented on a situation display may be used to perform one or more of the following functions in the provision of approach control service:

- (1) provide vectoring of arriving traffic on to pilot-interpreted final approach aids;
- (2) provide flight path monitoring of parallel ILS approaches and instruct aircraft to take appropriate action in the event of possible or actual penetrations of the no transgression zone (NTZ);
- (3) provide vectoring of arriving traffic to a point from which a visual approach can be completed;
- (4) provide vectoring of arriving traffic to a point from which a surveillance radar approach can be made;
- (5) provide flight path monitoring of other pilot-interpreted instrument approach procedure;

- (6) in accordance with prescribed procedures, conduct surveillance radar approaches; and
- (7) provide separation between:
 - (i) succeeding departing aircraft;
 - (ii) succeeding arriving aircraft; and
 - (iii) a departing aircraft and a succeeding arriving aircraft.
- (c) Functions in the aerodrome control service
 - (1) When authorised and subject to procedures and conditions prescribed by the air traffic services provider, ATS surveillance systems may be used in the provision of aerodrome control service to perform the following functions:
 - (i) flight path monitoring of aircraft on final approach;
 - (ii) flight path monitoring of other aircraft in the vicinity of the aerodrome;
 - (iii) establishing an appropriate longitudinal and/or distance-based separation based on ATS surveillance systems in between succeeding departing aircraft;
 - (iv) maintaining separation between succeeding aircraft on the same final approach; and
 - (v) providing navigation assistance to VFR flights
 - (2) In prescribing conditions and procedures for the use of ATS surveillance systems in the provision of aerodrome control service, the air traffic services provider should ensure that the availability and use of an ATS surveillance system will not be detrimental to visual observation of aerodrome traffic.
- (d) Functions in the flight information service

The information presented on a situation display may be used to provide identified aircraft with information:

 - (1) regarding any aircraft observed to be on a conflicting path with the identified aircraft and suggestions or advice regarding avoiding action;
 - (2) on the position of significant weather and, as practicable, advice to the aircraft on how best to circumnavigate any such areas of adverse weather. When doing so, attention is to be paid to the fact that under certain circumstances the most active area of adverse weather may not be displayed; and
 - (3) to assist the aircraft in its navigation.

GM1 ATS.TR.155(a) ATS surveillance services

ED Decision 2020/008/R

ATS SURVEILLANCE SERVICES PROVISION IN PRESENCE OF CONTROLLED BUT UNIDENTIFIED AIRCRAFT

In the event that the air traffic controller has been notified of a controlled flight entering or about to enter the airspace within which a separation minimum based on ATS surveillance systems is applied, but has not identified the aircraft, the air traffic controller may, if so prescribed by the air traffic services provider, continue to provide ATS surveillance services to identified aircraft, provided that:

- (a) reasonable assurance exists that the unidentified controlled flight will be identified using SSR and/or ADS-B and/or MLAT or the flight is being operated by an aircraft of a type which may be

expected to give an adequate return on primary radar in the airspace within which the separation is applied; and

- (b) the separation is maintained between identified flights and any other observed ATS surveillance system position indications until either the unidentified controlled flight has been identified or procedural separation has been established.

GM1 ATS.TR.155(b)(1) ATS surveillance services

ED Decision 2020/008/R

ATS SURVEILLANCE SYSTEM — PERFORMANCE CHECKS

- (a) The air traffic controller, FIS officer, and AFIS officer that utilise ATS surveillance systems should adjust the situation display(s) and carry out adequate checks on the accuracy thereof, in accordance with the technical instructions prescribed by the air traffic services provider.
- (b) The air traffic controller, FIS officer, and AFIS officer that utilise ATS surveillance systems should be satisfied that the available functional capabilities of the ATS surveillance system as well as the information presented on the situation display(s) are adequate for the functions to be performed.

GM2 ATS.TR.155(b)(1) ATS surveillance services

ED Decision 2020/008/R

ATS SURVEILLANCE SYSTEM — PERFORMANCE REQUIREMENTS

Performance requirements for ATS surveillance systems and their constituents are specified in Regulation (EU) No 1207/2011.

AMC1 ATS.TR.155(b)(2)(i) ATS surveillance services

ED Decision 2020/008/R

FACTORS DETERMINING THE NUMBER OF AIRCRAFT SIMULTANEOUSLY PROVIDED WITH AIR TRAFFIC CONTROL SERVICE USING ATS SURVEILLANCE SYSTEMS

When determining the number of aircraft simultaneously provided with ATS surveillance services, the air traffic services provider should take into account, as a minimum:

- (a) the structural complexity of the control area or sector concerned;
- (b) the functions to be performed within the control area or sector concerned;
- (c) assessments of air traffic controller workloads, taking into account different aircraft capabilities, and sector capacity; and
- (d) the degree of technical reliability and availability of the primary and backup communications, navigation and surveillance systems, both in the aircraft and on the ground.

AMC1 ATS.TR.155(c)(1) ATS surveillance services

ED Decision 2020/008/R

METHODS OF IDENTIFICATION

Identification of aircraft should be established by at least one of the following methods:

- (a) ADS-B identification procedures

Where ADS-B is used for identification, aircraft may be identified by one or more of the following procedures:

- (1) direct recognition of the aircraft identification in an ADS-B label;
 - (2) transfer of ADS-B identification; and
 - (3) observation of compliance with an instruction to 'TRANSMIT ADS-B IDENT'.
- (b) SSR and/or MLAT identification procedures
- (1) Where SSR and/or MLAT is used for identification, aircraft may be identified by one or more of the following procedures:
 - (i) recognition of the aircraft identification in an SSR and/or MLAT label, in accordance with Article 4 of Regulation (EU) No 1206/2011;
 - (ii) recognition of an assigned discrete code, the setting of which has been verified, in an SSR and/or MLAT label, in accordance with Article 4 of Regulation (EU) No 1206/2011;
 - (iii) direct recognition of the aircraft identification of a Mode S-equipped aircraft in an SSR and/or MLAT label, in accordance with Article 4 of Regulation (EU) No 1206/2011;
 - (iv) by transfer of identification;
 - (v) observation of compliance with an instruction to set a specific code; and
 - (vi) observation of compliance with an instruction to squawk 'IDENT'.
 - (2) When a discrete code has been assigned to an aircraft, a check should be made at the earliest opportunity to ensure that the code set by the pilot is identical to that assigned for the flight. Only after this check has been made, the discrete code should be used as a basis for identification.
- (c) PSR identification procedures
- (1) Where PSR is used for identification, aircraft may be identified by one or more of the following procedures:
 - (i) by correlating a particular radar position indication with an aircraft reporting its position over, or as bearing and distance from, a point shown on the situation display, and by ascertaining that the track of the particular radar position is consistent with the aircraft path or reported heading;
 - (ii) by correlating an observed radar position indication with an aircraft which is known to have just departed, provided that the identification is established within 2 km (1 NM) from the end of the runway used. Particular care should be taken to avoid confusion with aircraft holding over or overflying the aerodrome, or with aircraft departing from or making a missed approach over adjacent runways;
 - (iii) by transfer of identification;
 - (iv) when air traffic control service is provided, by ascertaining the aircraft heading, if circumstances require, and following a period of track observation:
 - (A) instructing the pilot to execute one or more changes of heading of 30 degrees or more and correlating the movements of one particular radar

- position indication with the aircraft's acknowledged execution of the instructions given; or
- (B) correlating the movements of a particular radar position indication with manoeuvres currently executed by an aircraft having so reported.
- (2) When using these methods, the air traffic controller/FIS officer/AFIS officer, as appropriate, should:
- (i) verify that the movements of not more than one radar position indication correspond with those of the aircraft; and
 - (ii) ensure that the manoeuvre(s) will not carry the aircraft outside the coverage of the radar or the situation display.
- (d) Additional identification method
- When two or more position indications are observed in close proximity, or are observed to be making similar movements at the same time, or when doubt exists as to the identity of a position indication for any other reason, the identification procedure in point (c)(1)(iv) should be used (only in case of air traffic control service provision), or additional methods of identification should be employed, until all risk of error in identification is eliminated.

AMC2 ATS.TR.155(c)(1) ATS surveillance services

ED Decision 2020/008/R

METHODS OF IDENTIFICATION — USE OF ATS SURVEILLANCE SYSTEMS IN SURFACE MOVEMENT CONTROL OR MANAGEMENT

Where an ATS surveillance system is used in surface movement control or management, the air traffic controller/AFIS officer may identify aircraft by one or more of the following procedures:

- (a) correlating a particular position indication with an:
 - (1) aircraft position visually observed by the air traffic controller/AFIS officer; or
 - (2) aircraft position reported by the pilot; or
 - (3) identified position indication displayed on a situation display;
- (b) transfer of identification when authorised by the competent authority; and
- (c) automated identification procedures when authorised by the competent authority.

AMC3 ATS.TR.155(c)(1) ATS surveillance services

ED Decision 2020/008/R

METHODS OF IDENTIFICATION — TRANSFER OF IDENTIFICATION

- (a) Transfer of identification from one air traffic controller/FIS officer/AFIS officer to another should only be attempted when it is considered that the aircraft is within the accepting air traffic controller's/FIS officer's/AFIS officer's surveillance coverage.
- (b) Transfer of identification should be effected by one of the following methods:
 - (1) designation of the position indication by automated means, provided that only one position indication is thereby indicated and there is no possible doubt of correct identification;

- (2) notification of the aircraft's discrete SSR code;
- (3) notification of the automated or system-to-system aircraft address;
- (4) notification that the aircraft is SSR Mode S-equipped with an aircraft identification feature when SSR Mode S coverage is available;
- (5) notification that the aircraft is ADS-B-equipped with an aircraft identification feature when compatible ADS-B coverage is available;
- (6) direct designation (pointing with the finger) of the position indication if the two situation displays are adjacent or if a common 'conference' type of situation display is used;
- (7) designation of the position indication by reference to, or in terms of bearing and distance from, a geographical position or navigational facility accurately indicated on both situation displays, together with the track of the observed position indication if the route of the aircraft is not known to both air traffic controllers/FIS officers/AFIS officers;
- (8) where applicable, issuance of an instruction to the aircraft by the transferring air traffic controller/FIS officer/AFIS officer to change SSR code and the observation of the change by the accepting air traffic controller/FIS officer/AFIS officer; or
- (9) issuance of an instruction to the aircraft by the transferring air traffic controller/FIS officer/AFIS officer to squawk/transmit IDENT and observation of this response by the accepting air traffic controller/FIS officer/AFIS officer.

GM1 to AMC3 ATS.TR.155(c)(1) ATS surveillance services

ED Decision 2020/008/R

METHODS OF IDENTIFICATION — TRANSFER OF IDENTIFICATION

- (a) When applying the identification method described in point (b)(6) of [AMC3 ATS.TR.155\(c\)\(1\)](#), attention is to be paid to any errors which might occur due to parallax effects.
- (b) When applying the identification method described in point (b)(7) of AMC3 ATS.TR.155(c)(1), caution is to be exercised before transferring identification using this method, particularly if other position indications are observed on similar headings and in close proximity to the aircraft to which air traffic services are provided. Inherent radar deficiencies, such as inaccuracies in bearing and distance of the radar position indications displayed on individual situation displays and parallax errors, may cause the indicated position of an aircraft in relation to the known point to differ between the two situation displays. The air traffic services provider may therefore prescribe additional conditions for the application of this method, e.g.:
 - (1) a maximum distance from the common reference point used by the affected air traffic controller(s)/FIS officer(s)/AFIS officer(s), as applicable; and
 - (2) a maximum distance between the position indication as observed by the accepting air traffic controller/FIS officer/AFIS officer and the one stated by the transferring air traffic controller/FIS officer/AFIS officer.
- (c) The use of procedures in points (b)(8) and (b)(9) of AMC3 ATS.TR.155(c)(1) requires prior coordination between the air traffic controllers/FIS officers/AFIS officers, since the indications to be observed by the accepting air traffic controller/FIS officer/AFIS officer are of short duration.

GM1 ATS.TR.155(c)(1) ATS surveillance services

ED Decision 2020/008/R

METHODS OF IDENTIFICATION — SSR AND/OR MLAT IDENTIFICATION PROCEDURES

When applying this method of identification, the air traffic controller/FIS officer/AFIS officer should consider that some aircraft equipped with first generation ADS-B avionics do not have the capability of squawking IDENT while the emergency and/or urgency mode is selected.

GM2 ATS.TR.155(c)(1) ATS surveillance services

ED Decision 2020/008/R

METHODS OF IDENTIFICATION — PSR IDENTIFICATION PROCEDURE

- (a) Caution is to be exercised when employing this method since a position reported in relation to a point may not coincide precisely with the radar position indication of the aircraft on the situation display. The air traffic services provider may, therefore, prescribe additional conditions for the application of this method, e.g.
- (1) a level or levels above which this method may not be applied in respect of specified navigation aids; or
 - (2) a distance from the radar site beyond which this method may not be applied.
- (b) The term ‘a point’ refers to a geographical point suitable for the purposes of identification. It is normally a reporting point defined by reference to a radio navigation aid or aids.

AMC1 ATS.TR.155(c)(2) ATS surveillance services

ED Decision 2020/008/R

POSITION INFORMATION

- (a) An aircraft provided with ATS surveillance services should be informed of its position in the following circumstances:
- (1) upon identification, except when the identification is established:
 - (i) based on the pilot’s report of the aircraft position or within one nautical mile of the runway upon departure and the observed position on the situation display is consistent with the aircraft’s time of departure; or
 - (ii) by use of ADS-B aircraft identification, Mode S aircraft identification or assigned discrete SSR codes and the location of the observed position indication is consistent with the current flight plan of the aircraft; or
 - (iii) by transfer of identification;
 - (2) when the pilot requests this information;
 - (3) when a pilot’s estimate differs significantly from the air traffic controller’s estimate based on the observed position;
 - (4) unless otherwise prescribed by the competent authority, when the pilot is instructed by the air traffic controller to resume own navigation after vectoring if the current instructions had diverted the aircraft from a previously assigned route; and
 - (5) when air traffic control service is provided, immediately before termination of ATS surveillance services if the aircraft is observed to deviate from its intended route.

- (b) Position information should be passed on to aircraft in one of the following forms:
- (1) as a well-known geographical position;
 - (2) magnetic track and distance to a significant point, an en-route navigation aid, or an approach aid;
 - (3) direction (using points of the compass) and distance from a known position;
 - (4) distance to touchdown if the aircraft is on final approach; or
 - (5) distance and direction from the centre line of an ATS route.
- (c) Whenever practicable, position information should relate to positions or routes pertinent to the navigation of the aircraft concerned and shown on the situation display map.

AMC1 ATS.TR.155(c)(3) ATS surveillance services

ED Decision 2020/008/R

VECTORING INSTRUCTIONS IN AIR TRAFFIC CONTROL SERVICE PROVISION — GENERAL

- (a) When vectoring an aircraft, an air traffic controller should comply with the following:
- (1) when an aircraft is given its initial vector diverting it from a previously assigned route, the pilot should be informed what the vector is to accomplish, and, the limit of the vector should be specified when the assigned heading is such that a loss of communications may result in a safety risk (e.g. to ... position, for ... approach);
 - (2) except when transfer of control is to be effected, aircraft should not be vectored closer than 4.6 km (2.5 NM) or, where the minimum permissible separation is greater than 9.3 km (5 NM), a distance equivalent to one-half of the prescribed separation minimum, from the limit of the airspace for which the air traffic controller is responsible, unless local arrangements have been made to ensure that separation will exist with aircraft operating in adjoining areas;
 - (3) controlled flights should not be vectored into uncontrolled airspace except in the case of emergency or in order to circumnavigate adverse meteorological conditions (in which case the pilot should be so informed), or at the specific request of the pilot; and
 - (4) when an aircraft has reported unreliable directional instruments, the pilot should be requested, prior to the issuance of manoeuvring instructions, to make all turns at an agreed rate and to carry out the instructions immediately upon receipt.
- (b) Special VFR flights should not be vectored unless special circumstances, such as emergencies, dictate otherwise.
- (c) In terminating vectoring of an aircraft, the air traffic controller should instruct the pilot to resume own navigation, giving the pilot the aircraft's position and appropriate instructions, as necessary, in the form prescribed in point (b)(2) of [AMC1 ATS.TR.155\(c\)\(2\)](#), if the current instructions had diverted the aircraft from a previously assigned route.

GM1 to AMC1 ATS.TR.155(c)(3) ATS surveillance services

ED Decision 2020/008/R

VECTORING INSTRUCTIONS IN AIR TRAFFIC CONTROL SERVICE PROVISION — GENERAL

- (a) Vectoring is achieved by issuing to the pilot specific headings which will enable the aircraft to maintain the desired track.
- (b) Whenever practicable, air traffic controllers should vector aircraft along tracks on which the pilot can monitor the aircraft position with reference to pilot-interpreted navigation aids; this will minimise the amount of navigational assistance required and alleviate the consequences resulting from an ATS surveillance system failure.
- (c) Air traffic controllers should exercise caution when vectoring VFR flights so as to ensure that the aircraft concerned does not inadvertently enter instrument meteorological conditions (IMC).

GM2 to AMC1 ATS.TR.155(c)(3) ATS surveillance services

ED Decision 2020/008/R

VECTORING INSTRUCTIONS IN AIR TRAFFIC CONTROL SERVICE PROVISION — GENERAL

With reference to point (a)(2) of [AMC1 ATS.TR.155\(c\)\(3\)](#): the establishment of a limit of the airspace beyond which aircraft should not be vectored is to ensure that the prescribed separation minimum is achieved between controlled flights within adjoining volumes of controlled airspace without the need to effect coordination. Where a volume of controlled airspace is adjacent to uncontrolled airspace, there is no requirement to apply such a limit. However, competent authorities may set a limit beyond which aircraft should not be vectored in order to mitigate the risk of collision resulting from airspace infringement and the likelihood of ACAS nuisance alerting against aircraft operating close to the airspace boundary in uncontrolled airspace.

GM3 to AMC1 ATS.TR.155(c)(3) ATS surveillance services

ED Decision 2020/008/R

VECTORING INSTRUCTIONS IN AIR TRAFFIC CONTROL SERVICE PROVISION — GENERAL

- (a) With reference to point (a)(2) of [AMC1 ATS.TR.155\(c\)\(3\)](#): When a controlled flight has been vectored into uncontrolled airspace in an emergency or in order to circumnavigate adverse meteorological conditions, air traffic controllers may provide advice or issue clearances to the extent necessary to:
 - (1) assist the aircraft in a state of emergency; or
 - (2) to permit the aircraft to rejoin controlled airspace once clear of the adverse meteorological conditions.
- (b) When an aircraft has been cleared to follow own navigation or accepts a vector in order to avoid adverse meteorological conditions, it should be requested to report when able to return its current flight plan.

AMC2 ATS.TR.155(c)(3) ATS surveillance services

ED Decision 2020/008/R

VECTORIZING FOR APPROACH CONTROL

- (a) Prior to, or upon commencement of, vectoring for approach, the air traffic controller should advise the pilot of the type of approach as well as the runway to be used.
- (b) The air traffic controller should advise the pilot of an aircraft being vectored for an instrument approach of its position at least once prior to commencement of final approach.
- (c) When giving distance information, the air traffic controller should specify the point or navigation aid to which the information refers.
- (d) Aircraft vectored for final approach should be given a heading or a series of headings calculated to close with the final approach track. The final vector should enable the aircraft to be established on the final approach track prior to intercepting the specified or nominal glide path of the approach procedure from below, and should provide an intercept angle with the final approach track of 45 degrees or less.
- (e) Whenever an aircraft is assigned a vector which will take it through the final approach track, it should be advised accordingly, stating the reason for the vector.
- (f) When an aircraft is vectored to a pilot-interpreted final approach aid:
 - (1) the aircraft should be instructed to report when established on the final approach track;
 - (2) the transfer of communications to the aerodrome air traffic controller should be effected at such a point or time that clearance to land or alternative instructions can be issued to the aircraft in a timely manner.
- (g) When an aircraft is vectored for visual approach:
 - (1) the reported ceiling is to be above the minimum altitude applicable to vectoring and meteorological conditions such that, with reasonable assurance, a visual approach and landing can be completed; and
 - (2) clearance for visual approach is to be issued after the pilot has reported the aerodrome or the preceding aircraft in sight, at which time vectoring would normally be terminated.

GM1 to AMC2 ATS.TR.155(c)(3) ATS surveillance services

ED Decision 2020/008/R

VECTORIZING TO PILOT-INTERPRETED FINAL APPROACH AIDS

- (a) The air traffic controller should issue the clearance for the approach prior to the time the aircraft reports are established unless circumstances preclude the issuance of the clearance at such time. Vectoring will normally terminate at the time the aircraft leaves the last assigned heading to intercept the final approach track.
- (b) When clearance for the approach is issued, the aircraft is expected to maintain the last assigned level until intercepting the specified or nominal glide path of the approach procedure. If the air traffic controller requires an aircraft to intercept the glide path at a level other than a level flight segment depicted on the instrument approach chart, the air traffic controller should instruct the pilot to maintain the particular level until established on the glide path.
- (c) The approach air traffic controller is normally responsible for maintaining separation based on ATS surveillance systems between succeeding aircraft on the same final approach, except that

the responsibility may be transferred to the aerodrome air traffic controller in accordance with procedures prescribed by the air traffic services provider, and provided an ATS surveillance system is available to the aerodrome air traffic controller.

GM2 to AMC2 ATS.TR.155(c)(3) ATS surveillance services

ED Decision 2020/008/R

PROCEDURES FOR RADAR APPROACHES

- (a) During the period that an air traffic controller is engaged in giving surveillance radar approaches, he or she should not be responsible for any duties other than those directly connected with such approaches.
- (b) Air traffic controllers conducting radar approaches should be provided with information regarding the OCAs/OCHs established for the types of approach to be conducted.
- (c) Prior to commencement of a radar approach, the air traffic controller should inform the aircraft of the:
 - (1) runway to be used;
 - (2) applicable OCA/OCH;
 - (3) angle of the nominal glide path and the approximate rate of descent to be maintained; and
 - (4) procedure to be followed in the event of radio communication failure unless the procedure has been published in AIPs.
- (d) When a radar approach cannot be continued due to any circumstance, the aircraft should be immediately informed that a radar approach or continuation thereof is not possible. The approach should be continued if this is possible using non-radar facilities or if the pilot reports that the approach can be completed visually; otherwise, an alternative clearance should be given.
- (e) Aircraft making a radar approach should be reminded, when on final approach, to check that the wheels are down and locked.
- (f) Unless otherwise prescribed by the air traffic services provider, the air traffic controller conducting the approach should notify the aerodrome air traffic controller or, when applicable, the procedural air traffic controller when an aircraft making a radar approach is approximately 15 km (8 NM) from touchdown. If landing clearance is not received at this time, a subsequent notification should be made at approximately 8 km (4 NM) from touchdown and landing clearance requested.
- (g) Clearance to land or any alternative clearance received from the aerodrome air traffic controller or, when applicable, the procedural air traffic controller should normally be passed on to the aircraft before it reaches a distance of 4 km (2 NM) from touchdown.
- (h) An aircraft making a radar approach should:
 - (1) be directed to execute a missed approach in the following circumstances:
 - (i) when the aircraft appears to be dangerously positioned on final approach; or
 - (ii) for reasons involving traffic conflicts; or

- (iii) if no clearance to land has been received from the procedural air traffic controller by the time the aircraft reaches a distance of 4 km (2 NM) from touchdown or such other distance as has been agreed with the aerodrome control tower; or
 - (iv) on instructions by the aerodrome air traffic controller;
- or
- (2) be advised to consider executing a missed approach in the following circumstances:
 - (i) when the aircraft reaches a position from which it appears that a successful approach cannot be completed; or
 - (ii) if the aircraft is not visible on the situation display for any significant interval during the last 4 km (2 NM) of the approach; or
 - (iii) if the position or identification of the aircraft is in doubt during any portion of the final approach.

In all such cases, the reason for the instruction or the advice should be given to the pilot.

- (i) Unless otherwise required by exceptional circumstances, radar instructions concerning a missed approach should be in accordance with the prescribed missed approach procedure and should include the level to which the aircraft is to climb and heading instructions to keep the aircraft within the missed approach area during the missed approach procedure.

GM3 to AMC2 ATS.TR.155(c)(3) ATS surveillance services

ED Decision 2020/008/R

FINAL APPROACH PROCEDURES — SURVEILLANCE RADAR APPROACH

- (a) A surveillance radar approach should only be performed with equipment suitably sited and a situation display specifically marked to provide information on position relative to the extended centre line of the runway to be used and distance from touchdown, and which is specifically approved for the purpose by the competent authority.
- (b) When conducting a surveillance radar approach, the air traffic controller should comply with the following:
 - (1) at or before the commencement of the final approach, the aircraft should be informed of the point at which the surveillance radar approach will be terminated;
 - (2) the aircraft should be informed when it is approaching the point at which it is computed that descent should begin, and just before reaching that point it should be informed of the OCA/OCH and instructed to descend and check the applicable minima;
 - (3) azimuth instructions should be given as follows:
 - (i) the pilot should be informed at regular intervals of the aircraft's position in relation to the extended centre line of the runway. Heading corrections should be given as necessary to bring the aircraft back on to the extended centre line;
 - (ii) in the case of azimuth deviations, the pilot should not take corrective action unless specifically instructed to do so;
 - (4) except as provided in point (c), information on distance from touchdown should normally be passed on at every 2 km (each NM);

- (5) pre-computed levels through which the aircraft should be passing to maintain the glide path should also be transmitted at every 2 km (each NM) at the same time as the distance; and
- (6) the surveillance radar approach should be terminated:
 - (i) at a distance of 4 km (2 NM) from touchdown, except as provided in point (c); or
 - (ii) before the aircraft enters an area of continuous radar clutter; or
 - (iii) when the pilot reports that a visual approach can be effected, whichever is the earliest.
- (c) When, as determined by the competent authority, the accuracy of the radar equipment permits, surveillance radar approaches may be continued to the threshold of the runway, or to a prescribed point less than 4 km (2 NM) from touchdown, in which case:
 - (1) distance and level information should be given at each km (each half NM);
 - (2) transmission should not be interrupted for intervals of more than 5 seconds while the aircraft is within a distance of 8 km (4 NM) from touchdown; and
 - (3) the air traffic controller should not be responsible for any duties other than those directly connected with a particular approach.
- (d) Levels through which the aircraft should pass to maintain the required glide path, and the associated distances from touchdown, should be pre-computed and displayed in such a manner as to be readily available to the air traffic controller concerned.

GM1 ATS.TR.155(c)(3) ATS surveillance services

ED Decision 2020/008/R

VECTORING — DEFINITION OF INITIAL AND INTERMEDIATE APPROACH PHASES

The initial and intermediate approach phases of an approach executed under the direction of an air traffic controller comprise those parts of the approach from the time vectoring is initiated for the purpose of positioning the aircraft for a final approach until the aircraft is on final approach and:

- (a) established on the final approach path of a pilot-interpreted aid; or
- (b) reports that it is able to complete a visual approach; or
- (c) ready to commence a surveillance radar approach.

AMC1 ATS.TR.155(c)(4) ATS surveillance services

ED Decision 2020/008/R

NAVIGATION ASSISTANCE

An identified aircraft observed to deviate significantly from its intended route or designated holding pattern should be advised accordingly. Appropriate action should also be taken if, in the opinion of the air traffic controller such deviation is likely to affect the service being provided.

GM1 ATS.TR.155(c)(5) ATS surveillance services

ED Decision 2020/008/R

INFORMATION REGARDING ADVERSE WEATHER

- (a) Information that an aircraft appears likely to penetrate an area of adverse weather should be issued in sufficient time to permit the pilot to decide on an appropriate course of action, including that of requesting advice on how best to circumnavigate the adverse weather area, if so desired.
- (b) Depending on the capabilities of the ATS surveillance system, areas of adverse weather may not be presented on the situation display. An aircraft's weather radar will normally provide better detection and definition of adverse weather than radar sensors in use by air traffic services.
- (c) In vectoring an aircraft for circumnavigating any area of adverse weather, the air traffic controller should ascertain that the aircraft can be returned to its intended or assigned flight path within the coverage of the ATS surveillance system and, if this does not appear possible, inform the pilot of the circumstances.

AMC1 ATS.TR.155(c)(6) ATS surveillance services

ED Decision 2020/008/R

ATS SURVEILLANCE SERVICES — PROCEDURES FOR TRANSFER OF CONTROL

- (a) Where ATS surveillance services are being provided, transfer of control should be effected, whenever practicable, so as to enable the uninterrupted provision of ATS surveillance services.
- (b) Where SSR and/or ADS-B and/or MLAT is (are) used and the display of position indications with associated labels is provided for, transfer of control of aircraft between adjacent control positions or between adjacent air traffic control units may be effected without prior coordination, provided that:
 - (1) updated flight plan information on the aircraft about to be transferred, including the discrete assigned SSR code or, with respect to Mode S and ADS-B, the aircraft identification, is provided to the accepting air traffic controller prior to transfer;
 - (2) the ATS surveillance system coverage provided to the accepting air traffic controller is such that the aircraft concerned is presented on the situation display before the transfer is effected and is identified on, but preferably before, receipt of the initial call;
 - (3) when the air traffic controllers are not physically adjacent, two-way direct-speech facilities, which permit communications to be established instantaneously, are available between them at all times;
 - (4) the transfer point or points and all other conditions of application, such as direction of flight, specified levels, transfer of communication points, and especially an agreed minimum separation between aircraft, including that applicable to succeeding aircraft on the same route, about to be transferred as observed on the situation display, have been made the subject of specific instructions (for intra-unit transfer) or of a specific letter of agreement between two adjacent air traffic control units;
 - (5) the instructions or letter of agreement specify explicitly that the application of this type of transfer of control may be terminated at any time by the accepting air traffic controller, normally with an agreed advance notice; and

- (6) the accepting air traffic controller is informed of any level, speed or vectoring instructions given to the aircraft prior to its transfer and which modify its anticipated flight progress at the point of transfer.
- (c) The minimum agreed separation between aircraft about to be transferred (see point (b)(4)) and the advance notice (see point (b)(5)) should be determined taking into account all relevant technical, operational and other circumstances. If circumstances arise in which these agreed conditions can no longer be satisfied, air traffic controllers should revert to the procedure in point (d) until the situation is resolved.
- (d) Where primary radar is being used, and where another type of ATS surveillance system is employed but the provisions in point (b) are not applied, the transfer of control of aircraft between adjacent control positions or between two adjacent air traffic services units may be effected, provided that:
 - (1) identification has been transferred to or has been established directly by the accepting air traffic controller;
 - (2) when the air traffic controllers are not physically adjacent, two-way direct-speech facilities which permit communications to be established instantaneously between them are available at all times;
 - (3) separation from other controlled flights conforms to the minima authorised for use during transfer of control between the sectors or units concerned;
 - (4) the accepting air traffic controller is informed of any level, speed or vectoring instructions applicable to the aircraft at the point of transfer; and
 - (5) radio communication with the aircraft is retained by the transferring air traffic controller until the accepting air traffic controller has agreed to assume responsibility for providing the ATS surveillance services to the aircraft. Thereafter, the aircraft should be instructed to change over to the appropriate channel, and from that point the responsibility is that of the accepting air traffic controller.

GM1 to AMC1 ATS.TR.155(c)(6) ATS surveillance services

ED Decision 2020/008/R

ATS SURVEILLANCE SERVICES — PROCEDURES FOR TRANSFER OF CONTROL

Transfer of control based on the procedures specified in [AMC1 ATS.TR.155\(c\)\(6\)](#) may be carried out without systematic use of the bidirectional speech facilities available between the adjacent units concerned, provided that:

- (a) the detailed conditions applicable for the transfer are the subject of a bilateral agreement; and
- (b) the minimum distance between successive aircraft during the period of transfer is agreed as one of the following values:
 - (1) 19 km (10 NM) when SSR information is used in accordance with the provisions of AMC1 ATS.TR.155(c)(6), provided that an overlapping radar coverage of at least 56 km (30 NM) between units involved exists; or
 - (2) 9.3 km (5 NM) when the conditions of point (b)(1) apply and both units involved possess electronic aids for immediate recognition of release and acceptance of aircraft under radar transfer.

GM1 ATS.TR.155(c)(6) ATS surveillance services

ED Decision 2020/008/R

PROCEDURES FOR TRANSFER OF CONTROL IN ATS SURVEILLANCE SERVICES

Guidance on procedures for transfer of control in the ATS surveillance services provision may be found in the EUROCONTROL document titled 'Guidelines for the Application of European Coordination and Transfer Procedures' Edition 1.0 of 25 October 2012, which is available at: <https://www.eurocontrol.int/publication/guidelines-application-european-coordination-and-transfer-procedures>

GM1 ATS.TR.155(c)(7) ATS surveillance services

ED Decision 2020/008/R

PROCEDURES FOR AIR TRAFFIC CONTROL SERVICE IN CASE OF ATS SURVEILLANCE SYSTEM FAILURE

In the event of complete failure of the ATS surveillance system, where air-ground communications remain, the air traffic controllers should plot the positions of all aircraft already identified, take the necessary action to establish procedural separation between the aircraft and, if necessary, limit the number of aircraft permitted to enter the area.

GM2 ATS.TR.155(c)(7) ATS surveillance services

ED Decision 2020/008/R

SEPARATION APPLICATION IN CASE OF ATS SURVEILLANCE SYSTEM FAILURE

As an emergency measure, in the event of complete failure of the ATS surveillance system, where air-ground communications remain, the use of flight levels spaced by half the applicable vertical separation minimum may be resorted to temporarily if standard procedural separation cannot be provided immediately.

GM3 ATS.TR.155(c)(7) ATS surveillance services

ED Decision 2020/008/R

ATS SURVEILLANCE SYSTEM FAILURE — DATA DEGRADATION

In order to reduce the impact of a degradation of aircraft position source data (for example, a receiver autonomous integrity monitoring (RAIM) outage for GNSS), the air traffic services provider should establish contingency procedures to be followed by air traffic services units in the event of data degradation.

GM1 ATS.TR.155(c)(9) ATS surveillance services

ED Decision 2020/008/R

DISPLAY OF ATS SURVEILLANCE-BASED SAFETY-RELATED ALERTS AND WARNINGS

ATS surveillance systems should provide for the display of safety-related alerts and warnings, including conflict alert, conflict prediction, minimum safe altitude warning and unintentionally duplicated SSR codes and aircraft identification.

GM2 ATS.TR.155(c)(9) ATS surveillance services

ED Decision 2020/008/R

SHORT-TERM CONFLICT ALERT (STCA) PROCEDURES

The generation of STCAs is a function based on surveillance data, integrated into an air traffic control system. The objective of the STCA function is to assist the air traffic controller in preventing collision between aircraft by generating, in a timely manner, an alert of a potential or actual infringement of separation minima. Procedures and related instructions concerning the use of the STCA function should specify, inter alia:

- (a) the types of flight which are eligible for generation of alerts;
- (b) the sectors or areas of airspace within which the STCA function is implemented;
- (c) the method of displaying the STCA to the air traffic controller;
- (d) in general terms, the parameters for generation of alerts as well as alert warning time;
- (e) the volumes of airspace within which STCA can be selectively inhibited and the conditions under which this will be permitted;
- (f) conditions under which specific alerts may be inhibited for individual flights; and
- (g) procedures applicable in respect of volume of airspace or flights for which STCA or specific alerts have been inhibited.

GM3 ATS.TR.155(c)(9) ATS surveillance services

ED Decision 2020/008/R

MINIMUM SAFE ALTITUDE WARNING (MSAW) PROCEDURES

The generation of MSAWs is a function of an ATS surveillance data-processing system. The objective of the MSAW function is to assist in the prevention of controlled flight into terrain accidents by generating, in a timely manner, a warning of the possible infringement of a minimum safe altitude. Procedures and related instructions concerning the use of the MSAW function should specify, inter alia:

- (a) the types of flight which are eligible for generation of MSAW;
- (b) the sectors or areas of airspace for which MSAW minimum safe altitudes have been defined and within which the MSAW function is implemented;
- (c) the values of the defined MSAW minimum safe altitudes;
- (d) the method of displaying the MSAW to the air traffic controller;
- (e) the parameters for generation of a MSAW as well as warning time; and
- (f) conditions under which the MSAW function may be inhibited for individual aircraft tracks as well as procedures applicable in respect of flights for which MSAW has been inhibited.

AMC1 ATS.TR.155(c)(10) ATS surveillance services

ED Decision 2020/008/R

INTERRUPTION OR TERMINATION OF ATS SURVEILLANCE SERVICES

An aircraft which has previously been informed that it is provided with an ATS surveillance service should immediately be informed when, for any reason, the service is interrupted or terminated.

AMC1 ATS.TR.155(e) ATS surveillance services

ED Decision 2020/008/R

INFORMATION REGARDING TRAFFIC ON A CONFLICTING PATH

- (a) Information regarding traffic on a conflicting path should be given, whenever practicable, in the following form:
- (1) relative bearing of the conflicting traffic in terms of the 12-hour clock;
 - (2) distance from the conflicting traffic in kilometres or nautical miles;
 - (3) direction in which the conflicting traffic appears to be proceeding; and
 - (4) level and type of aircraft or, if unknown, relative speed of the conflicting traffic, e.g. slow or fast.
- (b) Pressure-altitude-derived level information, even when unverified, should be used in the provision of collision hazard information because such information, particularly if available from an otherwise unknown aircraft (e.g. a VFR flight) and given to the pilot of a known aircraft, could facilitate the location of a collision hazard.
- (c) If the level information has not been verified, the accuracy of the information should be considered uncertain and the pilot should be informed accordingly.

GM1 to AMC1 ATS.TR.155(e) ATS surveillance services

ED Decision 2020/008/R

INFORMATION REGARDING TRAFFIC ON A CONFLICTING PATH

With reference to point (a)(1) of [AMC1 ATS.TR.155\(e\)](#): In cases where using the terms of the 12-hour clock is not practicable, like when the aircraft is turning, the direction of the unknown aircraft may be given by compass points, e.g. northwest, south, etc.

GM2 to AMC1 ATS.TR.155(e) ATS surveillance services

ED Decision 2020/008/R

INFORMATION REGARDING TRAFFIC ON A CONFLICTING PATH

With reference to point (a)(4) of [AMC1 ATS.TR.155\(e\)](#): The level may be described either as a flight level, altitude or height, or as a relative vertical distance from the aircraft provided with traffic information (e.g. 1 000 ft above or 1 000 ft below).

AMC1 ATS.TR.155(f) ATS surveillance services

ED Decision 2020/008/R

TOLERANCE VALUE FOR PRESSURE-ALTITUDE-DERIVED LEVEL INFORMATION

The tolerance value used to determine that the pressure-altitude-derived level information displayed to the air traffic controller is accurate should be ± 60 m (± 200 ft) in RVSM airspace. In other airspace, it should be ± 90 m (± 300 ft), except that the competent authority may specify a smaller criterion, but not less than ± 60 m (± 200 ft), if this is found to be more practical.

AMC2 ATS.TR.155(f) ATS surveillance services

ED Decision 2020/008/R

VERIFICATION OF PRESSURE-ALTITUDE-DERIVED LEVEL INFORMATION

The verification should be effected by simultaneous comparison with altimeter-derived level information received from the same aircraft by radiotelephony. Geometric height information should not be used to determine if altitude differences exist.

GM1 ATS.TR.155(f) ATS surveillance services

ED Decision 2020/008/R

ERRONEOUS LEVEL INFORMATION IN AIR TRAFFIC CONTROL SERVICE PROVISION

- (a) If the displayed level information is not within the approved tolerance value or when a discrepancy in excess of the approved tolerance value is detected subsequent to verification, the pilot should be advised accordingly and requested to check the pressure setting and confirm the aircraft's level.
- (b) If, following confirmation of the correct pressure setting, the discrepancy continues to exist, the following actions should be taken by the air traffic controller according to circumstances:
 - (1) request the pilot to stop Mode C or ADS-B altitude data transmission, provided this does not cause the loss of position and identity information, and notify the next control positions or air traffic control unit concerned with the aircraft of the action taken; or
 - (2) inform the pilot of the discrepancy and request that the relevant operation continue in order to prevent loss of position and identity information of the aircraft and, when so prescribed by the local instructions, override the label-displayed level information with the reported level. In addition, the air traffic control unit should notify the next control position or air traffic control unit concerned with the aircraft of the action taken.
- (c) It should be highlighted that the airborne collision avoidance system (ACAS) will accept Mode C replies that are erroneous, and it is possible to issue a resolution advisory (RA) based on these inputs. When the measures described in point (b)(1) cannot be implemented, the air traffic controller should take into account the likelihood of generating ACAS RA in the air traffic services provision.

GM2 ATS.TR.155(f) ATS surveillance services

ED Decision 2020/008/R

ERRONEOUS LEVEL INFORMATION IN FLIGHT INFORMATION SERVICE PROVISION

The procedures for the verification of pressure-altitude-derived displayed information in the provision of flight information service should be established taking into consideration [GM1 ATS.TR.155\(f\)](#), and approved by the competent authority.

AMC1 ATS.TR.155(g) ATS surveillance services

ED Decision 2020/008/R

VERIFICATION OF LEVEL OCCUPANCY

- (a) In accordance with [AMC1 ATS.TR.155\(f\)](#), the criterion which should be used to determine that a specific level is occupied by an aircraft should be ± 60 m (± 200 ft) in RVSM airspace. In other

airspace, this criterion should be ± 90 m (± 300 ft), except that the competent authority may specify a smaller criterion, but not less than ± 60 m (± 200 ft), if this is found to be more practical.

(b) Aircraft maintaining a level

An aircraft should be considered to be maintaining its assigned level as long as the pressure-altitude-derived level information indicates that it is within the appropriate tolerances of the assigned level, as specified in point (a).

(c) Aircraft vacating a level

An aircraft cleared to leave a level should be considered to have commenced its manoeuvre and vacated the previously occupied level when the pressure-altitude-derived level information indicates a change of more than 90 m (300 ft) in the anticipated direction from its previously assigned level.

(d) Aircraft passing a level in climb or descent

An aircraft in climb or descent should be considered to have crossed a level when the pressure-altitude-derived level information indicates that it has passed this level in the required direction by more than 90 m (300 ft).

(e) Aircraft reaching a level

An aircraft should be considered to have reached the level to which it has been cleared when the elapsed time of three display updates, three sensor updates or 15 seconds, whichever is the greater, has passed since the pressure-altitude-derived level information has indicated that it is within the appropriate tolerances of the assigned level, as specified in point (a).

ATS.TR.160 Provision of air traffic services for flight testing

Commission Implementing Regulation (EU) 2020/469

Additional or alternative conditions and procedures to those contained in this Subpart B, to be applied by air traffic services units for the provision of air traffic services for flight testing, may be specified by the competent authority.

GM1 ATS.TR.160 Provision of air traffic services for flight testing

ED Decision 2020/008/R

SPECIAL AND ALTERNATIVE CONDITIONS AND OPERATING PROCEDURES FOR AIR TRAFFIC SERVICES PROVIDERS PROVIDING SERVICES TO FLIGHT TESTS

- (a) While flight tests are regularly conducted in compliance with the standards and the provisions specified in Subpart B of Annex IV, some of them need to follow specific additional or alternative conditions and procedures approved by the competent authority to meet the needs of flight tests carried out during the flight. This is also the case for flight tests involving more than one aircraft in the same flight test. These special provisions will not jeopardise the safety of the other airspace users and the population in the area overflown.
- (b) In order to ensure safe operations within the provision of air traffic service for flight tests control, the air traffic controllers, FIS officers and AFIS officers providing these services may need to have specific knowledge of flight tests and/or be briefed, depending on the specificities of the flight profiles.

-
- (c) Air traffic controllers that provide air traffic services to flight tests (flight test air traffic controllers) may need to obtain their specific competence through a dedicated training as specified in Commission Regulation (EU) 2015/340.
- (d) Air traffic services for flight tests should be provided through dedicated and specific procedures. These procedures should address the following:
- (1) Compatibility with other airspace users
 - (i) In order to ensure the compatibility of the flight test with other airspace users and to ensure safe operations and an acceptable rate of success of the flight test, the air traffic services provider should ensure proper coordination at all levels, including strategic, pre-tactical and real-time coordination.
 - (ii) The air traffic services unit providing services to flight tests is responsible for ensuring compatibility of their activities with other airspace users.
 - (2) Flight plan

The air traffic services unit should obtain all the necessary details related to flight tests (e.g. from the design organisation or the entity wishing to carry out the flight test).
 - (3) Flight tests with limited manoeuvrability
 - (i) During certain phases of the flight test, the capability to normally perform manoeuvres may only be possible after a necessary period of time (e.g. for the flight crew to get into a configuration that allows the execution of these manoeuvres).
 - (ii) The air traffic services provider should obtain the necessary information about the phases of flight and the duration if known.
 - (iii) For the conduct of these flights, the use of a temporarily reserved area is preferred. If unable, after prior coordination with the relevant air traffic services units neighbouring the flight tests, the use of a transponder should be mandated.
 - (iv) The real-time information on the development of the flight test as described in points (i)(ii)(iii) above does not relieve the air traffic services unit responsible for providing services to the flight tests from the obligation, when applicable, to ensure traffic separation and assure compatibility with all airspace users.
- (e) The above-mentioned procedures are not exhaustive and additional provisions may be necessary to meet the needs of flight tests. The paramount principle is anyhow to make provisions without contradicting the standards and the provisions specified in Subpart B of Annex IV.

SECTION 2 - AIR TRAFFIC CONTROL SERVICE

ATS.TR.200 Application

Commission Implementing Regulation (EU) 2020/469

Air traffic control service shall be provided:

- (a) to all IFR flights in airspace Classes A, B, C, D and E;
- (b) to all VFR flights in airspace Classes B, C and D;
- (c) to all special VFR flights;
- (d) to all aerodrome traffic at controlled aerodromes.

ATS.TR.205 Provision of air traffic control service

Commission Implementing Regulation (EU) 2020/469

The parts of air traffic control service described in point ATS.TR.105(a) shall be provided by the various units as follows:

- (a) area control service by either of the following units:
 - (1) an area control centre;
 - (2) the unit providing approach control service in a control zone or in a control area of limited extent which is designated primarily for the provision of approach control service and where no area control centre is established;
- (b) approach control service by either of the following units:
 - (1) an approach control unit when it is necessary or desirable to establish a separate unit;
 - (2) an aerodrome control tower or area control centre when it is necessary or desirable to combine under the responsibility of one unit the functions of the approach control service with those of the aerodrome control service or the area control service;
- (c) aerodrome control service: by an aerodrome control tower.

AMC1 ATS.TR.205 Provision of air traffic control service

ED Decision 2020/008/R

SECTORS AND WORKING POSITIONS AT AIR TRAFFIC CONTROL UNITS

The air traffic services provider should:

- (a) determine the area of responsibility for individual control sectors within an air traffic control unit, when applicable;
- (b) where there is more than one air traffic controller working position within a unit or sector, define the duties and responsibilities of the individual working positions.

GM1 ATS.TR.205 Provision of air traffic control service

ED Decision 2020/008/R

PROVISION OF APPROACH CONTROL SERVICE

Approach control service may be provided by a unit co-located with an area control centre (ACC), or by a control sector within an ACC.

AMC1 ATS.TR.205(c) Provision of air traffic control service

ED Decision 2020/008/R

FUNCTIONS OF AERODROME CONTROL TOWERS

- (a) Aerodrome control towers should issue information, instructions and clearances to aircraft under their control to achieve a safe, orderly and expeditious flow of air traffic on and in the vicinity of an aerodrome with the objective of preventing collision(s) between:
 - (1) aircraft flying within the designated area of responsibility of the control tower, including the aerodrome traffic circuits;
 - (2) aircraft operating on the manoeuvring area;
 - (3) aircraft landing and taking off;
 - (4) aircraft and vehicles operating on the manoeuvring area; and
 - (5) aircraft on the manoeuvring area and obstructions on that area.
- (b) Control of all flight operations on and in the vicinity of an aerodrome, as well as of vehicles and personnel on the manoeuvring area, should be continuously maintained by:
 - (1) visual observation, which can be achieved directly by out-of-the-window observation or through the use of a visual surveillance system; and
 - (2) an ATS surveillance system where available, in accordance with ATS.TR.245.
- (c) If there are other aerodromes within a control zone, traffic at all aerodromes within such a zone should be coordinated so that traffic circuits do not conflict.

GM1 to AMC1 ATS.TR.205(c) Provision of air traffic control service

ED Decision 2020/008/R

USE OF A VISUAL SURVEILLANCE SYSTEM IN AERODROME AIR TRAFFIC SERVICES

- (a) A visual surveillance system will normally consist of a number of integrated elements, including sensor(s), data transmission links, data processing systems and situation displays.
- (b) Visual surveillance systems used in the provision of aerodrome control services shall have an appropriate level of reliability, availability and integrity. The possibility of system failures or significant system degradations which may cause complete or partial interruptions of service should be assessed and taken into account in the definition of the level of service provided in order to ensure that there is no degradation in the safety level of the services provided. Backup facilities or alternative operational procedures should be provided.
- (c) Visual surveillance systems should be capable of receiving, processing and displaying, in an integrated manner, data from all connected resources.

- (d) Further information on visual surveillance systems in aerodrome air traffic services may be found in EASA ED Decision 2019/004/R, at <https://www.easa.europa.eu/document-library/agency-decisions/ed-decision-2019004r>.

GM1 ATS.TR.205(c) Provision of air traffic control service

ED Decision 2020/008/R

POSITIONS AT THE AERODROME CONTROL TOWER

- (a) The functions of an aerodrome control tower may be performed by different control or working positions, such as:
- (1) aerodrome air traffic controller, normally responsible for operations on the runway and aircraft flying within the area of responsibility of the aerodrome control tower;
 - (2) ground air traffic controller, normally responsible for traffic on the manoeuvring area with the exception of runways; and
 - (3) clearance delivery position, normally responsible for delivery of start-up and ATC clearances to departing IFR flights.
- (b) Where parallel or near-parallel runways are used for simultaneous operations, individual aerodrome air traffic controllers should be responsible for operations on each of the runways.

ATS.TR.210 Operation of air traffic control service

Commission Implementing Regulation (EU) 2020/469

- (a) In order to provide air traffic control service, an air traffic control unit shall:
- (1) be provided with information on the intended movement of each aircraft, or variations therefrom, and with current information on the actual progress of each aircraft;
 - (2) determine from the information received, the relative positions of known aircraft to each other;
 - (3) issue clearances, instructions or information, or all of them, for the purpose of preventing collision between aircraft under its control and of expediting and maintaining an orderly flow of traffic;
 - (4) coordinate clearances as necessary with other units:
 - (i) whenever an aircraft might otherwise conflict with traffic operated under the control of such other units;
 - (ii) before transferring control of an aircraft to such other units.
- (b) Clearances issued by air traffic control units shall provide separation:
- (1) between all flights in airspace Classes A and B;
 - (2) between IFR flights in airspace Classes C, D and E;
 - (3) between IFR flights and VFR flights in airspace Class C;
 - (4) between IFR flights and special VFR flights;
 - (5) between special VFR flights unless otherwise prescribed by the competent authority.

Where requested by the pilot of an aircraft and agreed by the pilot of the other aircraft and if so prescribed by the competent authority for the cases listed under point (2) of the first paragraph in airspace Classes D and E, a flight may be cleared subject to maintaining own separation in respect of a specific portion of the flight below 3 050 m (10 000 ft) during climb or descent, during day in visual meteorological conditions.

- (c) Except for cases of operations on parallel or near-parallel runways referred to in point [ATS.TR.255](#), or when a reduction in separation minima in the vicinity of aerodromes can be applied, separation by an air traffic control unit shall be obtained by at least one of the following:
- (1) vertical separation, obtained by assigning different levels selected from the table of cruising levels in Appendix 3 to the Annex to Implementing Regulation (EU) No 923/2012, except that the correlation of levels to track as prescribed therein shall not apply whenever otherwise indicated in appropriate aeronautical information publications or ATC clearances. The vertical separation minimum shall be a nominal 300 m (1 000 ft) up to and including FL 410 and a nominal 600 m (2 000 ft) above that level. Geometric height information shall not be used to establish vertical separation;
 - (2) horizontal separation, obtained by providing either of the following:
 - (i) longitudinal separation, by maintaining an interval between aircraft operating along the same, converging or reciprocal tracks, expressed in time or distance;
 - (ii) lateral separation, by maintaining aircraft on different routes or in different geographical areas.
- (d) When the air traffic controller becomes aware that the type of separation or minimum used to separate two aircraft cannot be maintained, the air traffic controller shall establish another type of separation or another minimum prior to the time when the current separation minimum would be infringed.

AMC1 ATS.TR.210(a)(3) Operation of air traffic control service

ED Decision 2020/008/R

HORIZONTAL SPEED CONTROL INSTRUCTIONS — GENERAL

- (a) In order to facilitate a safe and orderly flow of traffic, aircraft may, subject to conditions specified by the air traffic services provider, be instructed to adjust speed in a specified manner.
- (b) Flight crews should be given adequate notice of planned speed control.
- (c) Speed control instructions should remain in effect unless explicitly cancelled or amended by the air traffic controller.
- (d) Speed control should not be applied to aircraft entering or established in a holding pattern.
- (e) Speed adjustments should, as far as practicable, be limited to those necessary to establish and/or maintain a desired separation minimum or spacing. Instructions involving frequent changes of speed, including alternate speed increases and decreases, should be avoided.
- (f) When the flight crew inform the air traffic control unit concerned that they are unable to comply with a speed instruction, the air traffic controller should apply an alternative method to achieve the desired spacing between the aircraft concerned.

- (g) Except where otherwise approved by the competent authority, at levels at or above 7 600 m (FL 250), speed adjustments should be expressed in multiples of 0.01 Mach; at levels below 7 600 m (FL 250), speed adjustments should be expressed in multiples of 20 km/h (10 kt) based on indicated airspeed (IAS).
- (h) The air traffic controller should advise the flight crew when a speed control restriction is no longer required.

GM1 to AMC1 ATS.TR.210(a)(3) Operation of air traffic control service

ED Decision 2020/008/R

HORIZONTAL SPEED CONTROL INSTRUCTIONS — GENERAL

- (a) In order to establish a desired spacing between two or more successive aircraft, the air traffic controller should first either reduce the speed of the last aircraft, or increase the speed of the leading aircraft, then adjust the speed(s) of the other aircraft in order.
- (b) In order to maintain a desired spacing using speed control techniques, specific speeds need to be assigned to all the aircraft concerned.
- (c) The true airspeed (TAS) of an aircraft will decrease during descent when maintaining a constant IAS. When two descending aircraft maintain the same IAS, and the leading aircraft is at the lower level, the TAS of the leading aircraft will be lower than that of the following aircraft. The distance between the two aircraft will thus be reduced unless a sufficient speed differential is applied. For the purpose of calculating a desired speed differential between two succeeding aircraft, 11 km/h (6 kt) IAS per 300 m (1 000 ft) height difference may be used as a general rule. At levels below 2 450 m (FL 80), the difference between IAS and TAS is negligible for speed control purposes.
- (d) The time and distance required to achieve a desired spacing will increase with higher levels, higher speeds, and when the aircraft is in a clean configuration (see point (b) of [GM1 to AMC2 ATS.TR.210\(a\)\(3\)\)](#)).

GM2 to AMC1 ATS.TR.210(a)(3) Operation of air traffic control service

ED Decision 2020/008/R

HORIZONTAL SPEED CONTROL INSTRUCTIONS — AIRCRAFT PERFORMANCE AT HIGH LEVEL

When an aircraft is heavily loaded and at a high level, its ability to change speed may, in some cases, be very limited.

GM3 to AMC1 ATS.TR.210(a)(3) Operation of air traffic control service

ED Decision 2020/008/R

CANCELLATION OF HORIZONTAL SPEED INSTRUCTION

Cancellation of any speed control instruction does not relieve the flight crew of compliance with speed limitations associated with airspace classifications as specified in SERA.6001 'Classification of airspaces' of and in Appendix 4 to Regulation (EU) No 923/2012.

AMC2 ATS.TR.210(a)(3) Operation of air traffic control service

ED Decision 2020/008/R

HORIZONTAL SPEED CONTROL INSTRUCTIONS — DESCENDING AND ARRIVING AIRCRAFT

- (a) The air traffic controller should only apply speed reductions to less than 460 km/h (250 kt) IAS for turbojet aircraft during initial descent from cruising level with the concurrence of the flight crew.
- (b) The air traffic controller should use only minor speed adjustments not exceeding plus/minus 40 km/h (20 kt) IAS for aircraft on intermediate and final approach.
- (c) The air traffic controller should not apply speed control to aircraft after passing a point 7 km (4 NM) from the threshold on final approach.

GM1 to AMC2 ATS.TR.210(a)(3) Operation of air traffic control service

ED Decision 2020/008/R

HORIZONTAL SPEED CONTROL INSTRUCTIONS — DESCENDING AND ARRIVING AIRCRAFT

- (a) The air traffic controller should, when practicable, authorise an aircraft to absorb a period of notified terminal delay by cruising at a reduced speed for the latter portion of its flight.
- (b) The air traffic controller may instruct an aircraft to maintain its 'maximum speed', 'minimum clean speed', 'minimum speed', a specified speed or a speed equal to or less/more than a specified speed. 'Minimum clean speed' signifies the minimum speed at which an aircraft can be flown in a clean configuration, i.e. without deployment of lift-augmentation devices, speed brakes or landing gear.
- (c) The air traffic controller should avoid issuing instructions for an aircraft to simultaneously maintain a high rate of descent and reduce its speed, as such manoeuvres are normally not compatible. Any significant speed reduction during descent may require the aircraft to temporarily level off to reduce speed before continuing descent.
- (d) The air traffic controller should permit arriving aircraft to operate in a clean configuration for as long as possible. Below 4 550 m (FL 150), speed reductions for turbojet aircraft to not less than 410 km/h (220 kt) IAS, which will normally be very close to the minimum speed of turbojet aircraft in a clean configuration, may be used.

AMC3 ATS.TR.210(a)(3) Operation of air traffic control service

ED Decision 2020/008/R

VERTICAL SPEED CONTROL INSTRUCTIONS — GENERAL

- (a) In order to facilitate a safe and orderly flow of traffic, the air traffic controller may instruct aircraft to adjust rate of climb or rate of descent. The air traffic controller may apply vertical speed control between two or more climbing aircraft or two or more descending aircraft in order to establish or maintain a specific vertical separation minimum.
- (b) The air traffic controller should, as far as practicable, limit vertical speed adjustments to those necessary to establish and/or maintain a desired separation minimum, and should avoid instructions involving frequent changes of climb/descent rates.

- (c) When the flight crew inform the air traffic control unit concerned that they are unable to comply with a specified rate of climb or descent, the air traffic controller should apply an alternative method to achieve an appropriate separation minimum between aircraft, without delay.
- (d) The air traffic controller should advise aircraft when a rate of climb/descent restriction is no longer required.

GM1 to AMC3 ATS.TR.210(a)(3) Operation of air traffic control service

ED Decision 2020/008/R

VERTICAL SPEED CONTROL INSTRUCTIONS — GENERAL

- (a) The air traffic controller may instruct an aircraft to expedite climb or descent as appropriate to or through a specified level, or to reduce its rate of climb or rate of descent.
- (b) The air traffic controller may instruct climbing aircraft to maintain a specified rate of climb, a rate of climb equal to or greater than a specified value or a rate of climb equal to or less than a specified value.
- (c) The air traffic controller may instruct descending aircraft to maintain a specified rate of descent, a rate of descent equal to or greater than a specified value or a rate of descent equal to or less than a specified value.
- (d) In applying vertical speed control, the air traffic controller should ascertain to which level(s) climbing aircraft can sustain a specified rate of climb or, in the case of descending aircraft, the specified rate of descent which can be sustained.
- (e) Air traffic controllers should be aware of aircraft performance characteristics and limitations in relation to a simultaneous application of horizontal and vertical speed limitations.

AMC4 ATS.TR.210(a)(3) Operation of air traffic control service

ED Decision 2020/008/R

HOLDING CLEARANCE AND INSTRUCTIONS

When delay is expected, the ACC should clear aircraft to the holding fix, and:

- (a) include holding instructions; and
- (b) communicate in such clearances an expected approach time or onward clearance time, as applicable.

GM1 to AMC4 ATS.TR.210(a)(3) Operation of air traffic control service

ED Decision 2020/008/R

HOLDING CLEARANCE AND INSTRUCTIONS

- (a) In the event of extended delays, aircraft should be advised of the anticipated delay as early as possible and, when practicable, be instructed or given the option to reduce speed en-route in order to absorb the delay.
- (b) Holding and holding pattern entry should be accomplished in accordance with procedures published in AIPs. If entry and holding procedures have not been published or if the procedures

are not known to a flight crew, the appropriate air traffic control unit should specify the designator of the location or aid to be used, the inbound track, radial or bearing, direction of turn in the holding pattern as well as the time of the outbound leg or the distances between which to hold.

- (c) Air traffic services units should normally hold aircraft at a designated holding fix.
- (d) For the purpose of maintaining a safe and orderly flow of traffic, an aircraft may be instructed to orbit at its present or at any other position, provided the required obstacle clearance is ensured.

AMC5 ATS.TR.210(a)(3) Operation of air traffic control service

ED Decision 2020/008/R

APPROACH SEQUENCE

- (a) The approach sequence should be established in a manner which will facilitate the arrival of the maximum number of aircraft with the least average delay. Priority in the approach sequence should be given to:
 - (1) an aircraft which anticipates being compelled to land because of factors affecting the safe operation of the aircraft (engine failure, below minimum fuel state, etc.);
 - (2) hospital aircraft or aircraft carrying any sick or seriously injured person requiring urgent medical attention;
 - (3) aircraft engaged in search and rescue operations; and
 - (4) other aircraft as may be determined by the competent authority.
- (b) Succeeding aircraft should be cleared for approach when:
 - (1) the preceding aircraft has reported that it is able to complete its approach without encountering IMC; or
 - (2) the preceding aircraft is in communication with and sighted by the aerodrome control tower, and reasonable assurance exists that a normal landing can be accomplished; or
 - (3) timed approaches are used, the preceding aircraft has passed the defined point inbound, and reasonable assurance exists that a normal landing can be accomplished; or
 - (4) the use of an ATS surveillance system confirms that the required longitudinal spacing between succeeding aircraft has been established.

GM1 to AMC5 ATS.TR.210(a)(3) Operation of air traffic control service

ED Decision 2020/008/R

APPROACH SEQUENCE — SEQUENCING AND SPACING OF INSTRUMENT APPROACHES

- (a) Timed approach procedures
 - (1) The following procedure should be utilised as necessary to expedite the approaches of a number of arriving aircraft:

- (i) a suitable point on the approach path, which shall be capable of being accurately determined by the pilot, should be specified, to serve as a checkpoint in timing successive approaches;
 - (ii) aircraft should be given a time at which to pass the specified point inbound, which time should be determined with the aim of achieving the desired interval between successive landings on the runway while respecting the applicable separation minima at all times, including the period of runway occupancy.
- (2) The time at which aircraft shall pass the specified point should be determined by the unit providing approach control service and notified to the aircraft sufficiently in advance to permit the pilot to arrange the flight path accordingly.
- (3) Each aircraft in the approach sequence should be cleared to pass the specified point inbound at the previously notified time, or any revision thereof, after the preceding aircraft has reported passing the point inbound.
- (b) Interval between successive approaches

In determining the time interval or longitudinal distance to be applied between successive approaching aircraft, the relative speeds between succeeding aircraft, the distance from the specified point to the runway, the need to apply wake turbulence separation, runway occupancy times, the prevailing meteorological conditions as well as any condition which may affect runway occupancy times should be considered. When an ATS surveillance system is used to establish an approach sequence, the minimum distance to be established between succeeding aircraft should be specified in local instructions. Local instructions should additionally specify the circumstances under which any increased longitudinal distance between approaches may be required as well as the minima to be used under such circumstances.

AMC6 ATS.TR.210(a)(3) Operation of air traffic control service

ED Decision 2020/008/R

EXPECTED APPROACH TIME

- (a) The appropriate air traffic services unit should determine an expected approach time for an arriving aircraft that will be subjected to a delay of 10 minutes or more.
- (b) The expected approach time should be transmitted to the aircraft as soon as practicable and preferably not later than at the commencement of its initial descent from cruising level.
- (c) A revised expected approach time should be transmitted to the aircraft without delay whenever it differs from that previously transmitted by 5 minutes or more, or such lesser period of time as has been established by the competent authority or agreed between the air traffic services units concerned.
- (d) An expected approach time should be transmitted to the aircraft by the most expeditious means whenever it is anticipated that the aircraft will be required to hold for 30 minutes or more.
- (e) The holding fix to which an expected approach time relates should be identified together with the expected approach time whenever circumstances are such that this would not otherwise be evident to the pilot.

AMC7 ATS.TR.210(a)(3) Operation of air traffic control service

ED Decision 2020/008/R

ONWARD CLEARANCE TIME

In the event that an aircraft is held en-route or at a location or aid other than the initial approach fix (IAF), the appropriate air traffic services unit should, as soon as practicable, give the aircraft concerned an expected onward clearance time from the holding fix. The aircraft should also be advised if further holding at a subsequent holding fix is expected.

AMC8 ATS.TR.210(a)(3) Operation of air traffic control service

ED Decision 2020/008/R

INSTRUMENT APPROACH

- (a) The approach control unit should specify the instrument approach procedure to be used by arriving aircraft. When a flight crew requests an alternative instrument approach procedure, the approach control unit should clear it accordingly, if circumstances permit.
- (b) If a pilot reports or it is clearly apparent to the air traffic control unit that the pilot is not familiar with an instrument approach procedure, the initial approach level, the point (in minutes from the appropriate reporting point) at which base turn or procedure turn will be started, the level at which the procedure turn is to be carried out and the final approach track should be specified, except that only the last-mentioned need be specified if the aircraft is to be cleared for a straight-in approach. The frequency(-ies) of the navigation aid(s) to be used as well as the missed approach procedure should also be specified when deemed necessary.

GM1 to AMC8 ATS.TR.210(a)(3) Operation of air traffic control service

ED Decision 2020/008/R

INSTRUMENT APPROACH

If visual reference to terrain is established before completion of the approach procedure, the entire procedure should nevertheless be executed unless the aircraft requests and is cleared for a visual approach.

AMC9 ATS.TR.210(a)(3) Operation of air traffic control service

ED Decision 2020/008/R

VISUAL APPROACH

- (a) Subject to the conditions described in point (b), clearance for an IFR flight to execute a visual approach may be requested by a flight crew or initiated by the air traffic controller. In the latter case, the concurrence of the flight crew should be required.
- (b) An IFR flight should only be cleared to execute a visual approach, provided the pilot can maintain visual reference to the terrain and:
 - (1) the reported ceiling is at or above the level of the beginning of the initial approach segment for the aircraft so cleared; or

- (2) the pilot reports at the level of the beginning of the initial approach segment or at any time during the instrument approach procedure that the meteorological conditions are such that with reasonable assurance a visual approach and landing can be completed.
- (c) Except between aircraft performing successive visual approaches as described in point (d), separation should be provided between an aircraft cleared to execute a visual approach and other arriving and departing aircraft.
- (d) For successive visual approaches, separation should be maintained by the air traffic controller until the pilot of a succeeding aircraft reports having the preceding aircraft in sight. The aircraft should then be instructed to follow and maintain own separation from the preceding aircraft.
- (e) In case of aircraft performing successive visual approaches and instructed to maintain own separation as in point (d), and the distance between such aircraft is less than the appropriate wake turbulence minimum, the air traffic controller should issue a caution of possible wake turbulence.

GM1 to AMC9 ATS.TR.210(a)(3) Operation of air traffic control service

ED Decision 2020/008/R

VISUAL APPROACH

Air traffic controllers should exercise caution in initiating a visual approach when there is a reason to believe that the flight crew concerned is not familiar with the aerodrome and its surrounding terrain. Air traffic controllers should also take into consideration the prevailing traffic and meteorological conditions when initiating visual approaches. The responsibility of the pilot to inform the air traffic control unit, if an ATC clearance is not satisfactory, is specified in point (b)(2) of SERA.8015 of Regulation (EU) 923/2012.

AMC10 ATS.TR.210(a)(3) Operation of air traffic control service

ED Decision 2020/008/R

INFORMATION FOR ARRIVING AIRCRAFT

- (a) As early as practicable after an aircraft has established communication with the unit providing approach control service, the following elements of information, in the order listed, should be transmitted to the aircraft, with the exception of such elements which are known to have been already received by the aircraft:
 - (1) Type of approach and runway-in-use
 - (2) Meteorological information, as follows:
 - (i) surface wind direction and speed, including significant variations therein;
 - (ii) visibility and, when applicable, runway visual range (RVR);
 - (iii) present weather;
 - (iv) cloud below 1 500 m (5 000 ft) or below the highest minimum sector altitude, whichever is greater; cumulonimbus; if the sky is obscured, vertical visibility when available;
 - (v) air temperature;

- (vi) dew point temperature, inclusion determined on the basis of a regional air navigation agreement;
 - (vii) altimeter setting(s);
 - (viii) any available information on significant meteorological phenomena in the approach area; and
 - (ix) trend-type landing forecast, when available.
- (3) Current runway surface conditions, in case of precipitants or other temporary hazards
- (4) Changes in the operational status of visual and non-visual aids essential for approach and landing
- (b) At the commencement of final approach, the following information should be transmitted to aircraft:
- (1) significant changes in the mean surface wind direction and speed;
 - (2) the latest information, if any, on wind shear and/or turbulence in the final approach area; and
 - (3) the current visibility representative of the direction of approach and landing or, when provided, the current RVR value(s) and the trend.
- (c) During final approach, the following information should be transmitted without delay:
- (1) the sudden occurrence of hazards (e.g. unauthorised traffic on the runway);
 - (2) significant variations in the current surface wind, expressed in terms of minimum and maximum values;
 - (3) significant changes in runway surface conditions;
 - (4) changes in the operational status of required visual or non-visual aids; and
 - (5) changes in observed RVR value(s), in accordance with the reported scale in use, or changes in the visibility representative of the direction of approach and landing.

GM1 to AMC10 ATS.TR.210(a)(3) Operation of air traffic control service

ED Decision 2020/008/R

INFORMATION FOR ARRIVING AIRCRAFT

Significant variations are specified in point (a)(3) of MET.TR.205 of Annex V. However, if the air traffic controller possesses wind information in the form of components, the significant changes are:

- (a) mean headwind component: 19 km/h (10 kt);
- (b) mean tailwind component: 4 km/h (2 kt); and
- (c) mean crosswind component: 9 km/h (5 kt).

AMC11 ATS.TR.210(a)(3) Operation of air traffic control service

ED Decision 2020/008/R

START-UP TIME PROCEDURES

- (a) Start-up time procedures should be implemented where necessary to avoid congestion and excessive delays on the manoeuvring area or when necessary to comply with applicable air traffic flow management (ATFM) regulations. Start-up time procedures should be contained in local instructions and should specify the criteria and conditions for determining when and how start-up times should be calculated and issued to departing flights.
- (b) When so requested by the pilot prior to engine start, the aerodrome control tower should give an expected take-off time, unless engine start-up time procedures are employed.
- (c) A start-up clearance should only be withheld under circumstances or conditions specified by the air traffic services provider.
- (d) If a start-up clearance is withheld, the aerodrome control tower should advise the flight crew of the reason.

AMC12 ATS.TR.210(a)(3) Operation of air traffic control service

ED Decision 2020/008/R

INFORMATION TO AIRCRAFT BY AERODROME CONTROL TOWERS — AERODROME AND METEOROLOGICAL INFORMATION

- (a) Prior to taxiing for take-off, the aerodrome control tower should advise aircraft of the following elements of information, in the order listed, with the exception of such elements which are known to have been already received by the aircraft:
 - (1) the runway to be used;
 - (2) the surface wind direction and speed, including significant variations therein;
 - (3) the QNH altimeter setting and, either on a regular basis in accordance with local arrangements or if so requested by the aircraft, the QFE altimeter setting;
 - (4) the air temperature for the runway to be used, in the case of turbine-engined aircraft;
 - (5) the visibility representative of the direction of take-off and initial climb, if less than 10 km, or, when applicable, the RVR value(s) for the runway to be used; and
 - (6) the correct time.
- (b) Prior to take-off, the aerodrome control tower should advise aircraft of:
 - (1) any significant changes in the surface wind direction and speed, the air temperature, and the visibility or RVR value(s) given in accordance with point (a); and
 - (2) significant meteorological conditions in the take-off and climb-out area, except when it is known that the information has already been received by the aircraft.
- (c) Prior to entering the traffic circuit or commencing its approach to land, the relevant air traffic controller unit should provide aircraft with the following elements of information, in the order listed, with the exception of such elements which are known to have been already received by the aircraft:
 - (1) the runway to be used;

- (2) the surface wind direction and speed, including significant variations therein;
- (3) the QNH altimeter setting and, either on a regular basis in accordance with local arrangements or if so requested by the aircraft, the QFE altimeter setting; and
- (4) changes in observed RVR value(s), in accordance with the reported scale in use, or changes in the visibility representative of the direction of approach and landing.

GM1 to AMC12 ATS.TR.210(a)(3) Operation of air traffic control service

ED Decision 2020/008/R

SIGNIFICANT METEOROLOGICAL CONDITIONS IN THE TAKE-OFF AND CLIMB-OUT AREA

Significant meteorological conditions include the occurrence or expected occurrence of cumulonimbus or thunderstorm, moderate or severe turbulence, wind shear, hail, moderate or severe icing, severe squall line, freezing precipitation, severe mountain waves, sandstorm, dust storm, blowing snow, tornado or waterspout in the take-off and climb-out area.

AMC13 ATS.TR.210(a)(3) Operation of air traffic control service

ED Decision 2020/008/R

TAXI CLEARANCE

- (a) Prior to issuing a taxi clearance, the air traffic controller should determine where the aircraft concerned is parked. Taxi clearances should contain concise instructions and adequate information so as to assist the flight crew in following the correct taxi routes, in avoiding collision with other aircraft or objects and in minimising the potential for the aircraft inadvertently entering an active runway.
- (b) When a taxi clearance contains a taxi limit beyond a runway, it should contain an explicit clearance to cross or an instruction to hold short of that runway at a corresponding holding point.

GM1 to AMC13 ATS.TR.210(a)(3) Operation of air traffic control service

ED Decision 2020/008/R

TAXI CLEARANCE

Where standard taxi routes have not been published, the air traffic controller should, whenever possible, describe a taxi route, for example, by use of taxiway and runway designators or alternative identifiers. Other relevant information, such as an aircraft to follow or give way to, should also be provided to a taxiing aircraft.

GM2 to AMC13 ATS.TR.210(a)(3) Operation of air traffic control service

ED Decision 2020/008/R

HELICOPTER TAXI OPERATIONS

- (a) The provisions in points (b) to (f) may be considered and applied when wheeled helicopters or vertical take-off and landing (VTOL) aircraft taxi on the surface.
- (b) Ground taxiing uses less fuel than air-taxiing and minimises air turbulence. However, under certain conditions, such as rough, soft or uneven terrain, it may become necessary to air-taxi for safety considerations. Helicopters with articulating rotors (usually designs with three or more main rotor blades) are subject to 'ground resonance' and may, on rare occasions, suddenly lift off the ground to avoid severe damage or destruction.
- (c) When it is requested or necessary for a helicopter to proceed at a slow speed above the surface, normally below 37 km/h (20 kt) and in ground effect, air-taxiing may be authorised.
- (d) Instructions which require small aircraft or helicopters to taxi in close proximity to taxiing helicopters should be avoided and consideration should be given to the effect of turbulence from taxiing helicopters on arriving and departing light aircraft.
- (e) A frequency change should not be issued to single-pilot helicopters hovering or air-taxiing. Whenever possible, control instructions from the next air traffic services unit should be relayed as necessary until the pilot is able to change frequency.
- (f) Most light helicopters are flown by one pilot and require the constant use of both hands and feet to maintain control during low-altitude/low-level flight. Although flight control friction devices assist the pilot, changing frequency near the ground could result in inadvertent ground contact and consequent loss of control

GM3 to AMC13 ATS.TR.210(a)(3) Operation of air traffic control service

ED Decision 2020/008/R

TAXI CLEARANCE ACROSS A RUNWAY-IN-USE

When issuing a crossing instruction of a runway-in-use to a taxiing aircraft, air traffic controllers should ensure that the crossing instruction is issued on the same frequency as that utilised for the issuing of take-off and landing clearances on that runway. Any subsequent instruction to change frequency should be issued to the taxiing aircraft after it has vacated the runway

AMC14 ATS.TR.210(a)(3) Operation of air traffic control service

ED Decision 2020/008/R

TAXIING ON A RUNWAY-IN-USE

- (a) For the purpose of expediting air traffic, aircraft may be permitted to taxi on the runway-in-use, provided no delay or risk to other aircraft will result. Where control of taxiing aircraft is provided by a ground air traffic controller and the control of runway operations by an aerodrome air traffic controller, a clearance to taxi on the runway-in-use should be issued by the aerodrome air traffic controller once direct two-way communications between the pilot and the aerodrome air traffic controller have been established. Any subsequent instruction to change frequency

should be issued by the aerodrome air traffic controller to the taxiing aircraft after it has vacated the runway.

- (b) If the aerodrome air traffic controller is unable to determine, either visually or via an ATS surveillance system, that a vacating or crossing aircraft has cleared the runway, the aircraft should be requested to report when it has vacated the runway. The report should be made when the entire aircraft is beyond the relevant runway-holding position.

AMC15 ATS.TR.210(a)(3) Operation of air traffic control service

ED Decision 2020/008/R

USE OF RUNWAY-HOLDING POSITIONS

- (a) The air traffic controller should not hold aircraft closer to a runway-in-use than at a runway-holding position, except as in cases specified in point (b).
- (b) Aircraft should not be permitted to line up and hold on the approach end of a runway-in-use whenever another aircraft is effecting a landing, until the landing aircraft has passed the point of intended holding.

GM1 to AMC15 ATS.TR.210(a)(3) Operation of air traffic control service

ED Decision 2020/008/R

RUNWAY-HOLDING POSITIONS

The locations of runway-holding positions in relation to runways are specified in CS ADR-DSN.D.335 'Holding bays, runway-holding positions, intermediate holding positions, and road-holding positions' and in CS ADR-DSN.D.340 'Location of holding bays, runway-holding positions, intermediate holding positions, and road-holding positions' of EASA ED Decision 2014/013/R 'Certification Specifications and Guidance Material For Aerodromes Design', as last amended.

AMC16 ATS.TR.210(a)(3) Operation of air traffic control service

ED Decision 2020/008/R

RUNWAY INCURSION OR OBSTRUCTED RUNWAY

In the event that the aerodrome air traffic controller, after a take-off clearance or a landing clearance has been issued, becomes aware of a runway incursion or the imminent occurrence thereof, or the existence of any obstruction on or in close proximity to the runway likely to impair the safety of an aircraft taking off or landing, he or she should take appropriate action as follows:

- (a) cancel the take-off clearance for a departing aircraft;
- (b) instruct a landing aircraft to execute a go-around or missed approach; and
- (c) in all cases inform the aircraft of the runway incursion or obstruction and its location in relation to the runway.

GM1 to AMC16 ATS.TR.210(a)(3) Operation of air traffic control service

ED Decision 2020/008/R

RUNWAY INCURSION OR OBSTRUCTED RUNWAY

Animals and flocks of birds may constitute an obstruction with regard to runway operations. In addition, an aborted take-off or a go-around executed after touchdown may expose the aeroplane to the risk of overrunning the runway. Moreover, a low-altitude missed approach may expose the aeroplane to the risk of a tail strike. Pilots may therefore have to exercise their judgement, in accordance with SERA.2015 in Regulation (EU) No 923/2012, concerning the authority of the pilot-in-command of an aircraft.

GM2 to AMC16 ATS.TR.210(a)(3) Operation of air traffic control service

ED Decision 2020/008/R

CANCELLING A TAKE-OFF CLEARANCE FOR DEPARTING AIRCRAFT

- (a) If a take-off clearance has to be cancelled before the take-off run has commenced, the pilot should be instructed to hold position and to acknowledge the instruction.
- (b) In certain circumstances, the aerodrome air traffic controller may consider that it is necessary to cancel a take-off clearance after the aircraft has commenced the take-off run. In this event, the pilot should be instructed to stop immediately and to acknowledge the instruction.
- (c) The cancellation of a take-off clearance after an aircraft has commenced its take-off run should only occur when the aircraft will be in serious and imminent danger should it continue. Air traffic controllers should be aware of the potential for an aircraft to overrun the end of the runway if the take-off is abandoned at a late stage; this is particularly so with large aircraft or those operating close to their performance limit, such as at maximum take-off mass, in high ambient temperatures or when the runway braking action may be adversely affected. Because of this risk, even if a take-off clearance is cancelled, the pilot-in-command may consider it safer to continue the take-off than to attempt to stop the aircraft.
- (d) Air traffic controllers should also be aware of the possibility that an aircraft that abandons its take-off may suffer overheated brakes or another abnormal situation and should be prepared to declare the appropriate category of emergency or to provide other suitable assistance.

AMC17 ATS.TR.210(a)(3) Operation of air traffic control service

ED Decision 2020/008/R

AERODROME CONTROL — TAKE-OFF CLEARANCE

- (a) The aerodrome control tower may issue a take-off clearance to an aircraft when there is reasonable assurance that the separation for departing aircraft as in [AMC7 ATS.TR.210\(c\)\(2\)\(i\)](#), or the separation prescribed in accordance with [AMC9 ATS.TR.210\(c\)\(2\)\(i\)](#) for reduced runway separation minima between aircraft using the same runway, will exist when the aircraft commences take-off.
- (b) When an ATC clearance is required prior to take-off, the aerodrome control tower should not issue the take-off clearance until the ATC clearance has been transmitted to and acknowledged by the aircraft concerned. The ATC clearance should be forwarded to the aerodrome control

tower with the least possible delay after receipt of a request made by the tower or prior to such request if practicable.

- (c) Subject to point (b), the take-off clearance should be issued when the aircraft is ready for take-off and at or approaching the departure runway, and the traffic situation permits. To reduce the potential for misunderstanding, the take-off clearance should include the designator of the departure runway.

GM1 to AMC17 ATS.TR.210(a)(3) Operation of air traffic control service

ED Decision 2020/008/R

AERODROME CONTROL — CLEARANCE FOR IMMEDIATE TAKE-OFF

In the interest of expediting traffic, a clearance for immediate take-off may be issued to an aircraft before it enters the runway.

AMC18 ATS.TR.210(a)(3) Operation of air traffic control service

ED Decision 2020/008/R

AERODROME CONTROL — CLEARANCE TO LAND

The aerodrome control tower may clear an aircraft to land when there is reasonable assurance that the separation established in [AMC8 ATS.TR.210\(c\)\(2\)\(i\)](#), or the separation prescribed in accordance with [AMC9 ATS.TR.210\(c\)\(2\)\(i\)](#) for reduced runway separation minima between aircraft using the same runway, will exist when the aircraft crosses the runway threshold, provided that a clearance to land should not be issued until a preceding landing aircraft has crossed the runway threshold. To reduce the potential for misunderstanding, the landing clearance should include the designator of the landing runway.

AMC19 ATS.TR.210(a)(3) Operation of air traffic control service

ED Decision 2020/008/R

AERODROME CONTROL — PRIORITY FOR LANDING

In the provision of aerodrome control service, priority for landing should be given to:

- (a) an aircraft which anticipates being compelled to land because of factors affecting the safe operation of the aircraft (e.g. engine failure, shortage of fuel, etc.);
- (b) hospital aircraft or aircraft carrying any sick or seriously injured persons requiring urgent medical attention;
- (c) aircraft engaged in search and rescue operations; and
- (d) other aircraft as may be determined by the competent authority.

GM1 to AMC19 ATS.TR.210(a)(3) Operation of air traffic control service

ED Decision 2020/008/R

AERODROME CONTROL — PRIORITY FOR LANDING

- (a) An aircraft landing or in the final stages of an approach to land should normally have priority over an aircraft intending to depart from the same or an intersecting runway.
- (b) If an aircraft enters an aerodrome traffic circuit without proper authorisation, it should be permitted to land if its actions indicate that it so desires. If circumstances warrant, aircraft which are in contact with the air traffic controller may be instructed to give way so as to remove as soon as possible the hazard introduced by such unauthorised operation. In no case should permission to land be withheld indefinitely.
- (c) In cases of emergency, it may be necessary, in the interest of safety, for an aircraft to enter a traffic circuit and effect a landing without proper authorisation. Air traffic controllers should recognise the possibilities of emergency action and render all assistance possible.

AMC20 ATS.TR.210(a)(3) Operation of air traffic control service

ED Decision 2020/008/R

VISUAL DEPARTURE

- (a) An IFR flight may be cleared to execute a visual departure:
 - (1) when requested by the pilot; or
 - (2) prior to take-off, when initiated by the air traffic controller and accepted by the pilot by a read-back of the ATC clearance.
- (b) When implemented, visual departure should be applied under the following conditions:
 - (1) the meteorological conditions in the direction of take-off and the following climb-out are such that they do not impair the procedure up to the established altitude published in the AIP, e.g. minimum flight altitude (MFA) or minimum sector altitude (MSA);
 - (2) the procedure is to be applied during the daytime;
 - (3) the pilot is responsible for maintaining obstacle clearance until the specified altitude. Further clearance (route, heading, point) should be specified by the air traffic controller; and
 - (4) separation is provided between an aircraft cleared to execute a visual departure and other aircraft, in accordance with the airspace classification.
- (c) Any additional local restrictions should be agreed upon in consultation between the air traffic services provider and operators.

GM1 to AMC20 ATS.TR.210(a)(3) Operation of air traffic control service

ED Decision 2020/008/R

VISUAL DEPARTURE

If the aircraft is in or may enter airspace class D during the application of the visual departure, attention is drawn to the requirement to provide timely VFR traffic information deemed relevant for the aircraft executing the visual departure. Flight crews should be made aware when the application of the visual departure may lead the departing aircraft to enter airspace classes E, F or G.

GM2 to AMC20 ATS.TR.210(a)(3) Operation of air traffic control service

ED Decision 2020/008/R

FLIGHT CREW ACCEPTANCE OF VISUAL DEPARTURE

Flight crew acceptance of the clearance for visual departure will indicate that the aircraft take-off performance characteristics allow an early turn after take-off.

AMC21 ATS.TR.210(a)(3) Operation of air traffic control service

ED Decision 2020/008/R

MISSED APPROACHES INSTRUCTIONS

When issuing instructions for a missed approach to a flight conducting an instrument approach procedure, the air traffic controller should adhere to the published missed approach procedure. The air traffic controller should issue modifications to the published missed approach procedure only in presence of safety reasons.

GM1 ATS.TR.210(a)(3) Operation of air traffic control service

ED Decision 2020/008/R

AERODROME CONTROL — CLEARANCES IN THE TRAFFIC CIRCUIT

- (a) The clearance to enter the traffic circuit should be issued to an aircraft whenever it is desired that the aircraft approach the landing area in accordance with current traffic circuits but traffic conditions do not yet allow a landing clearance to be issued. Depending on the circumstances and traffic conditions, an aircraft may be cleared to join at any position in the traffic circuit.
- (b) When so instructed by the air traffic controller, pilots should obtain approval prior to turning on to any of the aerodrome traffic circuit legs. When extending an aerodrome traffic circuit leg, pilots should report to the air traffic control unit as soon as there is a risk that visual contact with the runway cannot be maintained.
- (c) An arriving aircraft executing an instrument approach should normally be cleared to land straight in unless visual manoeuvring to the landing runway is required.

GM2 ATS.TR.210(a)(3) Operation of air traffic control service

ED Decision 2020/008/R

AERODROME CONTROL — INSTRUCTIONS FOR LANDING AND ROLL-OUT MANOEUVRES

- (a) When necessary or desirable in order to expedite traffic, the aerodrome control tower may request a landing aircraft to:
 - (1) hold short of an intersecting runway after landing;
 - (2) land beyond the touchdown zone of the runway;
 - (3) vacate the runway at a specified exit taxiway; and
 - (4) expedite vacating the runway.
- (b) In requesting a landing aircraft to perform a specific landing and/or roll-out manoeuvre, the type of aircraft, runway length, location of exit taxiways, reported braking action on runway and taxiway, and prevailing meteorological conditions should be considered. A HEAVY aircraft should not be requested to land beyond the touchdown zone of a runway.
- (c) When necessary or desirable, e.g. due to low-visibility conditions, a landing or a taxiing aircraft may be instructed to report when a runway has been vacated. The report should be made when the entire aircraft is beyond the relevant runway-holding position.

GM3 ATS.TR.210(a)(3) Operation of air traffic control service

ED Decision 2020/008/R

FORMULATION OF INSTRUCTIONS AND INFORMATION TO AIRCRAFT ON THE GROUND

As the view from the flight deck of an aircraft is normally restricted, the air traffic controller should ensure that instructions and information which require the flight crew to employ visual detection, recognition and observation are phrased in a clear, concise and complete manner.

GM4 ATS.TR.210(a)(3) Operation of air traffic control service

ED Decision 2020/008/R

INFORMATION ON JET BLAST AND PROPELLER SLIPSTREAM

- (a) In issuing clearances or instructions, air traffic controllers should take into account the hazards caused by jet blast and propeller slipstream to taxiing aircraft, to aircraft taking off or landing, particularly when intersecting runways are being used, and to vehicles and personnel operating on the aerodrome.
- (b) Jet blast and propeller slipstream can produce localised wind velocities of sufficient strength to cause damage to other aircraft, vehicles and personnel operating within the affected area.

GM5 ATS.TR.210(a)(3) Operation of air traffic control service

ED Decision 2020/008/R

DESIGNATED POSITIONS OF AIRCRAFT IN THE AERODROME TRAFFIC AND TAXI CIRCUIT IN RELATION TO AERODROME CONTROL TOWER CLEARANCES

The following positions of aircraft in the traffic and taxi circuits, as shown in Figure 1, are the positions where aircraft normally receive aerodrome control tower clearances. Aircraft should be watched

closely as they approach these positions so that proper clearances may be issued without delay. Where practicable, all clearances should be issued without waiting for aircraft to initiate the call.

- Position 1. Aircraft initiates call to taxi for departing flight. Runway-in-use information and taxi clearances given.
- Position 2. If there is conflicting traffic, the departing aircraft will be held at this position. Engine run-up will, when required, normally be performed here.
- Position 3. Take-off clearance is issued here if not practicable at position 2.
- Position 4. Clearance to land is issued here as practicable.
- Position 5. Clearance to taxi to apron is issued here.
- Position 6. Parking information is issued here if necessary.

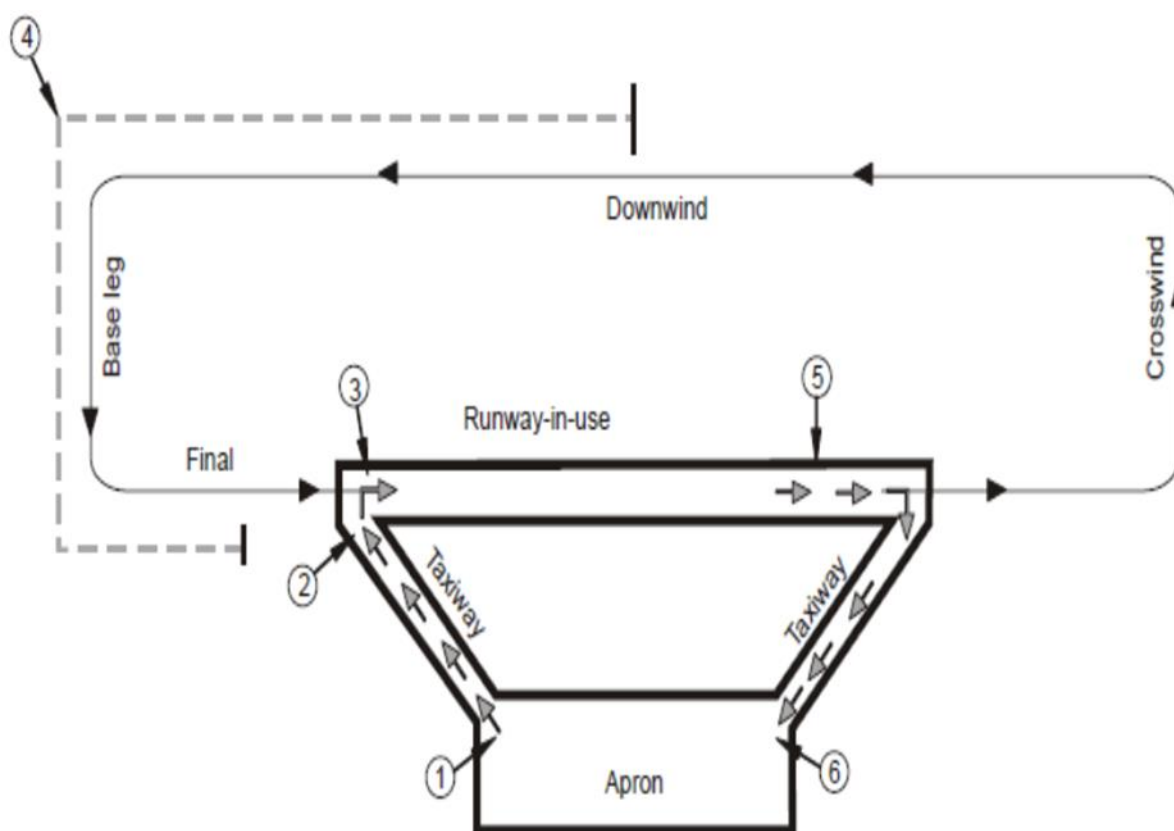

Figure 1

GM6 ATS.TR.210(a)(3) Operation of air traffic control service

ED Decision 2020/008/R

AERODROME CONTROL — PRIORITY FOR DEPARTURE

Departures should normally be cleared in the order in which aircraft are ready for take-off, except that deviations may be made from this order of priority to facilitate the maximum number of departures with the least average delay. Factors which should be considered in relation to the departure sequence include, inter alia:

- (a) types of aircraft and their relative performance;
- (b) routes to be followed after take-off;
- (c) any specified minimum departure interval between take-offs;
- (d) need to apply wake turbulence separation minima;
- (e) aircraft which should be afforded priority; and
- (f) aircraft subject to ATFM requirements.

GM7 ATS.TR.210(a)(3) Operation of air traffic control service

ED Decision 2020/008/R

AERODROME CONTROL — PRIORITY FOR DEPARTURE AND ATFM MEASURES

For aircraft subject to ATFM requirements, it is the responsibility of the pilot and the operator to ensure that the aircraft is ready to taxi in time to meet any required departure time, bearing in mind that once a departure sequence is established on the taxiway system, it can be difficult, and sometimes impossible, to change the order.

GM1 ATS.TR.210(b) Operation of air traffic control service

ED Decision 2020/008/R

CLEARANCES TO FLY MAINTAINING OWN SEPARATION WHILE IN VISUAL METEOROLOGICAL CONDITIONS

- (a) If there is a possibility that flight under visual meteorological conditions (VMC) may become impracticable, an IFR flight should be provided with alternative instructions to be complied with in the event that flight in VMC cannot be maintained for the term of the clearance.
- (b) The pilot of an IFR flight, on observing that conditions are deteriorating and considering that operation in VMC will become impossible, should inform the air traffic control unit before entering instrumental meteorological conditions (IMC) and should proceed in accordance with the alternative instructions given.

GM2 ATS.TR.210(b) Operation of air traffic control service

ED Decision 2020/008/R

CLEARANCES TO FLY MAINTAINING OWN SEPARATION WHILE IN VISUAL METEOROLOGICAL CONDITIONS

- (a) The provision of vertical or horizontal separation by an air traffic unit is not applicable in respect of any specified portion of a flight cleared subject to maintaining own separation and remaining in VMC. It is for the aircraft so cleared to ensure, for the duration of the clearance, that it is not operated in such proximity to other flights as to create a collision hazard.
- (b) It is axiomatic that a VFR flight must remain in VMC at all times. Accordingly, the issuance of a clearance to a VFR flight to fly subject to maintaining own separation and remaining in VMC has no other object than to signify that, for the duration of the clearance, separation from other aircraft by air traffic control unit is not provided.
- (c) It should be noted that the objectives of the air traffic control service as prescribed in ATS.TR.100 do not include prevention of collision with terrain. Pilots are responsible for ensuring that any clearances issued by air traffic control units are safe in this respect. When vectoring or assigning a direct routing not included in the flight plan, which takes an IFR flight

off published ATS route or instrument procedure, the procedures in point (a)(5) of ATS.TR.235 apply.

AMC1 ATS.TR.210(c) Operation of air traffic control service

ED Decision 2020/008/R

EMERGENCY SEPARATION APPLICATION

- (a) If, during an emergency situation, it is not possible to ensure that the applicable horizontal separation can be maintained, emergency separation of half the applicable vertical separation minimum may be used, i.e. a nominal 150 m (500 ft) between aircraft in airspace where a vertical separation minimum of 300 m (1 000 ft) is applied, and a nominal 300 m (1 000 ft) between aircraft in airspace where a 600 m (2 000 ft) vertical separation minimum is applied.
- (b) When emergency separation is applied, the flight crews concerned should be advised that emergency separation is being applied, and informed of the actual minimum used. Additionally, all flight crews concerned should be provided with essential traffic information.

GM1 to AMC1 ATS.TR.210(c) Operation of air traffic control service

ED Decision 2020/008/R

SEPARATION APPLICATION IN CASE OF ATS SURVEILLANCE SYSTEM FAILURE

As an emergency measure, in the event of complete failure of the ATS surveillance system where air-ground communications remain, the use of flight levels spaced by half the applicable vertical separation minimum may be resorted to temporarily if standard procedural separation cannot be provided immediately.

GM2 ATS.TR.210(c) Operation of air traffic control service

ED Decision 2020/008/R

PROCEDURAL SEPARATION — APPLICATION OF LARGER SEPARATION MINIMA UNDER SPECIFIC CIRCUMSTANCES

Larger separations than the specified minima should be applied whenever exceptional circumstances such as unlawful interference or navigational difficulties call for extra precautions. This should be done with due regard to all relevant factors so as to avoid impeding the flow of air traffic by the application of excessive separations.

AMC1 ATS.TR.210(c)(1) Operation of air traffic control

ED Decision 2020/008/R

PROCEDURAL SEPARATION — SEPARATION OF AIRCRAFT HOLDING IN FLIGHT

- (a) Aircraft established in adjacent holding patterns should, except when lateral separation between the holding areas exists as determined by the air traffic services provider and approved by the competent authority, be separated by the applicable vertical separation minimum.
- (b) Except when lateral separation exists, the air traffic controller should apply vertical separation between aircraft holding in flight and other aircraft, whether arriving, departing or en-route, whenever the other aircraft concerned are within 5 minutes flying time of the holding area or within a distance established by the air traffic services provider and approved by the competent authority (see Figure 2).

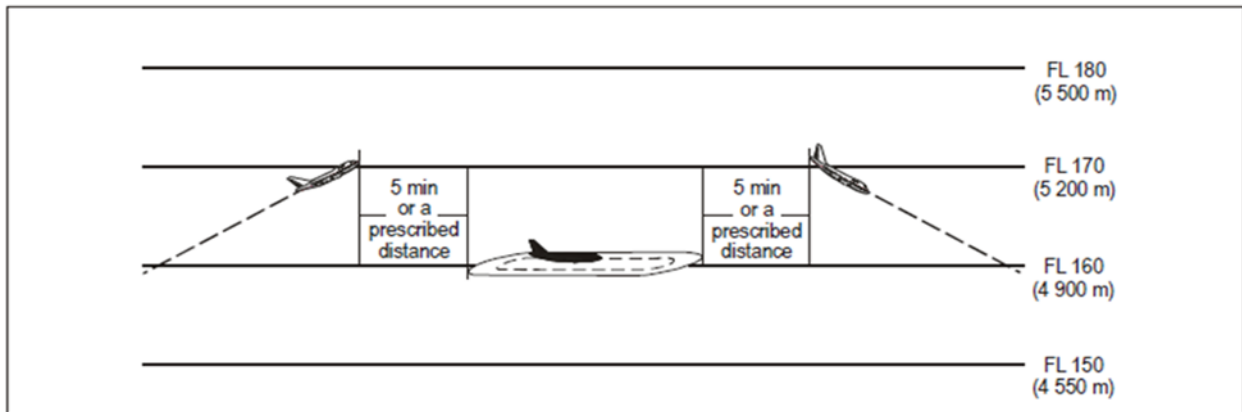

Figure 2 Separation between holding aircraft and en-route aircraft

GM1 to AMC1 ATS.TR.210(c)(1) Operation of air traffic control service

ED Decision 2020/008/R

SEPARATION OF AIRCRAFT HOLDING IN FLIGHT

Criteria and procedures for the simultaneous use of adjacent holding patterns should be prescribed in local instructions.

GM1 ATS.TR.210(c)(1) Operation of air traffic control service

ED Decision 2020/008/R

VERTICAL SEPARATION APPLICATION

Vertical separation is obtained by requiring aircraft using prescribed altimeter setting procedures to operate at different levels expressed in terms of flight levels or altitudes, in accordance with the provisions in [ATS.TR.125](#), [ATS.TR.130](#), [ATS.TR.135](#) and [ATS.TR.140](#).

GM2 ATS.TR.210(c)(1) Operation of air traffic control service

ED Decision 2020/008/R

APPLICATION OF VERTICAL SEPARATION DURING CLIMB OR DESCENT

- (a) An aircraft may be cleared to a level previously occupied by another aircraft after the latter has reported vacating it, except when:
- (1) severe turbulence is known to exist;
 - (2) the higher aircraft is effecting a cruise climb; or
 - (3) the difference in aircraft performance is such that less than the applicable separation minimum may result;

in which case such clearance should be withheld until the aircraft vacating the level has reported at or passing another level separated by the required minimum.

- (b) When the aircraft concerned are entering or established in the same holding pattern, consideration should be given to aircraft descending at markedly different rates and, if necessary, additional measures such as specifying a maximum descent rate for the higher

aircraft and a minimum descent rate for the lower aircraft should be applied to ensure that the required separation is maintained.

GM3 ATS.TR.210(c)(1) Operation of air traffic control service

ED Decision 2020/008/R

GEOMETRIC HEIGHT INFORMATION

Geometric height information is generated by airborne systems such as, for instance, GPS or radio altimeters.

AMC1 ATS.TR.210(c)(2) Operation of air traffic control service

ED Decision 2020/008/R

HORIZONTAL SEPARATION MINIMA BASED ON ATS SURVEILLANCE SYSTEM

- (a) Unless otherwise prescribed in accordance with point (b), or [AMC6 ATS.TR.220](#), or point (d) of [AMC7 ATS.TR.220](#), or [ATS.TR.255](#), the horizontal separation minimum based on radar and/or ADS-B and/or MLAT systems should be 9.3 km (5.0 NM).
- (b) If so established by the air traffic services provider and approved by the competent authority, the separation minimum in point (a) may be reduced but not below:
 - (1) 5.6 km (3.0 NM) when radar and/or ADS-B and/or MLAT systems' capabilities at a given location so permit; and
 - (2) 4.6 km (2.5 NM) between succeeding aircraft which are established on the same final approach track within 18.5 km (10 NM) of the runway threshold. A reduced separation minimum of 4.6 km (2.5 NM) may be applied, provided:
 - (i) the average runway occupancy time of landing aircraft is proven, by means such as data collection and statistical analysis and methods based on a theoretical model, not to exceed 50 seconds;
 - (ii) braking action is reported as good and runway occupancy times are not adversely affected by runway contaminants such as slush, snow or ice;
 - (iii) an ATS surveillance system with appropriate azimuth and range resolution and an update rate of 5 seconds or less is used in combination with suitable displays;
 - (iv) the aerodrome air traffic controller is able to observe, visually or by means of surface movement radar (SMR), MLAT system or a surface movement guidance and control system (SMGCS), the runway-in-use and associated exit and entry taxiways;
 - (v) wake turbulence separation minima in AMC6 ATS.TR.220 or in point (d) of AMC7 ATS.TR.220, or as may be prescribed by the air traffic services provider and approved by the competent authority (e.g. for specific aircraft types), do not apply;
 - (vi) aircraft approach speeds are closely monitored by the air traffic controller and when necessary adjusted so as to ensure that separation is not reduced below the minimum;
 - (vii) aircraft operators and pilots have been made fully aware of the need to exit the runway in an expeditious manner whenever the reduced separation minimum on final approach is applied; and

- (viii) procedures concerning the application of the reduced minimum are published in AIPs.

GM1 to AMC1 ATS.TR.210(c)(2) Operation of air traffic control service

ED Decision 2020/008/R

CRITERIA FOR APPLICATION OF HORIZONTAL SEPARATION BASED ON RADAR AND/OR ADS-B AND/OR MLAT SYSTEMS

- (a) The separation minimum or minima based on radar and/or ADS-B and/or MLAT systems to be applied should be prescribed by the air traffic services provider and approved by the competent authority according to the capability of the particular ATS surveillance system or sensor to accurately identify the aircraft position in relation to the centre of a position symbol, PSR blip, SSR response and taking into account factors which may affect the accuracy of the ATS surveillance system-derived information, such as aircraft range from the radar site and the range scale of the situation display in use.
- (b) Separation based on the use of ADS-B, SSR and/or MLAT, and/or PSR position symbols and/or PSR blips should be applied so that the distance between the centres of the position symbols and/or PSR blips, representing the positions of the aircraft concerned, is never less than a prescribed minimum.
- (c) Separation based on the use of PSR blips and SSR responses should be applied so that the distance between the centre of the PSR blip and the nearest edge of the SSR response (or centre, when authorised by the competent authority) is never less than a prescribed minimum.
- (d) Separation based on the use of ADS-B position symbols and SSR responses should be applied so that the distance between the centre of the ADS-B position symbol and the nearest edge of the SSR response (or the centre, when authorised by the competent authority) is never less than a prescribed minimum.
- (e) Separation based on the use of SSR responses should be applied so that the distance between the closest edges of the SSR responses (of the centres, when authorised by the competent authority) is never less than a prescribed minimum.
- (f) In no circumstances should the edges of the position indications touch or overlap unless vertical separation is applied between the aircraft concerned, irrespective of the type of position indication displayed and separation minimum applied.

AMC2 ATS.TR.210(c)(2) Operation of air traffic control service

ED Decision 2020/008/R

SPECIFIC CONDITIONS AND LIMITATIONS FOR THE APPLICATION OF SEPARATION MINIMA BASED ON ATS SURVEILLANCE SYSTEM

- (a) The separation minima based on ATS surveillance systems specified in [AMC1 ATS.TR.210\(c\)\(2\)](#), [AMC6 ATS.TR.220](#) and point (d) of [AMC7 ATS.TR.220](#) may be applied between an aircraft taking off and a preceding departing aircraft or other identified traffic, provided there is reasonable assurance that the departing aircraft will be identified within 2 km (1 NM) from the end of the runway, and that, at the time, the required separation will exist.
- (b) The separation minima specified based on ATS surveillance systems should not be applied between aircraft holding over the same holding fix.

AMC3 ATS.TR.210(c)(2) Operation of air traffic control service

ED Decision 2020/008/R

PROCEDURAL SEPARATION — REDUCTION IN LATERAL AND LONGITUDINAL SEPARATION MINIMA

(a) Provided that prior consultation with airspace users is undertaken and that an appropriate safety assessment has shown that an acceptable level of safety is maintained, the lateral and longitudinal separation minima established in:

- [AMC1 ATS.TR.210\(c\)\(2\)\(i\)](#);
- [AMC2 ATS.TR.210\(c\)\(2\)\(i\)](#);
- [AMC3 ATS.TR.210\(c\)\(2\)\(i\)](#);
- [AMC4 ATS.TR.210\(c\)\(2\)\(i\)](#);
- [AMC5 ATS.TR.210\(c\)\(2\)\(i\)](#);
- [AMC6 ATS.TR.210\(c\)\(2\)\(i\)](#); and
- [AMC1 ATS.TR.210\(c\)\(2\)\(ii\)](#)

may be reduced in the following circumstances:

- (1) when special electronic or other aids enable the pilot-in-command of an aircraft to determine accurately the aircraft's position and when adequate communication facilities exist for that position to be transmitted without delay to the appropriate air traffic control unit; or
- (2) when, in association with rapid and reliable communication facilities, information of an aircraft's position, derived from an ATS surveillance system, is available to the appropriate air traffic control unit; or
- (3) when RNAV-equipped aircraft operate within the coverage of electronic aids that provide the necessary updates to maintain navigation accuracy.

(b) In addition to the circumstances mentioned in point (a), the lateral and longitudinal separation minima established in:

- [AMC1 ATS.TR.210\(c\)\(2\)\(i\)](#);
- [AMC2 ATS.TR.210\(c\)\(2\)\(i\)](#);
- [AMC3 ATS.TR.210\(c\)\(2\)\(i\)](#);
- [AMC4 ATS.TR.210\(c\)\(2\)\(i\)](#);
- [AMC5 ATS.TR.210\(c\)\(2\)\(i\)](#);
- [AMC6 ATS.TR.210\(c\)\(2\)\(i\)](#); and
- [AMC1 ATS.TR.210\(c\)\(2\)\(ii\)](#)

may be reduced in the vicinity of aerodromes if:

- (1) adequate separation can be provided by the aerodrome air traffic controller when each aircraft is continuously visible to this air traffic controller; or
- (2) each aircraft is continuously visible to flight crews of the other aircraft concerned and the pilots thereof report that they can maintain their own separation; or

- (3) in the case of one aircraft following another, the flight crew of the succeeding aircraft reports that the other aircraft is in sight and separation can be maintained.

GM1 ATS.TR.210(c)(2)(i) Operation of air traffic control service

ED Decision 2020/008/R

PROCEDURAL SEPARATION — LONGITUDINAL SEPARATION APPLICATION

- (a) Longitudinal separation should be applied so that the spacing between the estimated positions of the aircraft being separated is never less than a prescribed minimum. Longitudinal separation between aircraft following the same or diverging tracks may be maintained by application of speed control, including the Mach number technique. When applicable, use of the Mach number technique should be prescribed on the basis of a regional air navigation agreement.
- (b) Longitudinal separation between supersonic aircraft during the transonic acceleration and supersonic phases of flight should normally be established by appropriate timing of the start of transonic acceleration rather than by the imposition of speed restrictions in supersonic flight.
- (c) Time-based separation applied in accordance with [AMC1 ATS.TR.210\(c\)\(2\)\(i\)](#), [AMC2 ATS.TR.210\(c\)\(2\)\(i\)](#) and [AMC5 ATS.TR.210\(c\)\(2\)\(i\)](#) may be based on position information and estimates derived from voice reports, controller-pilot data link communications (CPDLC) or ADS-C.
- (d) For the purpose of application of longitudinal separation, the terms ‘same track’, ‘reciprocal tracks’ and ‘crossing tracks’ have the following meanings:
- (1) Same track (see Figure 3)

Same direction tracks and intersecting tracks or portions thereof, the angular difference of which is less than 45 degrees or more than 315 degrees, and whose protected airspaces overlap

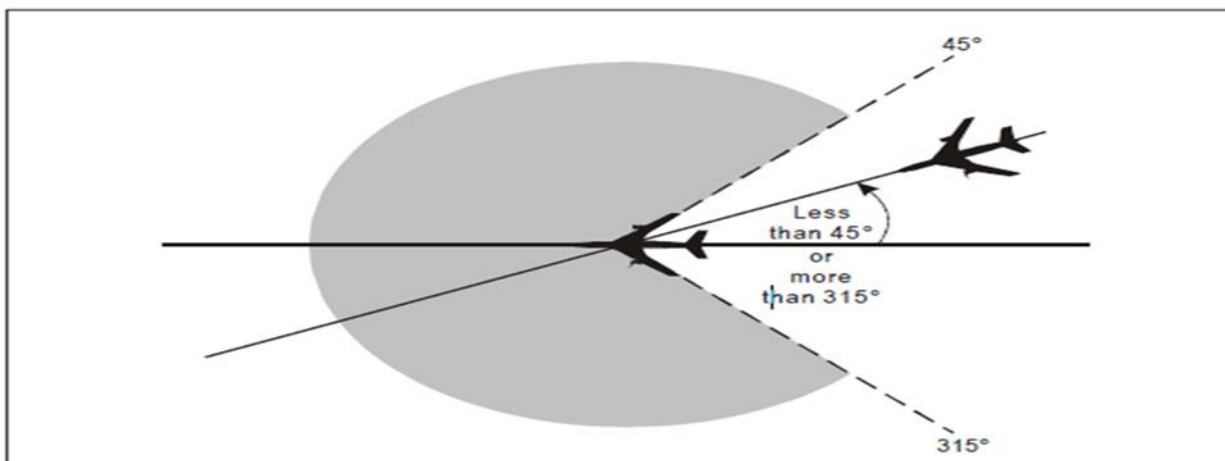

Figure 3: Aircraft on same track

- (2) Reciprocal tracks (see Figure 4)

Opposite tracks and intersecting tracks or portions thereof, the angular difference of which is more than 135 degrees but less than 225 degrees, and whose protected airspaces overlap

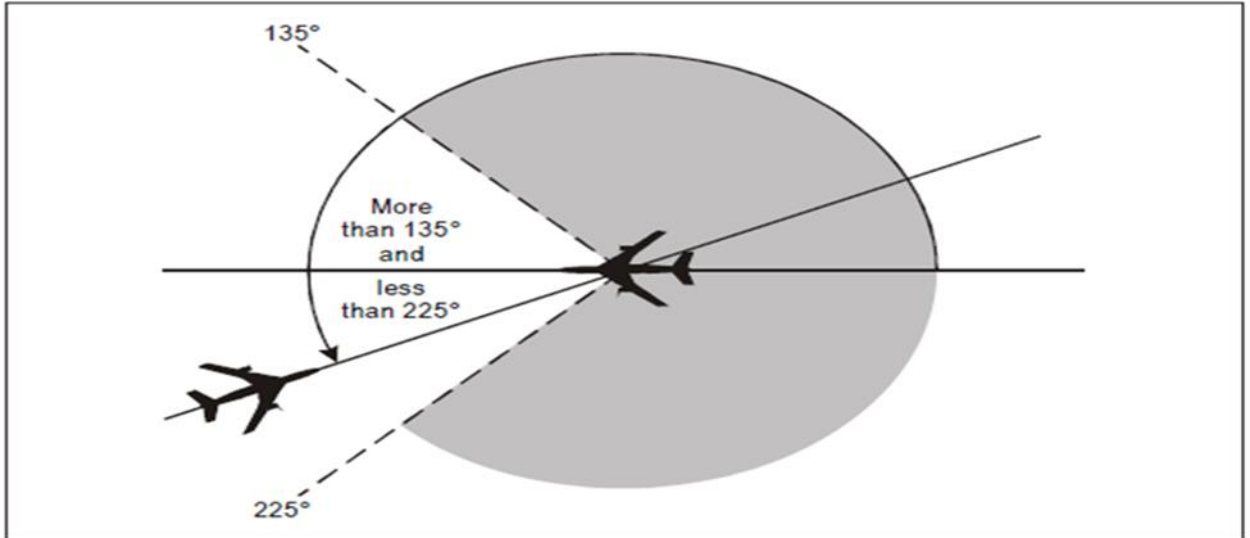

Figure 4: Aircraft on reciprocal tracks

- (3) Crossing tracks (see Figure 5)

Intersecting tracks or portions thereof other than those specified in points (1) and (2)

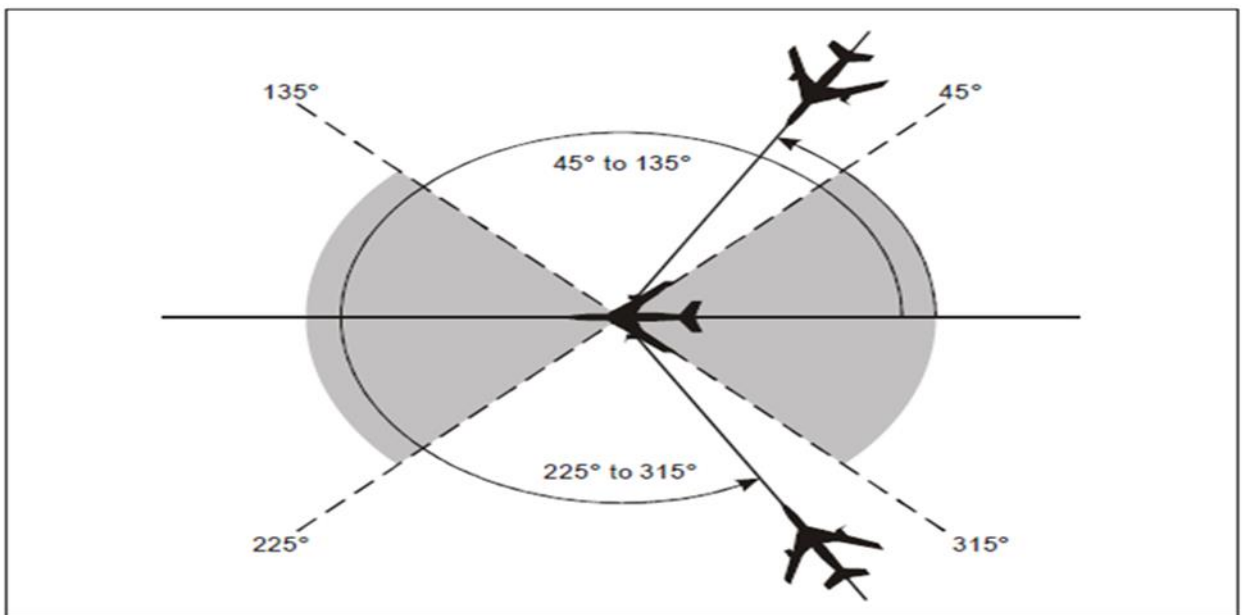

Figure 5: Aircraft on crossing tracks

AMC1 ATS.TR.210(c)(2)(i) Operation of air traffic control service

ED Decision 2020/008/R

PROCEDURAL SEPARATION — LONGITUDINAL SEPARATION MINIMA BASED ON TIME — AIRCRAFT MAINTAINING THE SAME LEVEL

For aircraft flying at the same level, the longitudinal separation minima based on time should be one of the following:

- (a) Aircraft flying on the same track and same level
- (1) 15 minutes (see Figure 6); or

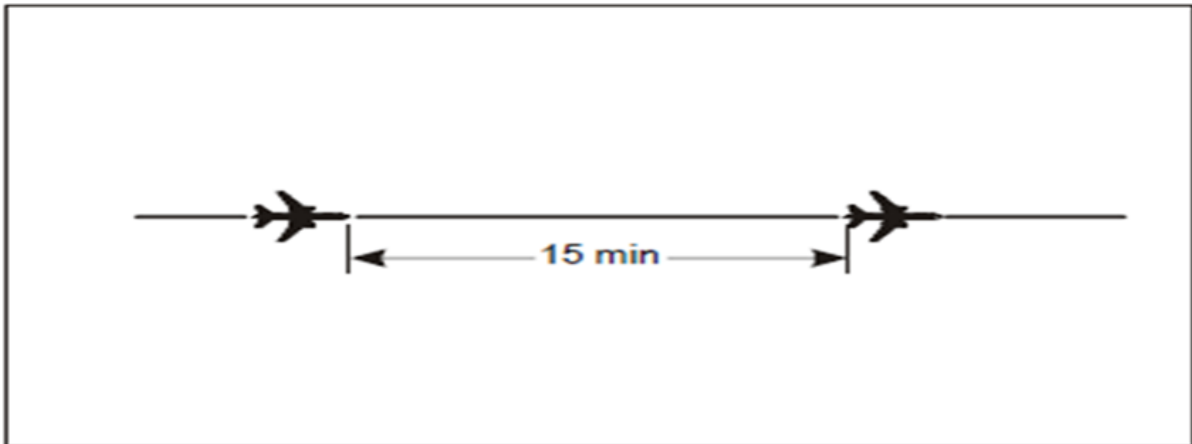

Figure 6: 15-minute separation between aircraft on the same track and same level

- (2) 10 minutes if navigation aids permit frequent determination of position and speed (see Figure 7); or

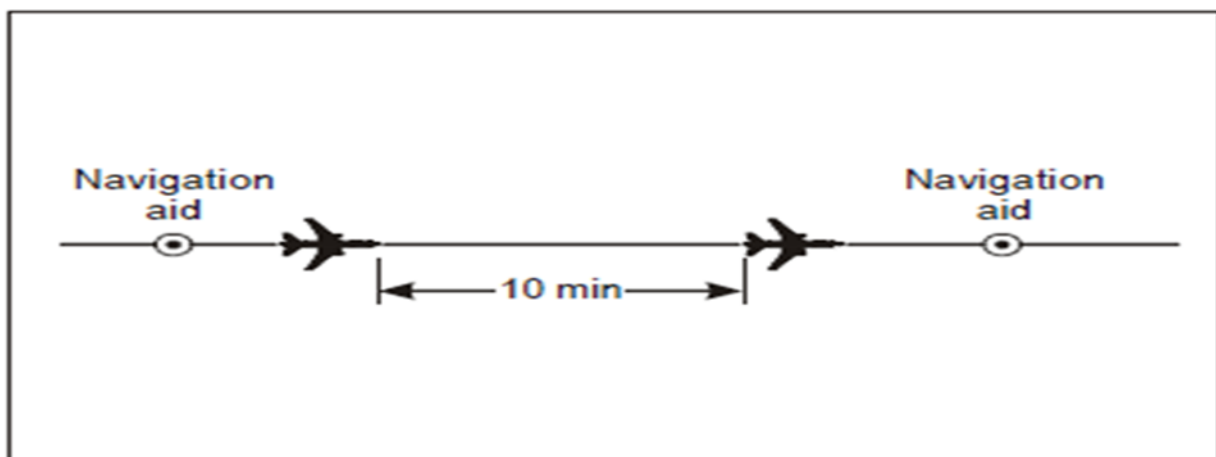

Figure 7: 10-minute separation between aircraft on the same track and same level

- (3) 5 minutes in the following cases, provided that in each case the preceding aircraft is maintaining a TAS of 37 km/h (20 kt) or more faster than the succeeding aircraft (see Figure 8)

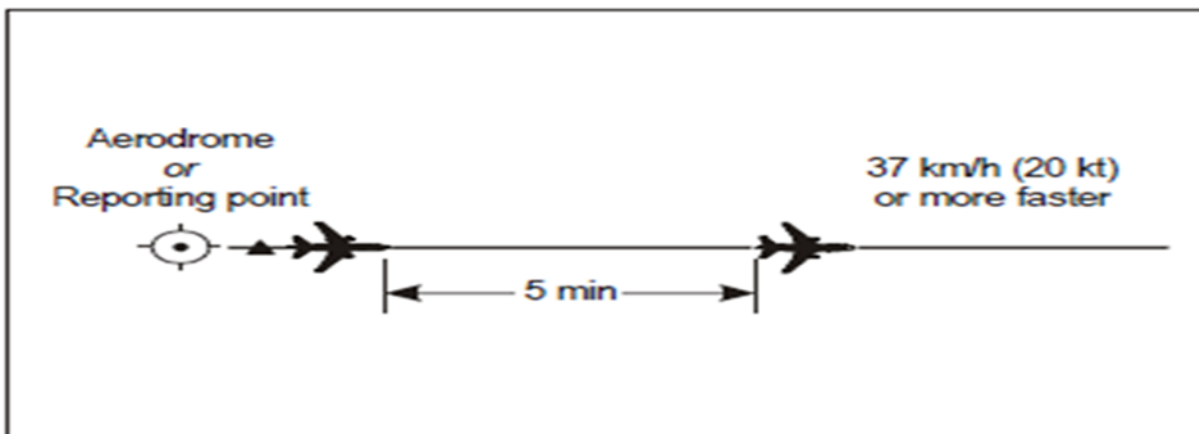

Figure 8: 5-minute separation between aircraft on the same track and same level

- (i) between aircraft that have departed from the same aerodrome;
 - (ii) between en-route aircraft that have reported over the same exact significant point;
 - (iii) between departing and en-route aircraft after the en-route aircraft has reported over a fix that it is so located in relation to the departure point as to ensure that 5-minute separation can be established at the point the departing aircraft will join the air route; or
- (4) 3 minutes in the cases listed under point (a)(3), provided that in each case the preceding aircraft is maintaining a TAS of 74 km/h (40 kt) or more faster than the succeeding aircraft (see Figure 9)

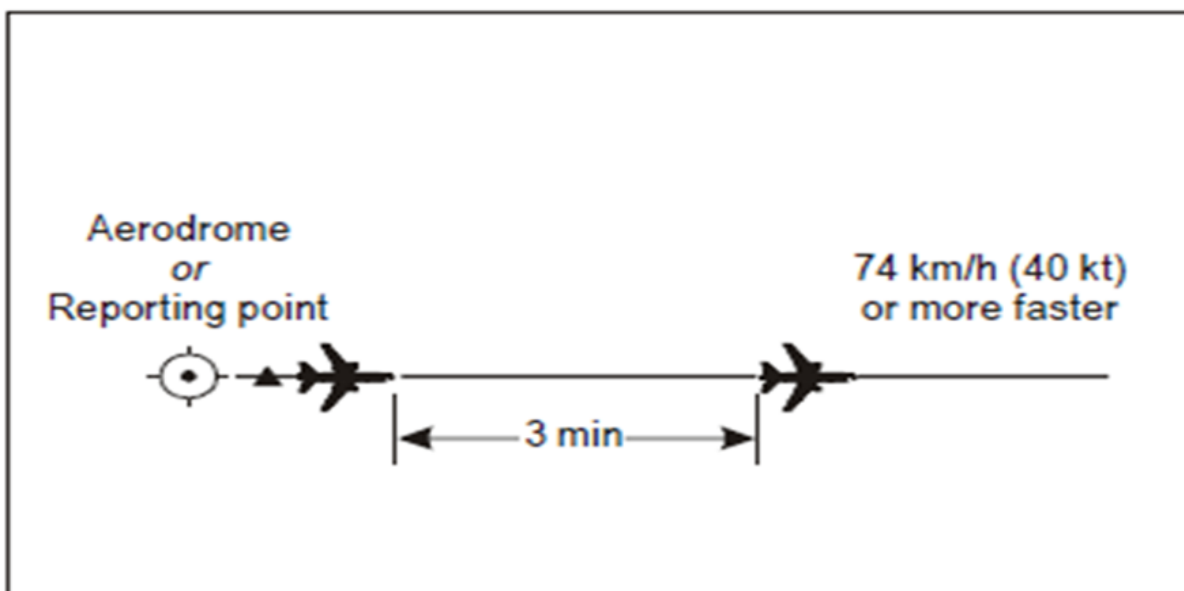

Figure 9: 3-minute separation between aircraft on the same track and same level

(b) Aircraft flying on crossing tracks

(1) 15 minutes at the point of intersection of the tracks (see Figure 10); or

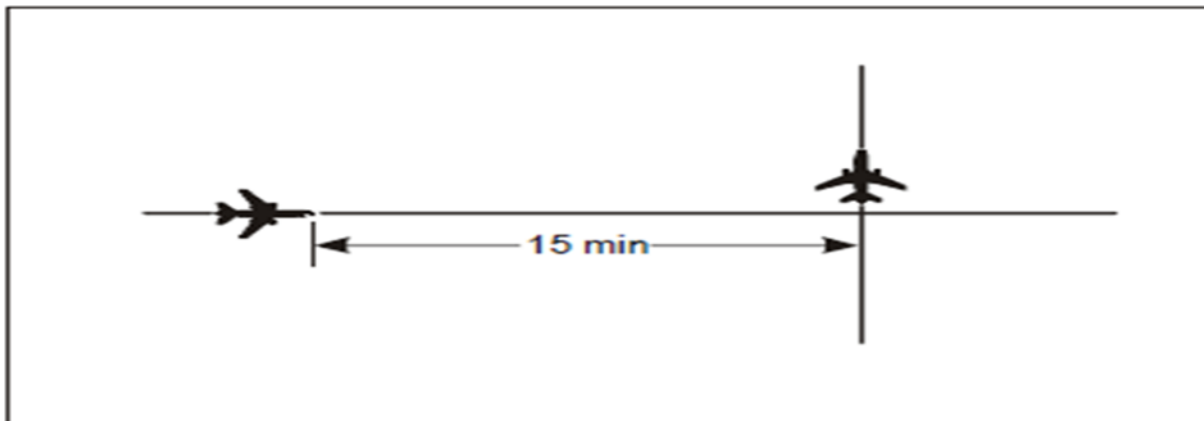

Figure 10: 15-minute separation between aircraft on crossing tracks and same level

(2) 10 minutes if navigation aids permit frequent determination of position and speed (see Figure 11).

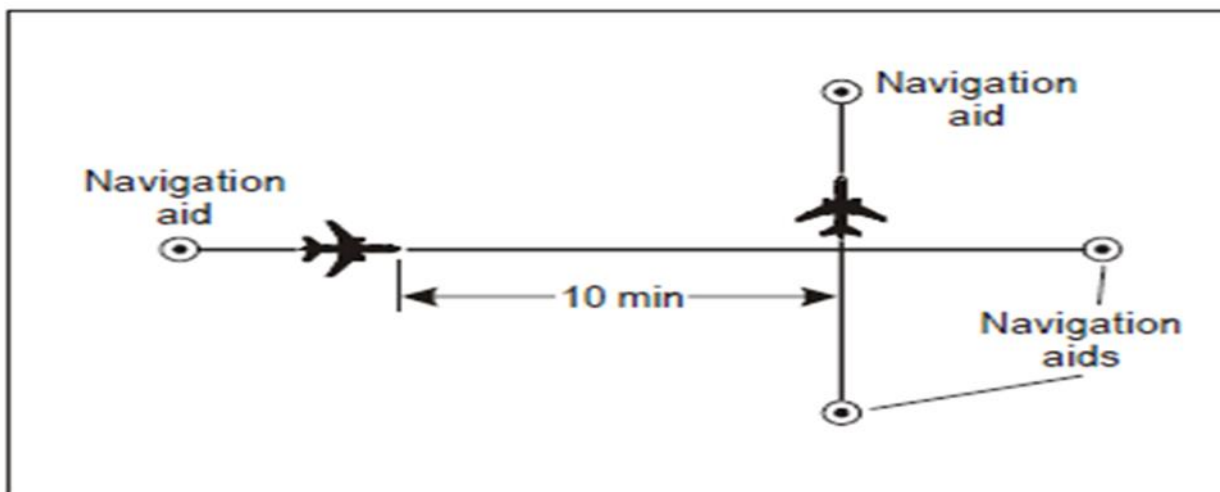

Figure 11: 10-minute separation between aircraft on crossing tracks and same level

AMC2 ATS.TR.210(c)(2)(i) Operation of air traffic control service

ED Decision 2020/008/R

PROCEDURAL SEPARATION — LONGITUDINAL SEPARATION MINIMA BASED ON TIME — AIRCRAFT CLIMBING OR DESCENDING

For aircraft climbing or descending, the longitudinal separation minima based on time should be one of the following:

a) Aircraft on the same track

When an aircraft will pass through the level of another aircraft on the same track, the following minimum longitudinal separation should be provided:

- (1) 15 minutes while vertical separation does not exist (see Figures 12 and 13); or

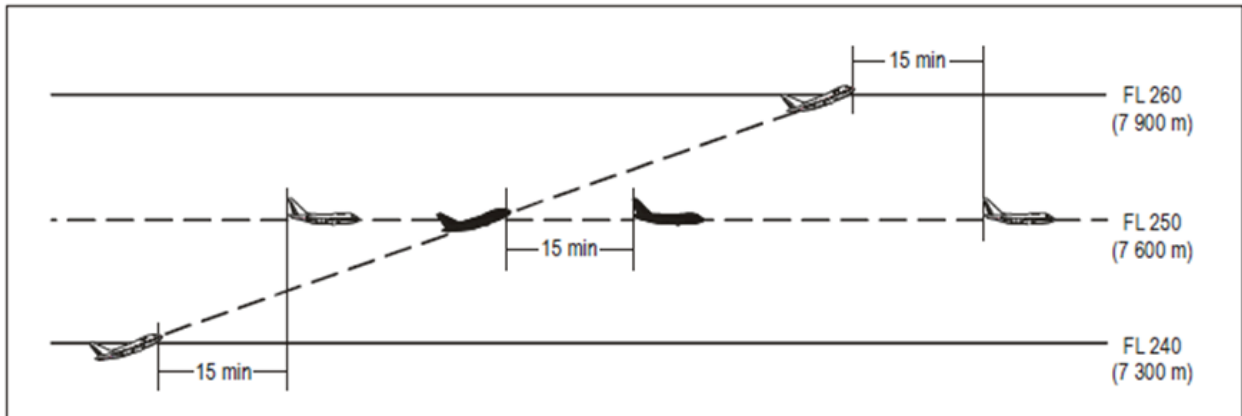

Figure 12: 15-minute separation between aircraft climbing and on the same track

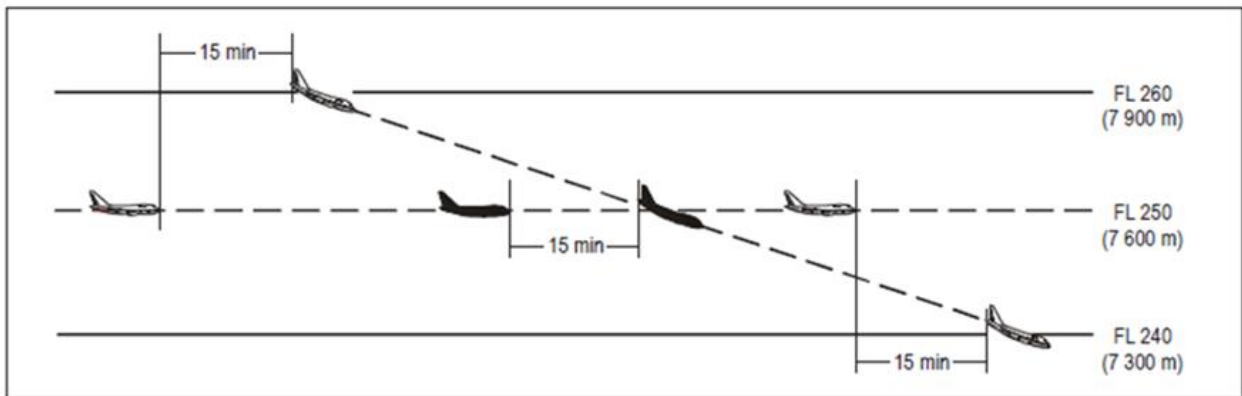

Figure 13: 15-minute separation between aircraft descending and on the same track

- (2) 10 minutes while vertical separation does not exist, provided that such separation is authorised only where ground-based navigation aids or GNSS permit frequent determination of position and speed (see Figures 14 and 15); or

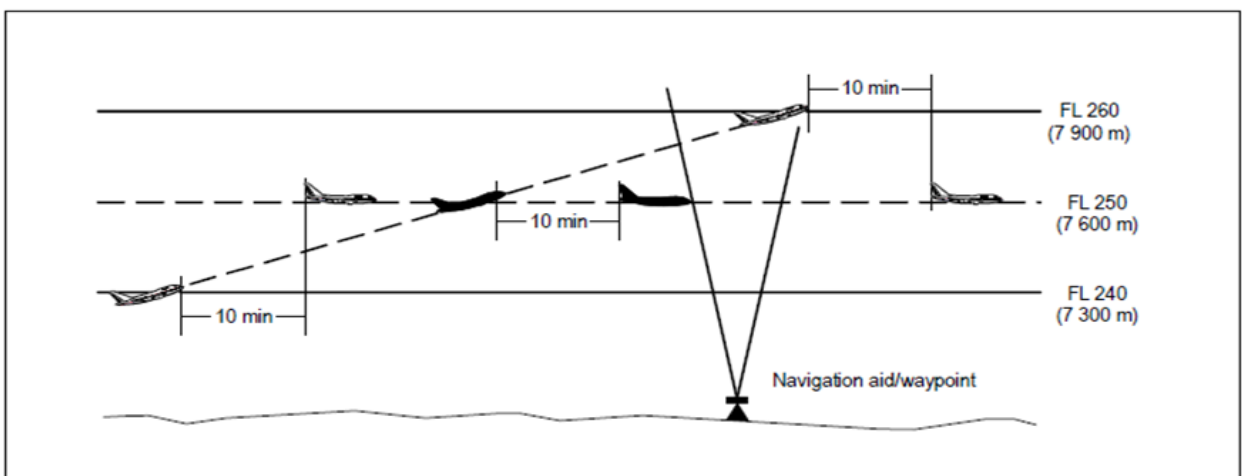

Figure 14: 10-minute separation between aircraft climbing and on the same track

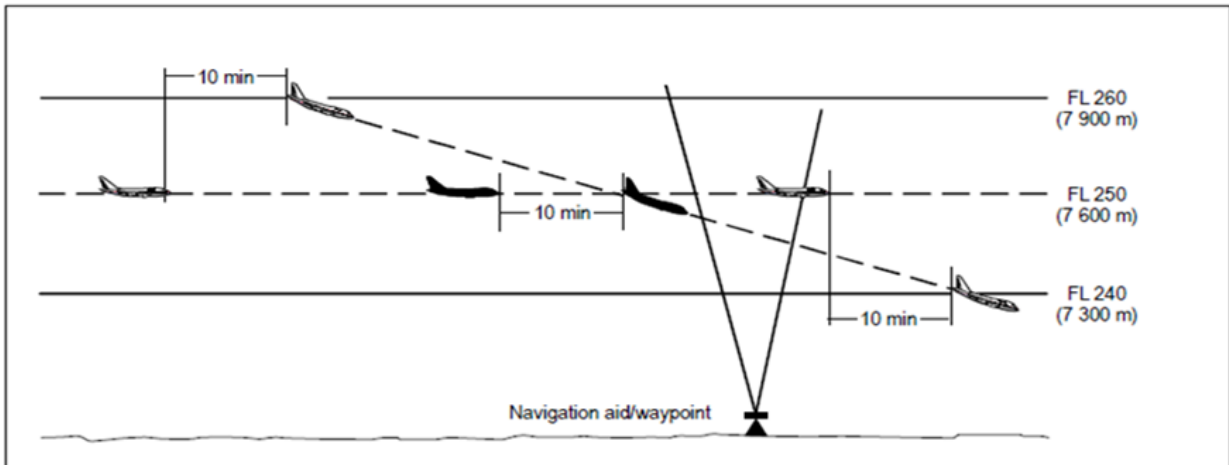

Figure 15: 10-minute separation between aircraft descending and on the same track

- (3) 5 minutes while vertical separation does not exist, provided that:
- (i) the level change is commenced within 10 minutes of the time the second aircraft has reported over a common point which should be derived from ground-based navigation aids or by GNSS; and
 - (ii) when issuing the clearance through third-party communication or CPDLC, a restriction should be added to the clearance to ensure that the 10-minute condition is satisfied (see Figures 16 and 17).

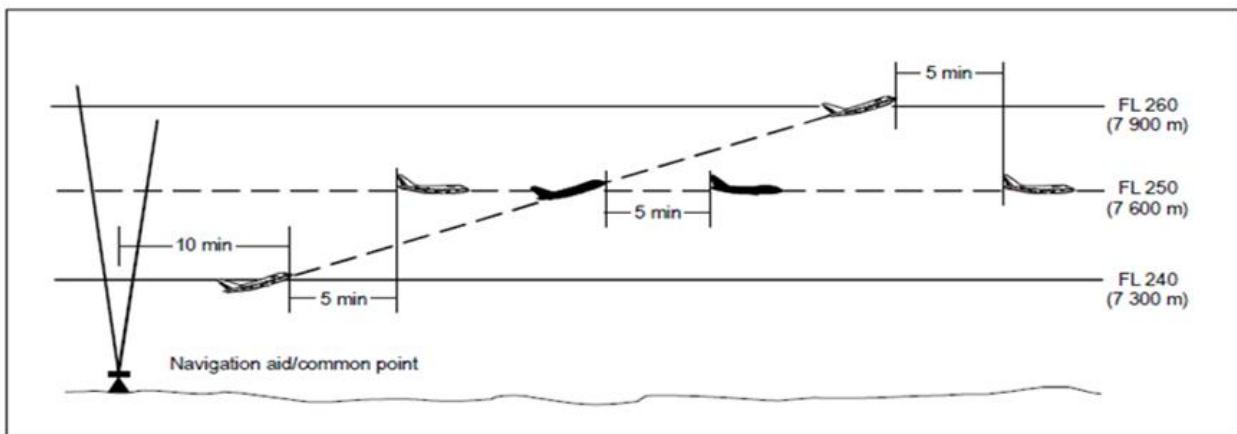

Figure 16: 5-minute separation between aircraft climbing and on the same track

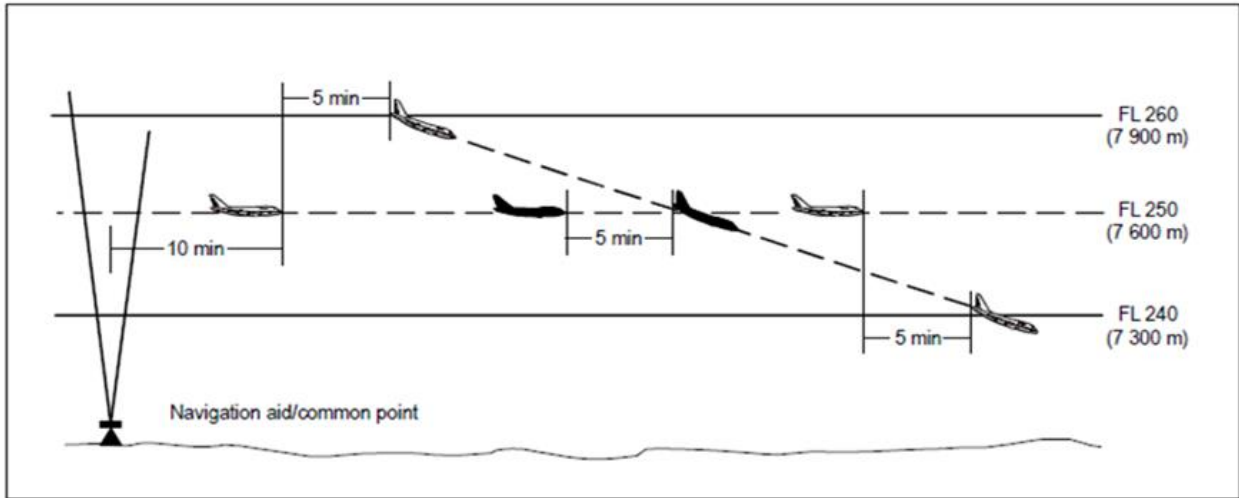

Figure 17: 5-minute separation between aircraft descending and on the same track

b) Aircraft on crossing tracks

- (1) 15 minutes while vertical separation does not exist (see Figures 18 and 19); or

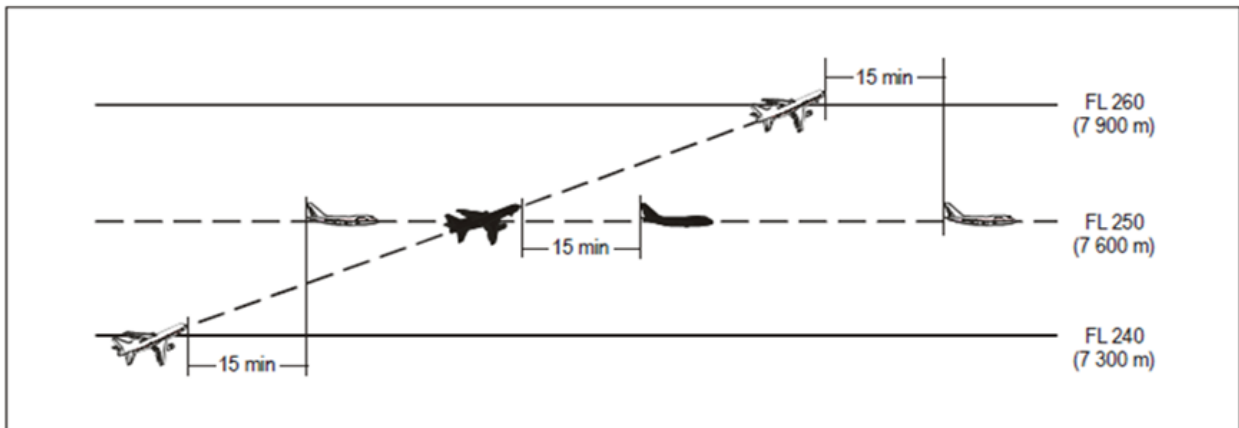

Figure 18: 15-minute separation between aircraft climbing and on crossing tracks

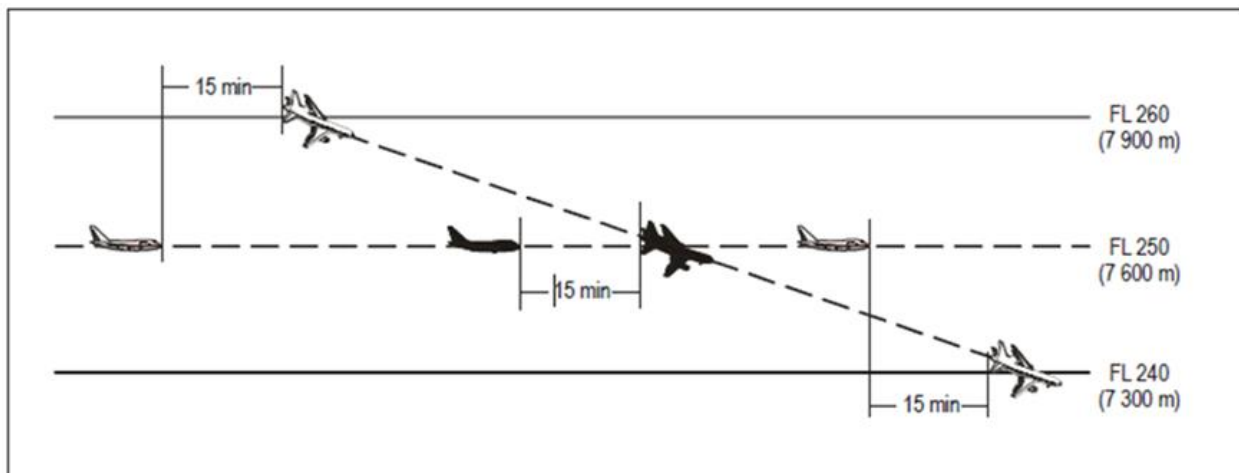

Figure 19: 15-minute separation between aircraft descending and on crossing tracks

- (2) 10 minutes while vertical separation does not exist if navigation aids permit frequent determination of position and speed (see Figures 20 and 21).

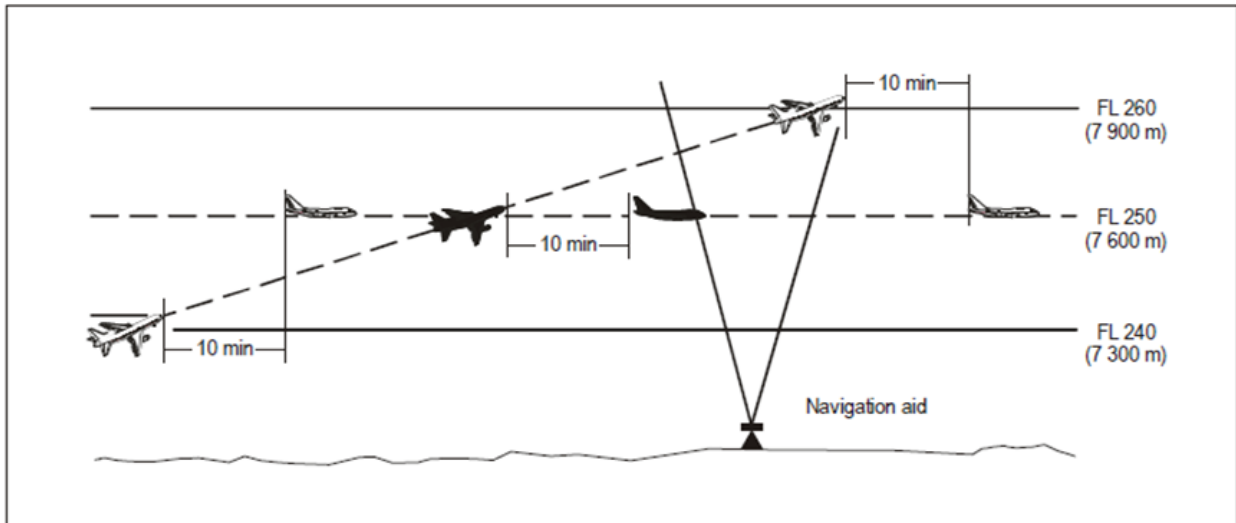

Figure 20: 10-minute separation between aircraft climbing and on crossing tracks

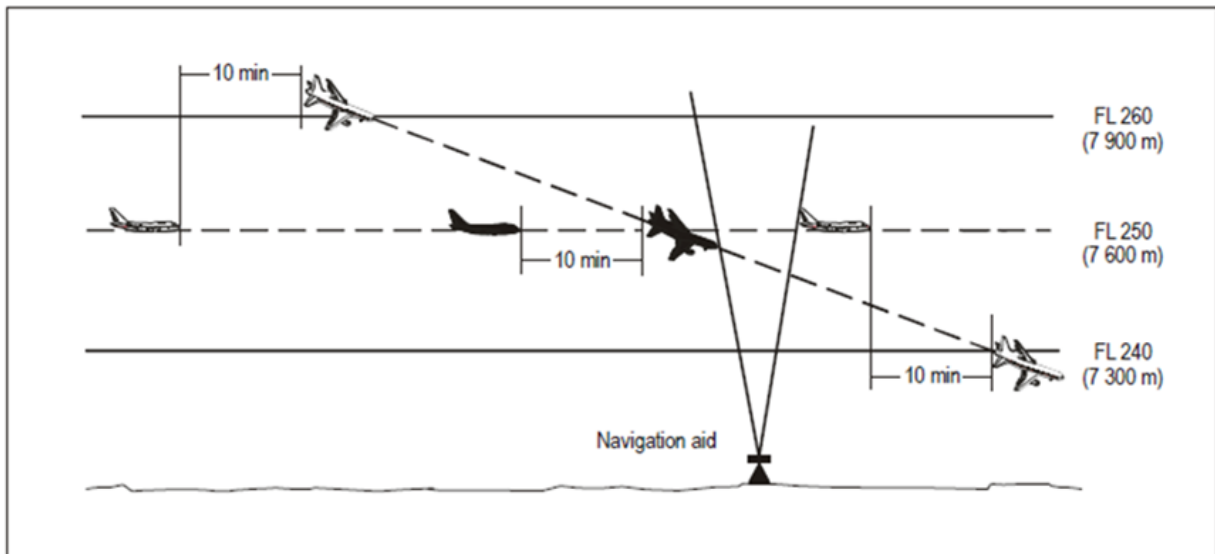

Figure 21: 10-minute separation between aircraft descending and on crossing tracks

- c) Aircraft on reciprocal tracks

Where lateral separation is not provided, vertical separation should be provided for at least 10 minutes prior to and after the time the aircraft are estimated to pass, or are estimated to have passed (see Figure 22). Provided it has been determined that the aircraft have passed each other, this minimum need not apply.

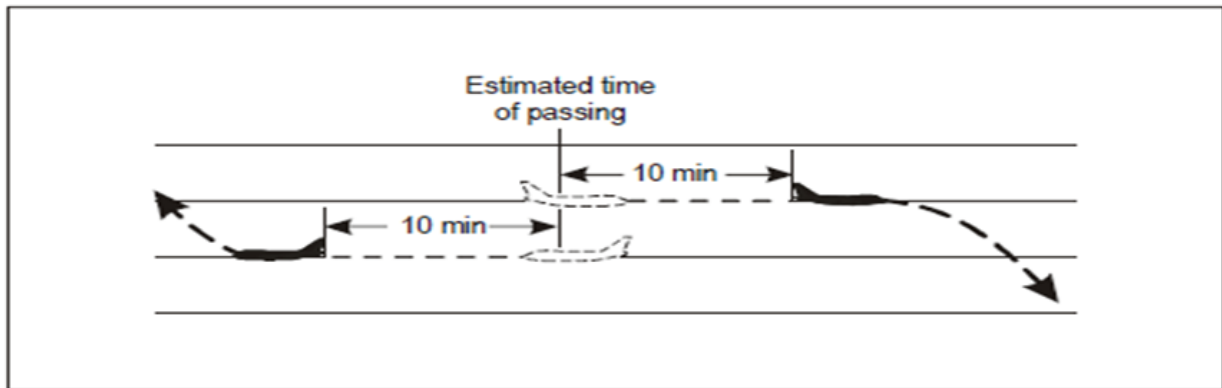

Figure 22: 10-minute separation between aircraft on reciprocal tracks

AMC3 ATS.TR.210(c)(2)(i) Operation of air traffic control service

ED Decision 2020/008/R

PROCEDURAL SEPARATION — LONGITUDINAL SEPARATION MINIMA BASED ON DISTANCE USING DISTANCE MEASURING EQUIPMENT (DME) AND/OR GNSS — AIRCRAFT AT THE SAME CRUISING LEVEL

Longitudinal separation minima based on distance using distance measuring equipment (DME) and/or GNSS should be established between aircraft at the same cruising level, as follows:

- (a) Aircraft on the same track
 - (1) 37 km (20 NM), provided:
 - (i) each aircraft utilises:
 - (A) the same 'on-track' DME station when both aircraft are utilising DME; or
 - (B) an 'on-track' DME station and a collocated waypoint when one aircraft is utilising DME and the other is utilising GNSS; or
 - (C) the same waypoint when both aircraft are utilising GNSS; and
 - (ii) separation is checked by obtaining simultaneous DME and/or GNSS readings from the aircraft at frequent intervals to ensure that the minimum will not be infringed (see Figure 23);

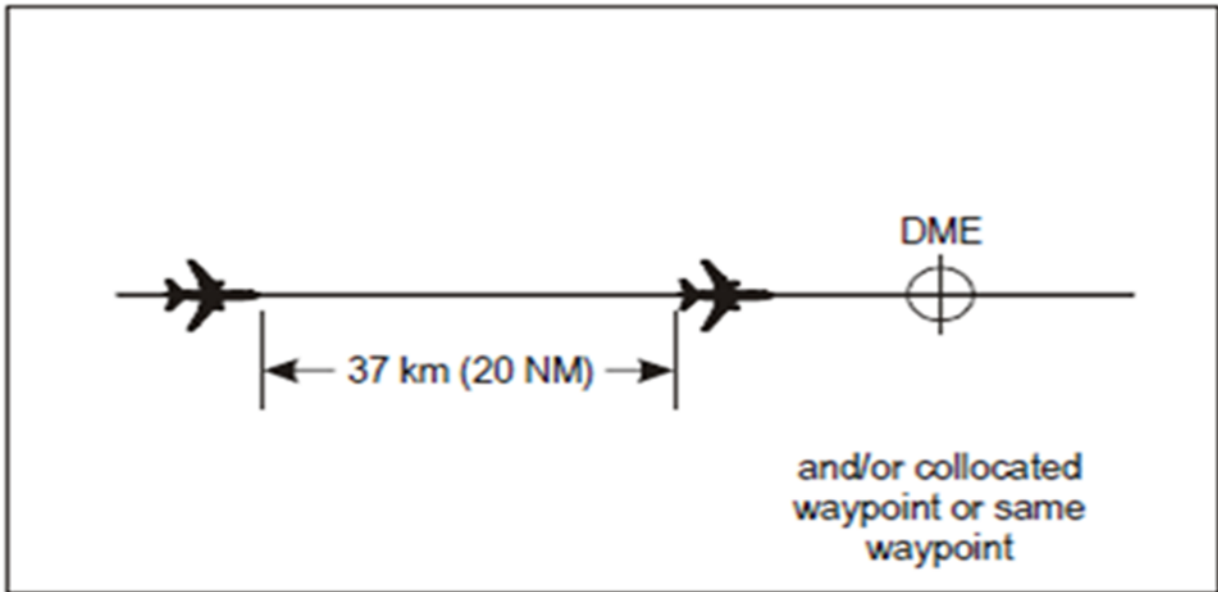

Figure 23: 37 km (20 NM) DME and/or GNSS-based separation between aircraft on the same track and same level

- (2) 19 km (10 NM), provided:
 - (i) the leading aircraft maintains a TAS of 37 km/h (20 kt) or more faster than the succeeding aircraft;
 - (ii) each aircraft utilises:
 - (A) the same ‘on-track’ DME station when both aircraft are utilising DME; or
 - (B) an ‘on-track’ DME station and a collocated waypoint when one aircraft is utilising DME and the other is utilising GNSS; or
 - (C) the same waypoint when both aircraft are utilising GNSS; and
 - (iii) separation is checked by obtaining simultaneous DME and/or GNSS readings from the aircraft at such intervals as are necessary to ensure that the minimum is established and will not be infringed (see Figure 24).

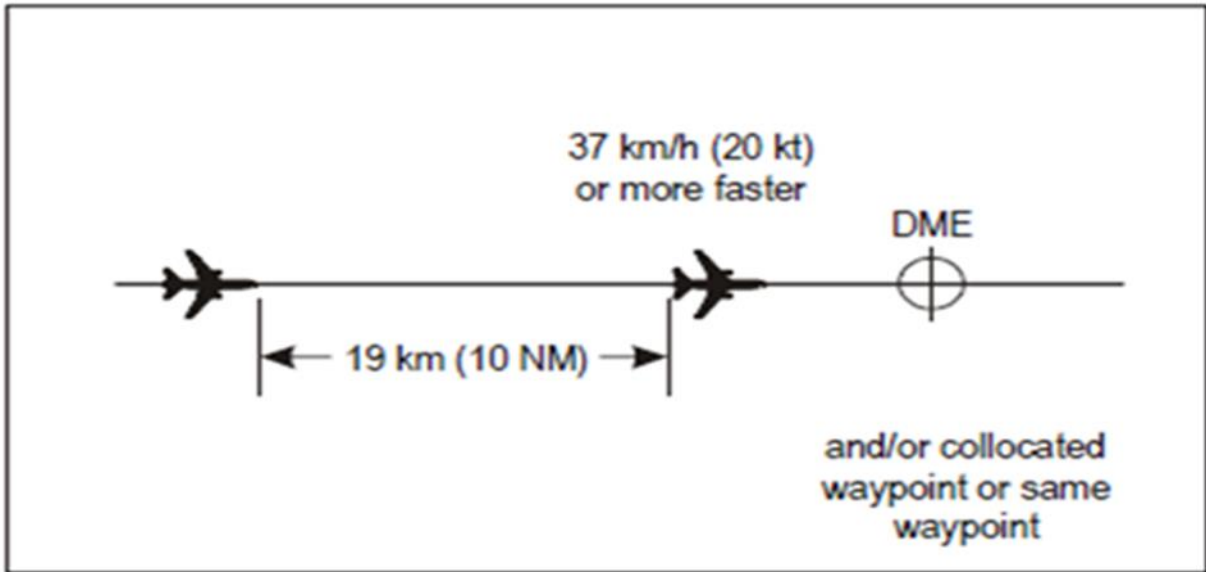

Figure 24: 19 km (10 NM) DME and/or GNSS-based separation between aircraft on the same track and same level

(b) Aircraft on crossing tracks

The longitudinal separation prescribed in point (a) should also apply, provided each aircraft reports distance from the DME station and/or collocated waypoint or same waypoint located at the crossing point of the tracks and that the relative angle between the tracks is less than 90 degrees (see Figures 25 and 26).

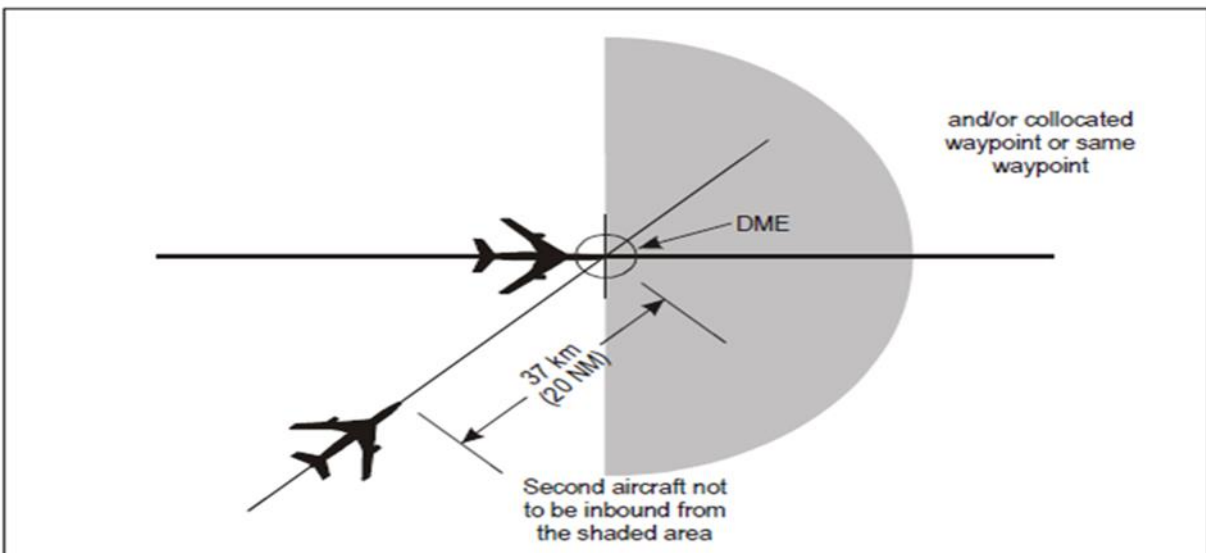

Figure 25: 37 km (20 NM) DME and/or GNSS-based separation between aircraft on crossing tracks and the same level

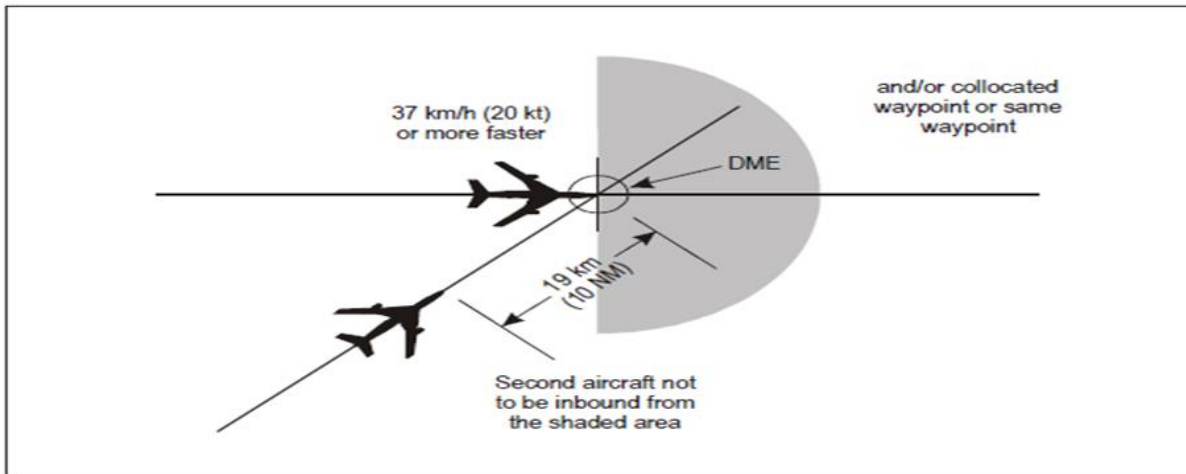

Figure 26: 19 km (10 NM) DME and/or GNSS-based separation between aircraft on crossing tracks and the same level

AMC4 ATS.TR.210(c)(2)(i) Operation of air traffic control service

ED Decision 2020/008/R

PROCEDURAL SEPARATION — LONGITUDINAL SEPARATION MINIMA BASED ON DISTANCE USING DISTANCE MEASURING EQUIPMENT (DME) AND/OR GNSS — AIRCRAFT CLIMBING OR DESCENDING

Longitudinal separation minima based on distance using distance measuring equipment (DME) AND/OR GNSS should be established between aircraft climbing or descending, as follows:

- (a) Aircraft on the same track
 - 19 km (10 NM) while vertical separation does not exist, provided:
 - (1) each aircraft utilises:
 - (i) the same ‘on-track’ DME station when both aircraft are utilising DME; or
 - (ii) an ‘on-track’ DME station and a collocated waypoint when one aircraft is utilising DME and the other is utilising GNSS; or
 - (iii) the same waypoint when both aircraft are utilising GNSS; and
 - (2) one aircraft maintains a level while vertical separation does not exist; and

- (3) separation is established by obtaining simultaneous DME and/or GNSS readings from the aircraft (see Figures 27 and 28).

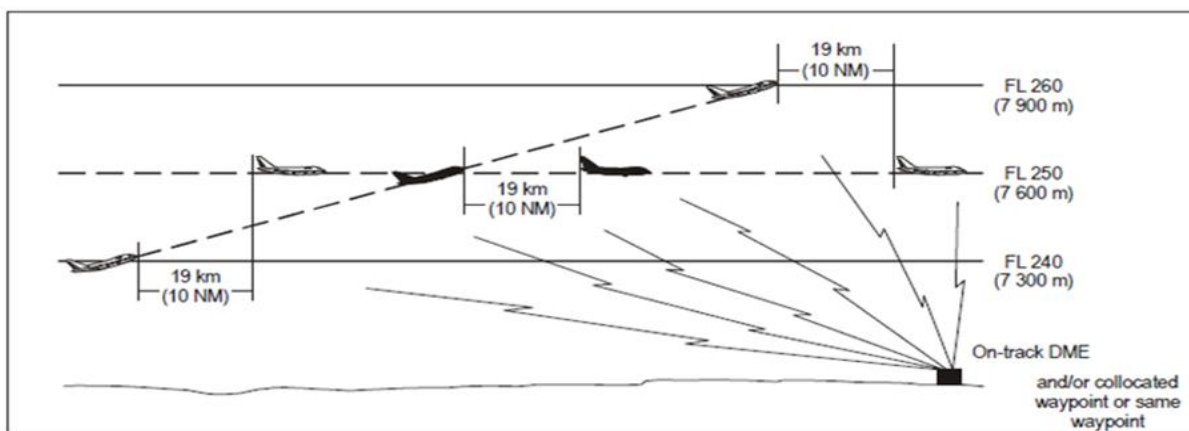

Figure 27: 19 km (10 NM) DME and/or GNSS-based separation between aircraft climbing and on the same track



Figure 28: 19 km (10 NM) DME and/or GNSS-based separation between aircraft descending and on the same track

- (b) Aircraft on reciprocal tracks

Aircraft utilising on-track DME and/or collocated waypoint or same waypoint may be cleared to climb or descend through the levels occupied by other aircraft utilising on-track DME and/or collocated waypoint or same waypoint, provided that it has been positively established that the aircraft have passed each other and are at least 10 NM apart, or such other value determined by the air traffic services provider and approved by the competent authority.

GM1 to AMC3 ATS.TR.210(c)(2)(i) and AMC4 ATS.TR.210(c)(2)(i) Operation of air traffic control service

ED Decision 2020/008/R

PROCEDURAL SEPARATION — LONGITUDINAL SEPARATION MINIMA BASED ON DISTANCE USING DISTANCE MEASURING EQUIPMENT (DME) AND/OR GNSS — APPLICATION

- (a) Where the term 'on track' is used in the provisions relating to the application of longitudinal separation minima using DME and/or GNSS, it means that the aircraft is flying either directly inbound to or directly outbound from the station/waypoint.
- (b) Separation should be established by maintaining not less than the specified distance(s) between aircraft positions as reported by reference to DME in conjunction with other appropriate navigation aids and/or GNSS. This type of separation should be applied between two aircraft using DME, or two aircraft using GNSS, or one aircraft using DME and one aircraft using GNSS. Direct controller-pilot VHF voice communication should be maintained while such separation is used.
- (c) For the purpose of applying GNSS-based separation minimum, a distance derived from an integrated navigation system incorporating GNSS input is regarded as equivalent to GNSS distance.
- (d) When applying these separation minima between any aircraft with area navigation capability, air traffic controllers should specifically request GNSS-derived distance.

AMC5 ATS.TR.210(c)(2)(i) Operation of air traffic control service

ED Decision 2020/008/R

PROCEDURAL SEPARATION — LONGITUDINAL SEPARATION MINIMA WITH MACH NUMBER TECHNIQUE BASED ON TIME

When the Mach number technique is applied and provided that:

- (a) the aircraft concerned have reported over the same common point and follow the same track or continuously diverging tracks until some other form of separation is provided; or
- (b) if the aircraft have not reported over the same common point and it is possible to ensure, by radar, ADS-B or other means, that the appropriate time interval will exist at the common point from which they either follow the same track or continuously diverging tracks, minimum longitudinal separation between turbojet aircraft on the same track, whether in level, climbing or descending flight should be:
 - (1) 10 minutes. In this case, the preceding aircraft should maintain a true Mach number equal to or greater than that maintained by the following aircraft; or
 - (2) between 9 and 5 minutes inclusive, provided that the preceding aircraft is maintaining a true Mach number greater than the following aircraft in accordance with the following:
 - (i) 9 minutes if the preceding aircraft is Mach 0.02 faster than the following aircraft;
 - (ii) 8 minutes if the preceding aircraft is Mach 0.03 faster than the following aircraft;
 - (iii) 7 minutes if the preceding aircraft is Mach 0.04 faster than the following aircraft;
 - (iv) 6 minutes if the preceding aircraft is Mach 0.05 faster than the following aircraft;
 - (v) 5 minutes if the preceding aircraft is Mach 0.06 faster than the following aircraft.

AMC6 ATS.TR.210(c)(2)(i) Operation of air traffic control service

ED Decision 2020/008/R

PROCEDURAL SEPARATION — LONGITUDINAL SEPARATION MINIMA WITH MACH NUMBER TECHNIQUE BASED ON DISTANCE USING RNAV

- (a) The air traffic controller should not apply RNAV distance-based separation minima after having received pilot advice indicating navigation equipment deterioration or failure.
- (b) A 150 km (80 NM) RNAV distance-based separation minimum with Mach number technique may be used on same-direction tracks in lieu of a 10-minute longitudinal separation minimum with Mach number technique, provided that:
 - (1) each aircraft reports its distance to or from the same 'on-track' common point;
 - (2) separation between aircraft at the same level is checked by obtaining simultaneous RNAV distance readings from the aircraft at frequent intervals to ensure that the minimum will not be infringed (see Figure 29);

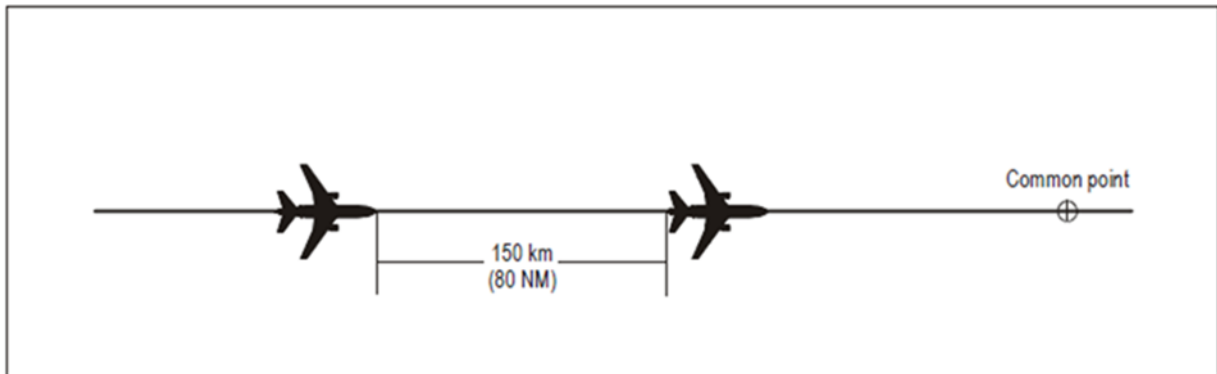

Figure 29: 150 km (80 NM) RNAV-based separation between aircraft at the same level

- (3) separation between aircraft climbing or descending is established by obtaining simultaneous RNAV distance readings from the aircraft (see Figures 30 and 31); and

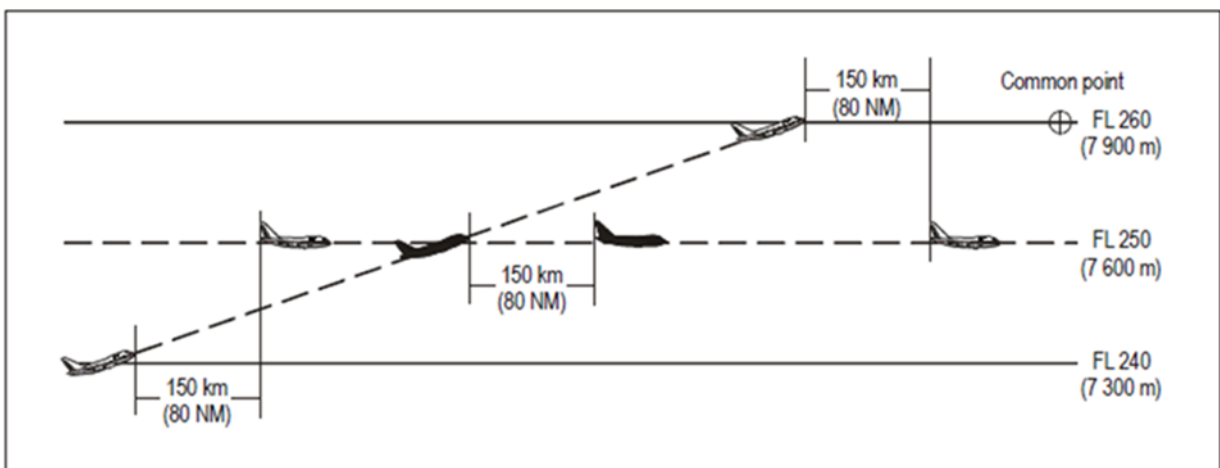

Figure 30: 150 km (80 NM) RNAV-based separation between aircraft climbing and on the same track

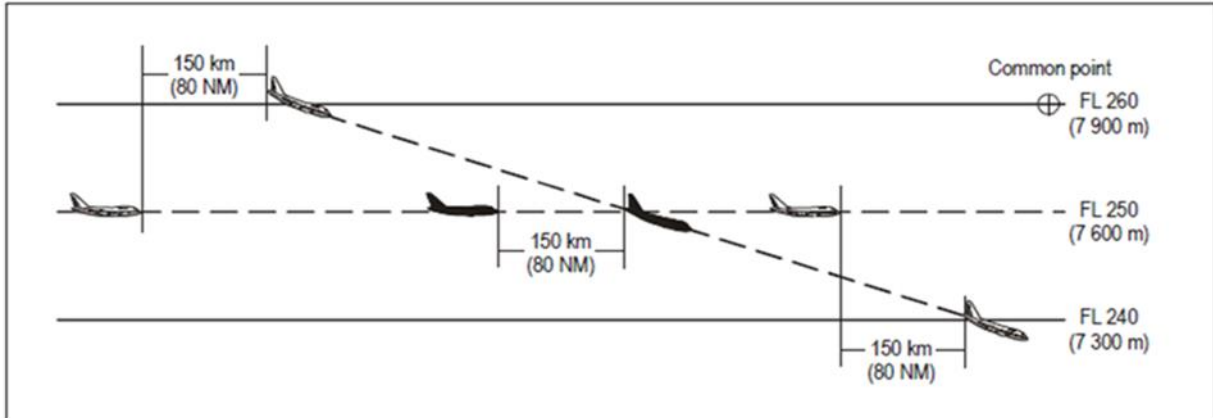

Figure 31: 150 km (80 NM) RNAV-based separation between aircraft descending and on the same track

- (4) in the case of aircraft climbing or descending, one aircraft maintains a level while vertical separation does not exist.
- (c) Aircraft on reciprocal tracks

Aircraft utilising RNAV may be cleared to climb or descend to or through the levels occupied by other aircraft utilising RNAV, provided it has been positively established by simultaneous RNAV distance readings to or from the same 'on-track' common point that the aircraft have passed each other and are at least 150 km (80 NM) apart (see Figure 32).

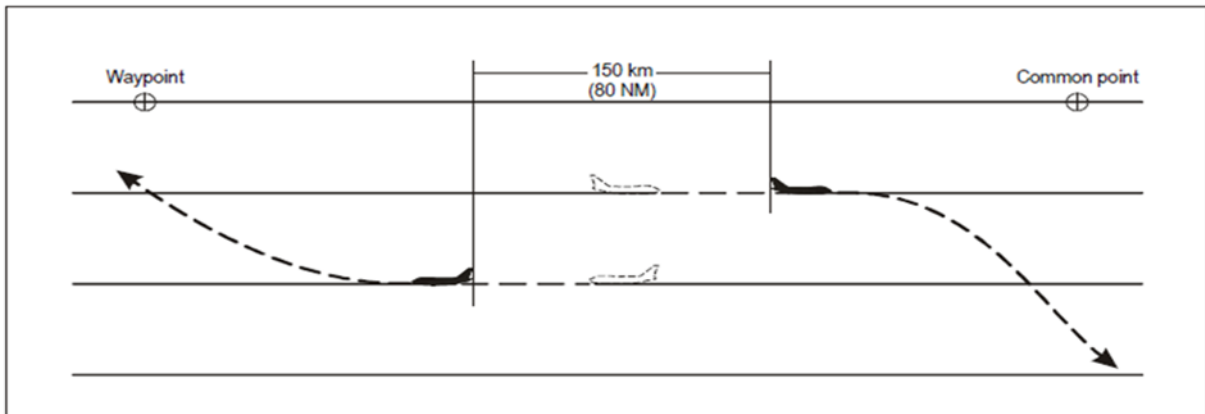

Figure 32: 150 km (80 NM) RNAV-based separation between aircraft on reciprocal tracks

GM1 to AMC5 ATS.TR.210(c)(2)(i) and AMC6 ATS.TR.210(c)(2)(i) Operation of air traffic control service

ED Decision 2020/008/R

PROCEDURAL SEPARATION — LONGITUDINAL SEPARATION MINIMA WITH MACH NUMBER TECHNIQUE

Guidance on the application of the Mach number technique for separation of subsonic aircraft is available in ICAO Doc 9426 'Air Traffic Services Planning Manual'.

GM1 to AMC6 ATS.TR.210(c)(2)(i) Operation of air traffic control service

ED Decision 2020/008/R

LONGITUDINAL SEPARATION MINIMA WITH MACH NUMBER TECHNIQUE BASED ON DISTANCE USING RNAV — APPLICATION

- (a) Separation should be established by maintaining not less than the specified distance between aircraft positions as reported by reference to RNAV equipment. Direct controller-pilot communications should be maintained, while such separation is used. Where high-frequency or general-purpose extended-range VHF air-ground communication channels are used for area control service and are worked by air-ground communicators, suitable arrangements should be made to permit direct controller-pilot communications, or monitoring by the air traffic controller of all air-ground communications.
- (b) To assist pilots to readily provide the required RNAV distance information, such position reports should, wherever possible, be referenced to a common waypoint ahead of both aircraft.
- (c) RNAV distance-based separation may be applied between RNAV-equipped aircraft when operating on designated RNAV routes or on ATS routes defined by VOR.
- (d) To facilitate application of the procedure where a considerable change of level is involved, a descending aircraft may be cleared to some convenient level above the lower aircraft, or a climbing aircraft to some convenient level below the higher aircraft, to permit a further check on the separation that will be obtained while vertical separation does not exist.

AMC7 ATS.TR.210(c)(2)(i) Operation of air traffic control service

ED Decision 2020/008/R

RUNWAY SEPARATION MINIMA BETWEEN DEPARTING AIRCRAFT AND OTHER AIRCRAFT USING THE SAME RUNWAY

Except as provided in [AMC9 ATS.TR.210\(c\)\(2\)\(i\)](#) as regards reduced runway separation minima between aircraft using the same runway, and in [ATS.TR.220](#) as regards time-based wake turbulence separation minima, the aerodrome control tower should not permit a departing aircraft to commence take-off until:

- (a) the preceding departing aircraft has crossed the end of the runway-in-use; or
- (b) the preceding departing aircraft has started a turn; or
- (c) all preceding landing aircraft are clear of the runway-in-use (see Figure 33).

Position limits to be reached by a landed aircraft (A) or a departing aircraft (B or C) before an arriving aircraft may be cleared to cross the threshold of the runway-in-use or a departing aircraft may be cleared to take off, unless otherwise prescribed.

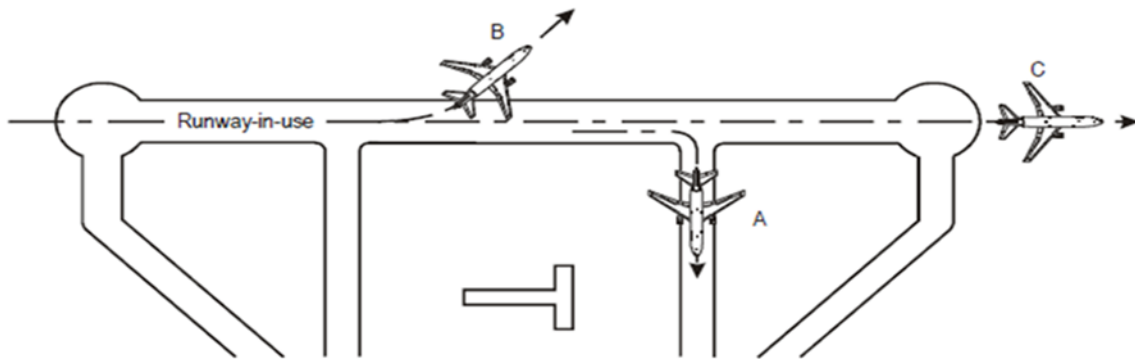

Figure 33: Separation between departing and arriving aircraft

AMC8 ATS.TR.210(c)(2)(i) Operation of air traffic control service

ED Decision 2020/008/R

RUNWAY SEPARATION OF LANDING AIRCRAFT AND PRECEDING LANDING AND DEPARTING AIRCRAFT USING THE SAME RUNWAY

Except as provided [AMC9 ATS.TR.210\(c\)\(2\)\(i\)](#) as regards reduced runway separation minima between aircraft using the same runway, and in [ATS.TR.220](#) as regards time-based wake turbulence separation minima, the aerodrome control tower should not permit a landing aircraft to cross the runway threshold on its final approach until:

- (a) the preceding departing aircraft has crossed the end of the runway-in-use; or
- (b) the preceding departing aircraft has started a turn; or
- (c) all preceding landing aircraft are clear of the runway-in-use (see Figure 33).

AMC9 ATS.TR.210(c)(2)(i) Operation of air traffic control service

ED Decision 2020/008/R

REDUCED RUNWAY SEPARATION MINIMA BETWEEN AIRCRAFT USING THE SAME RUNWAY

- (a) The air traffic services provider may prescribe lower minima than those established in [AMC7 ATS.TR.210\(c\)\(2\)\(i\)](#) concerning separation of departing aircraft, and in [AMC8 ATS.TR.210\(c\)\(2\)\(i\)](#) concerning separation of landing aircraft and preceding landing and departing aircraft using the same runway, after consultation with the operators. The safety assessment to be performed in support of the application of reduced separation minima should be carried out for each runway for which the reduced minima are intended, taking into account factors such as:
 - (1) runway length;
 - (2) aerodrome layout; and
 - (3) types/categories of aircraft involved.
- (b) Reduced runway separation minima should only be applied during the hours of daylight from 30 minutes after local sunrise to 30 minutes before local sunset.

- (c) For the purpose of reduced runway separation, aircraft should be classified as follows:
- (1) Category 1 aircraft: single-engine propeller aircraft with a maximum certificated take-off mass (MCTOM) of 2 000 kg or less;
 - (2) Category 2 aircraft: single-engine propeller aircraft with a maximum certificated take-off mass of more than 2 000 kg but less than 7 000 kg; and twin-engine propeller aircraft with a maximum certificated take-off mass of less than 7 000 kg; and
 - (3) Category 3 aircraft: all other aircraft.
- (d) Reduced runway separation minima should not apply between a departing aircraft and a preceding landing aircraft.
- (e) Reduced runway separation minima should be subject to the following conditions:
- (1) wake turbulence separation minima should be applied;
 - (2) visibility should be at least 5 km and ceiling shall not be lower than 300 m (1 000 ft);
 - (3) tailwind component should not exceed 5 kt;
 - (4) there should be available means, such as suitable landmarks, to assist the air traffic controller in assessing the distances between aircraft. A surface movement ATS surveillance system that provides the air traffic controller with position information on aircraft may be utilised, provided that approval for operational use of such equipment includes a safety assessment to ensure that all requisite operational and performance requirements are met;
 - (5) minimum separation continues to exist between two departing aircraft immediately after take-off of the second aircraft;
 - (6) traffic information should be provided to the flight crew of the succeeding aircraft concerned; and
 - (7) the braking action should not be adversely affected by runway contaminants such as ice, slush, snow and water.
- (f) Reduced runway separation minima which may be applied at an aerodrome should be determined for each separate runway. The separation to be applied should in no case be less than the following minima:
- (1) landing aircraft:
 - (i) a succeeding landing Category 1 aircraft may cross the runway threshold when the preceding aircraft is a Category 1 or 2 aircraft which either:
 - (A) has landed and has passed a point at least 600 m from the threshold of the runway, is in motion and will vacate the runway without backtracking; or
 - (B) is airborne and has passed a point at least 600 m from the threshold of the runway;
 - (ii) a succeeding landing Category 2 aircraft may cross the runway threshold when the preceding aircraft is a Category 1 or 2 aircraft which either:
 - (A) has landed and has passed a point at least 1 500 m from the threshold of the runway, is in motion and will vacate the runway without backtracking; or

- (B) is airborne and has passed a point at least 1 500 m from the threshold of the runway;
- (iii) a succeeding landing aircraft may cross the runway threshold when a preceding Category 3 aircraft:
 - (A) has landed and has passed a point at least 2 400 m from the threshold of the runway, is in motion and will vacate the runway without backtracking; or
 - (B) is airborne and has passed a point at least 2 400 m from the threshold of the runway;
- (2) departing aircraft:
 - (i) a Category 1 aircraft may be cleared for take-off when the preceding departing aircraft is a Category 1 or 2 aircraft which is airborne and has passed a point at least 600 m from the position of the succeeding aircraft;
 - (ii) a Category 2 aircraft may be cleared for take-off when the preceding departing aircraft is a Category 1 or 2 aircraft which is airborne and has passed a point at least 1 500 m from the position of the succeeding aircraft; and
 - (iii) an aircraft may be cleared for take-off when a preceding departing Category 3 aircraft is airborne and has passed a point at least 2 400 m from the position of the succeeding aircraft.

AMC10 ATS.TR.210(c)(2)(i) Operation of air traffic control service

ED Decision 2020/008/R

PROCEDURAL CONTROL — MINIMUM SEPARATION BETWEEN DEPARTING AIRCRAFT

- (a) The aerodrome air traffic controller should apply a 1-minute separation if aircraft are to fly on tracks diverging by at least 45 degrees immediately after take-off so that lateral separation is provided (see Figure 34).
- (b) When:
 - (1) aircraft are using parallel runways; or
 - (2) in a context of operations on diverging runways which do not cross, the pilot has accepted a take-off direction which is not into the wind, in accordance with the procedure described in point (b) of [GM1 ATS.TR.260](#),

this minimum may be reduced, provided instructions covering the procedure have been established by the air traffic services provider and approved by the competent authority and lateral separation is effected immediately after take-off.

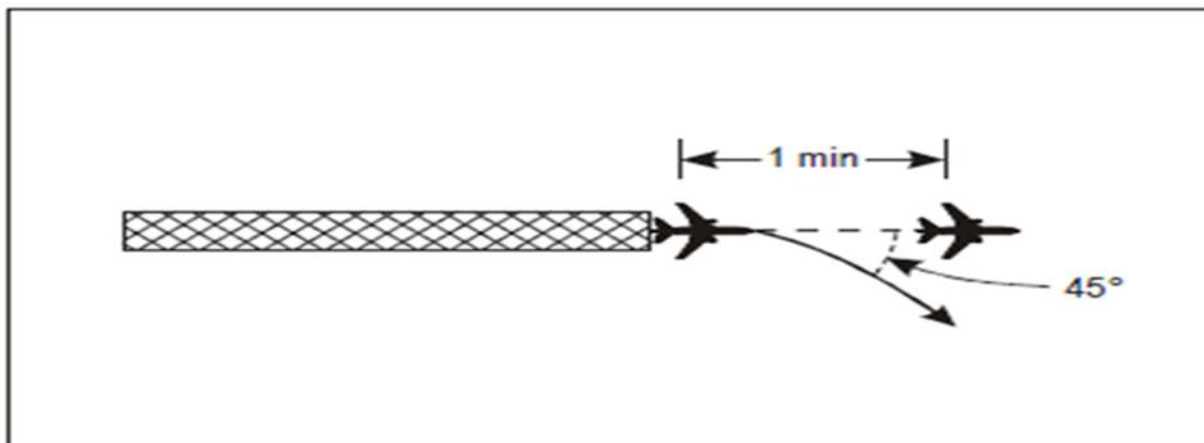

Figure 34: 1-minute separation between departing aircraft following tracks diverging by at least 45 degrees

- (c) The air traffic controller should apply a 2-minute separation between take-offs when the preceding aircraft is 74 km/h (40 kt) or more faster than the succeeding aircraft and both aircraft will follow the same track (see Figure 35).

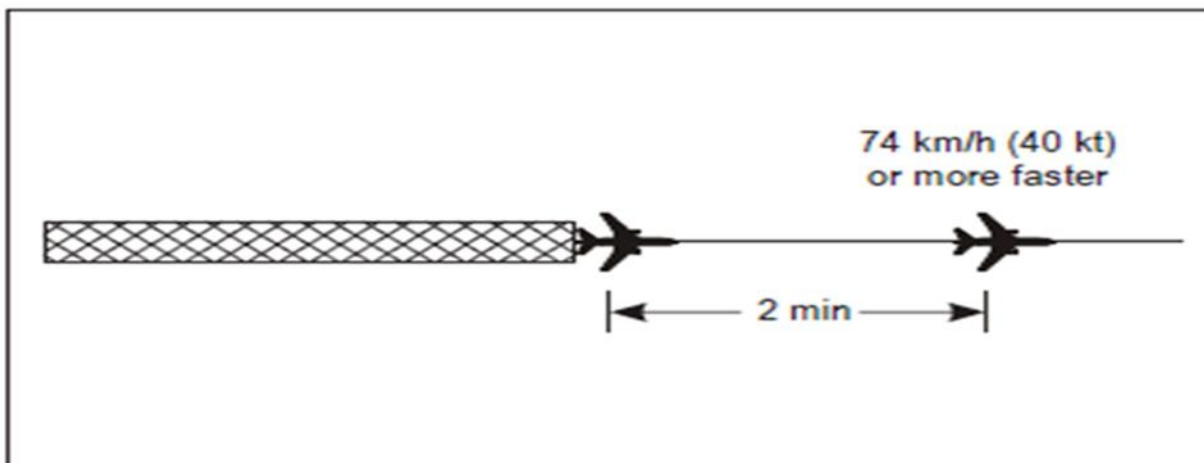

Figure 35: 2-minute separation between aircraft following the same track

- (d) The air traffic controller should apply a 5-minute separation while vertical separation does not exist if a departing aircraft will be flown through the level of a preceding departing aircraft and both aircraft propose to follow the same track (see Figure 36). The air traffic controller should take action to ensure that the 5-minute separation will be maintained or increased while vertical separation does not exist.

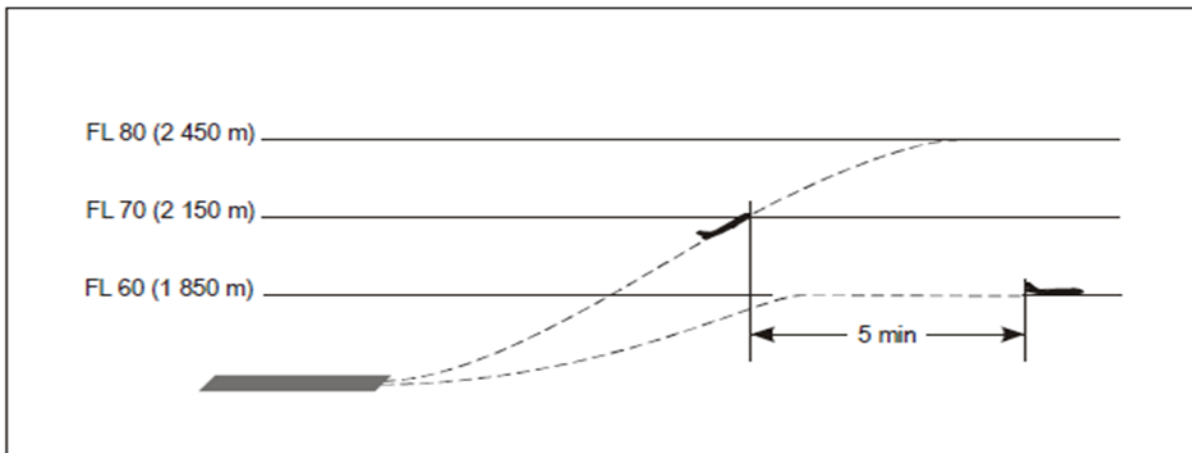

Figure 36: 5-minute separation of departing aircraft following the same track

AMC11 ATS.TR.210(c)(2)(i) Operation of air traffic control service

ED Decision 2020/008/R

PROCEDURAL CONTROL — SEPARATION OF DEPARTING AIRCRAFT FROM ARRIVING AIRCRAFT

The following separation should be applied when take-off clearance is based on the position of an arriving aircraft:

- (a) If an arriving aircraft is making a complete instrument approach, a departing aircraft may take off:
 - (1) in any direction until an arriving aircraft has started its procedure turn or base turn leading to final approach;
 - (2) in a direction which is different by at least 45 degrees from the reciprocal of the direction of approach after the arriving aircraft has started procedure turn or base turn leading to final approach, provided that the take-off will be made at least 3 minutes before the arriving aircraft is estimated to be over the beginning of the instrument runway (see Figure 37).

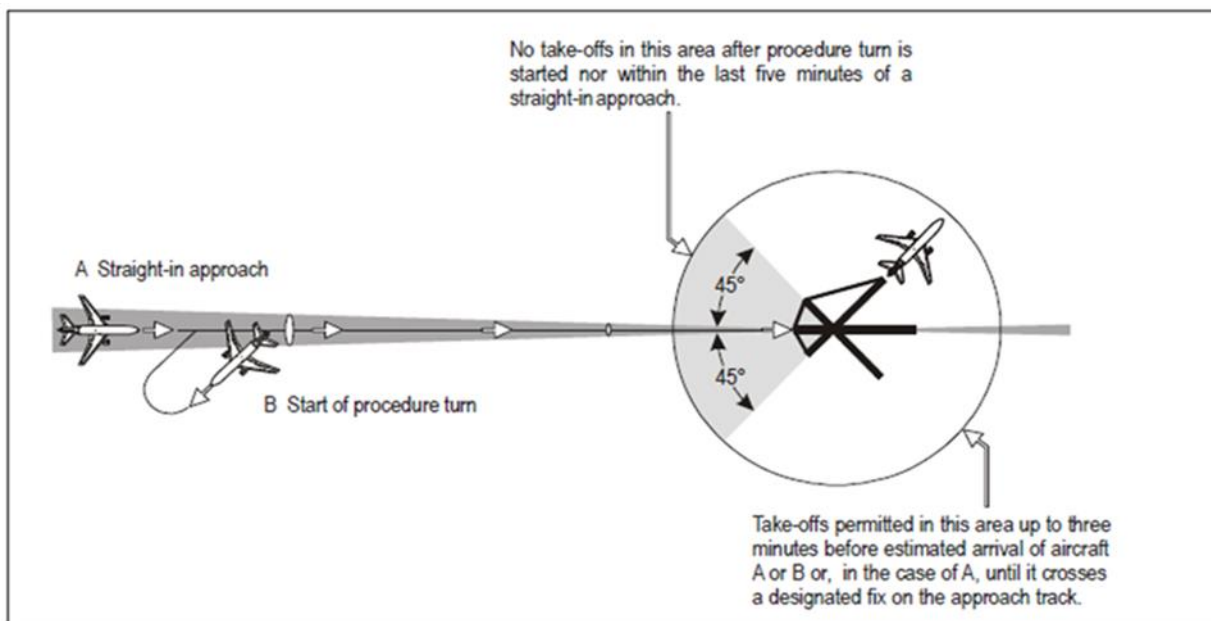

Figure 37: Separation of departing aircraft from arriving aircraft

- (b) If an arriving aircraft is making a straight-in approach, a departing aircraft may take off:
- (1) in any direction until 5 minutes before the arriving aircraft is estimated to be over the instrument runway;
 - (2) in a direction which is different by at least 45 degrees from the reciprocal of the direction of approach of the arriving aircraft:
 - (i) until 3 minutes before the arriving aircraft is estimated to be over the beginning of the instrument runway (see Figure 37); or
 - (ii) before the arriving aircraft crosses a designated fix on the approach track; the location of such fix should be determined by the air traffic services provider after consultation with the operators, and approved by the competent authority.

AMC1 ATS.TR.210(c)(2)(ii) Operation of air traffic control service

ED Decision 2020/008/R

PROCEDURAL CONTROL — LATERAL SEPARATION CRITERIA AND MINIMA

Lateral separation should be applied by one of the following means:

- (a) By reference to the same or different geographic locations

By position reports which positively indicate that the aircraft are over different geographic locations as determined visually or by reference to a navigation aid (see Figure 38).

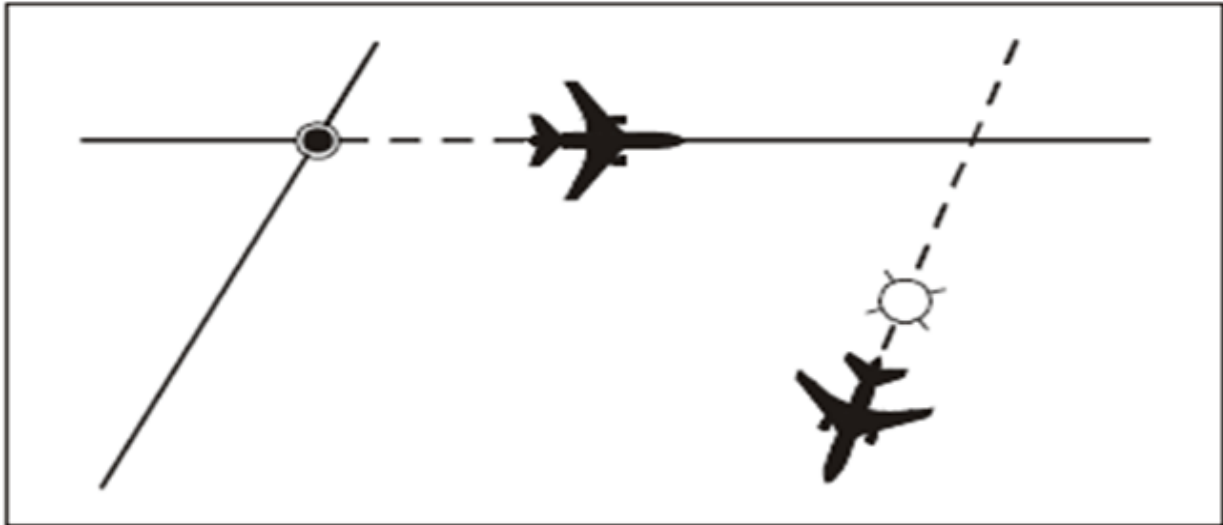

Figure 38: Using same or different geographic locations

- (b) By use of NDB, VOR or GNSS on intersecting tracks or ATS routes

By requiring aircraft to fly on specified tracks which are separated by a minimum amount appropriate to the navigation aid employed. Lateral separation between two aircraft exists when:

- (1) (VOR) both aircraft are established on radials diverging by at least 15 degrees and at least one aircraft is at a distance of 28 km (15 NM) or more from the facility (see Figure 39);

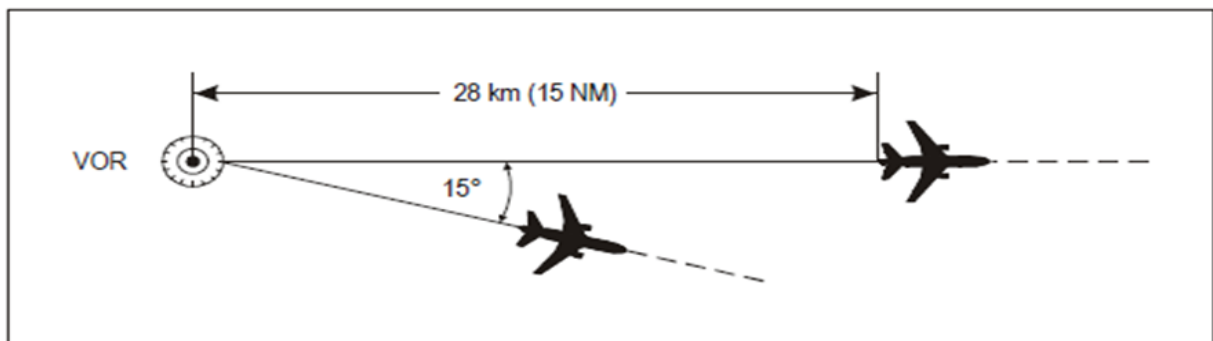

Figure 39: Separation using the same VOR

- (2) (NDB) both aircraft are established on tracks to or from the NDB which are diverging by at least 30 degrees and at least one aircraft is at a distance of 28 km (15 NM) or more from the facility (see Figure 40);

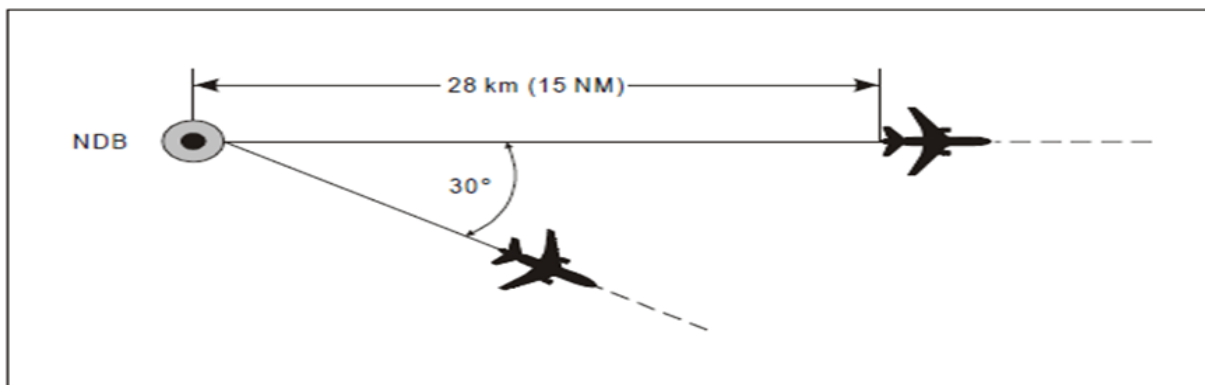

Figure 40: Separation using the same NDB

- (3) (GNSS/GNSS) each aircraft is confirmed to be established on a track with zero offset between two waypoints and at least one aircraft is at a minimum distance from a common point as specified in Table 1 below; or
- (4) (VOR/GNSS) the aircraft using VOR is established on a radial to or from the VOR and the other aircraft using GNSS is confirmed to be established on a track with zero offset between two waypoints and at least one aircraft is at a minimum distance from a common point as specified in the table below.

	Aircraft 1: VOR or GNSS Aircraft 2: GNSS	
Angular difference between tracks measured at the common point (degrees)	FL010-FL090 Distance from a common point	FL200-FL600 Distance from a common point
15-135	27.8 km (15 NM)	43 km (23 NM)
The distances in the table are ground distances. States must take into account the distance (slant range) from the source of a DME signal to the receiving antenna when DME is being utilised to provide range information.		

- (c) By use of different navigation aids or methods
Lateral separation between aircraft using different navigation aids, or when one aircraft is using RNAV equipment, should be established by ensuring that the derived protected airspaces for the navigation aid(s) or RNP do not overlap.
- (d) Lateral separation of aircraft on published instrument flight procedures for arrivals and departures
Lateral separation of departing and/or arriving aircraft, using instrument flight procedures, will exist where:
 - (1) the distance between any combination of RNAV 1 with RNAV 1, or RNP 1, RNP APCH or RNP AR APCH tracks is not less than 13 km (7 NM); or
 - (2) the distance between any combination of RNP 1, RNP APCH or RNP AR APCH tracks is not less than 9.3 km (5 NM); or
 - (3) the protected areas of tracks designed using obstacle clearance criteria do not overlap and provided operational error is considered.

- (e) RNAV operations where RNP is specified on parallel tracks or ATS routes

Within designated airspace or on designated routes, where RNP is specified, lateral separation between RNAV-equipped aircraft may be obtained by requiring aircraft to be established on the centre lines of parallel tracks or ATS routes spaced at a distance which ensures that the protected airspace of the tracks or ATS routes does not overlap.

- (f) Transitioning into airspace where a greater lateral separation minimum applies

Lateral separation will exist when aircraft are established on specified tracks which:

- (1) are separated by an appropriate minimum; and
- (2) diverge by at least 15 degrees until the applicable lateral separation minimum is established,

provided that it is possible to ensure, by means approved by the competent authority, that aircraft have the navigation capability necessary to ensure accurate track guidance.

GM1 to AMC1 ATS.TR.210(c)(2)(ii) Operation of air traffic control service

ED Decision 2020/008/R

PROCEDURAL CONTROL — LATERAL SEPARATION OF AIRCRAFT ON PUBLISHED INSTRUMENT FLIGHT PROCEDURES FOR ARRIVALS AND DEPARTURES

ICAO Circular 324 ‘Guidelines for Lateral Separation of Arriving and Departing Aircraft on Published Adjacent Instrument Flight Procedures’ contains information on separation of arrival and departure tracks using non-overlapping protected areas based on obstacle clearance criteria, as provided for in ICAO Doc 8168 ‘Procedures for Air Navigation Services — Aircraft Operations, Volume II — Construction of Visual and Instrument Flight Procedures’.

GM1 ATS.TR.210(c)(2)(ii) Operation of air traffic control service

ED Decision 2020/008/R

PROCEDURAL CONTROL — LATERAL SEPARATION APPLICATION

- (a) Lateral separation should be applied so that the distance between those portions of the intended routes for which the aircraft are to be laterally separated is never less than an established distance to account for navigational inaccuracies plus a specified buffer. This buffer should be determined by the air traffic services provider and approved by the competent authority and included in the lateral separation minima as an integral part thereof.
- (b) Lateral separation of aircraft is obtained by requiring operation on different routes or in different geographical locations as determined by visual observation, by the use of navigation aids or by the use of RNAV equipment.
- (c) Where a route flown by an aircraft involves a specified turn which will result in the minimum lateral separation being infringed, another type of separation or another minimum shall be established prior to the aircraft commencing the turn (see Figures 41 and 42).
- (d) For flyover waypoints, aircraft are required to first fly over the waypoint before executing the turn. After the turn, the aircraft may either navigate to join the route immediately after the turn

or navigate to the next defined waypoint before rejoining the route. This will require additional lateral separation on the overflow side of the turn (See Figure 41).

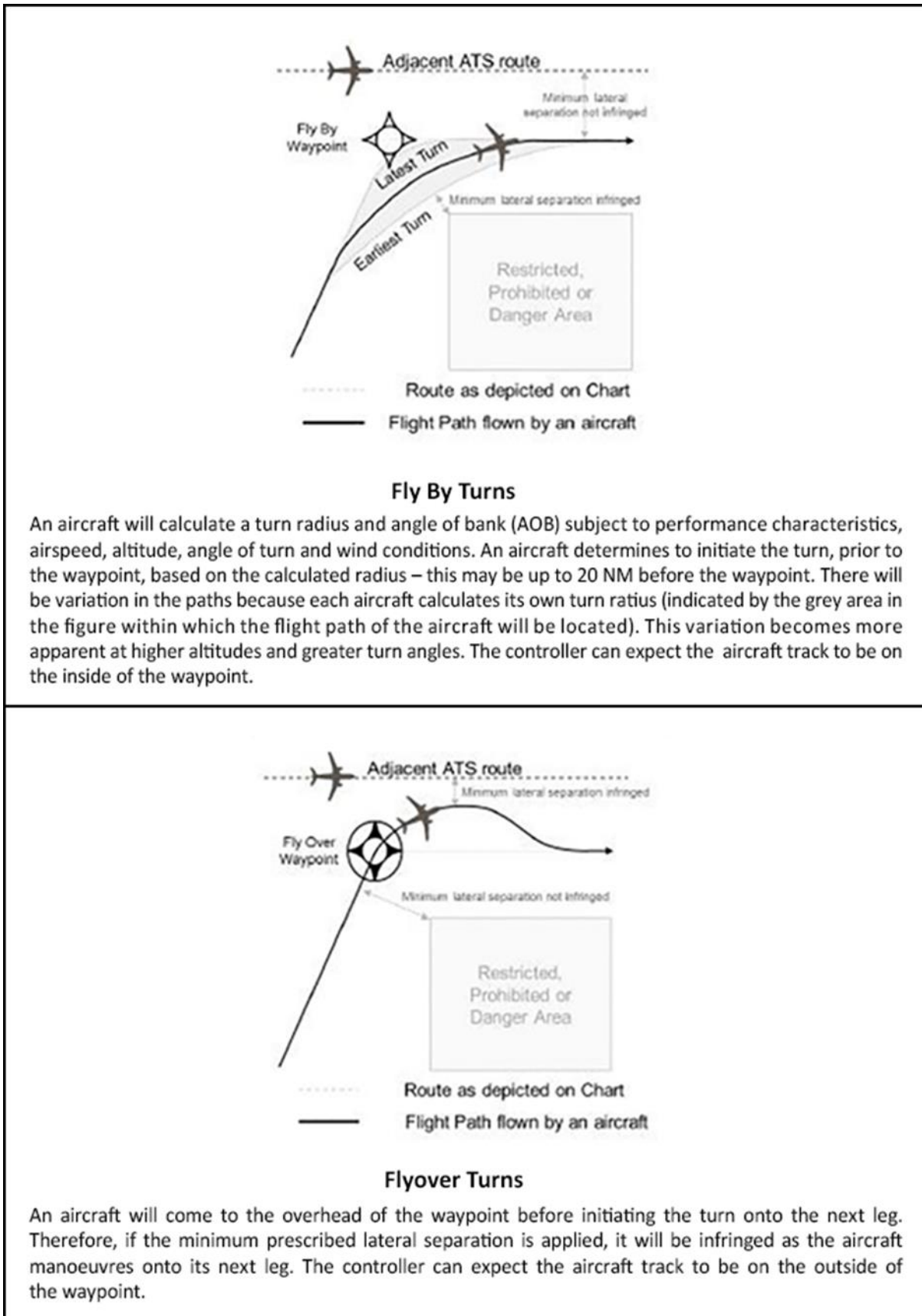

Figure 41: Turn over flyover waypoint and turn at fly-by waypoint

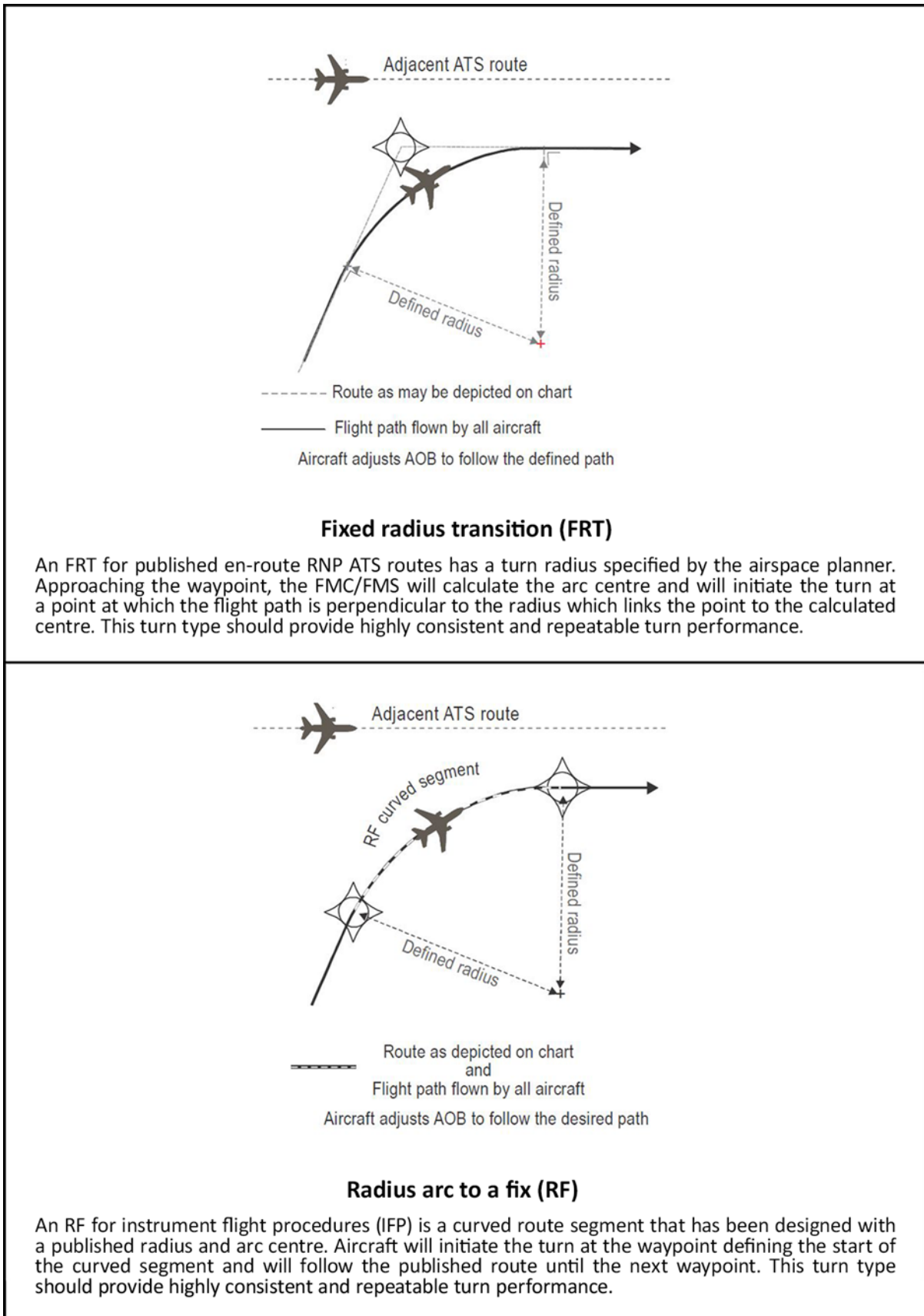

Figure 42: Fixed radius transition (FRT) and radius arc to a Fix (RF) turn

GM1 ATS.TR.210(d) Operation of air traffic control service

ED Decision 2020/008/R

APPLICATION OF SEPARATION MINIMA TO IDENTIFIED AIRCRAFT

- (a) When the control of an identified aircraft is to be transferred to a control sector that will provide the aircraft with procedural separation, the transferring air traffic controller should ensure that appropriate procedural separation is established between that aircraft and any other controlled aircraft before the transfer is effected.
- (b) When the control of an identified aircraft is to be transferred to a control sector that will provide the aircraft with procedural separation, such separation should be established by the transferring air traffic controller before the aircraft reaches the limits of the transferring air traffic controller's area of responsibility, or before the aircraft leaves the relevant area of surveillance coverage.

ATS.TR.215 Selection and notification of separation minima for the application of point ATS.TR.210(c)

Commission Implementing Regulation (EU) 2020/469

- (a) The selection of separation minima for application within a given portion of airspace shall be made by the air traffic services provider responsible for the provision of air traffic services and approved by the competent authority concerned.
- (b) For traffic that will pass from one into the other of neighbouring airspaces and for routes that are closer to the common boundary of the neighbouring airspaces than the separation minima applicable in the circumstances, the selection of separation minima shall be made in consultation with the air traffic services providers responsible for the provision of air traffic services in neighbouring airspace.
- (c) Details of the selected separation minima and of their areas of application shall be notified:
 - (1) to the air traffic services units concerned;
 - (2) to pilots and aircraft operators through aeronautical information publications, where separation is based on the use by aircraft of specified navigation aids or specified navigation techniques.

ATS.TR.220 Application of wake turbulence separation

Commission Implementing Regulation (EU) 2020/469

- (a) Air traffic control units shall apply wake turbulence separation minima to aircraft in the approach and departure phases of flight in either of the following circumstances:
 - (1) an aircraft is operating directly behind another aircraft at the same altitude or less than 300 m (1 000 ft) below it;
 - (2) both aircraft are using the same runway, or parallel runways separated by less than 760 m (2 500 ft);
 - (3) an aircraft is crossing behind another aircraft, at the same altitude or less than 300 m (1 000 ft) below it.

- (b) Paragraph (a) shall not apply to arriving VFR flights and to arriving IFR flights executing visual approach when the aircraft has reported the preceding aircraft in sight and has been instructed to follow and maintain own separation from that aircraft. In those cases, the air traffic control unit shall issue caution for wake turbulence.

AMC1 ATS.TR.220 Application of wake turbulence separation

ED Decision 2020/008/R

CATEGORISATION OF AIRCRAFT FOR THE PURPOSES OF WAKE TURBULENCE SEPARATION MINIMA APPLICATION

Wake turbulence separation minima should be based on a grouping of aircraft types into four categories according to the maximum certificated take-off mass as follows:

- (a) SUPER (S) if so identified by the competent authority;
- (b) HEAVY (H) — all aircraft types of 136 000 kg or more;
- (c) MEDIUM (M) — aircraft types less than 136 000 kg but more than 7 000 kg; and
- (d) LIGHT (L) — aircraft types of 7 000 kg or less.

GM1 to AMC1 ATS.TR.220 Application of wake turbulence separation

ED Decision 2020/008/R

For the Airbus A380-800 aircraft, with a maximum take-off mass in the order of 560 000 kg, it is recommended to apply an increase of the wake turbulence separation minima associated with the HEAVY category.

AMC2 ATS.TR.220 Application of wake turbulence separation

ED Decision 2020/008/R

TIME-BASED WAKE TURBULENCE LONGITUDINAL SEPARATION MINIMA — ARRIVING AIRCRAFT

Except for arriving VFR flights, and for arriving IFR flights executing visual approach, the following separation minima should be applied to aircraft landing behind a SUPER, a HEAVY or a MEDIUM aircraft:

- (a) MEDIUM aircraft behind SUPER aircraft: 3 minutes;
- (b) MEDIUM aircraft behind HEAVY aircraft: 2 minutes;
- (c) LIGHT aircraft behind SUPER aircraft: 4 minutes; and
- (d) LIGHT aircraft behind a HEAVY or MEDIUM aircraft: 3 minutes.

AMC3 ATS.TR.220 Application of wake turbulence separation

ED Decision 2020/008/R

TIME-BASED WAKE TURBULENCE LONGITUDINAL SEPARATION MINIMA — DEPARTING AIRCRAFT

- (a) A separation minimum of 3 minutes should be applied for a LIGHT or MEDIUM aircraft and 2 minutes for a HEAVY aircraft taking off behind a SUPER aircraft when the aircraft are using:

- (1) the same runway;
 - (2) parallel runways separated by less than 760 m (2 500 ft);
 - (3) crossing runways if the projected flight path of the second aircraft will cross the projected flight path of the first aircraft at the same altitude or less than 300 m (1 000 ft) below; and
 - (4) parallel runways separated by 760 m (2 500 ft) or more if the projected flight path of the second aircraft will cross the projected flight path of the first aircraft at the same altitude or less than 300 m (1 000 ft) below.
- (b) A separation minimum of 4 minutes should be applied for a LIGHT or MEDIUM aircraft when taking off behind an SUPER aircraft from:
- (1) an intermediate part of the same runway; or
 - (2) an intermediate part of a parallel runway separated by less than 760 m (2 500 ft).
- (c) A separation minimum of 2 minutes should be applied between a LIGHT or MEDIUM aircraft taking off behind a HEAVY aircraft or a LIGHT aircraft taking off behind a MEDIUM aircraft when the aircraft are using:
- (1) the same runway (see Figure 43);
 - (2) parallel runways separated by less than 760 m (2 500 ft) (see Figure 43);
 - (3) crossing runways if the projected flight path of the second aircraft will cross the projected flight path of the first aircraft at the same altitude or less than 300 m (1 000 ft) below (see Figure 44); and
 - (4) parallel runways separated by 760 m (2 500 ft) or more if the projected flight path of the second aircraft will cross the projected flight path of the first aircraft at the same altitude or less than 300 m (1 000 ft) below (see Figure 44).

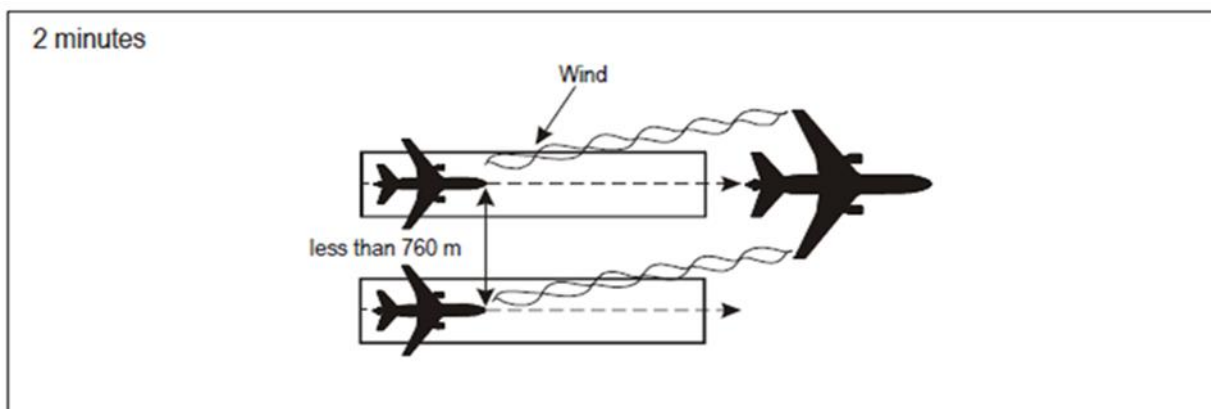

Figure 43: 2-minute separation for following aircraft

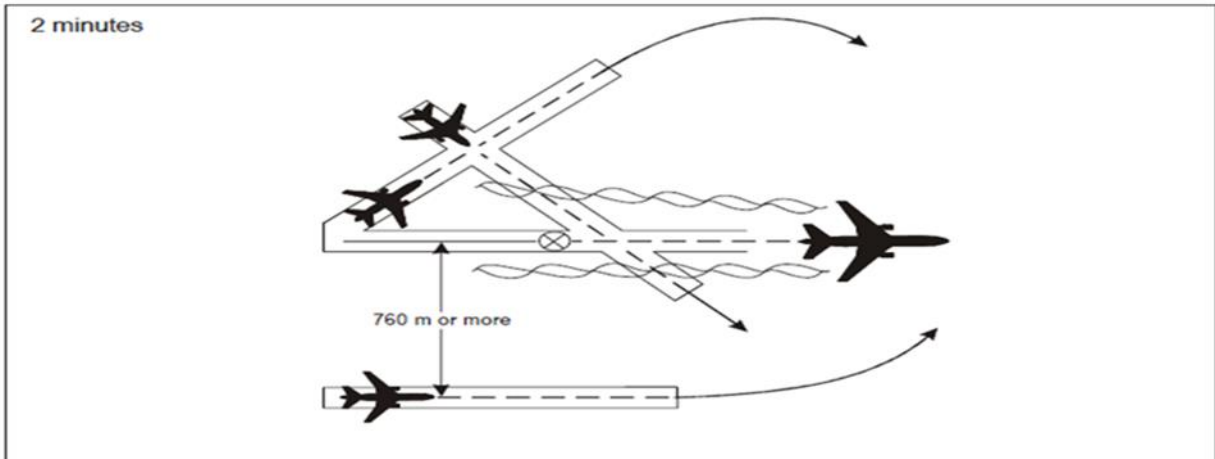

Figure 44: 2-minute wake turbulence separation for crossing aircraft

- (d) A separation minimum of 3 minutes should be applied (see Figure 45) between a LIGHT or MEDIUM aircraft when taking off behind a HEAVY aircraft or a LIGHT aircraft when taking off behind a MEDIUM aircraft from:
- (1) an intermediate part of the same runway; or
 - (2) an intermediate part of a parallel runway separated by less than 760 m (2 500 ft).

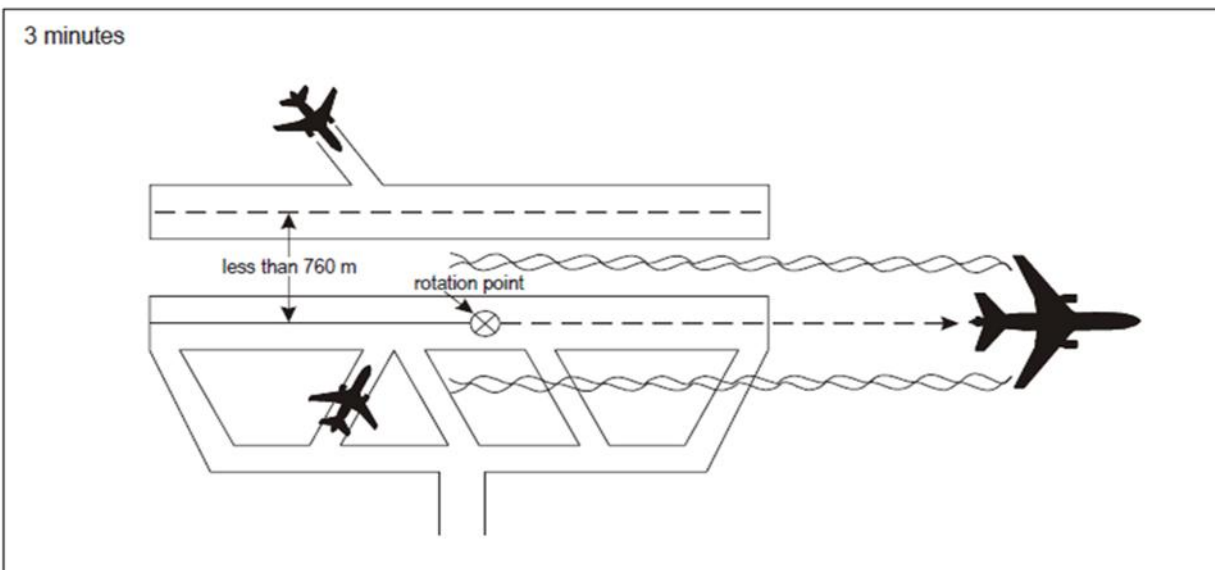

Figure 45: 3-minute wake turbulence separation for following aircraft

AMC4 ATS.TR.220 Application of wake turbulence separation

ED Decision 2020/008/R

TIME-BASED WAKE TURBULENCE LONGITUDINAL SEPARATION MINIMA — DISPLACED LANDING THRESHOLD

- (a) A separation minimum of 3 minutes should be applied between a LIGHT or MEDIUM aircraft and a SUPER aircraft when operating on a runway with a displaced landing threshold when:
- (1) a departing LIGHT or MEDIUM aircraft follows a SUPER aircraft arrival; or

- (2) an arriving LIGHT or MEDIUM aircraft follows a SUPER aircraft departure, if the projected flight paths are expected to cross.
- (b) A separation minimum of 2 minutes should be applied between a LIGHT or MEDIUM aircraft and a HEAVY aircraft and between a LIGHT aircraft and a MEDIUM aircraft when operating on a runway with a displaced landing threshold when:
 - (1) a departing LIGHT or MEDIUM aircraft follows a HEAVY aircraft arrival and a departing LIGHT aircraft follows a MEDIUM aircraft arrival; or
 - (2) an arriving LIGHT or MEDIUM aircraft follows a HEAVY aircraft departure and an arriving LIGHT aircraft follows a MEDIUM aircraft departure, if the projected flight paths are expected to cross.

AMC5 ATS.TR.220 Application of wake turbulence separation

ED Decision 2020/008/R

TIME-BASED WAKE TURBULENCE LONGITUDINAL SEPARATION MINIMA — OPPOSITE DIRECTION

- (a) A separation minimum of 3 minutes should be applied between a LIGHT or MEDIUM aircraft and a SUPER aircraft when the SUPER aircraft is making a low or missed approach and the LIGHT or MEDIUM aircraft is:
 - (1) utilising an opposite-direction runway for take-off; or
 - (2) landing on the same runway in the opposite direction, or on a parallel opposite-direction runway separated by less than 760 m (2 500 ft).
- (b) A separation minimum of 2 minutes should be applied between a LIGHT or MEDIUM aircraft and a HEAVY aircraft and between a LIGHT aircraft and a MEDIUM aircraft when the heavier aircraft is making a low or missed approach and the lighter aircraft is:
 - (1) utilising an opposite-direction runway for take-off (see Figure 46); or

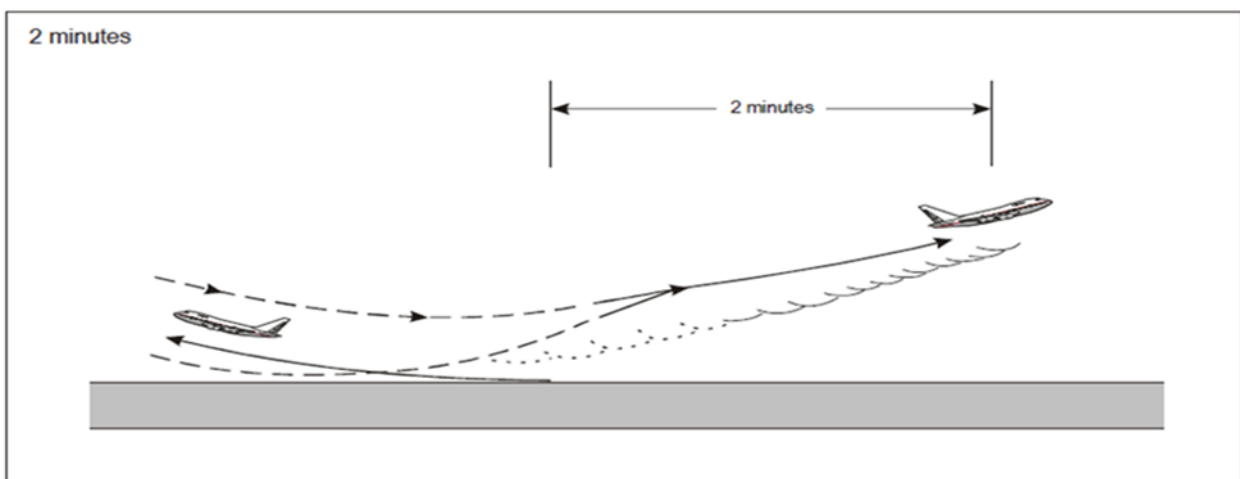

Figure 46: 2-minute wake turbulence separation for opposite-direction take-off

- (2) landing on the same runway in the opposite direction, or on a parallel opposite-direction runway separated by less than 760 m (2 500 ft) (see Figure 47).

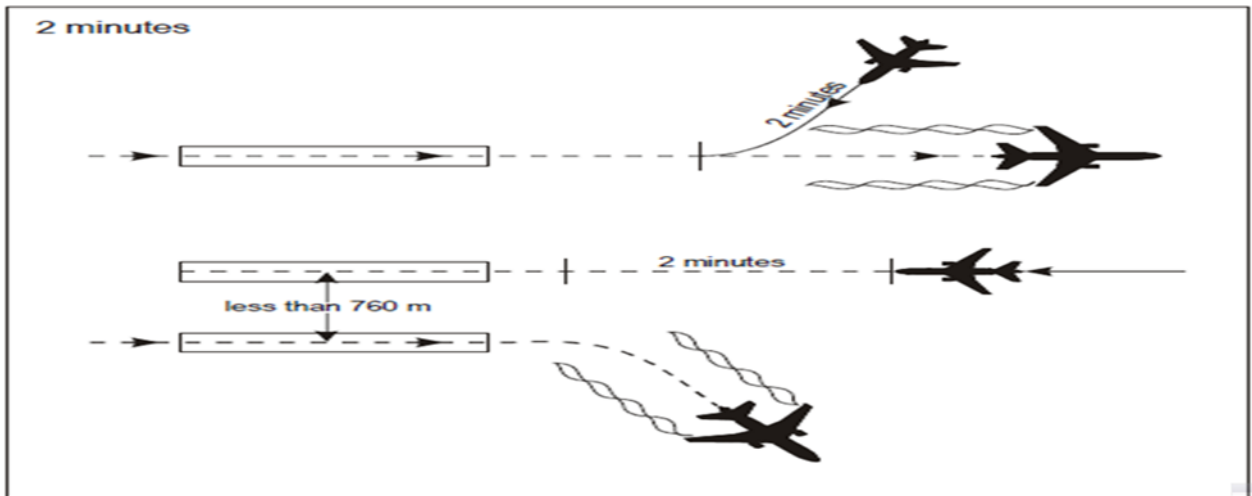

Figure 47: 2-minute wake turbulence separation for opposite-direction landing

AMC6 ATS.TR.220 Application of wake turbulence separation

ED Decision 2020/008/R

DISTANCE-BASED WAKE TURBULENCE SEPARATION MINIMA BASED ON ATS SURVEILLANCE SYSTEM

The following distance-based wake turbulence separation minima should be applied to aircraft being provided with an ATS surveillance service in the approach and departure phases:

PRECEDING AIRCRAFT	SUCCEEDING AIRCRAFT	WAKE TURBULENCE RADAR SEPARATION MINIMA
SUPER or HEAVY	SUPER	Not required. In this case, separation reverts to radar separation minima as established by the air traffic services provider and approved by the competent authority.
SUPER	HEAVY	11.1 km (6.0 NM)
SUPER	MEDIUM	13.0 km (7.0 NM)
SUPER	LIGHT	14.8 km (8.0 NM)
HEAVY	HEAVY	7.4 km (4.0 NM)
HEAVY	MEDIUM	9.3 km (5.0 NM)
HEAVY	LIGHT	11.1 km (6.0 NM)
MEDIUM	LIGHT	9.3 km (5 NM)

GM1 to AMC6 ATS.TR.220 Application of wake turbulence separation

ED Decision 2020/008/R

Figures 48 and 49 illustrate the application of the separation minima between HEAVY, MEDIUM and LIGHT aircraft prescribed in [AMC6 ATS.TR.220](#).

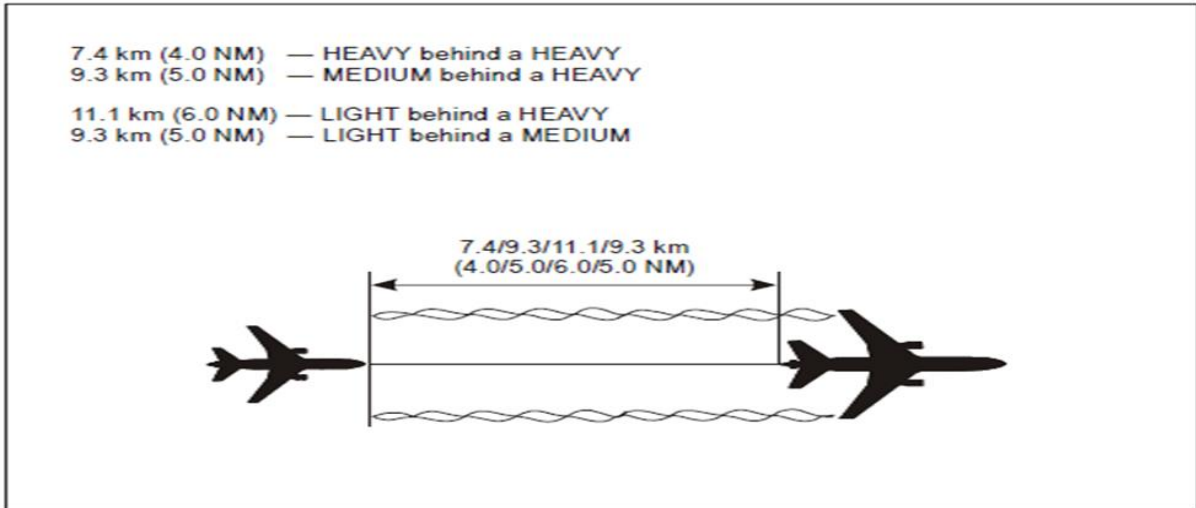

Figure 48: Operating directly behind

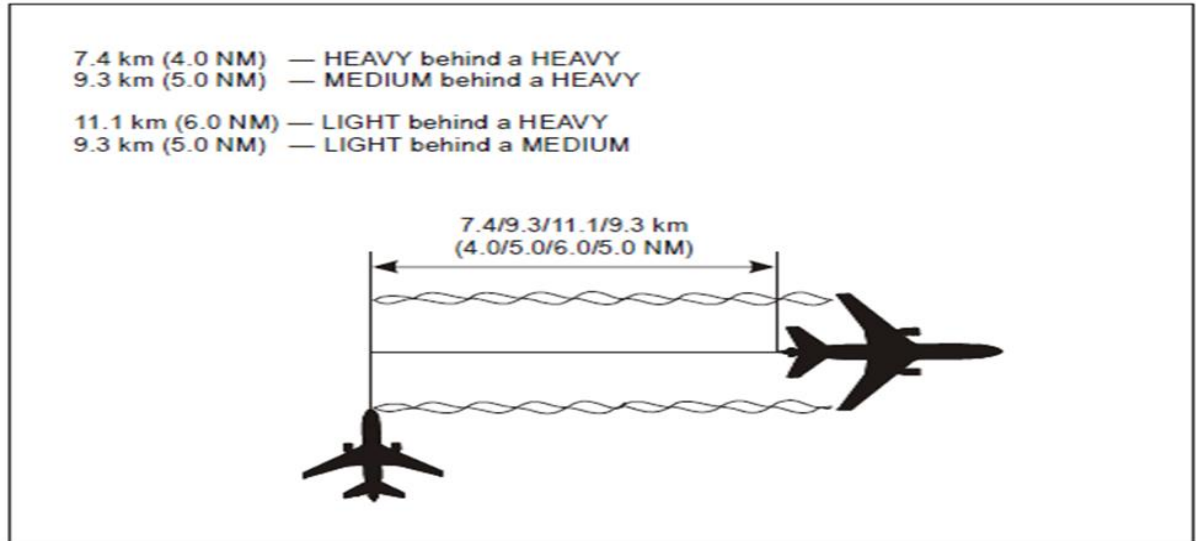

Figure 49: Crossing behind

AMC7 ATS.TR.220 Application of wake turbulence separation

ED Decision 2020/008/R

RECAT-EU WAKE TURBULENCE SEPARATION MINIMA

- (a) As an alternative to the wake turbulence separation minima prescribed in [AMC1 to AMC6 ATS.TR.220](#), an air traffic services provider may decide to implement RECAT-EU or parts thereof, subject to the approval of the competent authority.
- (b) The following wake vortex aircraft groupings, based on the allocation of aircraft types to six categories according to both maximum certificated take-off mass and wingspan, and associated separation minima should be used when applying RECAT-EU:
- (1) 'SUPER HEAVY' — all aircraft types of 100 000 kg or more, and a wingspan between 72 m and 80 m;
 - (2) 'UPPER HEAVY' — all aircraft types of 100 000 kg or more, and a wingspan between 60 m and 72 m;
 - (3) 'LOWER HEAVY' — all aircraft types of 100 000 kg or more, and a wingspan below 52 m;
 - (4) 'UPPER MEDIUM' — aircraft types less than 100 000 kg but more than 15 000 kg, and a wingspan above 32 m;
 - (5) 'LOWER MEDIUM' — aircraft types less than 100 000 kg but more than 15 000 kg, and a wingspan below 32 m;
 - (6) 'LIGHT' — all aircraft types of 15 000 kg or less (without wingspan criterion).
- (c) Aircraft types with maximum certificated take-off mass of 100 000 kg or more, and wingspan between 52 m and 60 m are included in one of the above categories on the basis of specific analyses.
- (d) RECAT-EU wake turbulence distance-based separation minima for arriving and departing aircraft when ATS surveillance service is provided should be:

RECAT-EU Scheme	Follower					
	Super Heavy	Upper Heavy	Lower Heavy	Upper Medium	Lower Medium	Light
Super Heavy	3 NM	4 NM	5 NM	5 NM	6 NM	8 NM
Upper Heavy	(*)	3 NM	4 NM	4 NM	5 NM	7 NM
Lower Heavy	(*)	(*)	3 NM	3 NM	4 NM	6 NM
Upper Medium	(*)	(*)	(*)	(*)	(*)	5 NM
Lower Medium	(*)	(*)	(*)	(*)	(*)	4 NM
Light	(*)	(*)	(*)	(*)	(*)	3 NM

(*) means that the separation minimum to be applied is the horizontal separation minimum based on an ATS surveillance system (established in accordance with [AMC1 ATS.TR.210\(c\)\(2\)](#)), and should remain compatible with runway capacity.

- (e) RECAT-EU wake turbulence time-based separation minima between departing aircraft should be:

RECAT-EU scheme		Super Heavy	Upper Heavy	Lower Heavy	Upper Medium	Lower Medium	Light
Leader / Follower		A	B	C	D	E	F
"Super Heavy"	A		100s	120s	140s	160s	180s
"Upper Heavy"	B				100s	120s	140s
"Lower Heavy"	C				80s	100s	120s
"Upper Medium"	D						120s
"Lower Medium"	E						100s
"Light"	F						80s

- (f) Wake turbulence time-based separation minima between departing aircraft should be applied by determining airborne times between successive aircraft.
- (g) An additional 60 seconds should be applied to all the wake turbulence time-based separation minima above when taking off from:
- (1) an intermediate part of the same runway; or

- (2) an intermediate part of a parallel runway separated by less than 760 m (2 500 ft).

GM1 to AMC7 ATS.TR.220 Application of wake turbulence separation

ED Decision 2020/008/R

APPLICATION OF RECAT-EU WAKE TURBULENCE SEPARATION SCHEME

- (a) The implementation of RECAT-EU or parts thereof is considered to be a change to the air traffic services provider functional system and, as such, is supported by a safety assessment, in accordance with ATS.OR.205. Any such implementation should provide clear operational benefits.
- (b) While the ICAO flight plan remains unchanged, the RECAT-EU wake vortex aircraft grouping should be displayed to air traffic controllers using the associated aircraft type information available in the flight data processing system.
- (c) A list of aircraft types for each RECAT-EU aircraft grouping, in particular with respect to new aircraft types, is maintained by EASA and is available at <https://www.easa.europa.eu/easa-and-you/air-traffic-management#group-easa-downloads>.

GM1 ATS.TR.220 Application of wake turbulence separation

ED Decision 2020/008/R

WAKE TURBULENCE EFFECTS INDUCED BY HELICOPTERS

- (a) Helicopters should be kept well clear of light aircraft when hovering or while air-taxiing.
- (b) Helicopters produce vortices when in flight and there is some evidence that, per kilogramme of gross mass, their vortices are more intense than those of fixed-wing aircraft. When hovering in ground effect or air taxiing, helicopters generate downwash producing high-velocity outwash vortices to a distance approximately three times the diameter of the rotor.

ATS.TR.225 Responsibility for control

Commission Implementing Regulation (EU) 2020/469

- (a) A controlled flight shall be under the control of only one air traffic control unit at any given time.
- (b) Responsibility for the control of all aircraft operating within a given block of airspace shall be vested in a single air traffic control unit. However, control of an aircraft or groups of aircraft may be delegated to other air traffic control units provided that coordination between all air traffic control units concerned is assured.

ATS.TR.230 Transfer of responsibility for control

Commission Implementing Regulation (EU) 2020/469

- (a) Place or time of transfer

The responsibility for the control of an aircraft shall be transferred from one air traffic control unit to another as follows:

- (1) Between two units providing area control service

The responsibility for the control of an aircraft shall be transferred from a unit providing area control service in a control area to the unit providing area control service in an adjacent control area at the time of crossing the common control area boundary as estimated by the area control centre having control of the aircraft or at such other point or time as has been agreed between the two units.

- (2) Between a unit providing area control service and a unit providing approach control service or between two units providing approach control service

The responsibility for the control of an aircraft shall be transferred from one unit to another, and vice versa, at a point or time agreed between the two units.

- (3) Between a unit providing approach control service and an aerodrome control tower
- (i) Arriving aircraft – The responsibility for the control of an arriving aircraft shall be transferred, as specified in letters of agreement and operation manuals, as appropriate, from the unit providing approach control service to the aerodrome control tower when the aircraft is in either of the following states:
- (A) is in the vicinity of the aerodrome, and:
- (a) it is considered that approach and landing will be completed in visual reference to the ground, or
- (b) it has reached uninterrupted VMC;
- (B) is at a prescribed point or level;
- (C) has landed.
- (ii) Departing aircraft – The responsibility for control of a departing aircraft shall be transferred, as specified in letters of agreement and operation manuals, as appropriate, from the aerodrome control tower to the unit providing approach control service:
- (A) when VMC prevail in the vicinity of the aerodrome:
- (a) prior to the time the aircraft leaves the vicinity of the aerodrome, or
- (b) prior to the aircraft entering instrument meteorological conditions (IMC), or
- (c) at a prescribed point or level;
- (B) when IMC prevail at the aerodrome:
- (a) immediately after the aircraft is airborne, or
- (b) at a prescribed point or level.
- (4) Between control sectors or positions within the same air traffic control unit

The responsibility for control of an aircraft shall be transferred from one control sector or position to another control sector or position within the same air traffic control unit at a point, level or time, as specified in air traffic services unit instructions.

- (b) Coordination of transfer

- (1) Responsibility for control of an aircraft shall not be transferred from one air traffic control unit to another without the consent of the accepting control unit, which shall be obtained in accordance with points (2), (3), (4) and (5).

- (2) The transferring control unit shall communicate to the accepting control unit the appropriate parts of the current flight plan and any control information pertinent to the transfer requested.
- (3) Where transfer of control is to be effected using ATS surveillance systems, the control information pertinent to the transfer shall include information regarding the position and, if required, the track and speed of the aircraft, as observed by ATS surveillance systems immediately prior to the transfer.
- (4) Where transfer of control is to be effected using ADS-C data, the control information pertinent to the transfer shall include the four-dimensional position and other information as necessary.
- (5) The accepting control unit shall:
 - (i) indicate its ability to accept control of the aircraft on the terms specified by the transferring control unit, unless by prior agreement between the two units concerned the absence of any such indication is understood to signify acceptance of the terms specified, or indicate any necessary changes thereto;
 - (ii) specify any other information or clearance for a subsequent portion of the flight, which it requires the aircraft to have at the time of transfer.
- (6) Unless otherwise specified by an agreement between the two control units concerned, the accepting control unit shall not notify the transferring control unit when it has established two-way voice or data link communications, or both, with and assumed control of the aircraft concerned.
- (7) Standardised phraseology shall be used in the coordination between air traffic services units or sectors, or both. Only when standardised phraseology cannot serve an intended transmission, plain language shall be used.

AMC1 ATS.TR.230 Transfer of responsibility for control

ED Decision 2020/008/R

COORDINATION IN RESPECT OF THE AIR TRAFFIC CONTROL SERVICE PROVISION — GENERAL

Agreements between air traffic control units or sectors and local instructions concerning coordination and transfer of control of flights should cover the following, as applicable:

- (a) definition of areas of responsibility and common interest, airspace structure and airspace classification(s);
- (b) any delegation of responsibility for the provision of air traffic services;
- (c) procedures for the exchange of flight plan and control data, including use of automated and/or verbal coordination messages;
- (d) means of communication;
- (e) requirements and procedures for approval requests;
- (f) significant points, levels or times for transfer of control;
- (g) significant points, levels or times for transfer of communication;

- (h) conditions applicable to the transfer and acceptance of control, such as specified altitudes/flight levels, specific separation minima or spacing to be established at the time of transfer, and the use of automation;
- (i) ATS surveillance system coordination procedures;
- (j) SSR code assignment procedures;
- (k) procedures for departing traffic;
- (l) designated holding fixes and procedures for arriving traffic;
- (m) applicable contingency procedures; and
- (n) any other provisions or information relevant to the coordination and transfer of control of flights.

GM1 ATS.TR.230 Transfer of responsibility for control

ED Decision 2020/008/R

COORDINATION IN RESPECT OF THE AIR TRAFFIC CONTROL SERVICE PROVISION — GENERAL

- (a) The coordination and transfer of control of a flight between successive air traffic control units and control sectors should be effected by a dialogue comprising the following stages:
 - (1) notification of the flight in order to prepare for coordination, as necessary;
 - (2) coordination of conditions of transfer of control by the transferring air traffic control unit;
 - (3) coordination, if necessary, and acceptance of conditions of transfer of control by the accepting control unit; and
 - (4) transfer of control to the accepting control unit or control sector.
- (b) Air traffic control units should, to the extent possible, establish and apply standardised procedures for the coordination and transfer of control of flights, in order, inter alia, to reduce the need for verbal coordination. Such coordination procedures should be specified in letters of agreement and local instructions, as applicable.

GM2 ATS.TR.230 Transfer of responsibility for control

ED Decision 2020/008/R

LETTERS OF AGREEMENT AND OPERATION MANUALS

Relevant information contained in letters of agreement should be included in the operation manual of the air traffic services units concerned.

AMC1 ATS.TR.230(a) Transfer of responsibility for control

ED Decision 2020/008/R

COORDINATION BETWEEN AIR TRAFFIC CONTROL UNITS PROVIDING AIR TRAFFIC SERVICE WITHIN CONTIGUOUS CONTROL AREAS — TRANSFER OF CONTROL

- (a) The responsibility for the control of an aircraft should be transferred from the air traffic control unit to the next unit at the time of crossing the common control area boundary as determined by the unit having control of the aircraft or at such other point or time as has been agreed between the two units.

- (b) Where specified in letters of agreement between the air traffic control units concerned, and when transferring an aircraft, the transferring unit should notify the accepting control unit that the aircraft is in position to be transferred, and specify that the responsibility for control should be assumed by the accepting control unit forthwith at the time of crossing the control boundary or other transfer control point specified in letters of agreement between the air traffic control units or at such other point or time coordinated between the two units.
- (c) If the transfer of control time or point is other than forthwith, the accepting control unit should not alter the clearance of the aircraft prior to the agreed transfer of control time or point without the approval of the transferring unit.
- (d) If transfer of communication is used to transfer an aircraft to an accepting control unit, responsibility for control should not be assumed until the time of crossing the control area boundary or other transfer of control point specified in letters of agreement between the air traffic control units.

GM1 ATS.TR.230(a)(2) Transfer of responsibility for control

ED Decision 2020/008/R

DIVISION OF CONTROL BETWEEN A UNIT PROVIDING AREA CONTROL SERVICE AND A UNIT PROVIDING APPROACH CONTROL SERVICE

- (a) Except when otherwise specified in letters of agreement or local instructions, or by the ACC concerned in individual cases, a unit providing approach control service may issue clearances to any aircraft released to it by an ACC without reference to the ACC. However, when an approach has been missed, the ACC should, if affected by the missed approach, be advised immediately and subsequent action should be coordinated between the ACC and the unit providing approach control service as necessary.
- (b) An ACC may, after coordination with the unit providing approach control service, release aircraft directly to aerodrome control towers if the entire approach will be made under VMC.

GM1 ATS.TR.230(a)(3) Transfer of responsibility for control

ED Decision 2020/008/R

DIVISION OF CONTROL BETWEEN A UNIT PROVIDING APPROACH CONTROL SERVICE AND A UNIT PROVIDING AERODROME CONTROL SERVICE

- (a) A unit providing approach control service should retain control of arriving aircraft until such aircraft have been transferred to the aerodrome control tower and are in communication with the aerodrome control tower. Letters of agreement or local instructions, appropriate to the airspace structure, terrain, meteorological conditions and air traffic services facilities available, should establish rules for the transfer of arriving aircraft.
- (b) A unit providing approach control service may authorise an aerodrome control tower to release an aircraft for take-off subject to the discretion of the aerodrome control tower with respect to arriving aircraft.
- (c) Aerodrome control towers should, when so prescribed in letters of agreement or local instructions, obtain approval from the unit providing approach control service prior to authorising operation of special VFR flights.

GM2 ATS.TR.230(a)(3) Transfer of responsibility for control

ED Decision 2020/008/R

TRANSFER OF FLIGHTS BETWEEN ACC AND AERODROME CONTROL TOWER

Even though there is an approach control unit, control of certain flights may be transferred directly from an ACC to an aerodrome control tower and vice versa, subject to prior arrangement between the units concerned for the relevant part of approach control service to be provided by the ACC or the aerodrome control tower, as applicable.

GM1 ATS.TR.230(a)(3)(i) Transfer of responsibility for control

ED Decision 2020/008/R

COORDINATION OF STANDARD CLEARANCES FOR ARRIVING AIRCRAFT

- (a) Wherever possible, the air traffic services providers concerned should establish standardised procedures for transfer of control between the air traffic control units concerned and standard clearances for arriving aircraft.
- (b) Where standard clearances for arriving aircraft are in use and, provided no terminal delay is expected, clearance to follow the appropriate standard instrumental arrival (STAR) will normally be issued by the ACC without prior coordination with or approval from the approach control unit or the aerodrome control tower, as applicable.
- (c) Prior coordination of clearances should be required only in the event that a variation to the standard clearance or the standardised transfer of control procedures is necessary or desirable for operational reasons.
- (d) Provision should be made to:
 - (1) ensure that the approach control unit is at all times kept informed of the sequence of aircraft following the same STAR; and
 - (2) display the designators of assigned STARs to the ACC, the approach control unit and/or the aerodrome control tower, as applicable.

GM1 ATS.TR.230(a)(3)(ii) Transfer of responsibility for control

ED Decision 2020/008/R

COORDINATION OF STANDARD CLEARANCES FOR DEPARTING AIRCRAFT

- (a) Wherever possible, the air traffic services providers concerned should establish standardised procedures for transfer of control between the air traffic control units concerned and standard clearances for departing aircraft.
- (b) Where standard clearances for departing aircraft have been agreed to between the units concerned, the aerodrome control tower will normally issue the appropriate standard clearance without prior coordination with or approval from the approach control unit or ACC.
- (c) Prior coordination of clearances should be required only in the event that a variation to the standard clearance or the standardised transfer of control procedures is necessary or desirable for operational reasons; for example, in the case of a change on the cleared initial flight level.
- (d) Provision should be made to:
 - (1) ensure that the approach control unit at all times is kept informed of the sequence in which aircraft will depart as well as the runway to be used; and

- (2) display the designators of assigned standard instrumental departures (SIDs) to the aerodrome control tower, the approach control unit and/or the ACC as applicable.

AMC1 ATS.TR.230(a)(4) Transfer of responsibility for control

ED Decision 2020/008/R

COORDINATION BETWEEN CONTROL POSITIONS WITHIN THE SAME UNIT

Appropriate flight plan and control information should be exchanged between control positions within the same air traffic control unit, in respect of:

- (a) all aircraft for which responsibility for control will be transferred from one control position to another;
- (b) aircraft operating in such close proximity to the boundary between control sectors that control of traffic within an adjacent sector may be affected;
- (c) all aircraft for which responsibility for control has been delegated by an air traffic controller using procedural methods to an air traffic controller using an ATS surveillance system, as well as other aircraft affected.

AMC1 ATS.TR.230(b)(2) Transfer of responsibility for control

ED Decision 2020/008/R

COORDINATION BETWEEN AIR TRAFFIC CONTROL UNITS PROVIDING AIR TRAFFIC SERVICES WITHIN CONTIGUOUS CONTROL AREAS — GENERAL

- (a) Air traffic control units should forward from unit to unit, as the flight progresses, necessary flight plans and control information. When so required by agreement between air traffic services providers concerned, flight plans and flight progress information for flights along specified routes or portions of routes in close proximity to flight information region (FIR) boundaries should also be provided to the air traffic control units in charge of the FIRs adjacent to such routes or portions of routes.
- (b) The flight plan and control information in point (b) of ATS.TR.230 should be transmitted in sufficient time to permit reception and analysis of the data by the receiving unit(s) and necessary coordination between the units concerned.

AMC2 ATS.TR.230(b)(2) Transfer of responsibility for control

ED Decision 2020/008/R

EXCHANGE OF MOVEMENT AND CONTROL DATA BETWEEN A UNIT PROVIDING AREA CONTROL SERVICE AND A UNIT PROVIDING APPROACH CONTROL SERVICE

- (a) The unit providing approach control service should keep the ACC promptly advised of pertinent data on controlled traffic.
- (b) The ACC should keep the unit providing approach control service promptly advised of pertinent data on controlled traffic.
- (c) The ACC should normally forward to the unit providing approach control service information on arriving aircraft not less than 15 minutes before the estimated time of arrival and should revise such information as necessary

GM1 to AMC2 ATS.TR.230(b)(2) Transfer of responsibility for control

ED Decision 2020/008/R

EXCHANGE OF MOVEMENT AND CONTROL DATA FROM A UNIT PROVIDING APPROACH CONTROL SERVICE TO A UNIT PROVIDING AREA CONTROL SERVICE

Pertinent data on controlled traffic should include:

- (a) runway(s)-in-use and expected type of instrument approach procedure;
- (b) lowest vacant level at the holding fix available for use by the ACC;
- (c) average time interval or distance between successive arrivals as determined by the unit providing approach control service;
- (d) revision of the expected approach time issued by the ACC when the calculation of the expected approach time by the unit providing approach control service indicates a variation of 5 minutes or such other time as has been agreed between the two air traffic control units concerned;
- (e) arrival times over the holding fix when these vary by 3 minutes, or such other time as has been agreed between the two air traffic control units concerned, from those previously estimated;
- (f) cancellations by aircraft of IFR flight if these will affect levels at the holding fix or expected approach times of other aircraft;
- (g) aircraft departure times or, if agreed between the two air traffic control units concerned, the estimated time at the control area boundary or other specified point;
- (h) all available information relating to overdue or unreported aircraft; and
- (i) missed approaches which may affect the ACC.

GM2 to AMC2 ATS.TR.230(b)(2) Transfer of responsibility for control

ED Decision 2020/008/R

EXCHANGE OF MOVEMENT AND CONTROL DATA FROM A UNIT PROVIDING AREA CONTROL SERVICE TO A UNIT PROVIDING APPROACH CONTROL SERVICE

Pertinent data on controlled traffic should include:

- (a) identification, type and point of departure of arriving aircraft;
- (b) estimated time and proposed level of arriving aircraft over holding fix or other specified point;
- (c) actual time and proposed level of arriving aircraft over holding fix if the aircraft is released to the unit providing approach control service after arrival over the holding fix;
- (d) requested type of IFR approach procedure if different from that specified by the approach control unit;
- (e) expected approach time issued;
- (f) when required, statement that an aircraft has been instructed to contact the unit providing approach control service;
- (g) when required, statement that an aircraft has been released to the unit providing approach control service including, if necessary, the time and conditions of release; and

- (h) anticipated delay to departing traffic due to congestion.

AMC3 ATS.TR.230(b)(2) Transfer of responsibility for control

ED Decision 2020/008/R

EXCHANGE OF MOVEMENT AND CONTROL DATA BETWEEN A UNIT PROVIDING APPROACH CONTROL SERVICE AND A UNIT PROVIDING AERODROME CONTROL SERVICE

- (a) An aerodrome control tower should keep the unit providing approach control service promptly advised of pertinent data on relevant controlled traffic.
- (b) The unit providing approach control service should keep the aerodrome control tower promptly advised of pertinent data on controlled traffic.

GM1 to AMC3 ATS.TR.230(b)(2) Transfer of responsibility for control

ED Decision 2020/008/R

EXCHANGE OF MOVEMENT AND CONTROL DATA FROM AN AERODROME CONTROL TOWER TO A UNIT PROVIDING APPROACH CONTROL SERVICE

Pertinent data on controlled traffic should include:

- (a) arrival and departure times;
- (b) when required, statement that the first aircraft in an approach sequence is in communication with and is sighted by the aerodrome control tower, and that reasonable assurance exists that a landing can be accomplished;
- (c) all available information relating to overdue or unreported aircraft;
- (d) information concerning missed approaches; and
- (e) information concerning aircraft that constitute essential local traffic to aircraft under the control of the unit providing approach control service.

GM2 to AMC3 ATS.TR.230(b)(2) Transfer of responsibility for control

ED Decision 2020/008/R

EXCHANGE OF MOVEMENT AND CONTROL DATA FROM A UNIT PROVIDING APPROACH CONTROL SERVICE TO AN AERODROME CONTROL TOWER

Pertinent data on controlled traffic should include:

- (a) estimated time and proposed level of arriving aircraft over the aerodrome, at least 15 minutes prior to estimated arrival;
- (b) when required, a statement that an aircraft has been instructed to contact the aerodrome control tower and that control shall be assumed by that unit; and
- (c) anticipated delay to departing traffic due to congestion

GM1 ATS.TR.230(b)(2) Transfer of responsibility for control

ED Decision 2020/008/R

COORDINATION BETWEEN AIR TRAFFIC CONTROL UNITS FOR APPROVAL REQUESTS

- (a) If the flying time from the departure aerodrome of an aircraft to the boundary of an adjacent control area is less than the specified minimum required to permit transmission of the necessary flight plan and control information to the accepting control unit after take-off and to allow adequate time for reception, analysis and coordination, the transferring control unit should, prior to departure, forward that information to the accepting control unit together with a request for approval. The required time period should be specified in letters of agreement or local instructions, as appropriate. In the case of revisions to a previously transmitted current flight plan, and control data being transmitted earlier than this specified time period, no approval from the accepting control unit should be required.
- (b) In the case of an aircraft in flight requiring an initial clearance when the flying time to the boundary of an adjacent control area is less than a specified minimum, the aircraft should be held within the transferring air traffic control unit's control area until the flight plan and control information have been forwarded together with a request for approval, and coordination effected with the adjacent air traffic control unit.
- (c) In the case of an aircraft requesting a change in its current flight plan, or of a transferring air traffic control unit proposing to change the current flight plan of an aircraft, and the flying time of the aircraft to the control area boundary is less than a specified minimum, the revised clearance should be withheld pending approval of the proposal by the adjacent air traffic control unit.
- (d) When boundary estimate data is to be transmitted for approval by the accepting control unit, the time in respect of an aircraft not yet departed should be based on the estimated time of departure as determined by the air traffic control unit in whose area of responsibility the departure aerodrome is located. In respect of an aircraft in flight requiring an initial clearance, the time should be based on the estimated elapsed time from the holding fix to the boundary plus the time expected to be needed for coordination.

GM2 ATS.TR.230(b)(2) Transfer of responsibility for control

ED Decision 2020/008/R

COORDINATION BETWEEN AIR TRAFFIC CONTROL UNITS FOR TAKE-OFF AND CLEARANCE EXPIRY TIMES

- (a) The take-off time should be specified by the ACC when it is necessary to:
 - (1) coordinate the departure with traffic not released to the unit providing approach control service; and
 - (2) provide en-route separation between departing aircraft following the same track.
- (b) If the take-off time is not specified, the unit providing approach control service should determine it when necessary to coordinate the departure with traffic released to it.
- (c) A clearance expiry time should be specified by the ACC if a delayed departure would conflict with traffic not released to the unit providing approach control service. If, for traffic reasons of its own, a unit providing approach control service has to specify in addition its own clearance expiry time, this should not be later than that specified by the ACC.

GM3 ATS.TR.230(b)(2) Transfer of responsibility for control

ED Decision 2020/008/R

COORDINATION BETWEEN AIR TRAFFIC SERVICES UNITS FOR CHANGE FROM IFR TO VFR

An air traffic control unit receiving notification of an aircraft's intention to change from IFR to VFR flight should, as soon as practicable thereafter, so inform all other air traffic services units to whom the IFR flight plan was addressed, except those units through whose regions or areas the flight has already passed.

AMC1 ATS.TR.230(b)(7) Transfer of responsibility for control

ED Decision 2020/008/R

PHRASEOLOGIES TO BE USED IN THE COORDINATION BETWEEN AIR TRAFFIC SERVICES UNITS

- (a) When, in accordance with ATS.TR.120, communications between air traffic services units or sectors are effected in English language, the following phraseology should be used for the coordination:

<i>Circumstances</i>	<i>Phraseologies</i>
ESTIMATES AND REVISIONS <div style="margin-left: 100px;">... sending unit</div> <div style="margin-left: 100px;">... receiving unit reply (if flight plan details are not available)</div>	a) ESTIMATE [<i>direction of flight</i>] (<i>aircraft call sign</i>) [SQUAWKING (<i>SSR code</i>)] (<i>type</i>) ESTIMATED (<i>significant point</i>) (<i>time</i>) (<i>level</i>) (or DESCENDING FROM (<i>level</i>) TO (<i>level</i>)) [SPEED (<i>filed TAS</i>)] (<i>route</i>) [REMARKS]; b) ESTIMATE (<i>significant point</i>) ON (<i>aircraft call sign</i>); c) NO DETAILS;

<i>Circumstances</i>	<i>Phraseologies</i>
... receiving unit reply (if flight plan details are available) ... sending unit reply	<p>(aircraft type) (destination);</p> <p>[SQUAWKING (SSR code)] [ESTIMATED] (significant point) (time) AT (level);</p> <p><i>Note.</i> — In the event that flight plan details are not available the receiving station shall reply to b) NO DETAILS and transmitting station shall pass full estimate as in a).</p> <p>d) ESTIMATE UNMANNED FREE BALLOON(S) (identification and classification) ESTIMATED OVER (place) AT (time) REPORTED FLIGHT LEVEL(S) (figure or figures) [or FLIGHT LEVEL UNKNOWN] MOVING (direction) ESTIMATED GROUND SPEED (figure) (other pertinent information, if any);</p> <p>e) REVISION (aircraft call sign) (details as necessary).</p>
TRANSFER OF CONTROL	<p>a) REQUEST RELEASE OF (aircraft call sign);</p> <p>b) (aircraft call sign) RELEASED [AT (time)] [conditions/restrictions];</p> <p>c) IS (aircraft call sign) RELEASED [FOR CLIMB (or DESCENT)];</p> <p>d) (aircraft call sign) NOT RELEASED [UNTIL (time or significant point)];</p> <p>e) UNABLE (aircraft call sign) [TRAFFIC IS (details)].</p>
CHANGE OF CLEARANCE	<p>a) MAY WE CHANGE CLEARANCE OF (aircraft call sign) TO (details of alteration proposed);</p> <p>b) AGREED TO (alteration of clearance) OF (aircraft call sign);</p> <p>c) UNABLE (aircraft call sign);</p> <p>d) UNABLE (desired route, level, etc.) [FOR (aircraft call sign)] [DUE (reason)] (alternative clearance proposed).</p>
APPROVAL REQUEST	<p>a) APPROVAL REQUEST (aircraft call sign) ESTIMATED DEPARTURE FROM (significant point) AT (time);</p> <p>b) (aircraft call sign) REQUEST APPROVED [(restriction if any)];</p> <p>c) (aircraft call sign) UNABLE (alternative instructions).</p>

<i>Circumstances</i>	<i>Phraseologies</i>
INBOUND RELEASE	[INBOUND RELEASE] (<i>aircraft call sign</i>) [SQUAWKING (<i>SSR code</i>)] (<i>type</i>) FROM (<i>departure point</i>) RELEASED AT (<i>significant point, or time, or level</i>) CLEARED TO AND ESTIMATING (<i>clearance limit</i>) (<i>time</i>) AT (<i>level</i>) [EXPECTED APPROACH TIME or NO DELAY EXPECTED] CONTACT AT (<i>time</i>).
HAND OVER	HANDOVER (<i>aircraft call sign</i>) [SQUAWKING (<i>SSR code</i>)] POSITION (<i>aircraft position</i>) (<i>level</i>).
EXPEDITION OF CLEARANCE	a) EXPEDITE CLEARANCE (<i>aircraft call sign</i>) EXPECTED DEPARTURE FROM (<i>place</i>) AT (<i>time</i>); b) EXPEDITE CLEARANCE (<i>aircraft call sign</i>) [ESTIMATED] OVER (<i>place</i>) AT (<i>time</i>) REQUESTS (<i>level or route, etc.</i>).
REDUCED VERTICAL SEPARATION MINIMUM (RVSM) OPERATIONS ... to verbally supplement estimate messages of aircraft non-approved for RVSM or to verbally supplement an automated estimate message exchange that does not automatically transfer information from Item 18 of the flight plan followed by supplementary information, as appropriate ... to communicate the cause of a contingency relating to an aircraft that is unable to conduct RVSM operations due to severe turbulence or other severe meteorological phenomena or equipment failure, as applicable	a) NEGATIVE RVSM [(<i>supplementary information, e.g. State aircraft</i>)]; b) UNABLE RVSM DUE TURBULENCE (or EQUIPMENT, as applicable).

- (b) When, in accordance with ATS.TR.120, communications between air traffic services units or sectors are effected in a mutually agreed language other than English, the air traffic services provider(s) should coordinate to develop and use a phraseology for coordination between such units or sectors.

ATS.TR.235 ATC clearances

Commission Implementing Regulation (EU) 2020/469

- (a) ATC clearances shall be based solely on the requirements for providing air traffic control service.
- (1) Clearances shall be issued solely for expediting and separating air traffic and be based on known traffic conditions which affect safety in aircraft operation. Such traffic conditions include not only aircraft in the air and on the manoeuvring area over which control is being exercised, but also any vehicular traffic or other obstructions not permanently installed on the manoeuvring area in use.
 - (2) Air traffic control units shall issue such ATC clearances as necessary to prevent collisions and to expedite and maintain an orderly flow of air traffic.

- (3) ATC clearances shall be issued early enough to ensure that they are transmitted to the aircraft in sufficient time for it to comply with them.
 - (4) When the pilot-in-command of an aircraft informs an air traffic control unit that an ATC clearance is not satisfactory, the air traffic control unit shall issue an amended clearance, if practicable.
 - (5) When vectoring or assigning a direct routing not included in the flight plan, which takes an IFR flight off published ATS route or instrument procedure, an air traffic controller providing ATS surveillance service shall issue clearances such that the prescribed obstacle clearance exists at all times until the aircraft reaches the point where the pilot re-joins the flight plan route, or joins a published ATS route or instrument procedure.
- (b) Contents of clearances
- An ATC clearance shall indicate:
- (1) aircraft identification as shown in the flight plan;
 - (2) clearance limit;
 - (3) route of flight:
 - (i) the route of flight shall be detailed in each clearance when deemed necessary;
 - (ii) the phrase 'cleared flight planned route' shall not be used when granting a re-clearance;
 - (4) level or levels of flight for the entire route or part thereof and changes of levels if required;
 - (5) any necessary instructions or information on other matters, such as ATFM departure slot if applicable, approach or departure manoeuvres, communications and the time of expiry of the clearance.
- (c) In order to facilitate the delivery of the elements in point (b), an air traffic services provider shall assess the necessity for establishing standard departure and arrival routes and associated procedures to facilitate the:
- (1) safe, orderly and expeditious flow of air traffic;
 - (2) description of the route and procedure in ATC clearances.
- (d) Clearances for transonic flight
- (1) The ATC clearance relating to the transonic acceleration phase of a supersonic flight shall extend at least to the end of that phase.
 - (2) The ATC clearance relating to the deceleration and descent of an aircraft from supersonic cruise to subsonic flight shall seek to provide for uninterrupted descent, at least during the transonic phase.
- (e) Changes in clearance regarding route or level
- (1) When issuing a clearance covering a requested change in route or level, the exact nature of the change shall be included in the clearance.
 - (2) When traffic conditions will not permit clearance of a requested change, the word 'UNABLE' shall be used. When warranted by circumstances, an alternative route or level shall be offered.

(f) Conditional clearances

Conditional phrases, such as ‘behind landing aircraft’ or ‘after departing aircraft’, shall not be used for movements affecting the active runway or runways except when the aircraft or vehicles concerned are seen by the appropriate air traffic controller and pilot. The aircraft or vehicle causing the condition in the clearance issued shall be the first aircraft or vehicle to pass in front of the other aircraft concerned. In all cases, a conditional clearance shall be given in the following order and consist of:

- (1) the call sign;
- (2) the condition;
- (3) the clearance;
- (4) a brief reiteration of the condition.

(g) Read-back of clearances, instructions and safety-related information

- (1) The air traffic controller shall listen to the read-back concerning safety-related parts of ATC clearances and instructions as specified in points SERA.8015(e)(1) and (2) of the Annex to Implementing Regulation (EU) No 923/2012, to ascertain that the clearance or instruction, or both, have been correctly acknowledged by the flight crew and shall take immediate action to correct any discrepancies revealed by the read-back.
- (2) Voice read-back of CPDLC messages shall not be required unless otherwise specified by the air traffic services provider.

(h) Coordination of clearances

An ATC clearance shall be coordinated between air traffic control units to cover the entire route of an aircraft or a specified portion thereof as follows.

- (1) An aircraft shall be cleared for the entire route to the aerodrome of first intended landing in either of the following situations:
 - (i) when it has been possible, prior to departure, to coordinate the clearance between all the units under whose control the aircraft will come;
 - (ii) when there is reasonable assurance that prior coordination will be effected between those units under whose control the aircraft will subsequently come.
- (2) When coordination as in point (1) has not been achieved or is not anticipated, the aircraft shall be cleared only to that point where coordination is reasonably assured; prior to reaching such point, or at such point, the aircraft shall receive further clearance, holding instructions being issued as appropriate.
- (3) When prescribed by the air traffic services unit, aircraft shall contact a downstream air traffic control unit, for the purpose of receiving a downstream clearance prior to the transfer of control point.
 - (i) Aircraft shall maintain the necessary two-way communication with the current air traffic control unit whilst obtaining a downstream clearance.
 - (ii) A clearance issued as a downstream clearance shall be clearly identifiable as such to the pilot.

- (iii) Unless coordinated, downstream clearances shall not affect the aircraft's original flight profile in any airspace, other than that of the air traffic control unit responsible for the delivery of the downstream clearance.
- (4) When an aircraft intends to depart from an aerodrome within a control area to enter another control area within a period of 30 minutes, or such other specific period of time as has been agreed between the area control centres concerned, coordination with the subsequent area control centre shall be effected prior to issuance of the departure clearance.
- (5) When an aircraft intends to leave a control area for flight outside controlled airspace, and will subsequently re-enter the same or another control area, a clearance from the point of departure to the aerodrome of first intended landing may be issued. Such clearance or revisions thereto shall apply only to those portions of the flight conducted within controlled airspace.

GM1 ATS.TR.235 ATC clearances

ED Decision 2020/008/R

The issuance of ATC clearances by air traffic control units constitutes authority for an aircraft to proceed only in so far as known air traffic is concerned. ATC clearances do not constitute authority to violate any applicable regulations for promoting the safety of flight operations or for any other purpose; neither do clearances relieve a pilot-in-command of any responsibility whatsoever in connection with a possible violation of applicable rules and regulations.

GM1 ATS.TR.235(a)(5) ATC clearances

ED Decision 2020/008/R

ASSURANCE OF OBSTACLE CLEARANCE IN VECTORING

- (a) Prescribed obstacle clearance will exist at all times when an air traffic controller issues clearances at or above the established minimum flight altitudes.
- (b) When an IFR flight is being vectored, the pilot may be unable to determine the aircraft's exact position in respect of obstacles in this area and consequently the altitude which provides the required obstacle clearance.

AMC1 ATS.TR.235(b) ATC clearances

ED Decision 2020/008/R

CONTENTS OF CLEARANCES FOR DEPARTING AIRCRAFT

Clearances for departing aircraft should specify, when necessary for the separation of aircraft:

- (a) direction of take-off and turn after take-off;
- (b) heading or track to be made good before taking up the cleared departure track;
- (c) level to maintain before continuing climb to assigned level;
- (d) time, point and/or rate at which a level change shall be made; and
- (e) any other necessary manoeuvre consistent with safe operation of the aircraft.

GM1 to AMC1 ATS.TR.235(b) ATC clearances

ED Decision 2020/008/R

CORRECTION TO HEADING OR TRACK PRIOR TO TAKING UP THE CLEARED DEPARTURE TRACK

‘Track to be made good’ means that the pilot should correct for the wind effect and to fly a heading that would ensure keeping that track.

AMC2 ATS.TR.235(b) ATC clearances

ED Decision 2020/008/R

CONTENTS OF STANDARD CLEARANCES FOR DEPARTING AIRCRAFT

Standard clearances for departing aircraft should contain the following items:

- (a) aircraft identification;
- (b) clearance limit (normally destination aerodrome);
- (c) designator of the assigned SID, if applicable;
- (d) cleared level;
- (e) allocated SSR code; and
- (f) any other necessary instructions or information not contained in the SID description, e.g. instructions relating to change of frequency.

GM1 to AMC2 ATS.TR.235(b) ATC clearances

ED Decision 2020/008/R

CONTENTS OF STANDARD CLEARANCES FOR DEPARTING AIRCRAFT — COMMUNICATION FAILURE

- (a) Clearances for departing aircraft may specify a cleared level other than that indicated in the filed flight plan for the en-route phase of flight, without a time or geographical limit for the cleared level. Such clearances will normally be used to facilitate the application of tactical control methods by air traffic control units, normally through the use of an ATS surveillance system.
- (b) Where clearances for departing aircraft which contain no time or geographical limit for a cleared level are utilised, the action to be taken by an aircraft experiencing air-ground communication failure in the event that the aircraft has been radar-vectorised away from the route specified in its current flight plan, should be prescribed on the basis of a regional air navigation agreement and included in the SID description or published in AIPs.

AMC3 ATS.TR.235(b) ATC clearances

ED Decision 2020/008/R

CLEARANCES FOR ARRIVING IFR FLIGHTS

An IFR flight should neither be cleared for an initial approach below the appropriate minimum altitude as specified by the State concerned nor descend below that altitude unless:

- (a) the pilot has reported passing an appropriate point defined by a navigation aid or as a waypoint;
or

- (b) the pilot reports that the aerodrome is and can be maintained in sight; or
- (c) the aircraft is conducting a visual approach; or
- (d) the air traffic controller has determined the aircraft's position through the use of an ATS surveillance system, and a lower minimum altitude has been specified for use when providing ATS surveillance services.

AMC4 ATS.TR.235(b) ATC clearances

ED Decision 2020/008/R

CONTENTS OF STANDARD CLEARANCES FOR ARRIVING AIRCRAFT

Standard clearances for arriving aircraft should contain the following items:

- (a) aircraft identification;
- (b) designator of the assigned STAR if applicable;
- (c) runway-in-use, except when part of the STAR description;
- (d) cleared level; and
- (e) any other necessary instructions or information not contained in the STAR description, e.g. change of communications.

AMC1 ATS.TR.235(b)(2) ATC clearances

ED Decision 2020/008/R

SPECIFICATION OF CLEARANCE LIMIT

A clearance limit should be described by specifying the name of an appropriate significant point, or aerodrome, or controlled airspace boundary.

GM1 to AMC1 ATS.TR.235(b)(2) ATC clearances

ED Decision 2020/008/R

SPECIFICATION OF CLEARANCE LIMIT

- (a) When prior coordination has been effected with units under whose control the aircraft will subsequently come, or if there is reasonable assurance that it can be effected a reasonable time prior to their assumption of control, the clearance limit should be the destination aerodrome or, if not practicable, an appropriate intermediate point, and coordination should be expedited so that a clearance to the destination aerodrome may be issued as soon as possible.
- (b) If an aircraft has been cleared to an intermediate point in adjacent controlled airspace, the appropriate air traffic control unit will then be responsible for issuing, as soon as practicable, an amended clearance to the destination aerodrome.
- (c) When the destination aerodrome is outside controlled airspace, the air traffic control unit responsible for the last controlled airspace through which an aircraft will pass should issue the appropriate clearance for flight to the limit of that controlled airspace.

GM1 ATS.TR.235(b)(3)(i) ATC clearances

ED Decision 2020/008/R

The phrase 'cleared flight planned route' may be used to describe any route or portion thereof, provided the route or portion thereof is identical to that filed in the flight plan and sufficient routing details are given to definitely establish the aircraft on its route. The phrases 'cleared (designation) departure' or 'cleared (designation) arrival' may be used when standard departure or arrival routes have been established and published in AIPs.

AMC1 ATS.TR.235(b)(4) ATC clearances

ED Decision 2020/008/R

INSTRUCTIONS IN CLEARANCES RELATING TO LEVELS

Instructions included in clearances relating to levels should consist of:

- (a) cruising level(s) or, for cruise climb, a range of levels, and, if necessary, the point to which the clearance is valid with regard to the level(s);
- (b) levels at which specified significant points are to be crossed, when necessary;
- (c) the place or time for starting climb or descent, when necessary;
- (d) the rate of climb or descent, when necessary; and
- (e) detailed instructions concerning departure or approach levels, when necessary.

GM1 ATS.TR.235(b)(4) ATC clearances

ED Decision 2020/008/R

ASSIGNMENT OF FLIGHT LEVELS FOR CONTROLLED FLIGHTS

- (a) Except when traffic conditions and coordination procedures permit authorisation of cruise climb, an air traffic control unit should normally authorise only one level for an aircraft beyond its control area, i.e. that level at which the aircraft will enter the next control area whether contiguous or not. It is the responsibility of the accepting control unit to issue clearance for further climb as appropriate. When relevant, aircraft will be advised to request en-route any cruising level changes desired.
- (b) In so far as practicable, cruising levels of aircraft flying to the same destination should be assigned in a manner that will be correct for an approach sequence at destination.
- (c) An aircraft at a cruising level should normally have priority over other aircraft requesting that cruising level. When two or more aircraft are at the same cruising level, the preceding aircraft should normally have priority.

GM1 ATS.TR.235(b)(5) ATC clearances

ED Decision 2020/008/R

CONTENT OF THE CLEARANCES — TIME OF EXPIRY

The time of expiry of the clearance indicates the time after which the clearance will be automatically cancelled if the flight has not been commenced.

GM1 ATS.TR.235(c) ATC clearances

ED Decision 2020/008/R

ESTABLISHMENT AND PROCEDURES FOR STANDARD ARRIVAL AND DEPARTURE ROUTES

Guidance related to the establishment of standard departure and arrival routes and associated procedures is available in ICAO Doc 9426 'ATS Planning Manual' (Chapter 4, Appendix A).

AMC1 ATS.TR.235(d) ATC clearances

ED Decision 2020/008/R

CLEARANCES FOR TRANSONIC FLIGHT

- (a) Air traffic control units should, whenever practicable, deliver clearance for the transonic acceleration phase to aircraft intending supersonic flight prior to departure.
- (b) During the transonic and supersonic phases of a flight, amendments to the clearance should be kept to a minimum and should take due account of the operational limitations of the aircraft in these flight phases.

GM1 ATS.TR.235(e) ATC clearances

ED Decision 2020/008/R

CHANGE IN CLEARANCE REGARDING ROUTE

The nature of the change should include a description of the route and levels to the point where it joins the previously cleared route, or, if the aircraft will not rejoin the previous route, to the destination.

GM2 ATS.TR.235(e) ATC clearances

ED Decision 2020/008/R

CHANGE IN CLEARANCE REGARDING CRUISING LEVEL

If it is necessary to change the cruising level of an aircraft operating along an established ATS route extending partly within and partly outside controlled airspace and where the respective series of cruising levels are not identical, the change should, whenever possible, be effected within controlled airspace.

GM1 ATS.TR.235(g)(2) ATC clearances

ED Decision 2020/008/R

READ-BACK OF CPDLC MESSAGES

When so indicated by local safety assessments, the air traffic services provider may require that the receipt of some of the CPDLC message types (in particular those addressing trajectory changes) is acknowledged by voice.

GM1 ATS.TR.235(h)(1) ATC clearances

ED Decision 2020/008/R

CLEARANCE UPDATE

Where a clearance is issued covering the initial part of the flight solely as a means of expediting departing traffic, the succeeding en-route clearance will be as specified in point (h)(1) of ATS.TR.235

even though the aerodrome of first intended landing is under the jurisdiction of an ACC other than the one issuing the en-route clearance.

GM1 ATS.TR.235(h)(3)(i) ATC clearances

ED Decision 2020/008/R

AIR-GROUND COMMUNICATION FOR DELIVERY OF DOWNSTREAM CLEARANCES

Where practicable, and where data link communications are used to facilitate downstream clearance delivery, two-way voice communications between the pilot and the air traffic control unit providing the downstream clearance should be available.

ATS.TR.237 Dynamic reconfiguration of the U-space airspace

Regulation (EU) 2021/665

Air traffic control units shall:

- (a) temporarily limit the area within the designated U-space airspace where UAS operations can take place in order to accommodate short-term changes in manned traffic demand by adjusting the lateral and vertical limits of the U-space airspace;
- (b) ensure that the relevant U-space service providers and, where applicable, single common information service providers are notified in a timely and effective manner of the activation, deactivation and temporary limitations of the designated U-space airspace.

AMC1 ATS.TR.237(a) Dynamic reconfiguration of the U-space airspace

ED Decision 2022/023/R

IMPACT OF DYNAMIC AIRSPACE RECONFIGURATION ON UAS OPERATIONS

Air traffic control units should only apply dynamic reconfiguration of the U-space airspace if there is a risk of collision between manned and unmanned aircraft, causing the revised flight authorisation of UASs, or potentially causing the forced landing of unmanned aircraft.

AMC2 ATS.TR.237(a) Dynamic reconfiguration of the U-space airspace

ED Decision 2022/023/R

PRIORITY TO SPECIAL OPERATIONS

When intending to apply dynamic reconfiguration of the U-space airspace, air traffic control units should give priority to special operations, as defined in Article 4 of [Regulation \(EU\) No 923/2012](#), whether performed by UASs or manned aircraft.

GM1 ATS.TR.237(a) Dynamic reconfiguration of the U-space airspace

ED Decision 2022/023/R

TIMELY RECEIPT OF INFORMATION

Air traffic control units are expected to coordinate with U-space service providers to ensure they will receive the information about UAS special operations in a timely manner so that the air traffic control units can prioritise the traffic in the affected U-space airspace.

GM2 ATS.TR.237(a) Dynamic reconfiguration of the U-space airspace

ED Decision 2022/023/R

PROPORTIONATE RESPONSE

- (a) For the purpose of supporting a more flexible use of the available airspace and to reduce the likelihood of forced landings, as airspace volumes are three-dimensional, Member States may consider dynamic reconfiguration of the U-space airspace in a three-dimensional multi-phased manner.
- (b) The following multi-phased reconfiguration may be considered:
 - (1) Vertical limitation: limit the ceiling of UAS operations to a level such as the lowest limit of the applicable obstacle limitation surface (i.e. inner horizontal surface), when available. Lowering the ceiling of the U-space airspace would allow for continuous segregated operations as manned aircraft will fly above UASs. Keeping the U-space airspace partially active and usable for a prolonged period of time would safeguard the operation of UASs that fly at a lower altitude.
 - (2) Lateral limitation: deactivation of a U-space airspace section, where manned aircraft operations take place, down to ground. UAS flights outside the deactivated portion may continue. Hereby, the impact on UAS operations is limited to what is necessary.
 - (3) Full deactivation: fully deactivating the U-space airspace.
- (c) As a result of the vertical and lateral limitation phases, UASs in flight will comply with updated UAS flight authorisations, as applicable, or immediately approach a predefined safety landing point, while because of the full deactivation phase they will proceed to such landing point. Safety landing points are appropriately selected by the UAS operator and submitted during UAS flight authorisation to ensure a quick landing without endangering people or surrounding property on the ground or damaging the UAS hardware.

AMC1 ATS.TR.237(b) Dynamic reconfiguration of the U-space airspace

ED Decision 2022/023/R

TIMELY NOTIFICATION

Air traffic control units should coordinate with the U-space service providers concerned to ensure they will be notified as early as possible of the dynamic reconfiguration of the U-space airspace, so that the UAS operators may anticipate and apply any required action.

GM1 ATS.TR.237(b) Dynamic reconfiguration of the U-space airspace

ED Decision 2022/023/R

EFFECTIVE COORDINATION

- (a) Establishing a preset, minimum advance notice (in terms of time) could be difficult in many instances; however, analogy may be found in this respect in EUROCAE ED-269 'Minimum Operational Performance Standard for UAS Geo-Fencing' (published on 1 June 2020), which specifies the minimum performance expected from a geofencing function to ensure that it will perform its intended sub-functions satisfactorily under all conditions normally encountered in a routine aeronautical operation.
- (b) EUROCAE ED-269 indicates the issue of a caution alert to the UAS operators when the location where the operations are taking place is to become forbidden soon and will have to be exited soon enough to enable exit before active restriction; for example; considering the distance to fly back to the authorised limit (or distance to exit) divided by the anticipated ground speed to do so. A minimum value of 2 minutes is suggested. It is also recommended to have an advisory alert before the caution alert (either 10 minutes or 5 times the caution anticipation time).
- (c) In any case, when data that results from the dynamic airspace reconfiguration is made available as part of the common information service, it may include starting/ending time of the reconfiguration; otherwise it is intended to be immediately applicable, until further notice.
- (d) Except for emergency situations, coordination between air traffic control units and U-space service providers should allow for the completion of any authorised UAS flight that has started already, possibly through a revised UAS flight authorisation. In circumstances where the air traffic control unit considers that this would inappropriately postpone the airspace reconfiguration, UAS operators should at least be allowed sufficient time to reposition unmanned aircraft according to the adjusted geographical limits of the U-space airspace, or to safely proceed, without delay, to a landing site.

ATS.TR.240 Control of persons and vehicles at controlled aerodromes

Commission Implementing Regulation (EU) 2020/469

- (a) The movement of persons or vehicles, including towed aircraft, on the manoeuvring area of an aerodrome shall be controlled by the aerodrome control tower as necessary to avoid hazard to them or to aircraft landing, taxiing or taking off.
- (b) In conditions where low-visibility procedures are in operation:

- (1) persons and vehicles operating on the manoeuvring area of an aerodrome shall be restricted to the essential minimum, and particular regard shall be given to the requirements to protect the critical and sensitive area or areas of radio navigation aids;
 - (2) subject to the provisions in point (c), the method or methods to separate vehicles and taxiing aircraft shall be as specified by the air traffic services provider and approved by the competent authority taking into account the aids available;
 - (3) when mixed ILS and MLS Category II or Category III precision instrument operations are taking place to the same runway continuously, the more restrictive ILS or MLS critical and sensitive areas shall be protected.
- (c) Emergency vehicles proceeding to the assistance of an aircraft in distress shall be afforded priority over all other surface movement traffic.
- (d) Subject to the provisions in point (c), vehicles on the manoeuvring area shall be required to comply with the following rules:
- (1) vehicles and vehicles towing aircraft shall give way to aircraft which are landing, taking off or taxiing;
 - (2) vehicles shall give way to other vehicles towing aircraft;
 - (3) vehicles shall give way to other vehicles in accordance with air traffic services unit instructions;
 - (4) notwithstanding the provisions of points (1), (2) and (3), vehicles and vehicles towing aircraft shall comply with instructions issued by the aerodrome control tower.

AMC1 ATS.TR.240(a) Control of persons and vehicles at controlled aerodromes

ED Decision 2020/008/R

CONTROL OF OTHER THAN AIRCRAFT TRAFFIC ON THE MANOEUVRING AREA

- (a) The movement of pedestrians or vehicles on the manoeuvring area should be subject to authorisation by the aerodrome control tower. Persons, including drivers of all vehicles, should be required to obtain authorisation from the aerodrome control tower before entry to the manoeuvring area. Notwithstanding such an authorisation, entry to a runway or runway strip or change in the operation authorised should be subject to a further specific authorisation by the aerodrome control tower.
- (b) When an aircraft is landing or taking off, the air traffic controller should not permit vehicles to hold closer to the runway-in-use than:
- (1) at a taxiway/runway intersection — at a runway-holding position; and
 - (2) at a location other than a taxiway/runway intersection — at a distance equal to the separation distance of the runway-holding position.

AMC2 ATS.TR.240(a) Control of persons and vehicles at controlled aerodromes

ED Decision 2020/008/R

UNCERTAINTY ON AIRCRAFT AND/OR VEHICLES POSITION ON THE MANOEUVRING AREA

In the event that the aerodrome air traffic controller becomes aware of an aircraft or vehicle that is lost or uncertain of its position on the manoeuvring area, he or she should immediately take appropriate action to safeguard operations and assist the aircraft or vehicle concerned in determining its position.

GM1 ATS.TR.240(b)(2) Control of persons and vehicles at controlled aerodromes

ED Decision 2020/008/R

CONTROL OF PERSONS AND VEHICLES AT AERODROMES

In prescribing the separation method(s) between vehicles and taxiing aircraft, the availability of lighting, markings, signals and signage should normally be taken into account.

GM1 ATS.TR.240(c) Control of persons and vehicles at controlled aerodromes

ED Decision 2020/008/R

PRIORITY TO EMERGENCY VEHICLES

When emergency vehicles are proceeding to the assistance of an aircraft in distress, all other movement of surface traffic should, to the extent practicable, be halted until it is determined that the progress of the emergency vehicles will not be impeded.

ATS.TR.245 Use of surface movement surveillance equipment at aerodromes

Commission Implementing Regulation (EU) 2020/469

Where deemed necessary, in the absence of visual observation of all or part of the manoeuvring area or to supplement visual observation, advanced surface movement guidance and control systems (A-SMGCS) or other suitable surveillance equipment, shall be utilised by the air traffic services unit in order to:

- (a) monitor the movements of aircraft and vehicles on the manoeuvring area;
- (b) provide directional information to pilots and vehicle drivers as necessary;
- (c) provide advice and assistance for the safe and efficient movement of aircraft and vehicles on the manoeuvring area.

GM1 ATS.TR.245 Use of surface movement surveillance equipment at aerodromes

ED Decision 2020/008/R

FUNCTIONS OF SURFACE MOVEMENT RADAR IN SURFACE MOVEMENT CONTROL

The information displayed on an SMR display may be used to assist in:

- (a) monitoring of aircraft and vehicles on the manoeuvring area for compliance with clearances and instructions;
- (b) determining that a runway is clear of traffic prior to a landing or take-off;
- (c) providing information on essential local traffic on or near the manoeuvring area;
- (d) determining the location of aircraft and vehicles on the manoeuvring area;
- (e) providing directional taxi information to aircraft when requested by the pilot or deemed necessary by the air traffic controller. Except under special circumstances, e.g. emergencies, such information should not be issued in the form of specific heading instructions; and
- (f) providing assistance and advice to emergency vehicles.

GM2 ATS.TR.245 Use of surface movement surveillance equipment at aerodromes

ED Decision 2020/008/R

FUNCTIONS OF ADVANCED SURFACE MOVEMENT GUIDANCE AND CONTROL SYSTEMS — A-SMGCS IN SURFACE MOVEMENT CONTROL

When authorised and subject to conditions prescribed by the competent authority, the information provided on an A-SMGCS display may be used for the purpose of:

- (a) determining the location of aircraft on the movement area and vehicles on the manoeuvring area. Where visual observation by the aerodrome air traffic controller is not possible, or whenever deemed beneficial by the aerodrome air traffic controller, the information provided by A-SMGCS may be used to replace visual observation;
- (b) monitoring of aircraft and vehicles on the manoeuvring area for compliance with clearances and instructions;
- (c) determining that a runway is clear of traffic or assisting in the assessment that a runway will be clear of traffic prior to a landing or take-off;
- (d) providing information on essential local traffic on or near the manoeuvring area;
- (e) providing directional taxi information to aircraft when requested by the pilot or deemed necessary by the air traffic controller. Such information should not be issued in the form of specific heading instructions (except in special circumstances, e.g. emergencies); and
- (f) providing assistance and advice to emergency vehicles.

ATS.TR.250 Essential traffic and essential local traffic information

Commission Implementing Regulation (EU) 2020/469

- (a) Essential traffic information shall be given to controlled flights concerned whenever they constitute essential traffic to each other.
- (b) Essential local traffic information known to the air traffic controller shall be given without delay to departing and arriving aircraft concerned.

AMC1 ATS.TR.250(a) Essential traffic and essential local traffic information

ED Decision 2020/008/R

ESSENTIAL TRAFFIC INFORMATION — CONTENT

Essential traffic information should include the following information if relevant and available:

- (a) direction of flight of aircraft concerned;
- (b) type and wake turbulence category of aircraft concerned;
- (c) level of aircraft concerned; and
- (d) one of the following:
 - (1) estimated time over the reporting point nearest to where the level will be crossed; or
 - (2) relative bearing of the aircraft concerned in terms of the 12-hour clock as well as distance from the conflicting traffic; or
 - (3) actual or estimated position of the aircraft concerned.

GM1 ATS.TR.250(a) Essential traffic and essential local traffic information

ED Decision 2020/008/R

ESSENTIAL TRAFFIC INFORMATION — CONTENT

Subject to provisions in point (b) of [ATS.TR.210](#), air traffic control units are required to provide separation between IFR flights in airspace classes A to E, and between IFR and VFR flights in classes B and C. Air traffic control units are not required to provide separation between VFR flights, except within airspace class B. Therefore, IFR or VFR flights may constitute essential traffic to IFR traffic, and IFR flights may constitute essential traffic to VFR traffic. However, a VFR flight would not constitute essential traffic to other VFR flights except within class B airspace.

AMC1 ATS.TR.250(b) Essential traffic and essential local traffic information

ED Decision 2020/008/R

ESSENTIAL LOCAL TRAFFIC INFORMATION

- (a) Information on essential local traffic should be issued in a timely manner, either directly or through the unit providing approach control service when, in the judgement of the aerodrome

air traffic control, such information is necessary in the interest of safety, or when requested by aircraft.

- (b) Essential local traffic should be described so as to be easily identified.

ATS.TR.255 Operations on parallel or near-parallel runways

Commission Implementing Regulation (EU) 2020/469

When independent or dependent operations on instrument approach to or departure from parallel or near-parallel runways are conducted, procedures shall be established by the air traffic services provider and approved by the competent authority.

AMC1 ATS.TR.255 Operations on parallel or near-parallel runways

ED Decision 2020/008/R

REQUIREMENTS AND PROCEDURES FOR INDEPENDENT PARALLEL DEPARTURES

- (a) Parallel runways may be used for independent instrument departures as follows:
- (1) both runways are used exclusively for departures (independent departures); or
 - (2) one runway is used exclusively for departures while the other runway is used for a mixture of arrivals and departures (semi-mixed operation); or
 - (3) both runways are used for mixed arrivals and departures (mixed operation).
- (b) Independent IFR departures should only be conducted from parallel runways when the conditions listed below are met:
- (1) the runway centre lines are spaced by a minimum distance of 760 m (2 500 ft) (as also specified in CS ADR-DSN.B.055 'Minimum distance between parallel instrument runways' in EASA ED Decision 2014/013/R 'Certification Specifications and Guidance Material For Aerodromes Design', as amended);
 - (2) the nominal departure tracks diverge by at least:
 - (i) 15 degrees immediately after take-off; or
 - (ii) 10 degrees where:
 - (A) both aircraft are flying an RNAV or RNP instrument departure; and
 - (B) the turn commences no more than 3.7 km (2.0 NM) from the departure end of the runway;
 - (3) a suitable ATS surveillance system capable of identification of the aircraft within 1.9 km (1.0 NM) from the end of the runway is available; and
 - (4) ATS operational procedures ensure that the required track divergence is achieved.

AMC2 ATS.TR.255 Operations on parallel or near-parallel runways

ED Decision 2020/008/R

REQUIREMENTS AND PROCEDURES FOR INDEPENDENT PARALLEL APPROACHES

Independent parallel approaches should only be conducted to parallel runways when the following conditions are met:

- (a) separate air traffic controllers are responsible for the sequencing and spacing of arriving aircraft to each runway;
- (b) as early as practicable after an aircraft has established communication, the approach control unit advises the aircraft that independent parallel approaches are in force;
- (c) the following ATS surveillance criteria are met:
 - (1) for runway centreline spacing less than 1 310 m (4 300 ft) but not less than 1 035 m (3 400 ft), an ATS surveillance system with:
 - (i) a minimum accuracy as follows:
 - (A) for SSR, an azimuth accuracy of 0.06 degrees (one sigma); or
 - (B) for MLAT or ADS-B, an accuracy of 30 m (100 ft);
 - (ii) an update of 2.5 seconds or less; and
 - (iii) a high-resolution display providing position prediction and deviation alert;
 - (2) for runway centreline spacing less than 1 525 m (5 000 ft) but not less than 1 310 m (4 300 ft), provided that it is determined that the safety of aircraft operations is not adversely affected, an ATS surveillance system:
 - (i) with performance specifications equal to or better than:
 - (A) for SSR, a demonstrated minimum accuracy of 0.3 degrees (one sigma); or
 - (B) for MLAT or ADS-B, a demonstrated performance capability equivalent to or better than the SSR requirement;
 - (ii) with an update of 5 seconds or less;
 - (3) for runway centreline spacing of 1 525 m (5 000 ft) or more, a surveillance system with:
 - (i) a minimum SSR azimuth accuracy of 0.3 degrees (one sigma), or for MLAT or ADS-B, a demonstrated performance capability equivalent to or better than the SSR requirement; and
 - (ii) an update of 5 seconds or less;
- (d) the instrument approach procedure that aligns the aircraft with the extended runway centre line is one of the following:
 - (1) a precision approach procedure;
 - (2) an approach with vertical guidance (APV) designed using the RNP AR APCH specification where:
 - (i) the RNP value for B, and the RNP value for C, if that segment of the approach is within the horizontal separation minimum of a parallel approach, does not exceed one quarter of the distance between runway centre lines (A) (see Figure 51); and

- (ii) the RNP value for B, and the RNP value for C, if that part of the approach is within the horizontal separation minimum of a parallel approach, does not exceed $(A-D)/2$ (see Figure 51);

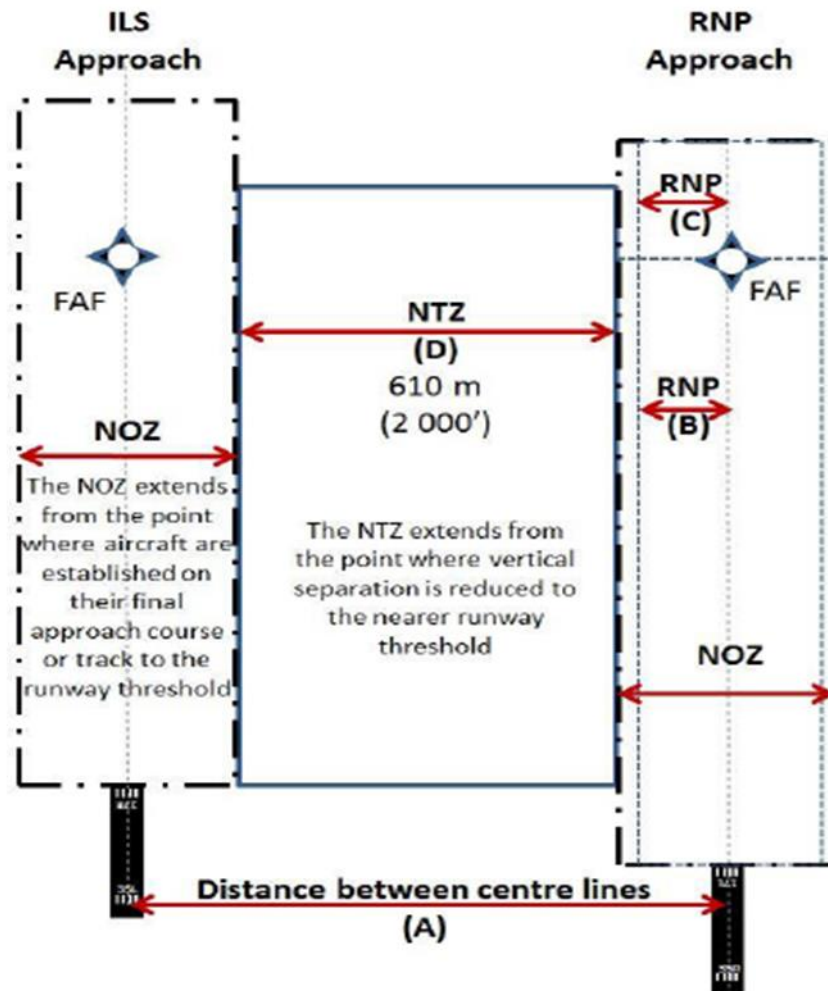

Figure 51: Distance between centre lines, NTZ and NOZ

- (3) an APV procedure designed using either the RNP APCH or RNP AR APCH navigation specification, provided that:
- (i) an appropriate documented safety assessment has shown that an acceptable level of safety can be met;
 - (ii) operations are approved by the competent authority; and
 - (iii) the instrument approach is demonstrated to protect the NTZ from infringement during normal operations;
- (e) the nominal tracks of the missed approach procedures diverge by at least 30 degrees;
- (f) an obstacle survey and evaluation is completed, as appropriate, for the areas adjacent to the final approach segments;

- (g) aircraft are advised as early as possible, of the assigned runway, instrument approach procedure and any additional information considered necessary to confirm correct selection;
- (h) the final approach course or track is intercepted by use of either:
 - (1) a published arrival and approach procedures that intercept with the IAF or the intermediate approach fix (IF); or
 - (2) vectoring, provided that:
 - (i) the final vector meets the following conditions:
 - (A) enable the aircraft to intercept at an angle not greater than 30 degrees;
 - (B) provide at least 1.9 km (1.0 NM) straight and level flight prior to the final approach course or track intercept; and
 - (C) enable the aircraft to be established on the final approach course or track in level flight for at least 3.7 km (2.0 NM) prior to intercepting the glide path or vertical path for the selected instrument approach procedure;
 - (ii) when assigning the final vector, the aircraft is advised of:
 - (A) the runway to which the approach is being made;
 - (B) its position relative to a fix on the final approach course or track;
 - (C) the altitude to be maintained until established on the final approach course or track, to the glide path or vertical path intercept point; and
 - (D) if required, clearance for the appropriate approach.
- (i) an NTZ at least 610 m (2 000 ft) wide is established equidistant between extended runway centre lines and is depicted on the ATS surveillance system situation display;
- (j) a minimum of a nominal 300 m (1 000 ft) vertical separation or, subject to ATS surveillance system capabilities, a minimum of 5.6 km (3.0 NM) horizontal separation is provided between aircraft on adjacent approaches until the aircraft are established inbound on a final approach course or track, or on an RNP AR APCH approach, and within the normal operating zone (NOZ);
- (k) a minimum of 5.6 km (3.0 NM) horizontal separation, or a minimum of 4.6 km (2.5 NM) horizontal separation if so determined in accordance with point (a) of ATS.TR.215, is provided between aircraft established on the same final approach course or track, unless increased longitudinal separation is required due to wake turbulence;
- (l) the approaches to each runway are monitored with an ATS surveillance system by separate air traffic controllers (referred to as monitoring controllers) different than those in point (a) above for each runway, or, if determined by a safety assessment and approved by the competent authority, by a single monitoring controller for no more than two runways:
 - (1) on dedicated radio channels, or when no such channels are available to the monitoring controller until landing, it is assured that:
 - (i) transfer of communication of aircraft to the respective aerodrome air traffic controller's channel is effected before either of the two aircraft on adjacent final approach tracks intercepts the glide path or vertical path for the selected instrument approach procedure; and

- (ii) the air traffic controller(s) monitoring the approaches to each runway are provided with the capability to override transmissions of aerodrome control on the respective radio channels for each arrival flow;
- (2) so that when the nominal 300 m (1 000 ft) vertical separation is reduced:
 - (i) the applicable minimum longitudinal separation between aircraft on the same final approach course or track is maintained; and
 - (ii) aircraft do not penetrate the depicted NTZ by issuing instructions as follows:
 - (A) when it is observed that an aircraft overshoots the turn-on or continues on a track which will penetrate the NTZ, the aircraft is instructed to return immediately to the correct track; or
 - (B) when an aircraft is observed penetrating the NTZ, the aircraft on the adjacent final approach course or track is instructed to immediately climb and turn to the assigned altitude/height and heading (break-out procedure) in order to avoid the deviating aircraft. Where parallel approach obstacle assessment surfaces (PAOAS) criteria are applied for the obstacle assessment, the monitoring controller (see below in point (f)) should not issue the heading instruction to the aircraft below 120 m (400 ft) above the runway threshold elevation, and the heading instruction should not exceed 45 degrees track difference with the final approach course or track;
- (3) the monitoring is provided until:
 - (i) separation as stipulated in point (b)(1) of [AMC3 ATS.TR.210\(c\)\(2\)](#) is applied, provided the established procedures ensure that monitoring controllers are advised whenever such separation is applied; or
 - (ii) the aircraft has landed, or in case of a missed approach, is at least 1.9 km (1.0 NM) beyond the departure end of the runway and adequate separation with any other traffic is established;
- (m) the meteorological conditions under which independent parallel approaches are suspended for runway centre lines which are spaced less than 1 525 m (5 000 ft) are defined by the air traffic services provider and approved by the competent authority.

GM1 to AMC2 ATS.TR.255 Operations on parallel or near-parallel runways

ED Decision 2020/008/R

The information that independent parallel operations are in force may be provided through the ATIS broadcasts.

GM2 to AMC2 ATS.TR.255 Operations on parallel or near-parallel runways

ED Decision 2020/008/R

HIGH-RESOLUTION DISPLAY

With reference to point (c)(1)(iii) of [AMC2 ATS.TR.255](#), a high-resolution display should:

- (a) enable the air traffic controller to determine whether an aircraft is correctly aligned with the intended trajectory;
- (b) depict the NTZ(s);
- (c) be able to display any obstacle that would adversely affect a break-out procedure; and
- (d) accurately reflect the azimuth accuracy prescribed in point (c)(1)(i)(A) of [AMC2 ATS.TR.255](#).

GM3 to AMC2 ATS.TR.255 Operations on parallel or near-parallel runways

ED Decision 2020/008/R

PRECISION APPROACH PROCEDURE

With reference to point (d)(1) of [AMC2 ATS.TR.255](#), the precision approach procedure that aligns the aircraft with the extended runway centre line may include one of the following: ILS, GLS, MLS or SBAS CAT I, when applicable, for the final approach segment.

GM4 to AMC2 ATS.TR.255 Operations on parallel or near-parallel runways

ED Decision 2020/008/R

PRECISION APPROACH PROCEDURE — DEMONSTRATION OF SAFETY

With reference to point (d)(3) of [AMC2 ATS.TR.255](#), the demonstration of the safety of an APV procedure designed using either RNP APCH or RNP AR APCH navigation specification during simultaneous approaches may consider, inter alia:

- (a) the collision risk from normal and residual (not mitigated) atypical errors;
- (b) likelihood of ACAS nuisance alerting during normal operations;
- (c) wake hazard;
- (d) monitoring and available levels of system automation;
- (e) data base management;
- (f) flight management system input and related crew workload;
- (g) impacts of meteorological conditions and other environmental factors; and
- (h) training and published ATC break-out procedures.

GM5 to AMC2 ATS.TR.255 Operations on parallel or near-parallel runways

ED Decision 2020/008/R

SAFETY ASSESSMENT

With reference to point (l) of [AMC2 ATS.TR.255](#), the conduct of safety assessments to enable the monitoring of not more than two runways by a single air traffic controller should review factors such as, but not limited to, complexity, times of operation, traffic mix and density, arrival rate, available levels of system automation, availability of back-up systems, impacts of meteorological conditions and other environmental factors.

GM6 to AMC2 ATS.TR.255 Operations on parallel or near-parallel runways

ED Decision 2020/008/R

MONITORING CONTROLLER

With reference to point (l) of [AMC2 ATS.TR.255](#):

- (a) Independent operations on parallel runways can only be conducted if there are means to ensure that the objectives of the air traffic services would be fulfilled in a manner similar to what the application of separation minima (vertical or horizontal) would achieve.
- (b) Considering the geometry of two aircraft operating simultaneously on the parallel runways, while longitudinal separation is applied between aircraft approaching the same runway, a lateral separation is needed between the aircraft operating on parallel approaches for the most critical scenario: two aircraft at the same time on each final approach.
- (c) To provide the acceptable lateral separation in such circumstances, an NTZ is established. The NTZ is considered to provide the lateral separation from the moment vertical separation between aircraft on adjacent approaches no longer exists until aircraft have landed. The responsibility of air traffic controllers is to closely monitor the progress of the flights and to immediately react when an aircraft deviates towards the NTZ boundary.
- (d) In that sense, the tasks of these air traffic controllers (referred to as ‘monitoring controllers’), are as follows:
 - (1) **to ensure** that the NTZ is not penetrated when vertical separation is reduced;
 - (2) **to instruct** aircraft observed to overshoot the turn-on or to continue on a track which will penetrate the NTZ to return immediately to the correct track;
 - (3) **to ensure** that the applicable minimum longitudinal separation between aircraft on the same final approach course or track is maintained;
 - (4) if no dedicated radio channels are available for the monitoring controllers to control aircraft until landing, **to transfer** communication with the aircraft to the respective channel of the aerodrome air traffic controller before either of the two aircraft on adjacent final approach tracks intercepts the glide path or vertical path for the selected instrument approach procedure. In this case, the controllers monitoring the approaches to each runway are provided with the capability to override transmissions of aerodrome control on the respective radio channels for each arrival flow;

-
- (5) if dedicated radio channels are available for the monitoring controllers **to relay** the landing clearances received from the aerodrome air traffic controller, or when the aerodrome air traffic controller informs that visual separation can be applied, **to transfer** the communications to the aerodrome air traffic controller;
- (6) when an aircraft is observed penetrating the NTZ, **to instruct** the aircraft on the adjacent final approach course or track to immediately climb and turn to an assigned altitude/height and heading (break-out procedures) in order to avoid the deviating aircraft. Where PAOAS criteria are applied for the obstacle assessment, the monitoring controller will not issue the heading instruction to the aircraft below 120 m (400 ft) above the runway threshold elevation, and the heading instruction will not exceed 45 degrees track difference with the final approach course or track; and
- (7) **to terminate** monitoring when either:
- (i) visual separation is applied provided that procedures ensure that both monitoring controllers are advised whenever visual separation is applied; or
 - (ii) the aircraft has landed or, in case of a missed approach, is at least 1 NM beyond the departure end of the runway and adequate separation with other traffic is established.
- (e) When there is a large deviation from the final approach track, communication between the controllers and pilots involved is critical. For independent parallel approaches, monitoring controllers are required, for each runway, with separate control frequencies. The monitoring controller(s) can transmit on either of these frequencies, automatically overriding transmissions by the other aerodrome air traffic controllers, or can use dedicated radio channels, if available. It is essential that a check of the override capability at each monitor position be performed prior to the monitoring controllers assuming responsibility of the position. The air traffic services provider should take steps to ensure that, in the event of a deviation, the monitoring controller will be able to contact the deviating aircraft and the endangered aircraft immediately. This will involve studying the proportion of time during which communications are blocked.
- (f) Monitoring of approaches to no more than two runways by a single monitoring controller may be permitted if determined by a safety assessment and approved by the competent authority, as described below.
- (g) During simultaneous independent approach operations, participating aircraft are established on guidance to instrument approach procedures which have been designed to not interfere with one another. By remaining on their guidance, the aircraft are, by design, not threats to each other, and are considered separated. If either aircraft deviates from its lateral path defined by its assigned instrument approach, separation is no longer assured. To protect against operational errors, system or equipment failures, etc., Simultaneous Operations on Parallel or Near-Parallel Instrument Runways (SOIR) procedures require the monitoring controller to provide intervention as necessary. Monitoring controllers are required to identify and respond to such traffic transgressions in a timely manner to protect proximate traffic and minimise collision risk. Their responsibility is to recognise a deviation from a cleared lateral path, determine a manoeuvre for any nearby traffic that might be threatened by this deviation that will avoid a collision, and transmit this manoeuvre instruction to the threatened aircraft. If there is no threatened traffic, or after the threatened traffic has begun its escape manoeuvre, the monitoring controller will also attempt to instruct the deviating aircraft.
- (h) The time budgeted for recognition by monitoring controller of potential collision during non-nominal events in simultaneous parallel approaches is in the order of seconds. System-

generated alerts to the monitoring controller that can differentiate quickly and accurately between normal and non-nominal situations will be an enabling element of the operation. The region known as NTZ is used to provide air traffic controllers with time to identify that one aircraft on a simultaneous approach may threaten the other and to then take appropriate action to avoid a collision. Normally, a dedicated monitoring controller is assigned to each approach during simultaneous operations. However, since a single NTZ is defined in the space between simultaneous approaches, it may be possible for a single controller to effectively monitor and correct any transgressing aircraft. Approval of an alternate to the otherwise-required approach-specific monitor control positions should consider, as a minimum, the following elements unique to a specific approach pairing:

- (1) Approach geometry complexity:
 - (i) displaced thresholds which cause non-coincident altitudes along the parallel tracks;
 - (ii) use of curved course transitions to final; and
 - (iii) short finals.
- (2) Traffic mix and density:
 - (i) mix of light-heavy traffic necessitating varying longitudinal wake spacing; and
 - (ii) approach speed variations.
- (3) Arrival rate and density:
 - (i) total traffic volume versus approach capacity; and
 - (ii) flow management consistency with traffic demand.
- (4) Available levels of system automation:
 - (i) conformance monitoring tools; and
 - (ii) non-transgression alerting.
- (5) Availability of back-up systems to provide continuity of:
 - (i) communication;
 - (ii) approach navigation (approach technology);
 - (iii) surveillance (independent, redundant sources); and
 - (iv) interdependency of CNS.
- (6) The impacts of local meteorological conditions and other environmental factors:
 - (i) inversion on final that can cause wake vortices to not dissipate;
 - (ii) excessive tailwind;
 - (iii) high cross-winds;
 - (iv) gusty winds; and
 - (v) inconsistent wind patterns (e.g. caused by nearby obstacles or terrain).

GM7 to AMC2 ATS.TR.255 Operations on parallel or near-parallel runways

ED Decision 2020/008/R

SUSPENSION OF INDEPENDENT PARALLEL OPERATIONS DUE TO METEOROLOGICAL CONDITIONS

With reference to point (m) of [AMC2 ATS.TR.255](#):

- (a) The meteorological conditions to be considered include, but are not limited to, the following:
 - (1) wind shear;
 - (2) turbulence;
 - (3) downdrafts; and
 - (4) crosswind and significant meteorological conditions such as thunderstorms, which might otherwise increase deviations from the final approach course or track to the extent that safety may be impaired.
- (b) Guidance relating to meteorological conditions is contained in the ICAO Doc 9643 'Manual on Simultaneous Operations on Parallel or Near-Parallel Instrument Runways (SOIR)'.

AMC3 ATS.TR.255 Operations on parallel or near-parallel runways

ED Decision 2020/008/R

REQUIREMENTS AND PROCEDURES FOR DEPENDENT PARALLEL APPROACHES

Dependent parallel approaches should only be conducted to parallel runways when the following conditions are met:

- (a) separate air traffic controllers are responsible for the sequencing and spacing of arriving aircraft to each runway;
- (b) the runway centre lines are spaced by 915 m (3 000 ft) or more;
- (c) the final approach course or track is intercepted by use of:
 - (1) vectoring; or
 - (2) a published arrival and approach procedures that intercepts with the IAF or the IF.
- (d) an ATS surveillance system with a minimum SSR azimuth accuracy of 0.3 degrees (one sigma), or for MLAT or ADS-B a performance capability equivalent to or better than the SSR requirement can be demonstrated and an update period of 5 seconds or less is available;
- (e) the instrument flight procedure that aligns the aircraft with the extended runway centre line is one of the following:
 - (1) a precision approach procedure;
 - (2) an APV procedure designed using the RNP AR APCH navigation specification, provided that the RNP value for B, and the RNP value for C if that segment of the approach is within the horizontal separation minimum of a parallel approach, does not exceed one quarter of the distance between runway centre lines (A) (See Figure 52);
 - (3) an APV procedure designed using the RNP AR APCH navigation specification that does not meet the provisions in point (2) above or an RNP APCH, provided that:

- (i) an appropriate, documented safety assessment has shown that an acceptable level of safety can be met; and
- (ii) operations are approved by the competent authority;

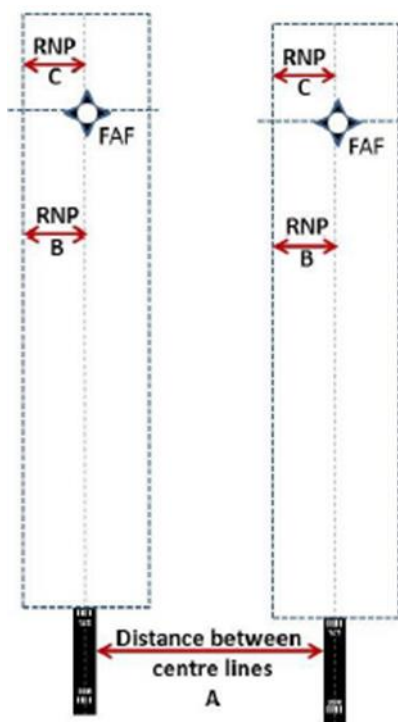

Figure 52: RNP value and distance between centre lines

- (f) aircraft are advised that approaches are in use to both runways;
- (g) the nominal tracks of the missed approach procedures diverge by at least 30 degrees;
- (h) the approach control unit has the capability to override the frequencies used by the aerodrome control tower;
- (i) a minimum of nominal 300 m (1 000 ft) vertical separation or a minimum of 5.6 km (3.0 NM) horizontal separation is provided between aircraft until established on the final approach courses or tracks of parallel approaches;
- (j) the minimum horizontal separation to be provided between aircraft established on the same final approach course or track is 5.6 km (3.0 NM), or 4.6 km (2.5 NM) horizontal separation if so determined in accordance with ATS.TR.215, unless increased longitudinal separation is required due to wake turbulence;
- (k) the minimum horizontal separation to be provided diagonally between successive aircraft on adjacent final approach courses or tracks is:
 - (1) 3.7 km (2.0 NM) between successive aircraft on adjacent final approach courses or tracks more than 2 529 m (8 300 ft) apart (See figure 53); or

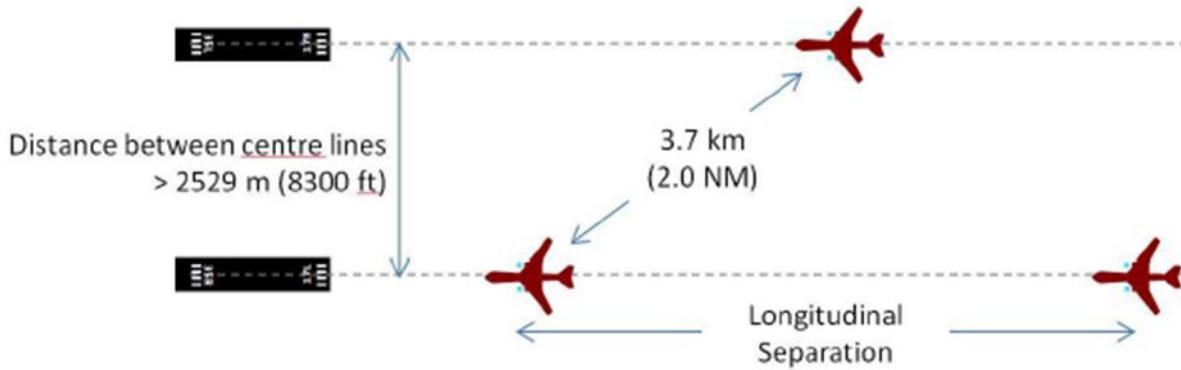

Figure 53: Diagonal separation for distance between centre lines greater than 2 529 m (8 300 ft)

- (2) 2.8 km (1.5 NM) between successive aircraft on adjacent final approach courses or tracks more than 1 097 m (3 600 ft) but not more than 2 529 m (8 300 ft) apart (see Figure 54); or

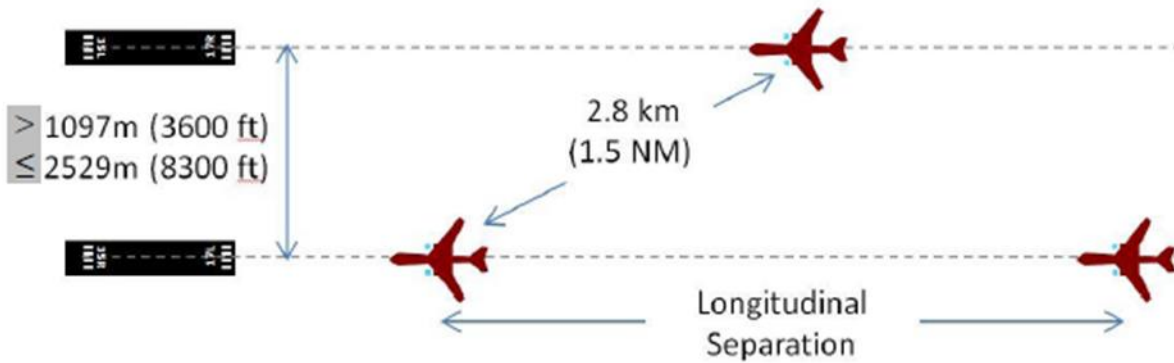

Figure 54: Diagonal separation for distance between centre lines greater than 1 097 m (3 600 ft) but less than or equal to 2 529 m (8 300 ft)

- (3) 1.9 km (1.0 NM) between successive aircraft on adjacent final approach courses or tracks more than 915 m (3 000 ft) but not more than 1 097 m (3 600 ft) apart (see Figure 55).

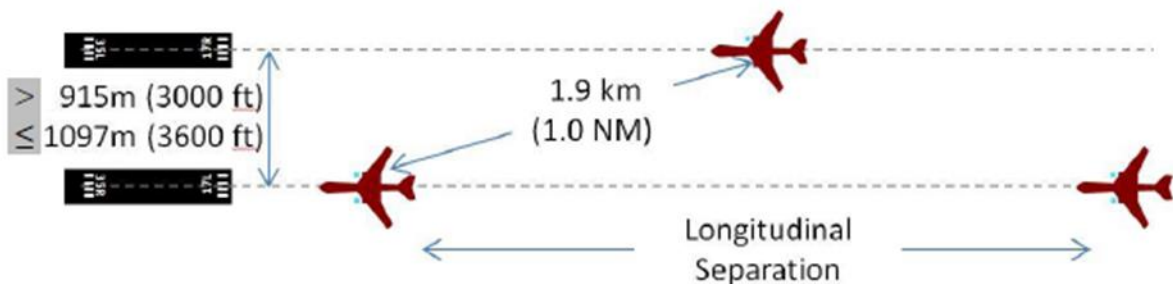

Figure 55: Diagonal separation for distance between centre lines greater than 915 m (3 000 ft) but less than or equal to 1 097 m (3 600 ft)

GM1 to AMC3 ATS.TR.255 Operations on parallel or near-parallel runways

ED Decision 2020/008/R

PRECISION APPROACH PROCEDURES

With reference to point (e)(1) of [AMC3 ATS.TR.255](#), the precision approach procedure that aligns the aircraft with the extended runway centre line may include one of the following: ILS, GLS, MLS or SBAS CAT I, when applicable, for the final approach segment.

GM2 to AMC3 ATS.TR.255 Operations on parallel or near-parallel runways

ED Decision 2020/008/R

ATIS BROADCAST

With reference to point (f) of [AMC3 ATS.TR.255](#), the information that dependent parallel operations are in force may be provided through the ATIS broadcasts.

AMC4 ATS.TR.255 Operations on parallel or near-parallel runways

ED Decision 2020/008/R

REQUIREMENTS AND PROCEDURES FOR SEGREGATED PARALLEL OPERATIONS

Segregated parallel operations should only be conducted on parallel runways when the following conditions are met:

- the runway centre lines are spaced by a minimum of 760 m (2 500 ft) (see Figure 56). Such minimum may be decreased by 30 m for each 150 m that the arrival runway is staggered toward the arriving aircraft, to a minimum of 300 m (see Figure 57), and should be increased by 30 m for each 150 m that the arrival runway is staggered away from the arriving aircraft (see Figure 58);
- the nominal departure track diverges immediately after take-off by at least 30 degrees from the missed approach track of the adjacent approach (see Figure 56);

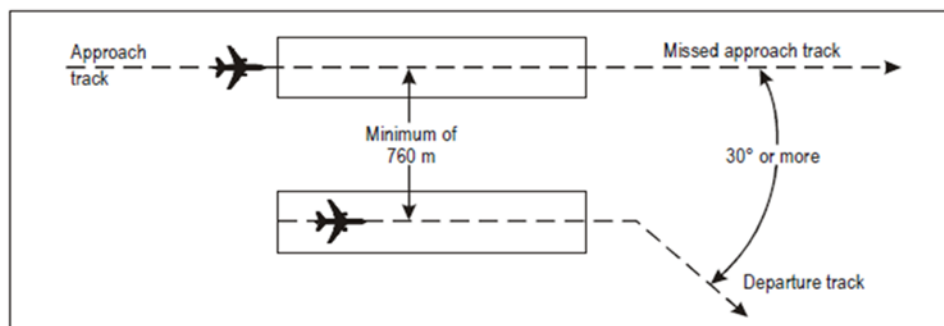
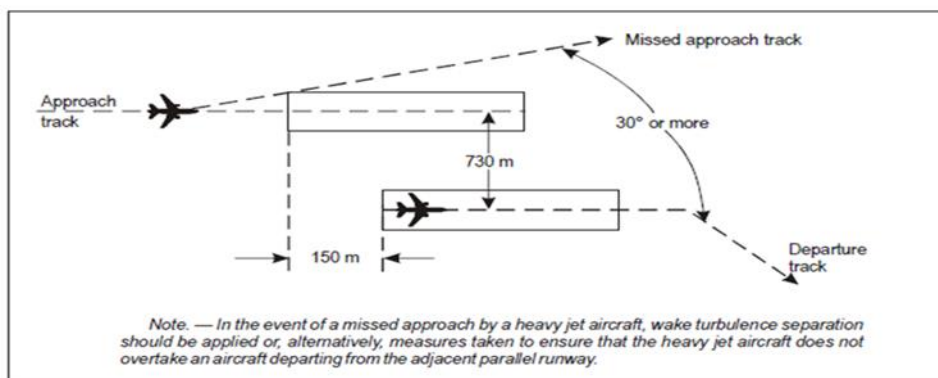
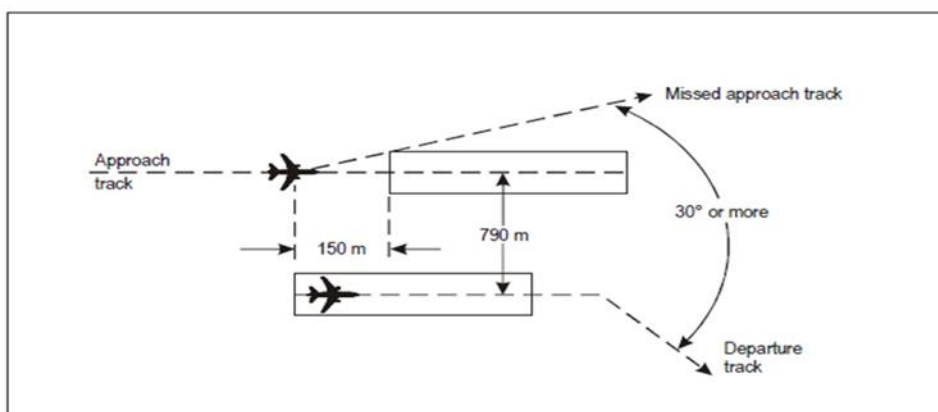

Figure 56: Segregated parallel operations

Figure 57: Segregated parallel operations where runways are staggered

Figure 58: Segregated parallel operations where runways are staggered

- (c) the instrument flight procedure that aligns the aircraft with the extended runway centre line is one of the following:
- (1) precision approaches and/or APV (RNP AR APCH, RNP APCH);
 - (2) surveillance radar approach (SRA);
 - (3) visual approach; and
- (d) a suitable ATS surveillance system and the appropriate ground facilities conform to the standard necessary for the specific type of approach in point (c) above.

GM1 to AMC2 ATS.TR.255; AMC3 ATS.TR.255 and AMC4 ATS.TR.255 Operations on parallel or near-parallel runways

ED Decision 2020/008/R

DETERMINATION THAT AN AIRCRAFT IS ESTABLISHED ON RNP AR APCH

- (a) An aircraft conducting an RNP AR APCH procedure (in accordance with Regulation (EU) 2018/1048) is considered to be established for the entire approach procedure after the IAF or the IF, as applicable, provided that:

- (1) the aircraft confirms that it is established on the RNP AR APCH procedure prior to a designated point, the location of which is to be determined by the competent authority;
- (2) the designated point is positioned on the RNP AR APCH to ensure the applicable horizontal separation minimum (e.g. 5.6 km (3 NM)) from the adjacent approach procedure (see Figure 59). The designated point may normally be coincident with the IAF; and

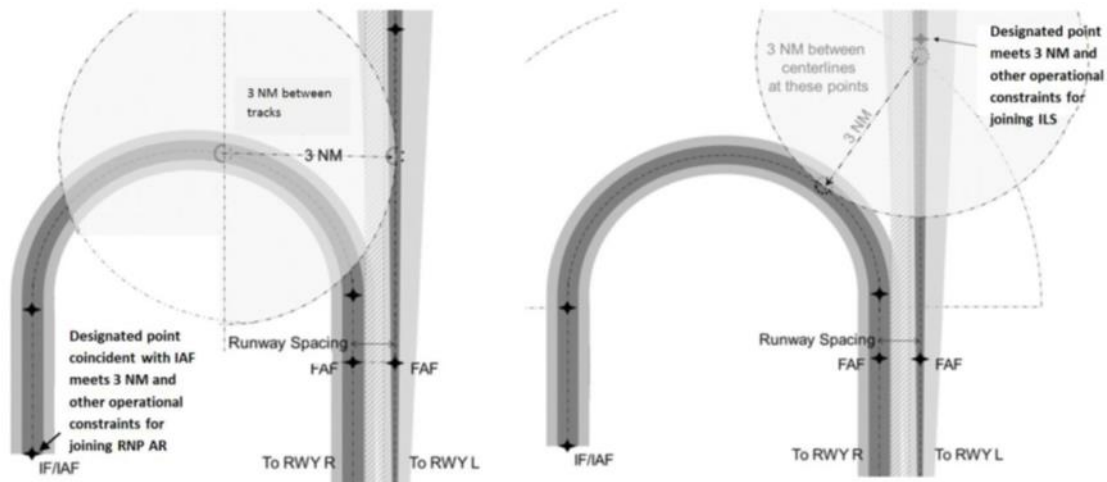

**Figure 59: Established on RNP AR APCH concept
(RNP AR APCH/precision approach with 3 NM separation minimum example)**

- (3) the designated point is readily apparent to the approach and monitoring air traffic controllers, to facilitate the application of the procedure. The designated point may be depicted on the situation display.
- (b) Attention is drawn to the application of the appropriate wake turbulence separation between aircraft on the same approach, as established in ATS.TR.220.
 - (c) If, after reporting that it is established on the RNP AR APCH procedure, the aircraft is unable to execute the procedure, the pilot is expected to notify the air traffic controller immediately with a proposed course of action, and thereafter follow ATC instructions (e.g. break-out procedure).
 - (d) In circumstances where a break-out procedure becomes necessary during the application of the independent parallel approach procedure (for example, an aircraft penetrating the NTZ), monitoring controllers may issue climb and/or heading instructions to an aircraft established on an RNP AR APCH. Guidance on break-out procedures is contained in ICAO Doc 9643 'Manual on Simultaneous Operations on Parallel or Near-Parallel Instrument Runways (SOIR)'.
 - (e) To support a break-out instruction, an obstacle assessment is to be completed, in accordance with Regulation (EU) 2017/373. Guidance on obstacle assessment is contained in ICAO Doc 9643 'Manual on Simultaneous Operations on Parallel or Near-Parallel Instrument Runways (SOIR)'.
 - (f) Where appropriate, break-out procedures are published in the AIP and in the local instructions.

GM1 ATS.TR.255 Operations on parallel or near-parallel runways

ED Decision 2020/008/R

Guidance material relating to operations on parallel or near-parallel runways is contained in ICAO Doc 9643 'Manual on Simultaneous Operations on Parallel or Near-Parallel Instrument Runways (SOIR)'.

ATS.TR.260 Selection of the runway-in-use

Commission Implementing Regulation (EU) 2020/469

The aerodrome control tower shall select the runway-in-use for take-off and landing of aircraft taking into consideration the surface wind speed and direction as well as other local relevant factors, such as:

- (a) runway configuration;
- (b) meteorological conditions;
- (c) instrument approach procedures;
- (d) approach and landing aids available;
- (e) aerodrome traffic circuits and air traffic conditions;
- (f) length of the runway or runways;
- (g) other factors indicated in local instructions.

AMC1 ATS.TR.260(g) Selection of the runway-in-use

ED Decision 2020/008/R

CONSIDERATION OF NOISE ABATEMENT IN THE SELECTION OF THE RUNWAY-IN-USE

- (a) The aerodrome control tower should select runways for noise abatement purposes for landing operations only when they are equipped with suitable glide path guidance, e.g. ILS, or a visual approach slope indicator system for operations in VMC.
- (b) Noise abatement should not be a determining factor in runway nomination under the following circumstances:
 - (1) if the runway surface conditions are adversely affected (e.g. by snow, slush, ice, water, mud, rubber, oil or other substances);
 - (2) for landing in conditions:
 - (i) when the ceiling is lower than 150 m (500 ft) above aerodrome elevation, or the visibility is less than 1 900 m; or
 - (ii) when the approach requires use of vertical minima greater than 100 m (300 ft) above aerodrome elevation and:
 - (A) the ceiling is lower than 240 m (800 ft) above aerodrome elevation; or
 - (B) the visibility is less than 3 000 m;
 - (3) for take-off when the visibility is less than 1 900 m;
 - (4) when wind shear has been reported or forecast or when thunderstorms are expected to affect the approach or departure; and

- (5) when the crosswind component, including gusts, exceeds 28 km/h (15 kt), or the tailwind component, including gusts, exceeds 9 km/h (5 kt).

GM1 ATS.TR.260 Selection of the runway-in-use

ED Decision 2020/008/R

- (a) Normally, an aircraft will land and take off into wind.
- (b) Departing aircraft may be expedited by suggesting a take-off direction which is not into the wind. It is the responsibility of the pilot-in-command of an aircraft to decide between making such a take-off or waiting for take-off in a preferred direction.

GM1 ATS.TR.260(e) Selection of the runway-in-use

ED Decision 2020/008/R

DESCRIPTION OF AIR TRAFFIC CONDITIONS

When considering the air traffic conditions for the selection of the runway-in-use, the following elements, inter alia, should be evaluated:

- (a) traffic complexity;
- (b) traffic density;
- (c) task complexity; and
- (d) traffic typology (e.g. prevalent aircraft types operating at the aerodrome and preferred runway-in-use).

ATS.TR.265 Control of aerodrome surface traffic in low-visibility conditions

Commission Implementing Regulation (EU) 2020/469

- (a) When there is a requirement for traffic to operate on the manoeuvring area in conditions of visibility which prevent the aerodrome control tower from applying visual separation between aircraft, and between aircraft and vehicles, the following shall apply:
- (1) at the intersection of taxiways, an aircraft or vehicle on a taxiway shall not be permitted to hold closer to the other taxiway than the holding position limit defined by intermediate holding positions, stop bar or taxiway intersection marking, in accordance with the applicable aerodrome design specifications;
- (2) the longitudinal separation method on taxiways shall be as specified for each particular aerodrome by the air traffic services provider and approved by the competent authority, taking into account the characteristics of the aids available for surveillance and control of ground traffic, the complexity of the aerodrome layout and the characteristics of the aircraft using the aerodrome.
- (b) Procedures applicable to the start and continuation of low-visibility operations shall be established in accordance with point ATS.OR.110 and shall be approved by the competent authority.

GM1 ATS.TR.265(a)(1) Control of aerodrome surface traffic in low-visibility conditions

ED Decision 2020/008/R

HOLDING POSITION LIMITS

The definition of holding position limits by intermediate holding positions, stop bar or taxiway intersection marking is established in accordance with EASA ED Decision 2014/013/R 'Certification Specification and Guidance Material for Aerodrome Design', as amended.

AMC1 ATS.TR.265(b) Control of aerodrome surface traffic in low-visibility conditions

ED Decision 2020/008/R

PROCEDURES FOR CONTROL OF AERODROME TRAFFIC IN LOW-VISIBILITY OPERATIONS (LVOs)

- (a) LVOs should be initiated by or through the aerodrome control tower.
- (b) The aerodrome control tower should inform the approach control unit concerned when procedures for precision approach in LVOs will be applied and also when such procedures are no longer in force.
- (c) Provisions regarding LVOs should specify:
 - (1) for the different types of LVOs, the RVR value(s) at which the LVOs procedures are to be implemented;
 - (2) the minimum navigation equipment requirements for LVOs;
 - (3) other facilities and aids required for LVOs, including aeronautical ground lights, which are to be monitored for normal operation;
 - (4) the criteria for and the circumstances under which downgrading of the navigation equipment from LVOs capability is to be made;
 - (5) the requirement to report any relevant equipment failure and degradation, without delay, to the flight crews concerned, the approach control unit, the aerodrome operator and, where established, the organisation(s) providing apron management services, and any other appropriate organisation;
 - (6) special procedures for the control of traffic on the manoeuvring area, including:
 - (i) the runway-holding positions to be used;
 - (ii) the minimum distance between an arriving and a departing aircraft to ensure protection of the sensitive and critical areas;
 - (iii) procedures to verify that aircraft and vehicles have vacated the runway; and
 - (iv) procedures applicable to the separation of aircraft and vehicles;
 - (7) the applicable spacing between successive approaching aircraft;
 - (8) the action(s) to be taken in the event that LVOs need to be discontinued, e.g. due to equipment failures; and
 - (9) any other relevant procedures or requirements.

- (d) The aerodrome control tower should, prior to a period of application of low-visibility procedures, establish a record of vehicles and persons currently on the manoeuvring area and maintain this record during the period of application of these procedures to assist in assuring the safety of operations on that area.

ATS.TR.270 Authorisation of special VFR

Commission Implementing Regulation (EU) 2020/469

- (a) Special VFR flights may be authorised to operate within a control zone, subject to an ATC clearance. Except when permitted by the competent authority for helicopters in special cases such as but not limited to police, medical, search and rescue operations and firefighting flights, the following additional conditions shall be applied:
- (1) such special VFR flights may be conducted during day only, unless otherwise permitted by the competent authority;
 - (2) by the pilot:
 - (i) clear of cloud and with the surface in sight;
 - (ii) the flight visibility is not less than 1 500 m or, for helicopters, not less than 800 m;
 - (iii) fly at a speed of 140 kt IAS or less to give adequate opportunity to observe other traffic and any obstacles in time to avoid a collision;
 - (3) An air traffic control unit shall not issue a special VFR clearance to aircraft to take off or land at an aerodrome within a control zone, or enter the aerodrome traffic zone or aerodrome traffic circuit when the reported meteorological conditions at that aerodrome are below the following minima:
 - (i) the ground visibility is less than 1 500 m or, for helicopters, less than 800 m;
 - (ii) the ceiling is less than 180 m (600 ft).
- (b) An air traffic control unit shall handle requests for such an authorisation individually.

GM1 ATS.TR.270 Authorisation of special VFR

ED Decision 2020/008/R

SPECIAL VFR — DEVIATIONS

The list of type of operations subject to permit by the competent authority to deviate from the requirements for special VFR flights is not exhaustive. The competent authority may grant a permit for other kinds of helicopter operations such as power line inspections, helicopter hoist operations, etc.

GM1 ATS.TR.270(a)(3) Authorisation of special VFR

ED Decision 2020/008/R

SPECIAL VFR IN CONTROL ZONES

When the reported ground visibility at the aerodrome is less than 1 500 m, air traffic control units may issue a special VFR clearance for a flight crossing the control zone and not intending to take off or land at an aerodrome within a control zone, or enter the aerodrome traffic zone or aerodrome traffic circuit

when the flight visibility reported by the pilot is not less than 1 500 m, or, for helicopters, not less than 800 m.

SECTION 3 - FLIGHT INFORMATION SERVICE

ATS.TR.300 Application

Commission Implementing Regulation (EU) 2020/469

- (a) Flight information service shall be provided by the appropriate air traffic services units to all aircraft which are likely to be affected by the information and which are in either of the following situations:
 - (1) provided with air traffic control service;
 - (2) otherwise known to the relevant air traffic services units.
- (b) Where air traffic services units provide both flight information service and air traffic control service, the provision of air traffic control service shall have precedence over the provision of flight information service whenever the provision of air traffic control service so requires.
- (c) A flight information service provider shall establish arrangements for:
 - (1) recording and transmission of information on the progress of flights;
 - (2) coordination and transfer of responsibility for the provision of flight information service.

GM1 ATS.TR.300(a)(2) Application

ED Decision 2020/008/R

PROVISION OF FLIGHT INFORMATION SERVICE TO AIRCRAFT OTHERWISE KNOWN TO AIR TRAFFIC SERVICES

In the context of flight information service, the expression 'otherwise known to the relevant air traffic service unit' transposed from the Standard in Section 4.1 of ICAO Annex 11, covers the cases when the aircraft is operating within uncontrolled airspace, where there are no requirements for the submission of a flight plan or for a continuous air-ground two-way communication with the air traffic services unit in charge of providing services in that portion of airspace. Therefore, the expression may be interpreted as traffic, the current flight details and intentions of which are known to the air traffic controllers/FIS officer/AFIS officer.

GM1 ATS.TR.300(b) Application

ED Decision 2020/008/R

It is recognised that in certain circumstances an aircraft on final approach, landing, take-off and climb may require to receive without delay essential information other than that pertaining to the air traffic control service provision.

AMC1 ATS.TR.300(c)(1) Application

ED Decision 2020/008/R

RECORDING AND TRANSMISSION OF INFORMATION ON THE PROGRESS OF FLIGHTS

Information on the actual progress of flights, including those of heavy or medium unmanned free balloons, under neither air traffic control service nor air traffic advisory service should be:

- (a) recorded by the air traffic services unit serving the FIR within which the aircraft is flying in such a manner that it is available for reference and in case it is requested for alerting service and search and rescue action; and
- (b) transmitted by the air traffic services unit receiving the information to other air traffic services units concerned, when so required for the purposes of the coordination between air traffic services units providing flight information service in adjacent FIRs in respect of IFR and VFR flights (see points (a) and (b) of [GM2 ATS.TR.300\(c\)\(2\)](#)).

GM1 to AMC1 ATS.TR.300(c)(1) Application

ED Decision 2020/008/R

RECORDING AND TRANSMISSION OF INFORMATION ON THE PROGRESS OF FLIGHTS

- (a) Information on the progress of flights, including flight plan data, may be recorded through the use of paper flight progress strips or electronic flight progress strips, by other electronic presentation forms or by a combination of presentation methods.
- (b) The air traffic services provider should specify the procedures for annotating data and provisions specifying the types of data to be entered on flight progress strips, including the use of symbols.

GM1 ATS.TR.300(c)(2) Application

ED Decision 2020/008/R

INFORMATION EXCHANGE IN CASE OF TERMINATION OF A CONTROLLED FLIGHT

In the case where a flight ceases to be operated as a controlled flight, i.e. by leaving controlled airspace or by cancelling its IFR flight and proceeding on VFR in airspace where VFR flights are not controlled, the air traffic control unit concerned should ensure that appropriate information on the flight is forwarded to air traffic services unit(s) responsible for the provision of flight information and alerting services for the remaining portion of the flight, in order to ensure that such services will be provided to the aircraft.

GM2 ATS.TR.300(c)(2) Application

ED Decision 2020/008/R

COORDINATION IN RESPECT OF THE PROVISION OF FLIGHT INFORMATION SERVICE AND ALERTING SERVICE

- (a) Coordination between air traffic services units providing flight information service in adjacent FIRs should be effected in respect of IFR and VFR flights, in order to ensure continued flight information service to such aircraft in specified areas or along specified routes. Such coordination should be effected in accordance with an agreement between the air traffic services units concerned.
- (b) The coordination of flights effected in accordance with point (a) should include transmission of the following information on the flight concerned:
 - (1) appropriate items of the current flight plan; and
 - (2) the time at which last contact was made with the aircraft concerned.
- (c) This information should be forwarded to the air traffic services unit in charge of the next FIR in which the aircraft will operate prior to the aircraft entering such FIR.

- (d) In order to assist in the identification of strayed or unidentified aircraft and thereby eliminate or reduce the need for interception, flight plan and flight progress information for flights along specified routes or portions of routes in close proximity to FIR boundaries should also be provided to the air traffic services units in charge of the FIRs adjacent to such routes or portions of routes.
- (e) In circumstances where an aircraft has declared minimum fuel or is experiencing an emergency or in any other situation wherein the safety of the aircraft is not assured, the type of emergency and/or the circumstances experienced by the aircraft should be reported by the transferring unit to the accepting control unit and any other air traffic services unit that may be concerned with the flight and to the associated rescue coordination centres, if necessary.

ATS.TR.305 Scope of flight information service

Commission Implementing Regulation (EU) 2020/469

- (a) Flight information service shall include the provision of pertinent:
 - (1) SIGMET and AIRMET information;
 - (2) information concerning pre-eruption volcanic activity, volcanic eruptions and volcanic ash clouds;
 - (3) information concerning the release into the atmosphere of radioactive materials or toxic chemicals;
 - (4) information on changes in the availability of radio navigation services;
 - (5) information on changes in the condition of aerodromes and associated facilities, including information on the state of the aerodrome movement areas when they are affected by snow, ice or significant depth of water;
 - (6) information on unmanned free balloons;
 - (7) information on abnormal aircraft configuration and condition;
 - (8) any other information likely to affect safety.
- (b) Flight information service provided to flights shall include, in addition to that outlined in point (a), the provision of information concerning:
 - (1) weather conditions reported or forecast at departure, destination and alternate aerodromes;
 - (2) collision hazards, to aircraft operating in airspace Classes C, D, E, F and G;
 - (3) for flight over water areas, in so far as practicable and when requested by a pilot, any available information such as radio call sign, position, true track, speed, etc. of surface vessels in the area;
 - (4) messages, including clearances, received from other air traffic services units to relay to aircraft.
- (c) AFIS provided to flights shall include, in addition to relevant items outlined in points (a) and (b), the provision of information concerning:
 - (1) collision hazards with aircraft, vehicles and persons operating on the manoeuvring area;
 - (2) the runway-in-use.

- (d) Air traffic services units shall transmit, as soon as practicable, special and non-routine air-reports to:
- (1) other aircraft concerned;
 - (2) the associated meteorological watch office in accordance with Appendix 5 to Implementing Regulation (EU) No 923/2012;
 - (3) other air traffic services units concerned.
- Transmissions to aircraft shall be repeated at a frequency and continued for a period of time which shall be determined by the air traffic services unit concerned.
- (e) Flight information service provided to VFR flights shall include, in addition to that outlined in point (a), the provision of available information concerning traffic and weather conditions along the route of flight that are likely to make operation under the visual flight rules impracticable.
- (f) When so prescribed by the competent authority, the AFIS unit shall manage the movement of vehicles and persons on the manoeuvring area in accordance with the set or subset of provisions in point [ATS.TR.240](#).

AMC1 ATS.TR.305 Scope of flight information service

ED Decision 2020/017/R

TRANSMISSION OF INFORMATION

- (a) Means of transmission
- (1) Information should be disseminated to aircraft by one or more of the following means:
 - (i) the preferred method of directed transmission on the initiative of the appropriate air traffic services unit to an aircraft, ensuring that receipt is acknowledged; or
 - (ii) general call, unacknowledged transmission to all aircraft concerned; or
 - (iii) broadcast; or
 - (iv) data link.
 - (2) The use of general calls should be limited to cases where it is necessary to disseminate essential information to several aircraft without delay, e.g. the sudden occurrence of hazards, a change of the runway-in-use, or the failure of a key approach and landing aid.
- (b) Transmission of special air-reports, SIGMET and AIRMET information
- (1) Appropriate SIGMET and AIRMET information, as well as special air-reports which have not been used for the preparation of a SIGMET, should be disseminated to aircraft by one or more of the means specified in point (a) as established by the competent authority. Special air-reports should be transmitted with the least possible delay and disseminated to aircraft for a period of 60 minutes after their issuance.
 - (2) The special air-report, SIGMET and AIRMET information to be passed on to aircraft on ground initiative should cover a portion of the route up to 1 hour's flying time ahead of the aircraft.

- (c) Transmission of information concerning volcanic activity
- Information concerning pre-eruption volcanic activity, volcanic eruptions and volcanic ash clouds (position of clouds and flight levels affected) should be disseminated to aircraft by one or more of the means specified in point (a) as established by the competent authority.
- (d) Transmission of information concerning radioactive materials and toxic chemical clouds
- Information on the release into the atmosphere of radioactive materials or toxic chemicals which could affect airspace within the area of responsibility of the air traffic services unit should be transmitted to aircraft by one or more of the means specified in point (a).
- (e) Transmission of local special reports, SPECI and amended TAF
- (1) Special reports and amended TAF should be transmitted on request and supplemented by:
- (i) directed transmission from the appropriate air traffic services unit of selected special reports and amended TAF for the departure, destination and its alternate aerodromes, as listed in the flight plan; or
 - (ii) a general call on appropriate frequencies for the unacknowledged transmission to affected aircraft of selected special reports and amended TAF; or
 - (iii) continuous or frequent broadcast or the use of data link to make available current METAR and TAF in areas determined on the basis of regional air navigation agreements where traffic congestion dictates. VOLMET broadcasts and/or D-VOLMET should be used to serve this purpose.
- (2) The passing of amended aerodrome forecasts to aircraft on the initiative of the appropriate air traffic services unit should be limited to that portion of the flight where the aircraft is within a specified time from the aerodrome of destination, such time being established on the basis of regional air navigation agreements.
- (3) SPECI should, when issued for aerodromes not serving scheduled commercial air transport, be transmitted on request.
- (f) Transmission of information on heavy or medium unmanned free balloons
- Appropriate information on heavy or medium unmanned free balloons should be disseminated to aircraft by one or more of the means specified in point (a).
- (g) Transmission of information to supersonic aircraft
- The following information should be available at appropriate ACCs or flight information centres for aerodromes determined by the competent authority and should be transmitted on request to supersonic aircraft prior to commencement of deceleration/descent from supersonic cruise:
- (1) current meteorological reports and forecasts, except that where communications difficulties are encountered under conditions of poor propagation, the elements transmitted may be limited to:
- (i) mean surface wind, direction and speed (including gusts);
 - (ii) visibility or RVR;
 - (iii) amount and height of base of low clouds;
 - (iv) other significant information; and

- (v) if appropriate, information regarding expected changes;
- (2) operationally significant information on the status of facilities relating to the runway-in-use, including the precision approach category in the event that the lowest approach category promulgated for the runway is not available; and
- (3) sufficient information on the runway surface conditions to permit assessment of the runway braking action.

GM1 ATS.TR.305 Scope of flight information service

ED Decision 2020/017/R

PRESENTATION OF INFORMATION FOR THE PROVISION OF FLIGHT INFORMATION SERVICE

- (a) The air traffic services provider should consider the manner in which data and information are provided to the FIS officer/AFIS officer, paying particular attention, where applicable, to the method of representing the air traffic situation to the FIS officer/AFIS officer and taking into account human performance. Additional guidance on human performance may be found in ICAO Doc 9683 'Human Factors Training Manual'.
- (b) All information and data, including data related to individual aircraft, should be presented in a manner which minimises the potential for misinterpretation or misunderstanding.
- (c) Where used, data generated automatically should be presented to the FIS officer/AFIS officer in a timely manner. The presentation of information and data for individual flights should continue until such time as the data is no longer required for the purpose of providing flight information service, or until terminated by the FIS officer/AFIS officer.
- (d) Information displays may be generated and updated automatically, or the data may be entered and updated by authorised personnel.

AMC1 ATS.TR.305(a);(b) Scope of flight information service

ED Decision 2020/008/R

INFORMATION FOR DEPARTING AIRCRAFT — METEOROLOGICAL CONDITIONS

Information regarding significant changes in the meteorological conditions in the take-off or climb-out area, obtained by the unit providing approach control service after a departing aircraft has established communication with such unit, should be transmitted to the aircraft without delay, except when it is known that the aircraft already has received the information.

GM1 to AMC1 ATS.TR.305(a);(b) Scope of flight information service

ED Decision 2020/008/R

INFORMATION FOR DEPARTING AIRCRAFT — METEOROLOGICAL CONDITIONS

Significant changes in this context include those relating to surface wind direction or speed, visibility, RVR or air temperature (for turbine-engined aircraft), and the occurrence of thunderstorm or cumulonimbus, moderate or severe turbulence, wind shear, hail, moderate or severe icing, severe squall line, freezing precipitation, severe mountain waves, sandstorm, dust storm, blowing snow, tornado or waterspout.

GM1 ATS.TR.305(a);(b);(c) Scope of flight information service

ED Decision 2020/008/R

INFORMATION TO AIRCRAFT BY AFIS UNITS — AERODROME AND METEOROLOGICAL INFORMATION

- (a) Prior to taxiing for take-off, the AFIS unit should advise aircraft of the following elements of information, in the order listed, with the exception of such elements which are known to have been already received by the aircraft:
- (1) the runway-in-use;
 - (2) the surface wind direction and speed, including significant variations therefrom;
 - (3) the QNH altimeter setting and, either on a regular basis in accordance with local arrangements or if so requested by the aircraft, the QFE altimeter setting;
 - (4) the air temperature for the runway-in-use, in the case of turbine-engined aircraft;
 - (5) the visibility representative of the direction of take-off and initial climb, if less than 10 km, or, when applicable, the RVR value(s) for the runway-in-use; and
 - (6) the correct time.
- (b) Prior to take-off, the AFIS unit should advise aircraft of:
- (1) any significant changes in the surface wind direction and speed, the air temperature, and the visibility or RVR value(s) given in accordance with point (a); and
 - (2) significant meteorological conditions in the take-off and climb-out area, except when it is known that the information has already been received by the aircraft. ‘Significant meteorological conditions’ in this context include the occurrence or expected occurrence of cumulonimbus or thunderstorm, moderate or severe turbulence, wind shear, hail, moderate or severe icing, severe squall line, freezing precipitation, severe mountain waves, sandstorm, dust storm, blowing snow, tornado or waterspout in the take-off and climb-out area.

GM2 ATS.TR.305(a);(b);(c) Scope of flight information service

ED Decision 2020/008/R

INFORMATION TO AIRCRAFT BY AFIS UNITS — INFORMATION FOR ARRIVING AIRCRAFT

- (a) Prior to entering the traffic circuit or commencing its approach to land, the AFIS unit should provide aircraft with the following elements of information, in the order listed, with the exception of such elements which are known to have been already received by the aircraft:
- (1) the runway-in-use;
 - (2) the surface wind direction and speed, including significant variations therefrom; and
 - (3) the QNH altimeter setting and, either on a regular basis in accordance with local arrangements or if so requested by the aircraft, the QFE altimeter setting.
- (b) For arriving IFR traffic that intends to conduct an instrument approach, the AFIS unit should, as early as practicable after an aircraft has established communication with the unit, transmit to the aircraft the following elements of information, in the order listed, with the exception of such elements which are known to have been already received by the aircraft :
- (1) Runway-in-use; and

-
- (2) Meteorological information, as follows:
- (i) surface wind direction and speed, including significant variations therein;
 - (ii) visibility and, when applicable, RVR;
 - (iii) present weather;
 - (iv) cloud below 1 500 m (5 000 ft) or below the highest minimum sector altitude, whichever is greater; cumulonimbus; if the sky is obscured, vertical visibility when available;
 - (v) air temperature;
 - (vi) dew point temperature, inclusion determined on the basis of a regional air navigation agreement;
 - (vii) altimeter setting(s);
 - (viii) any available information on significant meteorological phenomena in the approach area; and
 - (ix) trend-type landing forecast, when available.
- (c) For arriving IFR traffic conducting an instrument approach, at the commencement of final approach the AFIS unit should transmit the following information to the aircraft:
- (1) significant variations in the mean surface wind direction and speed. ‘Significant variations’ are specified in point (a)(3) of MET.TR.205. However, if the AFIS unit transmits wind information in the form of components, the significant changes are:
 - (i) mean headwind component: 19 km/h (10 kt);
 - (ii) mean tailwind component: 4 km/h (2 kt); and
 - (iii) mean crosswind component: 9 km/h (5 kt);
 - (2) the latest information, if any, on wind shear and/or turbulence in the final approach area; and
 - (3) the current visibility representative of the direction of approach and landing or, when provided, the current RVR value(s) and the trend.
- (d) For arriving IFR traffic conducting an instrument approach, during the final approach the AFIS unit should transmit without delay the following information to the aircraft:
- (1) the sudden occurrence of hazards (e.g. unauthorised traffic on the runway);
 - (2) significant variations in the current surface wind, expressed in terms of minimum and maximum values;
 - (3) significant changes in runway surface conditions;
 - (4) changes in the operational status of required visual or non-visual aids;
 - (5) changes in observed RVR value(s), in accordance with the reported scale in use, or changes in the visibility representative of the direction of approach and landing.

GM3 ATS.TR.305(a);(b);(c) Scope of flight information service

ED Decision 2020/008/R

TRAFFIC INFORMATION TO AIRCRAFT IN THE AFIS CONTEXT

The AFIS unit should provide the following information, as appropriate:

- (a) direction of flight of aircraft concerned;
- (b) type and wake turbulence category (if known) of aircraft concerned;
- (c) level of aircraft concerned, including possible changes;
- (d) relative bearing of the aircraft concerned in terms of the 12-hour clock as well as distance from the conflicting traffic; or
 - (1) actual or estimated position of the aircraft concerned; or
 - (2) estimated times; and
- (e) any other information considered relevant (e.g. approaching, crossing the flight information zone, estimated take-off or landing time).

GM4 ATS.TR.305(a);(b);(c) Scope of flight information service

ED Decision 2020/008/R

LOCAL TRAFFIC INFORMATION TO AIRCRAFT IN THE AFIS CONTEXT

AFIS units should issue traffic information on local traffic in a timely manner, either directly or through the unit providing approach control service when, in the judgement of the AFIS unit, such information is necessary in the interest of safety, or when requested by aircraft. Local traffic should be described so as to be easily identified by the pilot.

GM5 ATS.TR.305(a);(b);(c) Scope of flight information service

ED Decision 2020/008/R

WAKE TURBULENCE AND JET BLAST HAZARDS INFORMATION TO AIRCRAFT IN THE AFIS CONTEXT

- (a) The responsibility for wake turbulence avoidance rests entirely with the pilot-in-command. AFIS units should, to the extent practicable, advise aircraft of the expected occurrence of hazards caused by turbulent wake. Such information will be provided by the warning 'caution wake turbulence' and may also include relevant information on the aircraft concerned.
- (b) In providing information, AFIS units should take into account the hazards caused by jet blast, helicopter downwash turbulence and propeller slipstream to taxiing aircraft, to aircraft taking off or landing, particularly when intersecting runways are being used, and to vehicles and personnel operating on the aerodrome.

AMC1 ATS.TR.305(a)(5) Scope of flight information service

ED Decision 2020/008/R

ESSENTIAL INFORMATION ON AERODROME CONDITIONS

Essential information on aerodrome conditions should be given to every aircraft, except when it is known that the aircraft has already received all or part of the information from other sources, including NOTAM(s), ATIS broadcasts, and the display of suitable signals. The information should be

given in sufficient time for the aircraft to make proper use of it, and the hazards should be identified as distinctly as possible.

GM1 to AMC1 ATS.TR.305(a)(5) Scope of flight information service

ED Decision 2020/008/R

ESSENTIAL INFORMATION ON AERODROME CONDITIONS

- (a) Essential information on aerodrome conditions is information necessary to safety in the operation of aircraft, which pertains to the movement area or any facilities usually associated therewith. For example, construction work on a taxi strip not connected to the runway-in-use would not be essential information to any aircraft except one that might be taxied in the vicinity of the construction work. As another example, if all traffic must be confined to runways, that fact should be considered as essential aerodrome information to any aircraft not familiar with the aerodrome.
- (b) Essential information on aerodrome conditions should include information relating to the following:
 - (1) construction or maintenance work on, or immediately adjacent to, the movement area;
 - (2) rough or broken surfaces on a runway, a taxiway or an apron, whether marked or not;
 - (3) water, snow, slush, ice or frost on a runway, a taxiway or an apron;
 - (4) anti-icing or de-icing liquid chemicals or other contaminants on a runway, taxiway or apron;
 - (5) other temporary hazards, including parked aircraft and birds on the ground or in the air;
 - (6) failure or irregular operation of part or all of the aerodrome lighting system; and
 - (7) any other pertinent information.
- (c) Up-to-date information on the conditions on aprons may not always be available to the aerodrome control tower or to the AFIS unit. The responsibility of the aerodrome control tower or the AFIS unit in relation to aprons is, with respect to the provision of information as described in points (a) and (b), limited to the transmission to aircraft of the information which is provided to it by the operator responsible for the aprons.

AMC2 ATS.TR.305(a)(5) Scope of flight information service

ED Decision 2020/008/R

INFORMATION FOR DEPARTING AIRCRAFT — OPERATIONAL STATUS OF VISUAL AND NON-VISUAL AIDS

Information regarding changes in the operational status of visual or non-visual aids essential for take-off and climb should be transmitted without delay to a departing aircraft, except when it is known that the aircraft has already received the information.

GM1 ATS.TR.305(a)(6) Scope of flight information service

ED Decision 2020/008/R

INFORMATION ON UNMANNED FREE BALLOONS

- (a) On receipt of notification of the intended flight of a medium or heavy unmanned free balloon, the air traffic services unit should arrange for the information to be disseminated to all concerned. The information should include:
- (1) the balloon flight identification or project code name;
 - (2) balloon classification and description;
 - (3) SSR code or NDB frequency as applicable;
 - (4) the launch site;
 - (5) the estimated time of the commencement of the launch or the planned period of the launches;
 - (6) the expected direction of ascent;
 - (7) the cruising level(s) (pressure-altitude); and
 - (8) the estimated elapsed time to pass 18 000 m (60 000 ft) pressure-altitude, or to reach cruising level if at or below 18 000 m (60 000 ft), together with the estimated location.
- (b) On receipt of notification that a medium or heavy unmanned free balloon has been launched, the air traffic services unit should arrange for the information to be disseminated to all concerned. The information should include:
- (1) the balloon flight identification or project code name;
 - (2) balloon classification and description;
 - (3) SSR code or NDB frequency as applicable;
 - (4) the launch site;
 - (5) the time of launch(-es);
 - (6) the estimated time at which 18 000 m (60 000 ft) pressure-altitude will be passed, or the estimated time at which the cruising level will be reached if at or below 18 000 m (60 000 ft), and the estimated location;
 - (7) the estimated date and time of termination of the flight; and
 - (8) the planned location of ground contact, when applicable.
- (c) When there is reasonable expectation that a heavy or medium unmanned free balloon will cross international borders, the appropriate air traffic services unit should arrange for the pre-launch and the launch notifications to be sent by NOTAM to the air traffic services unit(s) in the State(s) concerned. If agreed between the States concerned, the launch notification may be transmitted orally by direct ATS speech circuit between the ACCs/flight information centres involved.

AMC1 ATS.TR.305(a)(7) Scope of flight information service

ED Decision 2020/008/R

INFORMATION ON ABNORMAL AIRCRAFT CONFIGURATION AND CONDITION

- (a) Whenever an abnormal configuration or condition of an aircraft, including conditions such as landing gear not extended or only partly extended, or unusual smoke emissions from any part of the aircraft, is observed by or reported to the aerodrome air traffic controller or the AFIS officer, the aircraft concerned should be advised without delay.
- (b) When requested by the flight crew of a departing aircraft suspecting damage to the aircraft, the departure runway used should be inspected without delay and the flight crew advised in the most expeditious manner as to whether any aircraft debris or bird or animal remains have been found or not.

GM1 ATS.TR.305(a)(8) Scope of flight information service

ED Decision 2020/008/R

INFORMATION ON AIRSPACE RESERVATIONS AND RESTRICTIONS

Flight information service should include the provision of relevant information on airspace restrictions and/or reservations, as also stipulated in Regulation (EC) No 2150/2005.

GM2 ATS.TR.305(a)(8) Scope of flight information service

ED Decision 2020/008/R

INFORMATION ON SPACE WEATHER

When available, information on space weather phenomena that have an impact on high-frequency radio communications, communications via satellite, GNSS-based navigation and surveillance systems, and/or pose a radiation risk to aircraft occupants at flight levels, within the area of responsibility of the air traffic services unit should be transmitted to the affected aircraft.

GM1 ATS.TR.305(b)(1) Scope of flight information service

ED Decision 2020/008/R

INFORMATION RELATED TO WEATHER CONDITIONS AT DEPARTURE, DESTINATION, AND ALTERNATE AERODROMES

Pilots normally obtain information on the weather conditions from the appropriate office before the flight. Outstanding or safety-relevant information is normally provided by radio communication when available.

GM1 ATS.TR.305(b)(2) and (c)(1) Scope of flight information service

ED Decision 2020/008/R

INFORMATION CONCERNING COLLISION HAZARDS

Information relating to collision hazards includes only known activities that constitute risks to the aircraft concerned. The availability of such information to air traffic services may sometimes be incomplete (e.g. limitations in radar or radio coverage, optional radio contact by pilots, limitations in the accuracy of reported information by pilots, or unconfirmed level of information) and, therefore, air traffic services cannot assume responsibility for its issuance at all times or for its accuracy.

GM2 ATS.TR.305(b)(2) Scope of flight information service

ED Decision 2020/008/R

ATS SURVEILLANCE SERVICE — INFORMATION REGARDING TRAFFIC ON CONFLICTING PATH

When an identified IFR flight operating outside controlled airspace is observed to be on a conflicting path with another aircraft, the pilot should, as far as practicable:

- (a) be informed as to the need for collision avoidance action to be initiated, and if so requested by the pilot or if, in the opinion of the air traffic controller, the FIS officer or the AFIS officer, the situation warrants, a course of avoiding action should be suggested; and
- (b) be notified when the conflict no longer exists.

GM1 ATS.TR.305(b)(4) Scope of flight information service

ED Decision 2020/008/R

INFORMATION TO AIRCRAFT BY AFIS UNITS — START-UP TIME PROCEDURES

- (a) Start-up time procedures should be implemented where necessary to avoid congestion and excessive delays on the manoeuvring area or when warranted by ATFM regulations. Start-up time procedures should be contained in local instructions, and should specify the criteria and conditions for determining when and how start-up times shall be calculated and issued to departing flights.
- (b) When an aircraft is subject to ATFM regulations, it should be advised to start up in accordance with its allocated slot time.

GM1 ATS.TR.305(c)(1) Scope of flight information service

ED Decision 2020/008/R

RUNWAY INCURSION OR OBSTRUCTED RUNWAY

In the event that the AFIS officer becomes aware of a runway incursion or the imminent occurrence thereof, or the existence of any obstruction on or in close proximity to the runway likely to impair the safety of an aircraft taking off or landing, appropriate action should be taken to inform the aircraft of the runway incursion or obstruction and its location in relation to the runway.

GM2 ATS.TR.305(c)(1) Scope of flight information service

ED Decision 2020/008/R

AFIS officers should maintain a continuous watch on all flight operations on and in the vicinity of an aerodrome as well as on vehicles and personnel on the manoeuvring area in order to fulfil the task described in point (c)(1) of [ATS.TR.305](#).

GM1 ATS.TR.305(c)(2) Scope of flight information service

ED Decision 2020/008/R

RUNWAY-IN-USE AT AFIS AERODROMES

- (a) Normally, an aircraft will land and take off into wind unless safety or other local factors determine that a different direction is preferable.

- (b) In considering the most suitable runway-in-use for take-off and landing of aircraft, besides surface wind speed and direction, other relevant factors should be taken into consideration such as:
- (1) runway configuration;
 - (2) meteorological conditions;
 - (3) instrument approach procedures;
 - (4) approach and landing aids available;
 - (5) aerodrome traffic circuits;
 - (6) airspace considerations;
 - (7) length of runways; and
 - (8) other factors indicated in local instructions.
- (c) When AFIS officers provide information concerning the runway-in-use, it should be interpreted as a suggestion to the pilot on which would be the most suitable runway for take-off and landing, based on the information available. The decision on the selection and use of the runway is a responsibility of the pilot-in-command. A pilot-in-command can refuse a runway-in-use suggested by an AFIS officer. In such circumstances, AFIS officers should provide detailed information on other aerodrome traffic that is utilising the runway-in-use to assist the pilot in fulfilling their responsibilities under SERA.3205 of Regulation (EU) No 923/2012 when using an alternative runway.

GM1 ATS.TR.305(d)(3) Scope of flight information service

ED Decision 2020/008/R

OTHER AIR TRAFFIC SERVICES UNITS CONCERNED

‘Other air traffic services units concerned’ are those that have flights under their jurisdiction which are expected to enter the airspace concerned at a later stage of flight. Those flights could, for instance, require rerouting before entering the airspace concerned. As an example, a special air-report concerning volcanic ash or volcanic eruption could be necessary to be transmitted to aircraft by air traffic services units in the FIR adjacent to that affected by that air-report.

ATS.TR.310 Voice-automatic terminal information service (Voice-ATIS) broadcasts

Commission Implementing Regulation (EU) 2020/469

- (a) Voice-automatic terminal information service (Voice-ATIS) broadcasts shall be provided at aerodromes where there is a requirement to reduce the communication load on the air traffic services VHF air-ground communication channels. When provided, they shall comprise either of the following:
- (1) one broadcast serving arriving aircraft;
 - (2) one broadcast serving departing aircraft;
 - (3) one broadcast serving both arriving and departing aircraft;

- (4) two broadcasts serving arriving and departing aircraft respectively at those aerodromes where the length of a broadcast serving both arriving and departing aircraft would be excessively long.
- (b) A discrete VHF frequency shall, whenever practicable, be used for Voice-ATIS broadcasts. If a discrete frequency is not available, the transmission may be made on the voice channel or channels of the most appropriate terminal navigation aid or aids, preferably a VOR, provided the range and readability are adequate and the identification of the navigation aid is sequenced with the broadcast so that the latter is not obliterated.
- (c) Voice-ATIS broadcasts shall not be transmitted on the voice channel of an ILS.
- (d) Whenever Voice-ATIS is provided, the broadcast shall be continuous and repetitive.
- (e) The information contained in the current broadcast shall immediately be made known to the air traffic services unit or units concerned with the provision to aircraft of information relating to approach, landing and take-off, whenever the message has not been prepared by that unit or those units.
- (f) Voice-ATIS broadcasts provided at designated aerodromes for use by international air services shall be available in the English language as a minimum

GM1 ATS.TR.310 Voice-automatic terminal information service (Voice-ATIS) broadcasts

ED Decision 2020/008/R

ATIS BROADCAST MESSAGES

The Voice-ATIS broadcast message should, whenever practicable, not exceed 30 seconds, care being taken that the readability of the ATIS message is not impaired by the speed of the transmission or by the identification signal of a navigation aid used for transmission of ATIS. The ATIS broadcast message should take into consideration human performance. Additional guidance on human performance may be found in ICAO Doc 9683 'Human Factors Training Manual'

GM1 ATS.TR.310(f) Voice-automatic terminal information service (Voice-ATIS) broadcasts

ED Decision 2020/008/R

ATIS BROADCAST CHANNELS

Where Voice-ATIS broadcasts are available in more than one language, a discrete channel should be used for each language.

ATS.TR.315 Data link-automatic terminal information service (D-ATIS)

Commission Implementing Regulation (EU) 2020/469

- (a) Where a D-ATIS supplements the existing availability of Voice-ATIS, the information shall be identical in both content and format to the applicable Voice-ATIS broadcast. Where real-time meteorological information is included but the data remains within the parameters of the significant change criteria established in points MET.TR.200(e) and (f) of Annex V, the content, for the purpose of maintaining the same designator, shall be considered identical.

- (b) Where a D-ATIS supplements the existing availability of Voice-ATIS and the ATIS requires updating, Voice- ATIS and D-ATIS shall be updated simultaneously.

GM1 ATS.TR.315 Data link-automatic terminal information service (D-ATIS)

ED Decision 2020/008/R

Guidance material relating to D-ATIS is contained in ICAO Doc 9694 'Manual of Air Traffic Services Data Link Applications'.

ATS.TR.320 Automatic terminal information service (voice and/or data link)

Commission Implementing Regulation (EU) 2020/469

- (a) Whenever Voice-ATIS or D-ATIS, or both, are provided:
- (1) the information communicated shall relate to a single aerodrome;
 - (2) the information communicated shall be updated immediately when a significant change occurs;
 - (3) the preparation and dissemination of the ATIS message shall be the responsibility of the air traffic services provider;
 - (4) individual ATIS messages shall be identified by a designator in the form of a letter of the spelling alphabet in accordance with point SERA.14020 of the Annex to Implementing Regulation (EU) No 923/2012. Designators assigned to consecutive ATIS messages shall be in alphabetical order;
 - (5) aircraft shall acknowledge receipt of the information upon establishing communication with the air traffic services unit providing approach control service or the aerodrome control tower or AFIS unit, as appropriate;
 - (6) the appropriate air traffic services unit shall, when replying to the message in point (5) or, in the case of arriving aircraft, at such other time as may be prescribed by the competent authority, provide the aircraft with the current altimeter setting;
 - (7) the meteorological information shall be extracted from the local routine report or local special report.
- (b) When rapidly changing meteorological conditions make it inadvisable to include the meteorological information as in point (a)(7) in the ATIS, the ATIS messages shall indicate that the relevant meteorological information will be given on initial contact with the appropriate air traffic services unit.
- (c) Information contained in a current ATIS, the receipt of which has been acknowledged by the aircraft concerned, need not be included in a directed transmission to the aircraft, with the exception of the altimeter setting, which shall be provided in accordance with point (a).
- (d) If an aircraft acknowledges receipt of an ATIS that is no longer current, the air traffic services unit shall without delay take either of the following actions:
- (1) communicate to the aircraft any element of information which has to be updated;
 - (2) instruct the aircraft to obtain the current ATIS information.

GM1 ATS.TR.320 Automatic terminal information service (voice and/or data link)

ED Decision 2020/008/R

CONTENTS OF ATIS MESSAGES

- (a) Contents of ATIS messages are established in SERA.9010 of Regulation (EU) No 923/2012, and more specifically:
 - (1) the elements of information of ATIS messages containing both arrival and departure information are specified in point (b) of SERA.9010, in the order listed.
 - (2) the elements of information ATIS messages containing arrival information only are specified in point (c) of SERA.9010, in the order listed; and
 - (3) the elements of information of ATIS messages containing departure information only are specified in point (d) of SERA.9010, in the order listed.
- (b) Contents of ATIS messages should be kept as brief as possible.
- (c) Information additional to that specified in SERA.9010 of Regulation (EU) No 923/2012, for example, information already available in AIPs and NOTAM, should only be included when justified in exceptional circumstances..

ATS.TR.325 VOLMET broadcasts and D-VOLMET broadcasts

Commission Implementing Regulation (EU) 2020/469

When so prescribed by the competent authority, HF or VHF VOLMET broadcasts, or D-VOLMET service, or all of those, shall be provided, using standard radiotelephony phraseologies.

GM1 ATS.TR.325 VOLMET broadcasts and D-VOLMET broadcasts

ED Decision 2020/008/R

VOLMET BROADCAST PHRASEOLOGIES

Guidance on standard radiotelephony phraseologies to be used in VOLMET broadcasts is available in ICAO Doc 9377 'Manual on Coordination between Air Traffic Services, Aeronautical information Services and Aeronautical Meteorological Services', Appendix 1.

SECTION 4 - ALERTING SERVICE

ATS.TR.400 Application

Commission Implementing Regulation (EU) 2020/469

- (a) Alerting service shall be provided by the air traffic services units:
- (1) for all aircraft provided with air traffic control service;
 - (2) in so far as practicable, to all other aircraft having filed a flight plan or otherwise known to the air traffic services;
 - (3) to any aircraft known or believed to be the subject of unlawful interference.
- (b) Flight information centres or area control centres shall serve as the central point for collecting all information relevant to a state of emergency of an aircraft operating within the flight information region or control area concerned and for forwarding such information to the appropriate rescue coordination centre.
- (c) In the event of a state of emergency arising to an aircraft while it is under the control of an aerodrome control tower or approach control unit or in contact with an AFIS unit, such unit shall notify immediately the flight information centre or area control centre responsible which shall in turn notify the rescue coordination centre, except that notification of the area control centre, flight information centre, or rescue coordination centre shall not be required if the nature of the emergency is such that the notification would be superfluous.
- (d) Nevertheless, the aerodrome control tower or approach control unit responsible or the relevant AFIS unit shall first alert and take other necessary steps to set in motion all appropriate local rescue and emergency organisations which can give the immediate assistance required, in accordance with local instructions, whenever either of the following situations occurs:
- (1) an aircraft accident has occurred on or in the vicinity of the aerodrome;
 - (2) information is received that the safety of an aircraft which is or will come under the jurisdiction of the aerodrome control tower or of the AFIS unit may have or has been impaired;
 - (3) requested by the flight crew;
 - (4) when otherwise deemed necessary or desirable or the urgency of the situation so requires.

GM1 ATS.TR.400(a)(2) Application

ED Decision 2020/008/R

INSTRUCTIONS ON ALERTING SERVICE PROVISION TO AIRCRAFT OTHERWISE KNOWN TO AIR TRAFFIC SERVICES UNITS

An air traffic services provider should ensure that appropriate instructions, approved by the competent authority, are provided to its air traffic services units regarding the provision of alerting service to aircraft 'otherwise known to the air traffic services'. Such instructions should include options for cases where radio contact is not mandatory and a voluntary radio-communication has been interrupted without proper termination of the contact. These instructions should clarify what kind of information may be used for providing alerting service to aircraft which have not filed a flight plan,

based on the available technologies and local operational conditions (e.g. use of emergency transponder codes or declared emergency of available communication channels).

GM1 ATS.TR.400(b) Application

ED Decision 2020/008/R

COORDINATION FOR ALERTING SERVICE

- (a) When alerting service is required in respect of a flight operated through more than one FIR or control area, and when the position of the aircraft is in doubt, responsibility for coordinating such service should rest with the air traffic services unit of the FIR or control area:
- (1) within which the aircraft was flying at the time of last air-ground radio contact; or
 - (2) that the aircraft was about to enter when last air-ground contact was established at or close to the boundary of two FIRs or control areas; or
 - (3) within which the aircraft's intermediate stop or final destination point is located if the aircraft was not:
 - (i) equipped with suitable two-way radio communication equipment; or
 - (ii) under obligation to transmit position reports.
- (b) The unit responsible for alerting service, in accordance with point (a), should:
- (1) notify units providing alerting service in other affected FIRs or control areas of the emergency phase or phases, in addition to notifying the rescue coordination centre associated with it;
 - (2) request those units to assist in the search for any useful information pertaining to the aircraft presumed to be in an emergency, by all appropriate means and available communication facilities;
 - (3) collect the information gathered during each phase of the emergency and, after verifying it as necessary, transmit it to the rescue coordination centre; and
 - (4) announce the termination of the state of emergency as circumstances dictate.
- (c) In obtaining the necessary information as required under points (b) and (c) of ATS.TR.405, attention is to particularly be given to informing the relevant rescue coordination centre of the distress frequencies available to survivors. Said information is listed in Item 19 of the flight plan but not normally transmitted.

AMC1 ATS.TR.400(d) Application

ED Decision 2020/008/R

ALERTING OF RESCUE AND FIREFIGHTING SERVICES

Local instructions, as in point (d) of ATS.TR.400, should specify the type of information to be provided by the aerodrome control tower or approach control unit responsible or the relevant AFIS unit to the rescue and firefighting services, including type of aircraft and type of emergency and, when available, number of persons on board, and any dangerous goods carried on the aircraft.

ATS.TR.405 Notification to rescue coordination centres

Commission Implementing Regulation (EU) 2020/469

(a) Without prejudice to any other circumstances that may render such notification advisable, air traffic services units shall, except as prescribed in point ATS.TR.420(a), notify rescue coordination centres immediately when an aircraft is considered to be in a state of emergency in accordance with the following:

(1) Uncertainty phase when either of the following situations applies:

- (i) no communication has been received from an aircraft within a period of 30 minutes after the time a communication should have been received, or from the time an unsuccessful attempt to establish communication with such aircraft was first made, whichever is the earlier;
- (ii) an aircraft fails to arrive within 30 minutes of the estimated time of arrival last notified to or estimated by air traffic services units, whichever is the later.

Uncertainty phase does not apply when no doubt exists as to the safety of the aircraft and its occupants.

(2) Alert phase when either of the following situations applies:

- (i) following the uncertainty phase, subsequent attempts to establish communication with the aircraft or inquiries to other relevant sources have failed to reveal any news of the aircraft;
- (ii) an aircraft has been cleared to land and fails to land within 5 minutes of the estimated time of landing and communication has not been re-established with the aircraft;
- (iii) at AFIS aerodromes, under circumstances as prescribed by the competent authority;
- (iv) information has been received which indicates that the operating efficiency of the aircraft has been impaired, but not to the extent that a forced landing is likely;
- (v) an aircraft is known or believed to be the subject of unlawful interference.

Points (i) to (iv) do not apply when evidence exists that would allay apprehension as to the safety of the aircraft and its occupants.

(3) Distress phase when either of the following situations applies:

- (i) following the alert phase, further unsuccessful attempts to establish communication with the aircraft and more widespread unsuccessful inquiries point to the probability that the aircraft is in distress;
- (ii) the fuel on board is considered to be exhausted, or to be insufficient to enable the aircraft to reach safety;
- (iii) information is received which indicates that the operating efficiency of the aircraft has been impaired to the extent that a forced landing is likely;
- (iv) information is received or it is reasonably certain that the aircraft is about to make or has made a forced landing,

Distress phase does not apply when there is reasonable certainty that the aircraft and its occupants are not threatened by grave and imminent danger and do not require immediate assistance.

- (b) The notification shall contain such of the following information as is available in the order listed:
- (1) INCERFA, ALERFA or DETRESFA, as appropriate to the phase of the emergency;
 - (2) agency and person calling;
 - (3) nature of the emergency;
 - (4) significant information from the flight plan;
 - (5) unit which made last contact, time and means used;
 - (6) last position report and how it was determined;
 - (7) colour and distinctive marks of aircraft;
 - (8) dangerous goods carried as cargo;
 - (9) any action taken by the reporting office;
 - (10) other pertinent remarks.
- (c) Such part of the information specified in point (b), which is not available at the time the notification is made to a rescue coordination centre, shall be sought by an air traffic services unit prior to the declaration of a distress phase where time permits and where there is reasonable certainty that this phase will eventuate.
- (d) Further to the notification specified in point (a), air traffic services units shall, without delay, furnish the rescue coordination centre with either of the following:
- (1) any useful additional information, especially on the development of the state of emergency through subsequent phases;
 - (2) information that the emergency situation no longer exists.

GM1 ATS.TR.405(a)(1) Notification to rescue coordination centres

ED Decision 2020/008/R

AIRCRAFT REPORT FOR THE PURPOSES OF UNCERTAINTY PHASE

When no report from an aircraft has been received within a reasonable period of time (which may be a specified interval prescribed on the basis of regional air navigation agreements) after a scheduled or expected reporting time, the air traffic services unit should, within the stipulated period of 30 minutes, endeavour to obtain such report in order to be in a position to apply the provisions relevant to the 'Uncertainty Phase' should circumstances warrant such application.

GM1 ATS.TR.405(a)(2)(ii) Notification to rescue coordination centres

ED Decision 2020/008/R

MISSED AIRCRAFT REPORT — ACTIONS OF THE AERODROME CONTROL TOWER

When an aircraft fails to report after having been transferred to an aerodrome control tower, or, having once reported, ceases radio contact and in either case fails to land 5 minutes after the expected

landing time, the same aerodrome control tower should, in accordance with point (c) of ATS.TR.400, report the situation to the approach control unit, ACC or flight information centre, or to the rescue coordination centre or rescue sub-centre.

GM1 ATS.TR.405(a)(2)(iii) Notification to rescue coordination centres

ED Decision 2020/008/R

MISSED AIRCRAFT REPORT — ACTIONS OF THE AFIS UNIT

When an aircraft fails to report to or ceases radio contact with an AFIS unit under the circumstances established by the competent authority, the same AFIS unit should, in accordance with point (c) of ATS.TR.400, report the situation to the approach control unit, ACC or flight information centre, or to the rescue coordination centre or rescue sub-centre.

GM1 ATS.TR.405(c) Notification to rescue coordination centres

ED Decision 2020/008/R

INFORMATION FOR THE PURPOSES OF ALERTING SERVICE

In case of missing information specified in point (b) of ATS.TR.405, the air traffic services units should clearly indicate to the rescue coordination centre the information not available at the time of the notification of the distress phase.

GM1 ATS.TR.405(d) Notification to rescue coordination centres

ED Decision 2020/008/R

CANCELLATION OF ACTION(S) RELATED TO ALERTING SERVICE

The cancellation of action(s) initiated by the rescue coordination centre is the responsibility of that centre.

ATS.TR.410 Use of communication facilities

Commission Implementing Regulation (EU) 2020/469

Air traffic services units shall, as necessary, use all available communication facilities to endeavour to establish and maintain communication with an aircraft in a state of emergency, and to request news of the aircraft.

ATS.TR.415 Plotting aircraft in a state of emergency

Commission Implementing Regulation (EU) 2020/469

When a state of emergency is considered to exist, the air traffic services unit or units aware of the emergency shall plot the flight of the aircraft involved on a chart or other appropriate tool in order to determine the probable future position of the aircraft and its maximum range of action from its last known position.

AMC1 ATS.TR.415 Plotting aircraft in a state of emergency

ED Decision 2020/008/R

PLOTTING AIRCRAFT IN A STATE OF EMERGENCY WHERE ATS SURVEILLANCE SERVICES ARE PROVIDED

The progress of an aircraft in emergency should be monitored and (whenever possible) plotted on the situation display until the aircraft passes out of coverage of the ATS surveillance system, and position information should be provided to all air traffic services units which may be able to give assistance to the aircraft. Transfer to adjacent sectors should also be effected when appropriate.

ATS.TR.420 Information to the operator

Commission Implementing Regulation (EU) 2020/469

- (a) When an area control centre or a flight information centre decides that an aircraft is in the uncertainty or the alert phase, it shall, when practicable, advise the aircraft operator prior to notifying the rescue coordination centre.
- (b) Whenever practicable, an area control centre or flight information centre shall, without delay, communicate all information notified to the rescue coordination centre to the aircraft operator.

ATS.TR.425 Information to aircraft operating in the vicinity of an aircraft in a state of emergency

Commission Implementing Regulation (EU) 2020/469

- (a) When it has been established by an air traffic services unit that an aircraft is in a state of emergency, other aircraft known to be in the vicinity of the aircraft involved shall, except as provided in point (b), be informed of the nature of the emergency as soon as practicable.
- (b) When an air traffic services unit knows or believes that an aircraft is being subjected to unlawful interference, no reference shall be made in air traffic services air-ground communications to the nature of the emergency unless it has first been referred to in communications from the aircraft involved and it is certain that such reference will not aggravate the situation.

ANNEX V — PART-MET

SPECIFIC REQUIREMENTS FOR PROVIDERS OF METEOROLOGICAL SERVICES

SUBPART A — ADDITIONAL ORGANISATION REQUIREMENTS FOR PROVIDERS OF METEOROLOGICAL SERVICES (MET.OR)

SECTION 1 — GENERAL REQUIREMENTS

MET.OR.100 Meteorological data and information

Regulation (EU) 2017/373

- (a) A meteorological services provider shall provide operators, flight crew members, air traffic services units, search and rescue services units, aerodrome operators, accident and incident investigation bodies, and other service providers and aviation entities with the meteorological information necessary for the performance of their respective functions, as determined by the competent authority.
- (b) A meteorological services provider shall confirm the operationally desirable accuracy of the information distributed for operations, including the source of such information, whilst also ensuring that such information is distributed in a timely manner and updated, as required.

GM1 MET.OR.100 Meteorological data and information

ED Decision 2022/004/R

GENERAL — TERMS IN PART-MET

Whereas ‘provide’ is used solely in connection with the provision of MET service, ‘issue’ is used solely in connection with cases where the obligation specifically extends to sending out (disseminate) the information to a user.

Furthermore, ‘supply’ is used solely in connection with cases where either ‘issue’ or ‘disseminate’ applies.

GM2 MET.OR.100 Meteorological data and information

ED Decision 2022/004/R

DATA AND INFORMATION RELIABILITY

Owing to the variability of meteorological elements in space and time, to limitations of observing techniques, and to limitations caused by the definitions of some of the elements, the specific value of any of the elements given in a meteorological report or in a forecast is understood to be the best approximation to the actual conditions at the time of observation or the most probable value that the element is likely to assume during the period of the forecast, respectively. Similarly, when the time of occurrence or change of an element is given in a forecast, this time is understood to be the most probable time.

AMC1 MET.OR.100(a) Meteorological data and information

ED Decision 2020/008/R

INFORMATION TO BE PROVIDED

An agreement between the meteorological services provider and the appropriate ATS unit should be established to cover:

- (a) the provision in air traffic services units of displays related to semi-automatic observing systems or automatic observing systems;
- (b) the calibration and maintenance of these displays/instruments;
- (c) the use to be made of these displays/instruments by air traffic services personnel;
- (d) as and where necessary, supplementary visual observations, such as meteorological phenomena of operational significance in the climb-out and approach areas, if and when made by air traffic services personnel to update or supplement the information supplied by the meteorological station;
- (e) meteorological information obtained from aircraft taking off or landing such as on wind shear; and
- (f) if available, meteorological information obtained from ground weather radar.

GM1 MET.OR.100(a) Meteorological data and information

ED Decision 2017/001/R

OTHER AVIATION ENTITIES

The competent authority determines who may be the 'other service providers and aviation entities' that could be provided with the necessary meteorological information.

MET.OR.105 Retention of meteorological information

Regulation (EU) 2017/373

- (a) A meteorological services provider shall retain meteorological information issued for a period of at least 30 days from the date of issue.
- (b) This meteorological information shall be made available, on request, for inquiries or investigations and, for these purposes, shall be retained until the inquiry or investigation is completed.

GM1 MET.OR.105(b) Retention of meteorological information

ED Decision 2020/008/R

GENERAL

The competent authority determines who may be provided with meteorological information about inquiries and investigations concerning aviation.

MET.OR.110 Meteorological information exchange requirements

Regulation (EU) 2017/373

A meteorological services provider shall ensure it has systems and processes in place, as well as access to suitable telecommunications facilities to:

- (a) enable the exchange of operational meteorological information with other meteorological services providers;
- (b) provide the required meteorological information to the users in a timely manner.

GM1 MET.OR.110 Meteorological information exchange requirements

ED Decision 2022/004/R

GENERAL

Operational meteorological information is disseminated to international OPMET databanks and to centres responsible for the operation of the aeronautical fixed service Internet-based services.

GM2 MET.OR.110 Meteorological information exchange requirements

ED Decision 2020/008/R

OPMET DATABANK

The list of relevant meteorological exchange requirements for OPMET can be found in the TABLE MET II-1, TABLE MET II-2, TABLE MET II-3, and TABLE MET II-EUR-1 of Volume II of ICAO Doc 7754 ('EUROPEAN (EUR) AIR NAVIGATION PLAN').

GM1 MET.OR.110(a) Meteorological information exchange requirements

ED Decision 2017/001/R

AREA FORECASTS — LOW-LEVEL FLIGHTS

Area forecasts for low-level flights prepared in support of the issuance of AIRMET information are exchanged between aerodrome meteorological offices and/or meteorological watch offices responsible for the issuance of flight documentation for low-level flights in the flight information regions concerned.

MET.OR.115 Meteorological bulletins

Regulation (EU) 2021/1338

The meteorological services provider responsible for the area concerned shall provide meteorological bulletins to the relevant users.

MET.OR.120 Notification of discrepancies to the world area forecast centres (WAFCs)

Regulation (EU) 2021/1338

The meteorological services provider using WAFS SIGWX forecasts shall notify the WAFc concerned immediately if significant discrepancies are detected or reported in respect of WAFS SIGWX forecasts concerning:

- (a) icing, turbulence, cumulonimbus clouds that are obscured, frequent, embedded, or occurring at a squall line, and sandstorms or dust storms;
- (b) volcanic eruptions or a release of radioactive materials into the atmosphere of significance to aircraft operations.

GM1 MET.OR.120 Notification of discrepancies to the world area forecast centres (WAFCs)

ED Decision 2020/008/R

REPORTING — SIGNIFICANT DISCREPANCIES

Guidance on reporting significant discrepancies is provided in ICAO Doc 8896 'Manual of Aeronautical Meteorological Practice' as last amended.

SECTION 2 — SPECIFIC REQUIREMENTS

CHAPTER 1 — REQUIREMENTS FOR AERONAUTICAL METEOROLOGICAL STATIONS

MET.OR.200 Meteorological reports and other information

Regulation (EU) 2021/1338

- (a) An aeronautical meteorological station shall issue:
 - (1) local routine report at fixed intervals, only for dissemination at the aerodrome of origin;
 - (2) local special report, only for dissemination at the aerodrome of origin;
 - (3) METAR at half-hourly intervals at aerodromes serving scheduled international commercial air transport operations for dissemination beyond the aerodrome of origin;
- (b) Notwithstanding point (a)(3), the aeronautical meteorological station may issue hourly METAR and SPECI for dissemination beyond the aerodrome of origin, for aerodromes not serving scheduled international commercial air transport operations, as determined by the competent authority;
- (c) An aeronautical meteorological station shall inform the air traffic service units and aeronautical information service of an aerodrome of changes in the serviceability status of the automated equipment used for assessing runway visual range;
- (d) An aeronautical meteorological station shall report to the associated air traffic services unit, aeronautical information services unit, and meteorological watch office the occurrence of pre-eruption volcanic activity, volcanic eruptions and volcanic ash cloud;
- (e) An aeronautical meteorological station shall establish a list of criteria to provide local special reports in consultation with the appropriate ATS units, operators and others concerned.

GM1 MET.OR.200(a) Meteorological reports and other information

ED Decision 2017/001/R

OBSERVATIONS AND REPORTS

The observations form the basis for the preparation of reports. At aerodromes, the routine observations are supplemented by special observations whenever specified changes occur in respect of surface wind, visibility, runway visual range, present weather, clouds and/or air temperature.

AMC1 MET.OR.200(a) Meteorological reports and other information

ED Decision 2022/004/R

ROUTINE OBSERVATIONS

Aeronautical meteorological stations should make routine observations throughout the 24 hours of each day or as determined by the competent authority.

GM1 MET.OR.200(a)(2) Meteorological reports and other information

ED Decision 2022/004/R

LOCAL SPECIAL REPORTS

Local special reports should be transmitted to local air traffic services units as soon as the specified conditions occur.

By agreement between the aeronautical meteorological station and the appropriate ATS unit, local special reports are not required to be disseminated in respect of:

- (a) any element for which there is in the local air traffic services unit a display corresponding to the one in the meteorological station, and where arrangements are in force for the use of this display to update information included in local routine reports and local special reports; and
- (b) runway visual range, when all changes of one or more steps on the reporting scale in use are being reported to the local air traffic services unit by an observer on the aerodrome.

AMC1 MET.OR.200(a)(3) Meteorological reports and other information

ED Decision 2017/001/R

METAR

At aerodromes that are not operational throughout the 24 hours, the issuance of a METAR should commence at least 3 hours prior to the aerodrome resuming operations, or as agreed between the meteorological services provider and the operators concerned to meet pre-flight and in-flight planning requirements for flights due to arrive at the aerodrome as soon as it is opened for use.

AMC2 MET.OR.200(a)(3) Meteorological reports and other information

ED Decision 2022/004/R

DISSEMINATION OF METAR

METAR, and corrections thereto, should be disseminated to international OPMET databanks and to centres responsible for the operation of aeronautical fixed service Internet-based services.

GM1 MET.OR.200(a)(3) Meteorological reports and other information

ED Decision 2022/004/R

DISSEMINATION OF METAR

Procedures for disseminating METAR to users are described in ICAO EUR Doc 018 'EUR OPMET DATA MANAGEMENT HANDBOOK'.

AMC1 MET.OR.200(b) Meteorological reports and other information

ED Decision 2022/004/R

SPECI

Where required, SPECI should be issued whenever changes when the following criteria are met:

- (a) when the mean surface wind direction has changed by 60° or more from that given in the latest report, the mean speed before and/or after the change being 10 kt or more;
- (b) when the mean surface wind speed has changed by 10 kt or more from that given in the latest local report;
- (c) when the variation from the mean surface wind speed (gusts) has changed by 10 kt or more from that at the time of the latest local report, the mean speed before and/or after the change being 15 kt or more;
- (d) when the onset, cessation or change in intensity of any of the following weather phenomena occurs:
 - (1) freezing precipitation;
 - (2) moderate or heavy precipitation, including showers thereof; and
 - (3) thunderstorm, with precipitation;
- (e) when the onset or cessation of any of the following weather phenomena occurs:
 - (1) freezing fog;
 - (2) thunderstorm, without precipitation;
- (f) when the amount of a cloud layer below 1 500 ft (450 m) changes:
 - (1) from scattered (SCT) or less to broken (BKN) or overcast (OVC); or
 - (2) from BKN or OVC to SCT or less.

AMC2 MET.OR.200(b) Meteorological reports and other information

ED Decision 2022/004/R

DISSEMINATION OF SPECI

SPECI dissemination should be identical to METAR dissemination.

GM1 MET.OR.200(b) Meteorological reports and other information

ED Decision 2022/004/R

DISSEMINATION OF SPECI

SPECI representing a deterioration of meteorological conditions should be disseminated immediately after the observation.

SPECI representing a deterioration of one weather element and an improvement in another weather element should also be disseminated immediately after the observation and should then be treated as deterioration reports.

GM2 MET.OR.200(b) Meteorological reports and other information

ED Decision 2022/004/R

DISSEMINATION OF SPECI

A SPECI representing an improvement in conditions should be disseminated only after the improvement has been maintained for 10 minutes; it should be amended before dissemination, if necessary, to indicate the conditions prevailing at the end of that 10-minute period.

GM3 MET.OR.200(b) Meteorological reports and other information

ED Decision 2022/004/R

DISSEMINATION OF SPECI

Procedures for disseminating SPECI to users are described in ICAO EUR Doc 018 'EUR OPMET DATA MANAGEMENT HANDBOOK'.

AMC1 MET.OR.200(d) Meteorological reports and other information

ED Decision 2022/004/R

VOLCANIC ACTIVITY REPORT

The report of occurrence of pre-eruption volcanic activity, volcanic eruptions and volcanic ash clouds should be made in the format of a volcanic activity report comprising the following meteorological information in the order indicated:

- (a) message type, VOLCANIC ACTIVITY REPORT;
- (b) station identifier, location indicator or name of station;
- (c) date/time of message;
- (d) location of volcano and name, if known; and
- (e) concise description of the event including, as appropriate, level of intensity of volcanic activity, occurrence of an eruption and its date and time and the existence of a volcanic ash cloud in the area together with direction of ash cloud movement and height.

MET.OR.205 Reporting of meteorological elements

Commission Implementing Regulation (EU) 2020/469

An aeronautical meteorological station shall report:

- (a) surface wind direction and speed;
- (b) visibility;
- (c) runway visual range, if applicable;
- (d) present weather at the aerodrome and its vicinity;
- (e) clouds;
- (f) air temperature and dew point temperature;
- (g) atmospheric pressure;
- (h) supplementary information when applicable.

Where authorised by the competent authority, at aerodromes not serving scheduled international commercial air transport operations, an aeronautical meteorological station may report only a subset of the meteorological elements as relevant to the types of flights at that aerodrome. This data set shall be published in the aeronautical information publication.

MET.OR.210 Observing meteorological elements

Commission Implementing Regulation (EU) 2020/469

An aeronautical meteorological station shall observe and/or measure:

- (a) surface wind direction and speed;
- (b) visibility;
- (c) runway visual range, if applicable;
- (d) present weather at the aerodrome and its vicinity;
- (e) clouds;
- (f) air temperature and dew point temperature;
- (g) atmospheric pressure;
- (h) supplementary information, when applicable:

Where authorized by the competent authority, at aerodromes not serving scheduled international commercial air transport operations, an aeronautical meteorological station may observe and/or measure only a subset of the meteorological elements as relevant to the types of flights at that aerodrome. This data set shall be published in the aeronautical information publication.

AMC1 MET.OR.210 Observing meteorological elements

ED Decision 2022/004/R

DISPLAY

Where automated equipment forms part of an integrated semi-automatic observing system or automatic observing system, displays of data which are made available to the local ATS units should be a subset of and displayed parallel to those available in the aeronautical meteorological stations or

aerodrome meteorological offices. In those displays, each meteorological element should be annotated to identify, as appropriate, the locations for which the element is representative.

AMC2 MET.OR.210 Observing meteorological elements

ED Decision 2020/008/R

CLIMATOLOGICAL INFORMATION

- (a) Meteorological observations for regular and alternate aerodromes should be collected, processed and stored in a form suitable for the preparation of aerodrome climatological information.
- (b) Aeronautical climatological information should be exchanged on request between meteorological services providers.

CHAPTER 2 — REQUIREMENTS FOR AERODROME METEOROLOGICAL OFFICES

MET.OR.215 Forecasts and other information

Regulation (EU) 2017/373

An aerodrome meteorological office shall:

- (a) prepare and/or obtain forecasts and other relevant meteorological information necessary for the performance of its respective functions for flights with which it is concerned, as determined by the competent authority;
- (b) provide forecasts and/or warnings for local meteorological conditions on aerodromes for which it is responsible;
- (c) keep the forecasts and warnings under continuous review and issue amendments promptly when necessary, and cancel any forecast of the same type previously issued for the same place and for the same period of validity or part thereof;
- (d) provide briefing, consultation and flight documentation to flight crew members and/or other flight operations personnel;
- (e) provide climatological information;
- (f) provide its associated air traffic services unit, aeronautical information service unit and meteorological watch office with information received on pre-eruption volcanic activity, a volcanic eruption or volcanic ash cloud;
- (g) provide, if applicable, meteorological information to search and rescue services units and maintain liaison with the search and rescue services unit(s) throughout a search and rescue operation;
- (h) provide meteorological information to relevant aeronautical information services units, as necessary, for the conduct of their functions;
- (i) prepare and/or obtain forecast and other relevant meteorological information necessary for the performance of the ATS units functions in accordance with point [MET.OR.242](#);
- (j) provide its associated air traffic services unit, aeronautical information service unit and meteorological watch offices with information received on the release of radioactive materials into the atmosphere.

AMC1 MET.OR.215(a) Forecasts and other information

ED Decision 2017/001/R

METEOROLOGICAL DATA TYPE

On request by the operator, the meteorological information supplied for flight planning should include data for the determination of the lowest usable flight level.

GM1 MET.OR.215(a) Forecasts and other information

ED Decision 2017/001/R

PREPARATION OF FORECASTS

The extent of the aerodrome meteorological office responsibilities to prepare forecasts may relate to the local availability and use of en-route and aerodrome forecast material received from other offices.

GM2 MET.OR.215(a) Forecasts and other information

ED Decision 2017/001/R

COMPETENT AUTHORITY

The competent authority identifies the types of forecasts and other meteorological information that need to be provided by the aerodrome meteorological office to flights with which it is concerned.

AMC1 MET.OR.215(c) Forecasts and other information

ED Decision 2017/001/R

FORMAT OF FORECASTS

The length of the forecast messages and the number of changes indicated in the forecast should be kept to a minimum.

GM1 MET.OR.215(c) Forecasts and other information

ED Decision 2017/001/R

AUTOMATIC CANCELLATION

The issue of a new forecast by an aerodrome meteorological office, such as a routine aerodrome forecast, automatically cancels any forecast of the same type previously issued for the same place and for the same period of validity or part thereof.

GM2 MET.OR.215(c) Forecasts and other information

ED Decision 2020/008/R

TAF CONTINUOUS REVIEW GUIDANCE

Guidance on methods to keep Terminal Aerodrome Forecasts (TAF) under continuous review is given in Chapter 3 of ICAO Doc 8896 'Manual of Aeronautical Meteorological Practice' as last amended.

GM3 MET.OR.215(c) Forecasts and other information

ED Decision 2017/001/R

AMENDMENTS TO WARNINGS

If it is known that an existing warning no longer accurately describes the existing or expected future evolution of the phenomena, a new warning, correctly describing the hazard should be issued (avoiding the use of the code word 'AMD', not included in the templates for warnings), followed immediately by the cancellation of the original, erroneous one. The new warning should be issued before the cancellation in order to ensure there is always a warning in force and that the cancellation is not mistakenly understood to mean the hazard has completely dissipated.

GM1 MET.OR.215(d) Forecasts and other information

ED Decision 2017/001/R

BRIEFING AND CONSULTATION

- (a) Briefing should be understood as being preparatory meteorological information on existing and/or expected meteorological conditions.
- (b) Consultation should be understood as discussion, including answers to questions, with a meteorologist or another qualified person of existing and/or expected meteorological conditions relating to flight operations.
- (c) The purpose of briefing and consultation is to provide the latest available information on existing and expected meteorological conditions along the route to be flown and at the aerodrome of intended landing, and on alternate aerodromes and other aerodromes as relevant, in order to either explain or amplify the information contained in the flight documentation.

GM2 MET.OR.215(d) Forecasts and other information

ED Decision 2017/001/R

PRE-FLIGHT PLANNING

The service for pre-flight planning should be confined to flights originating within the territory of the State concerned.

GM3 MET.OR.215(d) Forecasts and other information

ED Decision 2017/001/R

FLIGHT DOCUMENTATION

'Flight documentation', for the purpose of meteorology, is understood as being documents, including charts or forms, containing meteorological information for a flight.

AMC1 MET.OR.215(e) Forecasts and other information

ED Decision 2017/001/R

CLIMATOLOGICAL INFORMATION

The aerodrome meteorological office should make available such climatological tables within a time period as agreed between the competent authority and the relevant user.

AMC1 MET.OR.215(f) Forecasts and other information

ED Decision 2017/001/R

AIS — NOTAM/ASHTAM AND AIC

The aerodrome meteorological office should provide the relevant aeronautical information service provider with meteorological information:

- (a) necessary for the preparation of NOTAM or ASHTAM, including, in particular, information on the establishment, withdrawal and significant changes in operation of aeronautical meteorological services sufficiently in advance of the effective date to permit issuance of NOTAM; and

- (b) necessary for the preparation of aeronautical information circulars, including, in particular, meteorological information on expected important changes in aeronautical meteorological procedures, services and facilities provided.

AMC1 MET.OR.215(g) Forecasts and other information

ED Decision 2017/001/R

SEARCH AND RESCUE

To facilitate search and rescue operations, the aerodrome meteorological office or meteorological watch office should provide:

- (a) complete and detailed meteorological information on the current and forecast meteorological conditions in the search area;
- (b) current and forecast conditions en-route, covering flights by search aircraft from and returning to the aerodrome from which the search is being conducted; and
- (c) on request from the rescue coordination centre, meteorological information required by ships undertaking search and rescue operations.

MET.OR.220 Aerodrome forecasts

Regulation (EU) 2017/373

- (a) An aerodrome meteorological office shall issue aerodrome forecasts as a TAF at a specified time.
- (b) When issuing TAF, the aerodrome meteorological office shall ensure that not more than one TAF is valid at an aerodrome at any given time.

AMC1 MET.OR.220(a) Aerodrome forecasts

ED Decision 2022/004/R

DISSEMINATION OF TAF

TAF, as well as corrections and amendments thereto, should be disseminated to international OPMET databanks and to centres responsible for the operation of aeronautical fixed service Internet-based services.

GM1 MET.OR.220(a) Aerodrome forecasts

ED Decision 2022/004/R

DISSEMINATION OF TAF

Guidance on the dissemination of TAF to users is provided in ICAO EUR Doc 018 'EUR OPMET DATA MANAGEMENT HANDBOOK'.

MET.OR.225 Forecasts for landing

Regulation (EU) 2017/373

- (a) An aerodrome meteorological office shall prepare forecasts for landing as determined by the competent authority.
- (b) This forecast for landing shall be issued in the form of a TREND forecast.
- (c) The period of validity of a TREND forecast shall be 2 hours from the time of the report which forms part of the landing forecast.

GM1 MET.OR.225 Forecasts for landing

ED Decision 2017/001/R

RANGE

Landing forecasts are intended to meet the requirements of local users and of aircraft within about one hour's flying time from the aerodrome.

GM1 MET.OR.225(a) Forecasts for landing

ED Decision 2017/001/R

PREPARATION

As all the aerodromes do not need to be provided with forecasts for landing, the competent authority determines on which aerodromes these types of forecasts will be provided by the aerodrome meteorological office.

GM1 MET.OR.225(b) Forecasts for landing

ED Decision 2022/004/R

TREND FORECAST

A TREND forecast is understood as being a concise statement of the expected significant changes in the meteorological conditions at that aerodrome to be appended to a METAR or SPECI, and if agreed between the aeronautical meteorological station and the appropriate ATS unit, in a local routine report and a local special report as well.

MET.OR.230 Forecasts for take-off

Regulation (EU) 2017/373

An aerodrome meteorological office shall:

- (a) prepare forecasts for take-off as determined by the competent authority;
- (b) supply forecasts for take-off to operators and flight crew members on request within the 3 hours before the expected time of departure.

MET.OR.235 Aerodrome warnings and wind shear warnings and alerts

Regulation (EU) 2017/373

An aerodrome meteorological office shall:

- (a) provide aerodrome warnings information;
- (b) prepare wind shear warnings for aerodromes where wind shear is considered a factor, in accordance with local arrangements with the appropriate ATS unit and operators concerned;
- (c) issue, at aerodromes where wind shear is detected by automated, ground-based, wind shear remote-sensing or detection equipment, wind shear alerts generated by these systems;
- (d) cancel warnings when the conditions are no longer occurring and/or no longer expected to occur at the aerodrome.

GM1 MET.OR.235 Aerodrome warnings and wind shear warnings and alerts

ED Decision 2017/001/R

AUTOMATED DETECTION EQUIPMENT

The decision to install an automated wind shear detection equipment should be based on the local meteorological and air traffic considerations. Where such equipment is installed, wind shear alerts should be issued in accordance with [MET.OR.235\(c\)](#).

AMC1 MET.OR.235(c) Aerodrome warnings and wind shear warnings and alerts

ED Decision 2022/004/R

WIND SHEAR FOLLOW-UP

Wind shear alerts should be updated at least every minute. They should be cancelled as soon as the headwind/tailwind change falls below 15 kt.

GM1 MET.OR.235(c) Aerodrome warnings and wind shear warnings and alerts

ED Decision 2020/008/R

WIND SHEAR ALERTS

Wind shear alerts are expected to complement wind shear warnings and together are intended to enhance situational awareness of wind shear.

GM1 MET.OR.235(d) Aerodrome warnings and wind shear warnings and alerts

ED Decision 2020/008/R

CANCELLATION OF WARNINGS

The criteria for the cancellation of wind shear warnings are defined locally for each aerodrome, as agreed between the aerodrome meteorological office, the appropriate ATS units and the operators concerned.

MET.OR.240 Information for use by operator or flight crew

Regulation (EU) 2021/1338

An aerodrome meteorological office shall provide operators and flight crew members with the latest available:

- (a) forecasts, originating from the WAFS, of the elements listed in points (1) and (2) of point [MET.OR.275\(a\)](#);
- (b) METAR or SPECI, including TREND, TAF or amended TAF for the aerodromes of departure and intended landing, and for take-off, en-route and destination alternate aerodromes;
- (c) aerodrome forecasts for take-off;
- (d) SIGMET and special air-reports relevant to the whole route;
- (e) volcanic ash, tropical cyclone and space weather advisory information relevant to the whole route;
- (f) area forecasts for low-level flights prepared in combination with the issuance of AIRMET, and AIRMET relevant to the whole route;
- (g) aerodrome warnings for the local aerodrome;
- (h) meteorological satellite images;
- (i) ground-based weather radar information.

GM1 MET.OR.240(a) Information for use by operator or flight crew

ED Decision 2022/004/R

GENERAL

Forecasts of upper-air humidity and geopotential altitude of flight levels are used only in automatic flight planning and do not need to be displayed.

GM1 MET.OR.240(b) Information for use by operator or flight crew

ED Decision 2022/004/R

GENERAL

For aerodromes not serving scheduled international commercial air transport operations within European Union:

- (a) an aeronautical meteorological station may disseminate METAR on an hourly basis, as well as SPECI, as necessary; and

- (b) such information should be made available and may include TREND.

GM1 MET.OR.240(d) Information for use by operator or flight crew

ED Decision 2022/004/R

SIGMET

Special air-reports supplied to operators and flight crew members will be those not already used in the preparation of SIGMET.

GM1 MET.OR.240(e) Information for use by operator or flight crew

ED Decision 2022/004/R

SPACE WEATHER ADVISORY

Space weather advisory information is received from space weather centres (SWXCs) in accordance with ICAO Annex 3 'Meteorological Service for International Air Navigation' and ICAO Doc 10100 'Manual on Space Weather Information in Support of International Air Navigation'.

MET.OR.242 Information to be provided to air traffic services units

Regulation (EU) 2021/1338

- (a) An aerodrome meteorological office shall provide, as necessary, its associate aerodrome control tower and AFIS unit with:
- (1) local routine report, local special report, METAR, SPECI, TAF and TREND and amendments thereto;
 - (2) SIGMET, AIRMET, wind shear warnings and alerts and aerodrome warnings;
 - (3) any additional meteorological information agreed upon locally, such as forecasts of surface wind for the determination of possible runway changes;
 - (4) information received on volcanic ash cloud, for which a SIGMET has not already been issued, as agreed between the aerodrome meteorological office and the aerodrome control tower or the AFIS unit concerned;
 - (5) information received on pre-eruption volcanic activity and/or a volcanic eruption as agreed between the aerodrome meteorological office and the aerodrome control tower or the AFIS unit concerned.
- (b) An aerodrome meteorological office shall provide its associate approach control unit with:
- (1) local routine report, local special report, METAR, SPECI, TAF and TREND and amendments thereto;
 - (2) SIGMET, AIRMET, wind shear warnings and alerts, appropriate special air-reports and aerodrome warnings;
 - (3) any additional meteorological information agreed upon locally;
 - (4) information received on volcanic ash cloud, for which a SIGMET has not already been issued, as agreed between the aerodrome meteorological office and the approach control unit concerned;

- (5) information received on pre-eruption volcanic activity and/or a volcanic eruption as agreed between the aerodrome meteorological office and the approach control unit concerned.

CHAPTER 3 — REQUIREMENTS FOR METEOROLOGICAL WATCH OFFICES

MET.OR.245 Meteorological watch and other information

Regulation (EU) 2021/1338 (EU) 2021/1338

Within its area of responsibility, the meteorological watch office shall:

- (a) maintain continuous watch over meteorological conditions affecting flight operations;
- (b) coordinate with the organisation responsible for the provision of NOTAM and/or ASHTAM to ensure that meteorological information on volcanic ash included in SIGMET and NOTAM and/or ASHTAM is consistent;
- (c) coordinate with selected volcano observatories to ensure that information on volcanic activity is received in an efficient and timely manner;
- (d) provide its associated VAAC with information received on pre-eruption volcanic activity, a volcanic eruption and volcanic ash cloud for which a SIGMET has not already been issued;
- (e) provide its aeronautical information service units with information received on the release of radioactive materials into the atmosphere in the area or adjacent areas for which it maintains watch and for which a SIGMET has not already been issued;
- (f) provide its associated area control centre and flight information centre (ACC/FIC), as necessary, with relevant:
 - (1) METAR and SPECI, including current pressure data for aerodromes and other locations, TAF, TREND and amendments thereto;
 - (2) forecasts of upper winds, upper-air temperatures and significant en-route weather phenomena and amendments thereto, SIGMET, AIRMET and appropriate special air-reports;
 - (3) any other meteorological information required by the ACC/FIC to meet requests from aircraft in flight;
 - (4) information received on volcanic ash cloud, for which a SIGMET has not already been issued, as agreed between the meteorological watch office and the ACC/FIC;
 - (5) information received concerning the release of radioactive material into the atmosphere, as agreed between the meteorological watch office and the ACC/FIC;
 - (6) tropical cyclone advisory issued by a TCAC in its area of responsibility;
 - (7) volcanic ash advisory issued by a VAAC in its area of responsibility;
 - (8) information received on pre-eruption volcanic activity and/or a volcanic eruption as agreed between the meteorological watch office and the ACC/FIC;
- (g) when available, provide the relevant air traffic services units, in accordance with local agreement, with information regarding the release into the atmosphere of toxic chemicals which could affect the airspace used by flights within their area of responsibility.

AMC1 MET.OR.245(a) Meteorological watch and other information

ED Decision 2017/001/R

BOUNDARIES

The boundaries of the area over which meteorological watch is to be maintained by a meteorological watch office should be coincident with the boundaries of a flight information region or a control area or a combination of flight information regions and/or control areas.

AMC1 MET.OR.245(f)(3) Meteorological watch and other information

ED Decision 2022/004/R

AIRCRAFT IN FLIGHT

If the information requested from an aircraft in flight is not available in the associated meteorological watch office, that meteorological watch office should request the assistance of another meteorological watch office or another aerodrome meteorological office in providing it.

MET.OR.250 SIGMET

Regulation (EU) 2021/1338

A meteorological watch office shall:

- (a) issue SIGMET;
- (b) ensure that the SIGMET is cancelled when the phenomena are no longer occurring or are no longer expected to occur in the area covered by the SIGMET;
- (c) ensure that the period of validity of a SIGMET is not more than 4 hours, and in the special case of SIGMET for volcanic ash cloud and tropical cyclones, it shall be extended up to 6 hours;
- (d) ensure that SIGMET are issued not more than 4 hours before the commencement of the period of validity. In the special case of SIGMET for volcanic ash cloud and tropical cyclones, SIGMET shall be issued as soon as practicable, but not more than 12 hours before the commencement of the period of validity, and updated at least every 6 hours.

AMC1 MET.OR.250(a) SIGMET

ED Decision 2020/008/R

FIR AND CTA

Meteorological watch offices whose area of responsibility encompasses more than one FIR and/or CTA should provide separate SIGMET for each FIR and/or CTA.

AMC2 MET.OR.250(a) SIGMET

ED Decision 2022/004/R

DISSEMINATION OF SIGMET

SIGMET, and cancellations thereof, should be disseminated to international OPMET databanks and to centres responsible for the operation of aeronautical fixed service Internet-based services.

GM1 MET.OR.250(a) SIGMET

ED Decision 2022/004/R

DISSEMINATION OF SIGMET

Procedures for the dissemination of SIGMET to users are described in ICAO EUR Doc 018 'EUR OPMET DATA MANAGEMENT HANDBOOK'.

AMC1 MET.OR.250(c) SIGMET

ED Decision 2020/008/R

SOURCE

SIGMET concerning volcanic ash clouds and tropical cyclones should be based on advisory information provided by VAACs and tropical cyclone advisory centres (TCACs), respectively.

MET.OR.255 AIRMET

Regulation (EU) 2021/1338

A meteorological watch office shall:

- (a) issue AIRMET when the competent authority has determined that the density of traffic operating below flight level 100, or up to flight level 150 in mountainous areas, or higher, where necessary, warrants the issue of AIRMET in combination with area forecasts for low-level flights;
- (b) cancel the AIRMET when the phenomena are no longer occurring or are no longer expected to occur in the area;
- (c) ensure that the period of validity of an AIRMET is not more than 4 hours.

AMC1 MET.OR.255(a) AIRMET

ED Decision 2022/004/R

DISSEMINATION OF AIRMET

AIRMET, and cancellations thereof, should be disseminated to international OPMET databanks and to centres responsible for the operation of aeronautical fixed service Internet-based services.

GM1 MET.OR.255(a) AIRMET

ED Decision 2022/004/R

DISSEMINATION OF AIRMET

Procedures for the dissemination of AIRMET to users are described in ICAO EUR Doc 018 'EUR OPMET DATA MANAGEMENT HANDBOOK'.

MET.OR.260 Area forecasts for low-level flights

Regulation (EU) 2021/1338

A meteorological watch office shall ensure that:

- (a) in the case of AIRMET being issued in combination with area forecasts for low-level flights in accordance with point [MET.OR.255\(a\)](#), area forecasts for low-level flights are issued every 6

hours for a period of validity of 6 hours and transmitted to the meteorological watch offices concerned not later than 1 hour prior to the beginning of their validity period;

- (b) in the case where the competent authority has determined that the density of traffic operating below flight level 100, or up to flight level 150 in mountainous areas, or higher, where necessary, warrants the routine issue of area forecasts for low-level flights not in combination with AIRMET, the frequency of issue, the form, and the fixed time or period of validity of the area forecast for low-level flights and the criteria for amendments thereto, are as determined by the competent authority.

CHAPTER 4 — REQUIREMENTS FOR VOLCANIC ASH ADVISORY CENTRES (VAACs)

MET.OR.265 Volcanic ash advisory centre responsibilities

Regulation (EU) 2021/1338

In its area of responsibility, the VAAC shall:

- (a) when a volcano has erupted, or is expected to erupt, or volcanic ash is reported, issue advisory information regarding the extent and forecast movement of the volcanic ash cloud;
- (b) coordinate with selected volcano observatories to ensure that information on volcanic activity is received in an efficient and timely manner;
- (c) provide the advisory meteorological information referred to in point (a) at least every 6 hours until such time as the volcanic ash cloud is no longer identifiable from satellite data, no further meteorological reports of volcanic ash are received from the area and no further eruptions of the volcano are reported; and
- (d) maintain a 24-hour watch.

AMC1 MET.OR.265(a) Volcanic ash advisory centre responsibilities

ED Decision 2022/004/R

DISSEMINATION OF VOLCANIC ASH ADVISORY

Volcanic ash advisory information should be disseminated to:

- (a) the European aviation crisis coordination cell;
- (b) international OPMET databanks and to centres responsible for the operation of aeronautical fixed service Internet-based services.

GM1 MET.OR.265(a) Volcanic ash advisory centres (VAACs) responsibilities

ED Decision 2020/008/R

DISTRIBUTION OF METEOROLOGICAL DATA

The AFS address to be used by the VAACs is given in ICAO Doc 9766 'Handbook on the International Airways Volcano Watch (IAVW)'.

GM2 MET.OR.265(a) Volcanic ash advisory centre responsibilities

ED Decision 2022/004/R

DISSEMINATION OF VOLCANIC ASH ADVISORY

Procedures for the dissemination of volcanic ash advisory information to users are described in ICAO EUR Doc 018 'EUR OPMET DATA MANAGEMENT HANDBOOK'.

CHAPTER 5 — REQUIREMENTS FOR TROPICAL CYCLONE ADVISORY CENTRES (TCACs)

MET.OR.270 Tropical cyclone advisory centre responsibilities

Regulation (EU) 2021/1338

In its area of responsibility, the TCAC shall issue:

- (a) advisory information concerning the position of the cyclone centre, changes in intensity at the time of observation, its direction and speed of movement, central pressure and maximum surface wind near the centre;
- (b) updated advisory information to meteorological watch offices for each tropical cyclone, as necessary, but at least every 6 hours.

AMC1 MET.OR.270(a) Tropical cyclone advisory centre responsibilities

ED Decision 2022/004/R

DISSEMINATION OF TROPICAL CYCLONE ADVISORY

Tropical cyclone advisory information should be disseminated to international OPMET databanks and to centres responsible for the operation of aeronautical fixed service Internet-based services.

GM1 MET.OR.270(a) Tropical cyclone advisory centre responsibilities

ED Decision 2022/004/R

DISSEMINATION OF TROPICAL CYCLONE ADVISORY

Procedures for the dissemination of tropical cyclone advisory information to users are described in ICAO EUR Doc 018 'EUR OPMET DATA MANAGEMENT HANDBOOK'.

CHAPTER 6 — REQUIREMENTS FOR WORLD AREA FORECAST CENTRES (WAFCS)

MET.OR.275 World area forecast centre responsibilities

Regulation (EU) 2021/1338 (EU) 2021/1338

- (a) The WAFC shall issue:
 - (1) gridded global forecasts of:
 - (i) upper wind;
 - (ii) upper-air temperature and humidity;
 - (iii) geopotential altitude of flight levels;
 - (iv) flight level and temperature of tropopause;
 - (v) direction, speed and flight level of maximum wind;
 - (vi) cumulonimbus clouds;
 - (vii) icing;
 - (viii) turbulence;
 - (2) global forecasts of significant weather (SIGWX) phenomena, including volcanic activity and release of radioactive materials.
- (b) The WAFC shall ensure that world area forecast system products in digital form are transmitted using binary data communications techniques.

AMC1 MET.OR.275(a) World area forecast centre responsibilities

ED Decision 2022/004/R

DISSEMINATION OF WORLD AREA FORECAST CENTRE (WAF) GRIDDED GLOBAL FORECASTS AND FORECASTS OF SIGNIFICANT WEATHER (SIGWX)

World area forecast centre (WAF) gridded global forecasts and forecasts of significant weather (SIGWX) should be disseminated to:

- (a) other WAFCs;
- (b) centres responsible for the operation of aeronautical fixed service Internet-based services.

SUBPART B — TECHNICAL REQUIREMENTS FOR PROVIDERS OF METEOROLOGICAL SERVICES (MET.TR)

SECTION 1 — GENERAL REQUIREMENTS

MET.TR.115 Meteorological bulletins

Regulation (EU) 2021/1338

- (a) Meteorological bulletins shall be disseminated using specified data types and code forms appropriate to the information being provided.
- (b) Meteorological bulletins containing operational meteorological information shall be disseminated via communication systems appropriate to the information being provided and the users for which it is intended.

AMC1 MET.TR.115(a) Meteorological bulletins

ED Decision 2022/004/R

DATA TYPES AND CODE FORMS FOR METEOROLOGICAL INFORMATION

The data types and code forms applicable to specified meteorological information should be as follows:

- (a) ICAO Meteorological Information Exchange Model (IWXXM) GML form;
- (b) alphanumeric code form;
- (c) abbreviated plain language form;
- (d) 'gridded binary' (GRIB) code form;
- (e) 'binary universal form for the representation of meteorological data' (BUFR) code form;
- (f) portable network graphics (PNG) form.

GM1 MET.TR.115(a) Meteorological bulletins

ED Decision 2022/004/R

DATA TYPES AND CODE FORMS FOR METEOROLOGICAL INFORMATION

The specifications for data types and code forms for meteorological information should be as follows:

- IWXXM GML form;
- IWXXM context (class) diagrams with identified features, types and allowed enumerations are published in the WMO Manual on Codes (WMO-No. 306) Volume I.3, Part D 'Representations derived from data models';
- Guidance on the implementation of IWXXM is provided in ICAO Doc 10003 'Manual on the ICAO Meteorological Information Exchange Model (IWXXM)';
- Guidance on the implementation and exchange of IWXXM in the EUR Region is provided in ICAO EUR Doc 033 'Guidelines for the Implementation of OPMET Data Exchange using IWXXM in the EUR Region';

- Alphanumeric code form as specified in the WMO Manual on Codes (WMO-No. 306),
- Volume I.1, Part A ‘Alphanumeric Codes’;
- Abbreviated plain language form as prescribed in the AMC ([AMC1 MET.TR.115\(a\)](#), [AMC1 MET.TR.200\(a\)](#), [AMC1 MET.TR.200\(a\)\(12\)](#), [AMC3 MET.TR.215\(a\)](#), [AMC1 MET.TR.235\(a\)](#), [AMC1 MET.TR.235\(c\)](#), [AMC2 MET.TR.250\(a\)](#), [AMC1 MET.TR.255\(a\)](#), [AMC1 MET.TR.265](#), [AMC1 MET.TR.270](#)) describing the meteorological information being provided;
- ‘Gridded binary’ (GRIB) code form as specified in the WMO Manual on Codes (WMO-No. 306), Volume I.2, Part B ‘Binary Codes’;
- ‘Binary universal form for the representation of meteorological data’ (BUFR) code form as specified in the WMO Manual on Codes (WMO-No. 306), Volume I.2, Part B ‘Binary Codes’;
- portable network graphics (PNG) form.

GM2 MET.TR.115(a) Meteorological bulletins

ED Decision 2017/001/R

COMPOSITION AND FILING TIMES OF BULLETINS

- (a) Whenever possible, exchanges of operational meteorological information should be made in consolidated bulletins of the same types of meteorological information.
- (b) Meteorological bulletins required for scheduled transmissions should be filed regularly and at the prescribed scheduled times.

GM3 MET.TR.115(a) Meteorological bulletins

ED Decision 2022/004/R

HEADING

Detailed specifications on format and contents of the heading are given in the WMO Publication No 386, 'Manual on the Global Telecommunication System', Volume I, and in ICAO Doc 8896 'ICAO Manual of Aeronautical Meteorological Practice'.

SECTION 2 — SPECIFIC REQUIREMENTS

CHAPTER 1 — TECHNICAL REQUIREMENTS FOR AERONAUTICAL METEOROLOGICAL STATIONS

MET.TR.200 Meteorological reports and other information

Regulation (EU) 2021/1338

- (a) Local routine report, local special report, METAR and SPECI shall contain the following elements in the order indicated:
- (1) identification of the type of report;
 - (2) location indicator;
 - (3) time of the observation;
 - (4) identification of an automated or missing report, when applicable;
 - (5) surface wind direction and speed;
 - (6) visibility;
 - (7) runway visual range, when the reporting criteria are met;
 - (8) present weather;
 - (9) cloud amount, cloud type only for cumulonimbus and towering cumulus clouds and height of cloud base or, where measured, vertical visibility;
 - (10) air temperature and dew-point temperature;
 - (11) QNH and, when applicable, in local routine and local special report, QFE;
 - (12) supplementary information, when applicable.
- (b) In local routine report and local special report:
- (1) if the surface wind is observed from more than one location along the runway, the locations for which these values are representative shall be indicated;
 - (2) when there is more than one runway in use and the surface wind related to these runways is observed, the available wind values for each runway shall be given, and the runways to which the values refer shall be reported;
 - (3) when variations from the mean wind direction are reported in accordance with point [MET.TR.205\(a\)\(3\)\(ii\)\(B\)](#), the two extreme directions between which the surface wind has varied shall be reported;
 - (4) when variations from the mean wind speed (gusts) are reported in accordance with point [MET.TR.205\(a\)\(3\)\(iii\)](#), they shall be reported as the maximum and minimum values of the wind speed attained.
- (c) METAR and SPECI
- (1) METAR and SPECI shall be issued in accordance with the template shown in Appendix 1.
 - (2) METAR shall be filed for transmission not later than 5 minutes after the actual time of observation.

- (d) Information on visibility, runway visual range, present weather and cloud amount, cloud type and height of cloud base shall be replaced in all meteorological reports by the term 'CAVOK' when the following conditions occur simultaneously at the time of observation:
- (1) visibility, 10 km or more, and the lowest visibility is not reported;
 - (2) no cloud of operational significance;
 - (3) no weather of significance to aviation.
- (e) The list of criteria to provide local special report shall include:
- (1) those values which most closely correspond to the operating minima of the operators using the aerodrome;
 - (2) those values which satisfy other local requirements of the air traffic services (ATS) units and of the operators;
 - (3) an increase in air temperature of 2 °C or more from that given in the latest local report, or an alternative threshold value as agreed between the meteorological services providers, the appropriate ATS unit and the operators concerned;
 - (4) the available supplementary information concerning the occurrence of significant meteorological conditions in the approach and climb-out areas;
 - (5) when noise-abatement procedures are applied and the variation from the mean surface wind speed has changed by 5 kt or more from that at the time of the latest local report, the mean speed before and/or after the change being 15 kt or more;
 - (6) when the mean surface wind direction has changed by 60° or more from that given in the latest report, the mean speed before and/or after the change being 10 kt or more;
 - (7) when the mean surface wind speed has changed by 10 kt or more from that given in the latest local report;
 - (8) when the variation from the mean surface wind speed (gusts) has changed by 10 kt or more from that at the time of the latest local report, the mean speed before and/or after the change being 15 kt or more;
 - (9) when the onset, cessation or change in intensity of any of the following weather phenomena occurs:
 - (i) freezing precipitation;
 - (ii) moderate or heavy precipitation, including showers thereof; and
 - (iii) thunderstorm, with precipitation;
 - (10) when the onset or cessation of any of the following weather phenomena occurs:
 - (i) freezing fog;
 - (ii) thunderstorm, without precipitation;
 - (11) when the amount of a cloud layer below 1 500 ft (450 m) changes:
 - (i) from scattered (SCT) or less to broken (BKN) or overcast (OVC); or
 - (ii) from BKN or OVC to SCT or less.

- (f) When so agreed between the meteorological services provider and the competent authority, local special reports and SPECI, when applicable shall be issued whenever the following changes occur:
- (1) when the wind changes through values of operational significance; the threshold values shall be established by the meteorological services provider in consultation with the appropriate ATS unit and operators concerned, taking into account changes in the wind which would:
 - (i) require a change in runway(s) in use;
 - (ii) indicate that the runway tailwind and crosswind components have changed through values representing the main operating limits for typical aircraft operating at the aerodrome;
 - (2) when the visibility is improving and changes to or passes through one or more of the following values, or when the visibility is deteriorating and passes through one or more of the following values:
 - (i) 800, 1 500 or 3 000 m;
 - (ii) 5 000 m, in cases where a significant number of flights are operated in accordance with the visual flight rules;
 - (3) when the runway visual range is improving and changes to or passes through one or more of the following values, or when the runway visual range is deteriorating and passes through one or more of the following values: 50, 175, 300, 550 or 800 m;
 - (4) when the onset, cessation or change in intensity of any of the following weather phenomena occurs:
 - (i) dust storm;
 - (ii) sandstorm;
 - (iii) funnel cloud (tornado or waterspout);
 - (5) when the onset or cessation of any of the following weather phenomena occurs:
 - (i) low drifting dust, sand or snow;
 - (ii) blowing dust, sand or snow;
 - (iii) squall;
 - (6) when the height of base of the lowest cloud layer of BKN or OVC extent is lifting and changes to or passes through one or more of the following values, or when the height of base of the lowest cloud layer of BKN or OVC extent is lowering and passes through one or more of the following values:
 - (i) 100, 200, 500 or 1 000 ft;
 - (ii) 1 500 ft, in cases where significant numbers of flights are operated in accordance with the visual flight rules;
 - (7) when the sky is obscured and the vertical visibility is improving and changes to or passes through one or more of the following values, or when the vertical visibility is deteriorating and passes through one or more of the following values: 100, 200, 500 or 1 000 ft;

- (8) any other criteria based on local aerodrome operating minima, as agreed between the meteorological services providers and the operators.

AMC1 MET.TR.200(a) Meteorological reports and other information

ED Decision 2022/004/R

TEMPLATE FOR LOCAL ROUTINE REPORT AND LOCAL SPECIAL REPORT

Local routine reports and local special reports should be issued in abbreviated plain language, in accordance with the template below.

Template for local routine report (MET REPORT) and local special report (SPECIAL)					
Key:					
M	=	inclusion mandatory;			
C	=	inclusion conditional, dependent on meteorological conditions;			
O	=	inclusion optional.			
Note 1: The ranges and resolutions for the numerical elements included in local routine reports and local special reports are provided in GM1 MET.TR.200(a).					
Note 2: The numbers in the 'Ref.' column are included only for clarity and ease of reference, and are not part of the report.					
Ref.	Element	Detailed content	Template(s)		
1	Identification of the type of report (M)	Type of report	MET REPORT or SPECIAL		
2	Location indicator (M)	ICAO location indicator (M)	nnnn		
3	Time of the observation (M)	Day and actual time of the observation in UTC	nnnnnnZ		
4	Identification of an automated report (C)	Automated report identifier (C)	AUTO		
5	Surface wind (M)	Name of the element (M)	WIND		
		Runway (O)	RWY nn[L] or RWY nn[C] or RWY nn[R]		
		Runway section (O)	TDZ		
		Wind direction (M)	nnn/	VRB BTN nnn/ AND nnn/ or VRB	C A L M
		Wind speed (M)	[ABV]n[n]KT		
		Significant speed variations (C)	MAX[ABV]nn[n] MNMn[n]		
		Significant directional variations (C)	VRB BTN nnn/ AND nnn/	—	

		Runway section (O)	MID		C A L M	
		Wind direction (O)	nnn/	VRB BTN nnn/ AND nnn/ or VRB		
		Wind speed (O)	[ABV]n[n]KT			
		Significant speed variations (C)	MAX[ABV]nn[n] MNMn[n]			
		Significant directional variations (C)	VRB BTN nnn/ AND nnn/	—		
			Runway section (O)	END		C A L M
			Wind direction (O)	nnn/	VRB BTN nnn/ AND nnn/ or VRB	
			Wind speed (O)	[ABV]n[n]KT		
			Significant speed variations (C)	MAX[ABV]nn[n] MNMn[n]		
			Significant directional variations (C)	VRB BTN nnn/ AND nnn/	—	
6	Visibility (M)	Name of the element (M)	VIS		C A V O K	
		Runway (O)	RWY nn[L] or RWY nn[C] or RWY nn[R]			
		Runway section (O)	TDZ			
		Visibility (M)	n[n][n][n]M or n[n]KM			
		Runway section (O)	MID			
		Visibility (O)	n[n][n][n]M or n[n]KM			
		Runway section (O)	END			
		Visibility (O)	n[n][n][n]M or n[n]KM			
7	Runway visual range (C) ⁽¹⁾	Name of the element (M)	RVR			
		Runway (C)	RWY nn[L] or RWY nn[C] or RWY nn[R]			
		Runway section (C)	TDZ			
		Runway visual range (M)	[ABV or BLW] nn[n][n]M			
		Runway section (C)	MID			
		Runway visual range (C)	[ABV or BLW] nn[n][n]M			
		Runway section (C)	END			
		Runway visual range (C)	[ABV or BLW] nn[n][n]M			
8	Present weather (C)	Intensity of present weather (C)	FBL or MOD or HVY	—		

		Characteristics and type of present weather (C)	DZ or RA or SN or SG or PL or DS or SS or FZDZ or FZUP ⁽²⁾ or FC or FZRA or SHGR or SHGS or SHRA or SHSN or SHUP ⁽²⁾ or TSGR or TSGS or TSRA or TSSN or TSUP ⁽²⁾ or UP ⁽²⁾	FG or BR or SA or DU or HZ or FU or VA or SQ or PO or TS or BCFG or BLDU or BLSA or BLSN or DRDU or DRSA or DRSN or FZFG or MIFG or PRFG or // ⁽²⁾		
9	Cloud (M)	Name of the element (M)	CLD			
		Runway (O)	RWY nn[L] or RWY nn[C] or RWY nn[R]			
		Cloud amount (M) or vertical visibility (O)	FEW or SCT or BKN or OVC or /// ⁽²⁾	OBSC	NSC or NCD ⁽²⁾	
		Cloud type (C)	CB or TCU or /// ⁽²⁾	—		
		Height of cloud base or the value of vertical visibility (C)	n[n][n][n][n]FT or ///FT ⁽²⁾	VER VIS n[n][n][n]FT or VER VIS ///FT ⁽²⁾		
10	Air temperature (M)	Name of the element (M)	T			
		Air temperature (M)	[MS]nn			
11	Dew-point temperature (M)	Name of the element (M)	DP			
		Dew-point temperature (M)	[MS]nn			
12	Pressure values (M)	Name of the element (M)	QNH			
		QNH (M)	nnnnHPA			
		Name of the element (O)	QFE			
		QFE (O)	[RWY nn[L] or RWY nn[C] or RWY nn[R]] nnnnHPA [RWY nn[L] or RWY nn[C] or RWY nn[R]] nnnnHPA			
13	Supplementary information (C)	Significant meteorological phenomena (C)	CB or TS or MOD TURB or SEV TURB or WS or GR or SEV SQL or MOD ICE or SEV ICE or FZDZ or FZRA or SEV MTW or SS or DS or BLSN or FC			
		Location of the phenomena (C)	IN APCH [n][n][n][n]FT-WIND nnn/n[n]KT or IN CLIMB-OUT [n][n][n][n]FT-WIND nnn/n[n]KT or RWY nn[L] or RWY nn[C] or RWY nn[R]			
		Recent weather (C)	REFZDZ or REFZRA or REDZ or RE[SH]RA or RERASN or RE[SH]SN or RESG or RESHGR or RESHGS or REBLSN or RESS or REDS or RETSRA or RETSSN or RETSGR or RETSGS or REFC or REPL or REUP ⁽²⁾ or REFZUP ⁽²⁾ or RETSUP ⁽²⁾ or RESHUP ⁽²⁾ or REVA or RETS			
14	Trend forecast (O)	Name of the element (M)	TREND			
		Change indicator (M)	NOSIG	BECMG or TEMPO		

	Period of change (C)	FMnnnn and/or TLnnnn or ATnnnn			C A V O K
	Wind (C)	nnn/[ABV]n[n]KT [MAX[ABV]nn]			
	Visibility (C)	VIS n[n][n][n]M or VIS n[n]KM			
	Weather phenomenon: intensity (C)	FBL or MOD or HVY	—	NSW	
	Weather phenomenon: characteristics and type (C)	DZ or RA or SN or SG or PL or DS or SS or FZDZ or FZRA or SHGR or SHGS or SHRA or SHSN or TSGR or TSGS or TSRA or TSSN	FG or BR or SA or DU or HZ or FU or VA or SQ Or PO or FC or TS or BCFG or BLDU or BLSA or BLSN or DRDU or DRSA or DRSN or FZFG or MIFG or PRFG		
	Name of the element (C)	CLD			
	Cloud amount and vertical visibility (C)	FEW or SCT or BKN or OVC	OBSC	NSC	
	Cloud type (C)	CB or TCU	—		
	Height of cloud base or the value of vertical visibility (C)	n[n][n][n][n]F T	VER VIS n[n][n][n]FT		

1. To be included if the visibility or the runway visual range is < 1 500 m.

2. For automated reports only.

GM1 MET.TR.200(a) Meteorological reports and other information

ED Decision 2022/004/R

RANGES AND RESOLUTIONS — LOCAL ROUTINE REPORT AND LOCAL SPECIAL REPORT

- (a) The ranges and resolutions for the numerical elements included in the local routine report and local special report are shown below.

Ranges and resolutions for the numerical elements included in local routine reports and local special reports
Note: The row numbers in the 'Ref.' column are included only for clarity and ease of reference, and are not part of the template.

Ref.	Elements included in the local routine report and the local special report	Range	Resolution
1	Runway: (no units)	01–36	1
2	Wind direction: ° true	010–360	10
3	Wind speed: KT	1–99 P99	1 N/A (100 and greater)
4	Visibility: M M KM KM	0–750 800–4 900 5–9 10 or greater	50 100 1 0 (fixed value: 10 KM)
5	Runway visual range: M M M	0–375 400–750 800–2000	25 50 100
6	Vertical visibility: FT FT	0–250 ⁽¹⁾ 300–2 000	50 100
7	Clouds: height of cloud base: FT FT FT	0–250 ⁽¹⁾ 300–9 900 10 000–20 000	50 100 1 000
8	Air temperature; Dew-point temperature: °C	– 80 to + 60	1
9	QNH; QFE: hPa	0500–1 100	1

⁽¹⁾ Under certain circumstances, as specified in AMC1 MET.TR.205(e)(3); otherwise, a resolution of 100 ft is to be used.

- (b) The explanations for the abbreviations can be found in ICAO Doc 8400 'Procedures for Air Navigation Services — ICAO Abbreviations and Codes (PANS-ABC)'.

GM2 MET.TR.200(a) Meteorological reports and other information

ED Decision 2022/004/R

LOCAL ROUTINE REPORT AND LOCAL SPECIAL REPORT — EXAMPLES OF ELEMENTS

Non-exhaustive examples of the different elements used in the formulation of local routine reports and local special reports are provided below.

Local routine report and local special report — Examples of elements		
<p><i>Note 1:</i> Consult the ‘local routine report’ and the ‘local special report’ template in AMC1 MET.TR.200(a) to identify the mandatory (M), the conditional (C) or the optional (O) elements.</p> <p><i>Note 2:</i> The ranges and resolutions for the numerical elements included in local routine reports and local special reports are provided in GM1 MET.TR.200(a).</p> <p><i>Note 3:</i> The row numbers in the ‘Ref.’ column are included only for clarity and ease of reference, and are not part of the report. They do not correlate with the ‘Ref.’ column in AMC1 MET.TR.200(a). Refer to the ‘Element’ column when cross-referencing.</p>		
Ref.	Element	Examples
1	Identification of the type of report	MET REPORT SPECIAL
2	Location indicator	YUDO
3	Time of the observation	221630Z
4	Identification of an automated report	AUTO
5	Surface wind	WIND 240/8KT WIND RWY 18 TDZ 190/12KT WIND VRB2KT WIND CALM WIND VRB BTN 350/ AND 050/2KT WIND 270/ABV99KT WIND 120/6KT MAX18 MNM4 WIND 020/10KT VRB BTN 350/ AND 070/ WIND RWY 14R MID 140/12KT WIND RWY 27 TDZ 240/16KT MAX28 MNM10 END 250/14KT
6	Visibility	VIS 350M CAVOK VIS 7KM VIS 10KM VIS RWY 09 TDZ 800M END 1200M VIS RWY 18C TDZ 6KM RWY 27 TDZ 4000M

7	Runway visual range	RVR RWY 32 400M RVR RWY 20 1600M RVR RWY 10L BLW 50M RVR RWY 14 ABV 2000M RVR RWY 12 TDZ 1100M MID ABV 2000M RVR RWY 16 TDZ 600M MID 500M END 400M RVR RWY 26 500M RWY 20 800M
8	Present weather	MOD RA HVY TSRA HVY DZ FBL SN HZ FG VA MIFG HVY TSRASN FBL SNRA FBL DZ FG HVY SHSN BLSN HVY TSUP //
9	Cloud	CLD NSC CLD SCT 1000FT OVC 2000FT CLD OBSC VER VIS 500FT CLD BKN TCU 900FT CLD RWY 08R BKN 200FT RWY 26 BKN 300FT CLD /// CB ///FT CLD /// CB 1200FT CLD NCD
10	Air temperature	T17 TMS08
11	Dew-point temperature	DP15 DPMS18
12	Pressure values	QNH 0995HPA QNH 1009HPA QNH 1022HPA QFE 1001HPA QNH 0987HPA QFE RWY 18 0956HPA RWY 24 0955HPA
13	Supplementary information	FC IN APCH WS IN APCH 180FT-WIND 360/26KT WS RWY 12 REFZRA CB IN CLIMB-OUT RETSRA

14	Trend forecast	TREND NOSIG TREND BECMG FEW 2000FT TREND TEMPO 250/36KT MAX50 TREND BECMG AT1800 VIS 10KM NSW TREND BECMG TL1700 VIS 800M FG TREND BECMG FM1030 TL1130 CAVOK TREND TEMPO TL1200 VIS 600M BECMG AT1230 VIS 8KM NSW CLD NSC TREND TEMPO FM0300 TL0430 MOD FZRA TREND BECMG FM1900 VIS 500M HVY SNRA TREND BECMG FM1100 MOD SN TEMPO FM1130 BLSN TREND BECMG AT1130 CLD OVC 1000FT TREND TEMPO TL1530 HVY SHRA CLD BKN CB 1200FT
----	----------------	--

GM1 MET.TR.200(a)(2) Meteorological reports and other information

ED Decision 2022/004/R

LOCATION INDICATORS

The location indicators and their significations are published in ICAO Doc 7910 'Location Indicators'.

AMC1 MET.TR.200(a)(4) Meteorological reports and other information

ED Decision 2022/004/R

AUTOMATED REPORTING

Local routine report, local special report, METAR and SPECI from automatic observing systems should be identified with the word 'AUTO'.

GM1 MET.TR.200(a)(4) Meteorological reports and other information

ED Decision 2022/004/R

AUTOMATED REPORTING

Local routine report, local special report, METAR and SPECI from automatic observing systems may be used as agreed between the aeronautical meteorological stations and the users.

AMC1 MET.TR.200(a)(12) Meteorological reports and other information

ED Decision 2022/004/R

SUPPLEMENTARY INFORMATION — SEMI-AUTOMATIC OBSERVING SYSTEM

- (a) In local routine report, local special report, METAR and SPECI, when reported by a semi-automatic observing system, the following recent weather phenomena should be reported, up to a maximum of three groups, in the supplementary information:
- (1) freezing precipitation;
 - (2) moderate or heavy precipitation, including showers thereof;
 - (3) blowing snow;
 - (4) dust storm, sandstorm;
 - (5) thunderstorm;
 - (6) funnel cloud, tornado or water spout; and
 - (7) volcanic ash.
- (b) In local routine report and local special report when reported by a semi-automatic observing system, the following significant meteorological conditions, or combinations thereof, should be reported in the supplementary information:
- (1) cumulonimbus clouds (CB);
 - (2) thunderstorm (TS);
 - (3) moderate or severe turbulence (MOD TURB, SEV TURB);
 - (4) wind shear (WS);
 - (5) hail (GR);
 - (6) severe squall line (SEV SQL);
 - (7) moderate or severe icing (MOD ICE, SEV ICE);
 - (8) freezing precipitation (FZDZ, FZRA);
 - (9) severe mountain waves (SEV MTW);
 - (10) dust storm, sandstorm (DS, SS);
 - (11) blowing snow (BLSN); and
 - (12) funnel cloud (tornado or water spout) (FC).

The location of the condition should be indicated. Where necessary, additional information should be included using abbreviated plain language.

AMC2 MET.TR.200(a)(12) Meteorological reports and other information

ED Decision 2022/004/R

SUPPLEMENTARY INFORMATION — AUTOMATIC OBSERVING SYSTEM

In local routine report, local special report, METAR and SPECI, when reported by an automatic observing system, the following recent weather phenomena should be reported, up to a maximum of three groups, in the supplementary information:

- (a) FZDZ, FZRA and FZUP;
- (b) moderate or heavy DZ, RA and SN;
- (c) thunderstorm; and
- (d) moderate or heavy unknown precipitation (UP).

AMC3 MET.TR.200(a)(12) Meteorological reports and other information

ED Decision 2022/004/R

SUPPLEMENTARY INFORMATION — WIND SHEAR

Information on wind shear should be included as supplementary information in local routine report, local special report, METAR and SPECI, where local circumstances so warrant.

AMC4 MET.TR.200(a)(12) Meteorological reports and other information

ED Decision 2022/004/R

SUPPLEMENTARY INFORMATION — SEA-SURFACE TEMPERATURE AND STATE OF THE SEA

In METAR and SPECI, information on sea-surface temperature and the state of the sea or the significant wave height, from aeronautical meteorological stations established on offshore structures in support of helicopter operations, should be included in the supplementary information.

AMC5 MET.TR.200(a)(12) Meteorological reports and other information

ED Decision 2017/001/R

SUPPLEMENTARY INFORMATION — SIGNIFICANT METEOROLOGICAL CONDITIONS

- (a) Observations made at aerodromes should include the available supplementary information concerning significant meteorological conditions, particularly those in the approach and climb-out areas.
- (b) Where practicable, the information should identify the location of the meteorological condition.

GM1 MET.TR.200(a)(12) Meteorological reports and other information

ED Decision 2022/004/R

SUPPLEMENTARY INFORMATION — RECENT WEATHER PHENOMENA

‘Recent weather phenomena’ is understood as being the weather phenomena observed at the aerodrome during the period since the last issued routine report or last hour, whichever is the shorter, but not at the time of observation.

GM2 MET.TR.200(a)(12) Meteorological reports and other information

ED Decision 2022/004/R

SUPPLEMENTARY INFORMATION — LOCAL CIRCUMSTANCES

Local circumstances include but are not necessarily limited to wind shear of non-transitory nature such as might be associated with low-level temperature inversions or local topography.

GM3 MET.TR.200(a)(12) Meteorological reports and other information

ED Decision 2022/004/R

SUPPLEMENTARY INFORMATION — WIND SHEAR

The inclusion of wind shear in the supplementary information is understood to be addressed, as a minimum, in local routine report, local special report, METAR and SPECI when reported by a semi-automatic observing system.

GM1 MET.TR.200(b) & (c) Meteorological reports and other information

ED Decision 2022/004/R

EXAMPLE OF METAR AND LOCAL ROUTINE REPORT

- (a) Local routine report (same location and weather conditions as METAR):
MET REPORT YUDO 221630Z WIND 240/4KT VIS 600M RVR RWY 12 TDZ 1000M MOD DZ FG CLD SCT 1000FT OVC 2000FT T17 DP16 QNH 1018HPA TREND BECMG TL1700 VIS 800M FG BECMG AT1800 VIS 10KM NSW
- (b) METAR for YUDO (Donlon/International)*:
METAR YUDO 221630Z 24004KT 0600 R12/1000U DZ FG SCT010 OVC020 17/16 Q1018 BECMG TL1700 0800 FG BECMG AT 1800 9999 NSW

Meaning of both reports:

Routine report for Donlon/International* issued on the 22nd of the month at 16.30 UTC; surface wind direction 240 degrees; wind speed 4 knots; visibility (along the runway(s) in the local routine report; prevailing visibility in METAR) 600 metres; runway visual range representative of the touchdown zone for runway 12 is 1 000 metres and the runway visual range values have shown an upward tendency during previous 10 minutes (runway visual range tendency to be included in METAR only); and moderate drizzle and fog; scattered cloud at 1 000 feet; overcast at 2 000 feet; air temperature 17 degrees Celsius; dew-point

temperature 16 degrees Celsius; QNH 1 018 hectopascals; TREND during next 2 hours; visibility (along the runway(s) in the local routine report; prevailing visibility in METAR) becoming 800 metres in fog by 17.00 UTC; at 18.00 UTC visibility (along the runway(s) in the local routine report; prevailing visibility in METAR) becoming 10 kilometres or more and nil significant weather.

* Fictitious location

GM1 MET.TR.200(b) Meteorological reports and other information

ED Decision 2022/004/R

EXAMPLE OF SPECI AND LOCAL SPECIAL REPORT

(a) Local special report (same location and weather conditions as SPECI):

SPECIAL YUDO 151115Z WIND 050/25KT MAX37 MNM10 VIS 1200M RVR RWY 05 ABV 1800M HVY TSRA CLD BKN CB 500FT T25 DP22 QNH 1008HPA TREND TEMPO TL1200 VIS 600M BECMG AT1200 VIS 8KM NSW NSC

(b) SPECI for YUDO (Donlon/International)*:

SPECI YUDO 151115Z 05025G37KT 3000 1200NE+TSRA BKN005CB 25/22 Q1008 TEMPO TL1200 0600 BECMG AT1200 8000 NSW NSC

Meaning of both reports:

Special report for Donlon/International* issued on the 15th of the month at 11.15 UTC; surface wind direction 050 degrees; wind speed 25 knots gusting between 10 and 37 knots (minimum wind speed not to be included in SPECI); visibility 1 200 metres (along the runway(s) in the local special report); prevailing visibility 3 000 metres (in SPECI) with minimum visibility 1 200 metres to north east (directional variations to be included in SPECI only); Runway visual range above 1 800 metres on runway 05 (runway visual range not required in SPECI with prevailing visibility of 3 000 metres); thunderstorm with heavy rain; broken cumulonimbus cloud at 500 feet; air temperature 25 degrees Celsius; dew-point temperature 22 degrees Celsius; QNH 1 008 hectopascals; trend during next 2 hours; visibility (along the runway(s) in the local special report; prevailing visibility in SPECI) temporarily 600 metres from 11.15 to 12.00, becoming at 12.00 UTC visibility (along the runway(s) in the local special report; prevailing visibility in SPECI) 8 kilometres, thunderstorm ceases and nil significant weather and nil significant cloud.

* Fictitious location

AMC1 MET.TR.200(c) Meteorological reports and other information

ED Decision 2022/004/R

METAR AND SPECI — CODE FORM

METAR and SPECI, and corrections thereto, should be encoded using:

- (a) the IWXXM GML form as specified in point (a) of [AMC1 MET.TR.115\(a\)](#); and
- (b) the alphanumeric code form for METAR as specified in point (b) of [AMC1 MET.TR.115\(a\)](#).

GM1 MET.TR.200(e)(5) Meteorological reports and other information

ED Decision 2020/008/R

NOISE ABATEMENT PROCEDURES

Noise abatement procedures are those in accordance with 7.2.6 of ICAO Doc 4444 'Procedures for Air Navigation Services (PANS-ATM)' as last amended.

GM1 MET.TR.200(f) Meteorological reports and other information

ED Decision 2022/004/R

ISSUANCE OF LOCAL SPECIAL REPORTS

Point (f) of [MET.TR.200](#) relates to the list of criteria to provide local special reports and SPECI when a meteorological change occurs. The agreement between the meteorological service provider and the competent authority is introduced as these criteria are usually agreed with the competent authority. Also, in introducing this agreement, the nature of the transposed provision (Appendix 3, 2.3.3 Recommendation) of ICAO Annex 3 remains.

AMC1 MET.TR.200(f)(8) Meteorological reports and other information

ED Decision 2022/004/R

ISSUANCE OF SPECI

Other criteria based on local aerodrome operating minima are to be considered in accordance with point (j) of [AMC1 MET.TR.220\(f\)](#).

MET.TR.205 Reporting of meteorological elements

Regulation (EU) 2021/1338

- (a) Surface wind direction and speed
 - (1) In local routine report, local special report, METAR and SPECI, the surface wind direction and speed shall be reported in steps of 10 degrees true and 1 kt respectively.
 - (2) Any observed value that does not fit the reporting scale in use shall be rounded to the nearest step in the scale.
 - (3) In local routine report, local special report, METAR and SPECI:
 - (i) the units of measurement used for the wind speed shall be indicated;
 - (ii) variations from the mean wind direction during the past 10 minutes shall be reported as follows, if the total variation is 60° or more, alternatively:
 - (A) when the total variation is 60° or more and less than 180° and the wind speed is 3 kt or more, such directional variations shall be reported as the two extreme directions between which the surface wind has varied;
 - (B) when the total variation is 60° or more and less than 180° and the wind speed is less than 3 kt, the wind direction shall be reported as variable with no mean wind direction;

- (C) when the total variation is 180° or more, the wind direction shall be reported as variable with no mean wind direction;
 - (iii) variations from the mean wind speed (gusts), during the past 10 minutes shall be reported when the maximum wind speed exceeds the mean speed by, alternatively:
 - (A) 5 kt or more in local routine report and local special report when noise abatement procedures are applied;
 - (B) 10 kt or more otherwise;
 - (iv) when a wind speed of less than 1 kt is reported, it shall be indicated as calm;
 - (v) when a wind speed of 100 kt or more is reported, it shall be indicated to be more than 99 kt;
 - (vi) when variations from the mean wind speed (gusts) are reported in accordance with point MET.TR.205(a), the maximum value of the wind speed attained shall be reported;
 - (vii) when the 10-minute period includes a marked discontinuity in the wind direction and/or speed, only variations from the mean wind direction and mean wind speed occurring since the discontinuity shall be reported.
- (b) Visibility
- (1) In local routine report, local special report, METAR and SPECI, the visibility shall be reported in steps of 50 m when the visibility is less than 800 m; in steps of 100 m when it is 800 m or more, but less than 5 km; in kilometre steps when the visibility is 5 km or more, but less than 10 km; and it shall be given as 10 km when the visibility is 10 km or more, except when the conditions for the use of CAVOK apply.
 - (2) Any observed value which does not fit the reporting scale in use shall be rounded down to the nearest lower step in the scale.
 - (3) In local routine report and local special report, visibility along the runway or runways shall be reported together with the units of measurement used to indicate visibility.
- (c) Runway visual range (RVR)
- (1) In local routine report, local special report, METAR and SPECI, the RVR shall be:
 - (i) reported throughout periods when either the visibility or the runway visual range is less than 1 500 m;
 - (ii) reported in steps of 25 m when it is less than 400 m, in steps of 50 m when it is between 400 and 800 m, and in steps of 100 m when it is more than 800 m.
 - (2) Any observed value which does not fit the reporting scale in use shall be rounded down to the nearest lower step in the scale.
 - (3) In local routine report, local special report, METAR and SPECI:
 - (i) when the RVR is above the maximum value that can be determined by the system in use, it shall be reported using the abbreviation 'ABV' in local routine report and local special report, and the abbreviation 'P' in METAR and SPECI followed by the maximum value that can be determined by the system;

- (ii) when the RVR is below the minimum value that can be determined by the system in use, it shall be reported using the abbreviation ‘BLW’ in local routine report and local special report, and the abbreviation ‘M’ in METAR and SPECI, followed by the minimum value that can be determined by the system.
- (4) In local routine report and local special report:
- (i) the units of measurement used shall be included;
 - (ii) if the RVR is observed from only one location along the runway, such as the touchdown zone, it shall be included without any indication of location;
 - (iii) if the RVR is observed from more than one location along the runway, the value representative of the touchdown zone shall be reported first, followed by the values representative of the mid-point and stop-end, and the locations for which these values are representative shall be indicated;
 - (iv) when there is more than one runway in use, the available RVR values for each runway shall be reported, and the runways to which the values refer shall be indicated.
- (d) Present weather phenomena
- (1) In local routine report and local special report, observed present weather phenomena shall be reported in terms of type and characteristics and qualified with respect to intensity, as appropriate.
 - (2) In METAR and SPECI, observed present weather phenomena shall be reported in terms of type and characteristics and qualified with respect to intensity or proximity to the aerodrome, as appropriate.
 - (3) In local routine report, local special report, METAR and SPECI, the following characteristics of present weather phenomena, as necessary, shall be reported using their respective abbreviations and relevant criteria, as appropriate:
 - (i) **Thunderstorm (TS)**
Used to report a thunderstorm with precipitation. When thunder is heard or lightning is detected at the aerodrome during the 10-minute period preceding the time of observation but no precipitation is observed at the aerodrome, the abbreviation ‘TS’ shall be used without qualification.
 - (ii) **Freezing (FZ)**
Supercooled water droplets or precipitation, used with types of present weather phenomena in accordance with [Appendix 1](#).
 - (4) In local routine report, local special report, METAR and SPECI:
 - (i) one or more, up to a maximum of three, of the present weather abbreviations shall be used, as necessary, together with an indication, where appropriate, of the characteristics and intensity or proximity to the aerodrome, so as to convey a complete description of the present weather of significance to flight operations;
 - (ii) the indication of intensity or proximity, as appropriate, shall be reported first followed respectively by the characteristics and the type of weather phenomena;
 - (iii) where two different types of weather are observed, they shall be reported in two separate groups, where the intensity or proximity indicator refers to the weather

phenomenon which follows the indicator. However, different types of precipitation occurring at the time of observation shall be reported as one single group with the dominant type of precipitation reported first and preceded by only one intensity qualifier which refers to the intensity of the total precipitation.

(e) Clouds

- (1) In local routine report, local special report, METAR and SPECI, the height of cloud base shall be reported in steps of 100 ft up to 10 000 ft and in steps of 1 000 ft above 10 000 ft.
- (2) Any observed value which does not fit the reporting scale in use shall be rounded down to the nearest lower step in the scale.
- (3) In local routine report and local special report:
 - (i) the units of measurement used for the height of cloud base and vertical visibility shall be indicated;
 - (ii) when there is more than one runway in use and the heights of cloud bases are observed by instruments for these runways, the available heights of cloud bases for each runway shall be reported, and the runways to which the values refer shall be indicated.

(f) Air temperature and dew-point temperature

- (1) In local routine report, local special report, METAR and SPECI, the air temperature and the dew-point temperature shall be reported in steps of whole degrees Celsius.
- (2) Any observed value which does not fit the reporting scale in use shall be rounded to the nearest whole degree Celsius, with observed values involving 0,5° rounded up to the next higher whole degree Celsius.
- (3) In local routine report, local special report, METAR and SPECI, a temperature below 0 °C shall be identified.

(g) Atmospheric pressure

- (1) In local routine report, local special report, METAR and SPECI, the QNH and QFE shall be computed in tenths of hectopascals and reported therein in steps of whole hectopascals, using four digits.
- (2) Any observed value which does not fit the reporting scale in use shall be rounded down to the nearest lower whole hectopascal.
- (3) In local routine report and local special report:
 - (i) QNH shall be included;
 - (ii) QFE shall be included if required by users or, if so agreed locally between the provider of meteorological services, the ATS unit and the operators concerned, on a regular basis;
 - (iii) the units of measurement used for QNH and QFE values shall be included;
 - (iv) if QFE values are required for more than one runway, the required QFE values for each runway shall be reported, and the runway(s) to which the values refer shall be indicated.
- (4) In METAR and SPECI, only QNH values shall be included.

GM1 MET.TR.205(a)(3)(iii)(A) Reporting of meteorological elements

ED Decision 2020/008/R

NOISE ABATEMENT PROCEDURES

The noise abatement procedures are those in accordance with 7.2.6 of ICAO Doc 4444 'Procedures for Air Navigation Services (PANS-ATM)'.

AMC1 MET.TR.205(b)(1) Reporting of meteorological elements

ED Decision 2022/004/R

VISIBILITY

In METAR and SPECI, visibility should be reported as prevailing visibility. When the visibility is not the same in different directions and:

- (a) when the lowest visibility is different from the prevailing visibility, and (1) less than 1 500 m or (2) less than 50 % of the prevailing visibility, and less than 5 000 m, the lowest visibility observed should also be reported and, when possible, its general direction in relation to the aerodrome reference point indicated by reference to one of the eight points of the compass;
- (b) if the lowest visibility is observed in more than one direction, then the most operationally significant direction should be reported; and
- (c) when the visibility is fluctuating rapidly, and the prevailing visibility cannot be determined, only the lowest visibility should be reported, with no indication of direction.

AMC1 MET.TR.205(b)(3) Reporting of meteorological elements

ED Decision 2022/004/R

VISIBILITY — VALUES

In local routine report and local special report, when instrumented systems are used for the measurement of visibility:

- (a) if the visibility is observed from more than one location along the runway, the values representative of the touchdown zone should be reported first, followed, as necessary, by the values representative of the mid-point and stop-end of the runway, and the locations for which these values are representative should be indicated; and
- (b) when there is more than one runway in use and the visibility is observed related to these runways, the available visibility values for each runway should be reported, and the runways to which the values refer should be indicated.

AMC1 MET.TR.205(c) Reporting of meteorological elements

ED Decision 2022/004/R

RUNWAY VISUAL RANGE (RVR) — TOUCHDOWN ZONE VALUES

In METAR and SPECI:

- (a) only the value representative of the touchdown zone should be reported and no indication of location on the runway should be included; and

- (b) where there is more than one runway available for landing, touchdown zone RVR values should be included for all such runways, up to a maximum of four, and the runways to which the values refer should be indicated.

AMC1 MET.TR.205(c)(1) Reporting of meteorological elements

ED Decision 2022/004/R

RUNWAY VISUAL RANGE (RVR) — THRESHOLD LIMITS

- (a) 50 m should be considered the lower limit, and 2 000 m the upper limit for RVR.
- (b) Beyond these limits, local routine report, local special report, METAR and SPECI should merely indicate that the RVR is less than 50 or more than 2 000 m.

AMC1 MET.TR.205(c)(3) Reporting of meteorological elements

ED Decision 2022/004/R

RUNWAY VISUAL RANGE (RVR) — VALUES FOR METAR AND SPECI

- (a) When instrumented systems are used for the assessment of RVR, the variations in RVR during the 10-minute period immediately preceding the observation should be included if the RVR values during the 10-minute period have shown a distinct tendency, such that the mean during the first 5 minutes varies by 100 m or more from the mean during the second 5 minutes of the period.
- (b) When the variation of the RVR values shows an upward or downward tendency, this should be indicated by the abbreviation 'U' or 'D', respectively. In cases when actual fluctuations during the 10-minute period show no distinct tendency, this should be indicated using the abbreviation 'N'.
- (c) When indications of tendency are not available, no abbreviations should be included.

AMC1 MET.TR.205(c)(4)(iii) Reporting of meteorological elements

ED Decision 2017/001/R

RUNWAY VISUAL RANGE (RVR) — VALUES REPRESENTATION

- (a) RVR assessments should be representative of:
- (1) the touchdown zone of the runway intended for Category I instrument approach and landing operations;
 - (2) the touchdown zone and the mid-point of the runway intended for Category II instrument approach and landing operations; and
 - (3) the touchdown zone, mid-point and stop-end of the runway intended for Category III instrument approach and landing operations.
- (b) Where RVR is determined by human observers, it should be reported to the appropriate local ATS units, whenever there is a change in the value to be reported in accordance with the reporting scale.
- (c) The transmission of such reports should normally be completed within 15 seconds after the termination of the observation.

AMC1 MET.TR.205(d) Reporting of meteorological elements

ED Decision 2022/004/R

PRESENT WEATHER PHENOMENA — AUTOMATIC OBSERVING SYSTEM

In local routine report, local special report, METAR and SPECI reported by an automatic observing system, the following types of present weather phenomena should be reported, using their respective abbreviations and relevant criteria, as appropriate:

- (a) Precipitation:
 - (1) drizzle (DZ);
 - (2) rain (RA);
 - (3) snow (SN); and
 - (4) Unidentified precipitation (UP)
- (b) Obscurations (hydrometeors);
 - (1) Fog (FG): reported when visibility is less than 1 000 m ;
 - (2) Mist (BR): reported when visibility is at least 1 000 m, but not more than 5 000 m;
- (c) Obscurations (lithometeors). Haze (HZ) should be used when the obscuration consists predominantly of lithometeors and the visibility is 5 000 m or less; and
- (d) Temporary failure of system/sensor: the present weather should be replaced by ‘//’ when it cannot be observed due to a temporary failure of the system/sensor.

AMC2 MET.TR.205(d) Reporting of meteorological elements

ED Decision 2022/004/R

PRESENT WEATHER PHENOMENA — SEMI-AUTOMATIC OBSERVING SYSTEM

In local routine report, local special report, METAR and SPECI reported by a semi-automatic observing system, the following types of present weather phenomena should be reported, using their respective abbreviations and relevant criteria, as appropriate:

- (a) Precipitation:
 - (1) drizzle (DZ);
 - (2) rain (RA);
 - (3) snow (SN);
 - (4) snow grains (SG);
 - (5) ice pellets (PL);
 - (6) hail (GR): reported when the diameter of the largest hailstones is 5 mm or more;
 - (7) small hail and/or snow pellets (GS): reported when the diameter of the largest hailstones is less than 5 mm.
- (b) Obscurations (hydrometeors):
 - (1) fog (FG): reported when visibility is less than 1 000 m, except when qualified by ‘MI’, ‘BC’, ‘PR’ or ‘VC’.
 - (2) mist (BR): reported when visibility is at least 1 000 m, but not more than 5 000 m;

(c) Obscurations (lithometeors)

The following should be used only when the obscuration consists predominantly of lithometeors and the visibility is 5 000 m or less, except 'SA' when qualified by 'DR' and volcanic ash:

- (1) sand (SA);
- (2) dust (widespread) (DU);
- (3) haze (HZ);
- (4) smoke (FU); and
- (5) volcanic ash (VA).

(d) Other phenomena:

- (1) dust/sand whirls (dust devils) (PO);
- (2) squall (SQ);
- (3) funnel cloud (tornado or waterspout) (FC);
- (4) dust storm (DS);
- (5) sandstorm (SS).

AMC3 MET.TR.205(d) Reporting of meteorological elements

ED Decision 2022/004/R

PRESENT WEATHER PHENOMENA — UNIDENTIFIED PRECIPITATION (UP)

In automated local routine report, local special report, METAR and SPECI, in addition to drizzle (DZ), rain (RA) and snow (SN), the abbreviation 'UP' should be used for unidentified precipitation when the type of precipitation cannot be identified by the automatic observing system.

AMC1 MET.TR.205(d)(3) Reporting of meteorological elements

ED Decision 2022/004/R

PRESENT WEATHER PHENOMENA — CHARACTERISTICS

- (a) In local routine report, local special report, METAR and SPECI, only when reported by a semi-automatic observing system, the following characteristics of present weather phenomena, as necessary, should be reported using their respective abbreviations and relevant criteria, as appropriate:
- (1) Shower (SH): used to report showers. Showers observed in the vicinity of the aerodrome should be reported as 'VCSH' without qualification regarding type or intensity of precipitation.
 - (2) Blowing (BL): used with types of present weather phenomena raised by the wind to a height of 6 ft (2 m) or more above the ground.
 - (3) Low drifting (DR): used with types of present weather phenomena raised by the wind to less than 6 ft (2 m) above ground level.
 - (4) Shallow (MI): less than 6 ft (2 m) above ground level.
 - (5) Patches (BC): fog patches randomly covering the aerodrome.

- (6) Partial (PR): a substantial part of the aerodrome covered by fog while the remainder is clear.
- (b) In automated local routine report, local special report, METAR and SPECI, when showers (SH) referred to above cannot be determined based upon a method that takes account of the presence of convective cloud, the precipitation should not be characterised by 'SH'.

AMC2 MET.TR.205(d)(3) Reporting of meteorological elements

ED Decision 2022/004/R

PRESENT WEATHER PHENOMENA — INTENSITY

In local routine report, local special report, METAR and SPECI, the relevant intensity or, as appropriate, the proximity to the aerodrome of the reported present weather phenomena should be indicated as follows:

	(local routine reports and local special reports)	(METAR)
Light	FBL	–
Moderate	MOD	(no indication)
Heavy	HVY	+

- Used with types of present weather phenomena. Light intensity should be indicated only for precipitation.

Vicinity (VC)

Between approximately 8 and 16 km of the aerodrome reference point and used only in METAR and SPECI with present weather when not reported under [AMC1 MET.TR.205\(d\)\(3\)](#) and [MET.TR.205\(d\)\(3\)](#).

GM1 MET.TR.205(d)(3)(i) Reporting of meteorological elements

ED Decision 2020/008/R

PRESENT WEATHER PHENOMENA — TS LIGHTNING DETECTION EQUIPMENT

- (a) At aerodromes with human observers, lightning detection equipment may supplement human observations.
- (b) For aerodromes with automatic observing systems, guidance on the use of lightning detection equipment intended for thunderstorm reporting is given in ICAO Doc 9837 'Manual on Automatic Meteorological Observing Systems at Aerodromes'.

AMC1 MET.TR.205(e)(1) Reporting of meteorological elements

ED Decision 2022/004/R

CLOUD

In local routine report, local special report, METAR and SPECI:

- (a) the cloud amount should be reported using the abbreviations 'FEW' (1 to 2 oktas), 'SCT' (3 to 4 oktas), 'BKN' (5 to 7 oktas) or 'OVC' (8 oktas);
- (b) cumulonimbus clouds and towering cumulus clouds should be indicated as 'CB' and 'TCU', respectively;
- (c) the vertical visibility should be reported in steps of 100 ft (30 m) up to 2 000 ft (600 m);

- (d) if there are no clouds of operational significance and no restriction on vertical visibility and the abbreviation 'CAVOK' is not appropriate, the abbreviation 'NSC' should be used;
- (e) when several layers or masses of cloud of operational significance are observed, their amount and height of cloud base should be reported in increasing order of the height of cloud base, and in accordance with the following criteria:
 - (1) the lowest layer or mass, regardless of the amount to be reported as FEW, SCT, BKN or OVC, as appropriate;
 - (2) the next layer or mass, covering more than 2/8 to be reported as SCT, BKN or OVC, as appropriate;
 - (3) the next higher layer or mass, covering more than 4/8 to be reported as BKN or OVC, as appropriate; and
 - (4) cumulonimbus and/or towering cumulus clouds, whenever observed and not reported in (1) to (3).
- (f) when the cloud base is diffuse or ragged or fluctuating rapidly, the minimum height of cloud base or cloud fragments, should be reported; and
- (g) when an individual layer (mass) of cloud is composed of cumulonimbus and towering cumulus clouds with a common cloud base, the type of cloud should be reported as cumulonimbus only.

AMC2 MET.TR.205(e)(1) Reporting of meteorological elements

ED Decision 2022/004/R

CLOUD — AUTOMATIC OBSERVING SYSTEM

When an automatic observing system is used to report local routine report, local special report, METAR and SPECI:

- (a) when the cloud type cannot be observed, the cloud type in each cloud group should be replaced by '///';
- (b) when no clouds are detected, it should be indicated by using the abbreviation 'NCD';
- (c) when cumulonimbus clouds or towering cumulus clouds are detected and the cloud amount and/or the height of cloud base cannot be observed, the cloud amount and/or the height of cloud base should be replaced by '///'; and
- (d) when the sky is obscured and the value of the vertical visibility cannot be determined due to a temporary failure of the system/sensor, the vertical visibility should be replaced by '///'.

AMC1 MET.TR.205(e)(3) Reporting of meteorological elements

ED Decision 2022/004/R

CLOUD — HEIGHT OF CLOUD BASE

At aerodromes where low-visibility procedures are established for approach and landing, as agreed between the aeronautical meteorological station and the appropriate ATS unit, in local routine report and local special report, the height of cloud base should be reported in steps of 50 ft up to and including 300 ft and in steps of 100 ft between 300 ft and 10 000 ft, and the vertical visibility in steps of 50 ft up to and including 300 ft and in steps of 100 ft between 300 ft and 2 000 ft.

MET.TR.210 Observing meteorological elements

Regulation (EU) 2021/1338

The following meteorological elements shall be observed and/or measured with specified accuracy and disseminated by automatic or semi-automatic meteorological observing system.

(a) Surface wind direction and speed

The mean direction and the mean speed of the surface wind shall be measured, as well as significant variations of the wind direction and speed (gusts), and reported in degrees true and knots, respectively.

(1) Siting

The meteorological instrument used to measure surface wind direction and speed shall be situated in such a way as to provide data which is representative of the area for which the measurements are required.

(2) Display

Surface wind displays relating to each sensor shall be located in the aeronautical meteorological station. The displays in the aeronautical meteorological station and in the air traffic services units shall relate to the same sensors, and where separate sensors are required, the displays shall be clearly marked to identify the runway and section of runway monitored by each sensor.

(3) Averaging

The averaging period for surface wind observations shall be:

- (i) 2 minutes for local routine report and local special report and for wind displays in ATS units;
- (ii) 10 minutes for METAR and SPECI, except that when the 10-minute period includes a marked discontinuity in the wind direction and/or speed; only data occurring after the discontinuity shall be used for obtaining mean values; hence, the time interval in these circumstances shall be correspondingly reduced.

(b) Visibility

(1) The visibility shall be measured or observed, and reported in metres or kilometres.

(2) Siting

The meteorological instrument used to measure visibility shall be situated in such a way as to supply data which is representative of the area for which the measurements are required.

(3) Displays

When instrumented systems are used for the measurement of visibility, visibility displays relating to each sensor shall be located in the aeronautical meteorological station. The displays in the aeronautical meteorological station and in the air traffic services units shall relate to the same sensors, and where separate sensors are required, the displays shall be clearly marked to identify the area monitored by each sensor.

(4) Averaging

The averaging period shall be 10 minutes for METAR, except that when the 10-minute period immediately preceding the observation includes a marked discontinuity in the

visibility, only those values occurring after the discontinuity shall be used for obtaining mean values.

(c) Runway visual range (RVR)

(1) The RVR shall be reported in metres.

(2) Siting

The meteorological instrument used to assess the RVR shall be situated in such a way as to provide data which is representative of the area for which the observations are required.

(3) Instrumented systems

Instrumented systems based on transmissometers or forward-scatter meters shall be used to assess RVR on runways intended for Category II and III instrument approach and landing operations, and for Category I instrument approach and landing operations as determined by the competent authority.

(4) Display

Where the RVR is determined by instrumented systems, one display or more, if required, shall be located in the aeronautical meteorological station. The displays in the aeronautical meteorological station and in the ATS units shall relate to the same sensors, and where separate sensors are required, the displays shall be clearly marked to identify the runway and section of the runway monitored by each sensor.

(5) Averaging

(i) Where instrumented systems are used for the assessment of the RVR, their output shall be updated at least every 60 seconds to permit the provision of current, representative values.

(ii) The averaging period for RVR values shall be:

(A) 1 minute for local routine report and local special report and for RVR displays in ATS units;

(B) 10 minutes for METAR and SPECI, except that when the 10-minute period immediately preceding the observation includes a marked discontinuity in RVR values; then only those values occurring after the discontinuity shall be used for obtaining mean values.

(d) Present weather phenomena

(1) The following present weather phenomena shall be reported, as a minimum: rain, drizzle, snow and freezing precipitation, including intensity thereof, haze, mist, fog, freezing fog and thunderstorms, including thunderstorms in the vicinity.

(2) Siting

The meteorological instrument used to measure present weather at the aerodrome and its vicinity shall be situated in such a way as to provide data which is representative of the area for which the measurements are required.

(e) Clouds

(1) Cloud amount, cloud type and height of cloud base shall be observed and reported as necessary to describe the clouds of operational significance. When the sky is obscured,

vertical visibility shall be observed and reported, where measured, instead of cloud amount, cloud type and height of cloud base. The height of cloud base and vertical visibility shall be reported in feet.

(2) Siting

The meteorological instrument used to measure clouds amount and height shall be situated in such a way as to provide data which is representative of the area for which the measurements are required.

(3) Display

When automated equipment is used for the measurement of the height of cloud base, at least one display shall be located in the aeronautical meteorological station. The displays in the aeronautical meteorological station and in the air traffic services units shall relate to the same sensors, and where separate sensors are required, the displays shall be clearly marked to identify the area monitored by each sensor.

(4) Reference level

- (i) The height of cloud base shall be reported above aerodrome elevation.
- (ii) When a precision approach runway in use has a threshold elevation of 50 ft (15 m) or more below the aerodrome elevation, local arrangements shall be made in order that the height of cloud bases reported to arriving aircraft shall refer to the threshold elevation.
- (iii) In the case of reports from offshore structures, the height of cloud base shall be given above mean sea level.

(f) Air temperature and dew-point temperature

- (1) The air temperature and dew-point temperature shall be measured, displayed and reported in degrees Celsius.
- (2) When automated equipment is used for the measurement of air temperature and dew-point temperature, the displays shall be located in the aeronautical meteorological station. The displays in the aeronautical meteorological station and in the air traffic services units shall relate to the same sensors.

(g) Atmospheric pressure

- (1) The atmospheric pressure shall be measured, and QNH and QFE values shall be computed and reported in hectopascals.
- (2) Display
 - (i) When automated equipment is used for the measurement of atmospheric pressure, QNH and, if required in accordance with point [MET.TR.205\(g\)\(3\)\(ii\)](#), QFE displays relating to the barometer shall be located in the aeronautical meteorological station with corresponding displays in the appropriate air traffic services units.
 - (ii) When QFE values are displayed for more than one runway, the displays shall be clearly marked to identify the runway to which the QFE value displayed refers.
- (3) Reference level

A reference level for the computation of QFE shall be used.

AMC1 MET.TR.210 Observing meteorological elements

ED Decision 2017/001/R

HUMAN OBSERVATION

Observers at an aerodrome should be located, as far as practical, so as to provide data which is representative of the area for which the observations are required.

GM1 MET.TR.210 Observing meteorological elements

ED Decision 2017/001/R

HUMAN OBSERVATION

When a semi-automatic observing system is used, the observer should be located, as far as practical, so as to supply data which is representative of the area for which the observations are required.

GM2 MET.TR.210 Observing meteorological elements

ED Decision 2022/004/R

OPERATIONALLY DESIRABLE ACCURACY OF OBSERVATION

<i>Element to be observed</i>	<i>Operationally desirable accuracy of measurement or observation*</i>
<i>Mean surface wind</i>	<i>Direction: ± 10° Speed: ± 1 kt up to 10 kt ± 10 % above 10 kt</i>
<i>Variations from the mean surface wind</i>	<i>± 2 kt, in terms of longitudinal and lateral components</i>
<i>Visibility</i>	<i>± 50 m up to 600 m ± 10 % between 600 m and 1 500 m ± 20 % above 1 500 m</i>
<i>Runway visual range</i>	<i>± 10 m up to 400 m ± 25 m between 400 m and 800 m ± 10 % above 800 m</i>
<i>Cloud amount</i>	<i>± 1 okta</i>
<i>Cloud height</i>	<i>± 33 ft up to 330 ft ± 10 % above 330 ft</i>
<i>Air temperature and dew-point temperature</i>	<i>± 1°C</i>
<i>Pressure value (QNH, QFE)</i>	<i>± 0.5 hPa</i>
<i>* The operationally desirable accuracy is not intended as an operational requirement; it is to be understood as a goal that has been expressed by the operators.</i>	

AMC1 MET.TR.210(a) Observing meteorological elements

ED Decision 2022/004/R

SURFACE WIND

- (a) When local routine report and local special report are used for departing or arriving aircraft, the surface wind observations for these reports should be representative of conditions along the runway or the touchdown zone respectively.

- (b) For METAR and SPECI, the surface wind observations should be representative of the conditions above the whole runway where there is only one runway, and the whole runway complex where there is more than one runway.

GM1 MET.TR.210(a) Observing meteorological elements

ED Decision 2017/001/R

SURFACE WIND — TAKE-OFF AND LANDING

Since, in practice, the surface wind cannot be measured directly on the runway, surface wind observations for take-off and landing are expected to be the best practicable indication of the winds which an aircraft will encounter during take-off and landing.

AMC1 MET.TR.210(a)(1) Observing meteorological elements

ED Decision 2020/008/R

SURFACE WIND — SITING

- (a) Reported surface wind should be representative of a wind at a height of 30 ± 3 ft (10 ± 1 m) above the ground.
- (b) Representative surface wind observations should be obtained by the use of sensors appropriately sited.
- (c) Sensors for surface wind observations for local routine report and local special report should be sited to give the best practicable indication of conditions along the runway and touchdown zones.
- (d) At aerodromes where topography or prevalent weather conditions cause significant differences in surface wind at various sections of the runway, additional sensors should be provided.

GM1 MET.TR.210(a)(1) Observing meteorological elements

ED Decision 2017/001/R

SURFACE WIND — SITING

Specifications concerning the siting of equipment and installations on operational areas, aiming at reducing the hazard to aircraft to a minimum, are contained in the EASA CS ADR-DSN.T.915 'Siting of equipment and installations on operational areas'.

AMC1 MET.TR.210(a)(2) Observing meteorological elements

ED Decision 2017/001/R

SURFACE WIND — DISPLAY

The mean values of, and significant variations in, the surface wind direction and speed for each sensor should be derived and displayed by automated equipment.

AMC1 MET.TR.210(a)(3) Observing meteorological elements

ED Decision 2022/004/R

SURFACE WIND — AVERAGING

The averaging period for measuring variations from the mean wind speed (gusts) reported in accordance with [MET.TR.205\(a\)\(3\)\(iii\)](#) should be 3 seconds for local routine report, local special report,

METAR, SPECI, and for wind displays used for depicting variations from the mean wind speed (gusts) in ATS units.

GM1 MET.TR.210(a)(3)(ii) Observing meteorological elements

ED Decision 2022/004/R

SURFACE WIND — AVERAGING — MARKED DISCONTINUITY

A marked discontinuity occurs when there is an abrupt and sustained change in wind direction of 30° or more, with a wind speed of 10 kt before or after the change, or a change in wind speed of 10 kt or more, lasting at least 2 minutes.

AMC1 MET.TR.210(b)(1) Observing meteorological elements

ED Decision 2022/004/R

VISIBILITY — GENERAL

- (a) When instrumented systems are used for the measurement of visibility, their output should be updated at least every 60 seconds to permit provision of current representative values.
- (b) When instrumented systems are used for the measurement of visibility, it should be measured at a height of approximately 7.5 ft (2.5 m) above the runway.
- (c) When local routine report and local special report are used for departing aircraft, the visibility observations for these reports should be representative of the conditions along the runway.
- (d) When local routine report and local special report are used for arriving aircraft, the visibility observations for these reports should be representative of the touchdown zone of the runway.
- (e) For METAR and SPECI, the visibility observations should be representative of the aerodrome.

AMC1 MET.TR.210(b)(2) Observing meteorological elements

ED Decision 2017/001/R

VISIBILITY — SITING

- (a) When instrumented systems are used for the measurement of visibility, representative visibility observations should be obtained by the use of sensors appropriately sited.
- (b) Sensors for visibility observations for local routine reports and local special reports should be sited to give the best practicable indications of visibility along the runway and touchdown zone.

AMC1 MET.TR.210(b)(4) Observing meteorological elements

ED Decision 2017/001/R

VISIBILITY — AVERAGING

The averaging period for visibility should be 1 minute for local routine reports and local special reports and for visibility displays in ATS units.

GM1 MET.TR.210(b)(4) Observing meteorological elements

ED Decision 2017/001/R

VISIBILITY — AVERAGING — MARKED DISCONTINUITY

A marked discontinuity occurs when there is an abrupt and sustained change in visibility, lasting at least 2 minutes, which reaches or passes through one or more of the following values: 800, 1 500 or 3 000 and, in cases where significant numbers of flights are operated in accordance with the visual flight rules, 5 000 m.

AMC1 MET.TR.210(c) Observing meteorological elements

ED Decision 2017/001/R

RUNWAY VISUAL RANGE (RVR) — ASSESSMENT

RVR should be assessed:

- (a) at a height of approximately 7.5 ft (2.5 m) above the runway for instrument systems or at a height of approximately 15 ft (5 m) above the runway by a human observer;
- (b) at a lateral distance from the runway centre line of not more than 120 m.

GM1 MET.TR.210(c) Observing meteorological elements

ED Decision 2020/008/R

RUNWAY VISUAL RANGE (RVR) — ASSESSMENT

A detailed understanding of the assessment of RVR is described in ICAO Doc 9328 'Manual on 'RVR — Observing and reporting practices'.

AMC1 MET.TR.210(c)(2) Observing meteorological elements

ED Decision 2022/004/R

RUNWAY VISUAL RANGE (RVR) — SITING

- (a) The site for observations to be representative of the touchdown zone should be located about 300 m along the runway from the threshold.
- (b) The sites for observations to be representative of the mid-point and stop-end of the runway should be located at a distance of 1 000 to 1 500 m along the runway from the threshold and at a distance of about 300 m from the other end of the runway.
- (c) The exact position of these sites and, if necessary, additional sites should be decided after considering aeronautical, meteorological and climatological factors such as long runways, swamps and other fog-prone areas.

AMC1 MET.TR.210(c)(3) Observing meteorological elements

ED Decision 2022/004/R

RUNWAY VISUAL RANGE (RVR) — RUNWAY LIGHT INTENSITY

- (a) Instrumented systems should consider the runway light intensity.
- (b) When instrumented systems are used for the assessment of RVR, computations should be made separately for each available runway.

- (c) For local routine report and local special report, the light intensity to be used for the computation should be:
- (1) for a runway with the lights switched on and a light intensity of more than 3 % of the maximum light intensity available, the light intensity actually in use on that runway;
 - (2) for a runway with the lights switched on and a light intensity of 3 % or less of the maximum light intensity available, the optimum light intensity that would be appropriate for operational use in the prevailing conditions; and
 - (3) for a runway with lights switched off (or at the lowest setting pending the resumption of operations), the optimum light intensity that would be appropriate for operational use in the prevailing conditions.
- (d) In METAR and SPECI, the RVR should be based on the maximum light intensity available on the runway.

GM1 MET.TR.210(c)(3) Observing meteorological elements

ED Decision 2022/004/R

RUNWAY VISUAL RANGE (RVR) — USE OF INSTRUMENTED SYSTEMS

- (a) Since accuracy can vary from one instrument design to another, performance characteristics are to be checked before selecting an instrument for assessing the runway visual range.
- (b) The calibration of a forward-scatter meter has to be traceable and verifiable to a transmissometer standard, whose accuracy has been verified over the intended operational range.
- (c) Guidance on the use of transmissometers and forward-scatter meters in instrumented Runway Visual Range systems is given in ICAO Doc 9328 'Manual of Runway Visual Range Observing and Reporting Practices'.

GM2 MET.TR.210(c)(3) Observing meteorological elements

ED Decision 2022/004/R

RUNWAY VISUAL RANGE (RVR)

Instrumented systems based on transmissometer or forward-scatter meters must be used to assess RVR on runways intended for Categories II and III instrument approach and landing operations. For Category I instrument approach, other means to assess RVR exist and the assessment of RVR by means of instrumented systems based on transmissometer or forward-scatter meters are therefore not required. However, if the competent authority considers that an instrument system is required at certain aerodromes, it may decide so. Therefore, the requirement in [MET.TR.210\(c\)\(2\)](#) provides this option, which is consistent with the ICAO Annex 3 approach.

GM1 MET.TR.210(c)(5)(ii)(B) Observing meteorological elements

ED Decision 2022/004/R

RUNWAY VISUAL RANGE (RVR) — AVERAGING

A marked discontinuity occurs when there is an abrupt and sustained change in RVR, lasting at least 2 minutes, which reaches or passes through the values 800, 550, 300 and 175 m.

AMC1 MET.TR.210(d)(1) Observing meteorological elements

ED Decision 2022/004/R

PRESENT WEATHER — GENERAL

- (a) For local routine report and local special report, the present weather information should be representative of the conditions at the aerodrome.
- (b) For METAR and SPECI, the present weather information should be representative of the conditions at the aerodrome and, for certain specified present weather phenomena, in its vicinity.

AMC1 MET.TR.210(d)(2) Observing meteorological elements

ED Decision 2017/001/R

PRESENT WEATHER — SITING

When instrumented systems are used for observing present weather phenomena listed under [AMC2 MET.TR.205\(d\)](#), [MET.TR.205\(d\)\(3\)](#) and [AMC1 MET.TR.205\(d\)\(3\)](#), representative information should be obtained by the use of sensors appropriately sited.

AMC1 MET.TR.210(e) Observing meteorological elements

ED Decision 2022/004/R

CLOUDS — GENERAL

- (a) Cloud observations for local routine report and local special report should be representative of the runway threshold(s) in use.
- (b) Cloud observations for METAR and SPECI should be representative of the aerodrome and its vicinity.

AMC1 MET.TR.210(e)(2) Observing meteorological elements

ED Decision 2020/008/R

CLOUDS — SITING

- (a) When instrumented systems are used for the measurement of the cloud amount and the height of cloud base, representative observations should be obtained by the use of sensors appropriately sited.
- (b) For local routine report and local special report, in the case of aerodromes with precision approach runways, sensors for cloud amount and height of cloud base should be sited to give the best practicable indications of the cloud amount and height of cloud base at the threshold of the runway in use. For that purpose, a sensor should be installed at a distance of less than 4 000 ft (1 200 m) before the landing threshold.

AMC1 MET.TR.210(f) Observing meteorological elements

ED Decision 2022/004/R

AIR TEMPERATURE AND DEW-POINT TEMPERATURE

Observations of air temperature and dew-point temperature for local routine report, local special report, METAR and SPECI, should be representative of the whole runway complex.

AMC1 MET.TR.210(g)(3) Observing meteorological elements

ED Decision 2017/001/R

ATMOSPHERIC PRESSURE — REFERENCE LEVEL

- (a) The reference level for the computation of QFE should be the aerodrome elevation.
- (b) For non-precision approach runways, whose thresholds are 7 ft (2 m) or more below the aerodrome elevation, and for precision approach runways, the QFE, if required, should refer to the relevant threshold elevation.

CHAPTER 2 — TECHNICAL REQUIREMENTS FOR AERODROME METEOROLOGICAL OFFICES

MET.TR.215 Forecasts and other information

Regulation (EU) 2021/1338

- (a) Meteorological information for operators and flight crew members shall:
 - (1) cover the flight in respect of time, altitude and geographical extent;
 - (2) relate to appropriate fixed times or periods of time;
 - (3) extend to the aerodrome of intended landing, also covering the meteorological conditions expected between the aerodrome of intended landing and alternate aerodromes designated by the operator;
 - (4) be up to date.
- (b) Meteorological information provided to rescue coordination centres shall include the meteorological conditions that existed in the last known position of a missing aircraft and along the intended route of that aircraft with particular reference to elements which are not being distributed routinely.
- (c) Meteorological information provided to aeronautical information services units shall include:
 - (1) information on meteorological service intended for inclusion in the aeronautical information publication(s) concerned;
 - (2) information necessary for the preparation of NOTAM or ASHTAM;
 - (3) information necessary for the preparation of aeronautical information circulars.
- (d) Meteorological information included in flight documentation shall be represented as follows:
 - (1) winds on charts shall be depicted by arrows with feathers and shaded pennants on a sufficiently dense grid;
 - (2) temperatures shall be depicted by figures on a sufficiently dense grid;
 - (3) wind and temperature data selected from the data sets received from a world area forecast centre shall be depicted in a sufficiently dense latitude/longitude grid;
 - (4) wind arrows shall take precedence over temperatures and chart background;
 - (5) height indications referring to en-route meteorological conditions shall be expressed as determined to be appropriate for the situation, for instance in flight levels, pressure, altitude or height above ground level, whilst all references referring to aerodrome meteorological conditions shall be expressed in height above the aerodrome elevation.
- (e) Flight documentation shall comprise:
 - (1) forecasts of upper-wind and upper-air temperature;
 - (2) SIGWX phenomena;
 - (3) METAR or, when issued, SPECI for the aerodromes of departure and intended landing, and for take-off, en-route and destination alternate aerodromes;

- (4) TAF or amended TAF for the aerodromes of departure and intended landing, and for take-off, en-route and destination alternate aerodromes;
- (5) SIGMET, and, when issued, AIRMET and appropriate special air-reports relevant to the whole route;
- (6) volcanic ash, tropical cyclone and space weather advisory information relevant to the whole route.

However, when agreed between the aerodrome meteorological office and the operators concerned, flight documentation for flights of two hours' duration or less, after a short stop or turnaround, may be limited to the information operationally needed, but in all cases the flight documentation shall at least comprise the meteorological information listed in points (3), (4), (5) and (6).

- (f) Charts generated from digital forecasts shall be made available, as required by operators, for fixed areas of coverage as shown in Appendix 2.
- (g) When forecasts of upper-wind and upper-air temperature listed under point [MET.OR.275\(a\)\(1\)](#) are supplied in chart form, they shall be fixed-time prognostic charts for flight levels as specified in point [MET.TR.275\(b\)\(3\)](#). When forecasts of SIGWX phenomena listed under point [MET.OR.275\(a\)\(2\)](#) are supplied in chart form, they shall be fixed-time prognostic charts for an atmospheric layer limited by flight levels as specified in points [MET.TR.275\(c\)](#) and [MET.TR.275\(d\)](#).
- (h) The forecasts of upper-wind and upper-air temperature and of SIGWX phenomena above flight level 100 shall be supplied as soon as they become available, but not later than 3 hours before departure.
- (i) Aeronautical climatological information shall be prepared in the form of aerodrome climatological tables and aerodrome climatological summaries.

AMC1 MET.TR.215(a) Forecasts and other information

ED Decision 2017/001/R

METEOROLOGICAL INFORMATION FOR OPERATORS AND FLIGHT CREW

Meteorological information provided to operators and flight crew members should be provided by means of one or more of the following:

- (a) written or printed material, including specified charts and forms;
- (b) data in a digital form;
- (c) briefing;
- (d) consultation;
- (e) display; or
- (f) an automated pre-flight information system providing self-briefing and flight documentation facilities while retaining access by operators and aircrew members to consultation, as necessary, with the aerodrome meteorological office.

AMC2 MET.TR.215(a) Forecasts and other information

ED Decision 2017/001/R

SPECIFIC INFORMATION FOR HELICOPTER OPERATIONS

- (a) Meteorological information for pre-flight planning and in-flight replanning by operators of helicopters flying to offshore structures should include data covering the layers from sea level to flight level 100.
- (b) Particular mention should be made of the expected surface visibility, the amount, type, where available, base and tops of cloud below flight level 100, sea state and sea-surface temperature, mean sea-level pressure, and the occurrence and expected occurrence of turbulence and icing.

AMC3 MET.TR.215(a) Forecasts and other information

ED Decision 2020/008/R

AUTOMATED PRE-FLIGHT INFORMATION SYSTEMS

Automated pre-flight information systems for the supply of meteorological information for self-briefing, pre-flight planning and flight documentation should:

- (a) provide for the continuous and timely updating of the system database and monitoring of the validity and integrity of the meteorological information stored;
- (b) permit access to the system by operators and flight crew members and also by other aeronautical users concerned through suitable telecommunications means;
- (c) use access and interrogation procedures based on abbreviated plain language and, as appropriate, ICAO location indicators, and aeronautical meteorological code data-type designators prescribed by WMO, or based on a menu-driven user interface, or other appropriate mechanisms as agreed between the meteorological services provider and the operators concerned; and
- (d) provide for rapid response to a user request for information.

GM1 MET.TR.215(a) Forecasts and other information

ED Decision 2022/004/R

AUTOMATED PRE-FLIGHT INFORMATION SYSTEMS

- (a) ICAO abbreviations and codes and location indicators are given respectively in ICAO Doc 8400 'Procedures for Air Navigation Services — ICAO Abbreviations and Codes (PANS-ABC)' and ICAO Doc 7910 'Location Indicators'.
- (b) Aeronautical meteorological code data-type designators are given in the WMO Publication No 386 'Manual on the Global Telecommunication System'.

GM1 MET.TR.215(b) Forecasts and other information

ED Decision 2017/001/R

RESCUE COORDINATION CENTRES

- (a) The elements which are not distributed routinely are:
 - (1) state of ground, and in particular any snow cover or flooding;

- (2) sea-surface temperature, state of the sea, ice cover (if any) and ocean currents, if relevant to the search area; and
 - (3) sea-level pressure data.
- (b) On request from the rescue coordination centre, the designated aerodrome meteorological office or meteorological watch office should arrange to obtain details of the flight documentation which was supplied to the missing aircraft, together with any amendments to the forecast which were transmitted to the aircraft in flight.

GM2 MET.TR.215(b) Forecasts and other information

ED Decision 2017/001/R

RESCUE COORDINATION CENTRES

Information to be supplied to rescue coordination centres includes:

- (a) significant en-route weather phenomena;
- (b) cloud amount and type, particularly cumulonimbus; height indications of bases and tops;
- (c) visibility and phenomena reducing visibility;
- (d) surface wind and upper wind;
- (e) state of ground, in particular, any snow cover or flooding;
- (f) sea-surface temperature, state of the sea, ice cover if any and ocean currents, if relevant to the search area; and
- (g) sea-level pressure data.

AMC1 MET.TR.215(d)(5) Forecasts and other information

ED Decision 2017/001/R

HEIGHT INDICATIONS REFERENCES TO EN-ROUTE METEOROLOGICAL CONDITIONS

All references to en-route meteorological conditions, such as height indications of upper winds, turbulence or bases and tops of clouds, should be expressed in flight levels. Height indications referred to en-route meteorological conditions may also be expressed in pressure, altitude or, for low-level flights, in height above ground level.

AMC1 MET.TR.215(e) Forecasts and other information

ED Decision 2020/008/R

FLIGHT DOCUMENTATION

- (a) Where the forecasts are supplied in chart form, flight documentation for low-level flights, including those in accordance with the visual flight rules, operating up to flight level 100 or up to flight level 150 in mountainous areas or higher, where necessary, should contain the following as appropriate to the flight:
- (1) information from relevant SIGMET and AIRMET;
 - (2) upper wind and upper-air temperature charts; and
 - (3) significant weather charts.

- (b) Where the forecasts are not supplied in chart form, flight documentation for low-level flights, including those in accordance with the visual flight rules, operating up to flight level 100 or up to flight level 150 in mountainous areas or higher, where necessary, should contain the following information as appropriate to the flight: SIGMET and AIRMET information.























AMC1 MET.TR.215(e)(1) & (2) Forecasts and other information

ED Decision 2017/001/R

FLIGHT DOCUMENTATION — LEGEND FOR THE CHARTS















When the flight documentation related to forecasts of upper wind and upper-air temperature and SIGWX phenomena is presented in the form of charts, it should be in accordance with the below sheet of notations used in flight documentation.

1. Symbols for significant weather

	Tropical cyclone		Drizzle
	Severe squall line*		Rain
	Moderate turbulence		Snow
	Severe turbulence		Shower
	Mountain waves		Hail
	Widespread blowing snow		Severe sand or dust haze
	Moderate aircraft icing		Widespread sandstorm or duststorm
	Severe aircraft icing		Widespread haze
	Widespread fog		Widespread mist
	Radioactive materials in the atmosphere**		Widespread smoke
	Volcanic eruption***		Freezing precipitation****
	Mountain obscuration		

- * In-flight documentation for flights operating up to FL 100. This symbol refers to "squall line".
 - ** The following information should be included in a separate text box on the chart: radioactive materials in the atmosphere symbol; latitude/longitude of release site; and (if known) the name of the site of the radioactive source. In addition, the legend of SIGWX charts on which a release of radiation is indicated should contain "CHECK SIGMET AND NOTAM FOR RDOACT CLD". The centre of the radioactive materials in the atmosphere symbol should be placed on significant weather charts at the latitude/longitude site of the radioactive source.
 - *** The following information should be included in a separate text box on the chart: volcanic eruption symbol; the name of the volcano (if known); and the latitude/longitude of the eruption. In addition, the legend of SIGWX charts should indicate "CHECK SIGMET, ADVISORIES FOR TC AND VA, AND ASHTAM AND NOTAM FOR VA". The dot on the base of the volcanic eruption symbol should be placed on significant weather charts at the latitude/longitude site of the volcanic event.
 - **** This symbol does not refer to icing due to precipitation coming into contact with an aircraft which is at a very low temperature.
- Note: Height indications between which phenomena are expected, top above base as per chart legend.

2. Fronts and convergence zones and other symbols used

	Cold front at the surface		Position, speed and level of maximum wind
	Warm front at the surface		Convergence line
	Occluded front at the surface		Freezing level
	Quasi-stationary front at the surface		Intertropical convergence zone
	Tropopause high		State of the sea
	Tropopause low		Sea-surface temperature
	Tropopause level		Widespread strong surface wind*

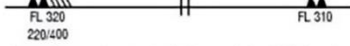

 FL 320 220/400 FL 310

Wind arrows indicate the maximum wind in jet and the flight level at which it occurs. If the maximum wind speed is 60 m/s (120 kt) or more, the flight levels between which winds are greater than 40 m/s (80 kt) is placed below the maximum wind level. In the example, winds are greater than 40 m/s (80 kt) between FL 220 and FL 400. The heavy line delineating the jet axis begins/ends at the points where a wind speed of 40 m/s (80 kt) is forecast.

 Symbol used whenever the height of the jet axis changes by +/-3000 ft or the speed changes by +/-20 kt
 * This symbol refers to widespread surface wind speeds exceeding 15 m/s (30 kt).

3. Abbreviations used to describe clouds

- 3.1 Type
- | | | |
|-------------------|--------------------|-------------------|
| CI = Cirrus | AS = Altostratus | ST = Stratus |
| CC = Cirrocumulus | NS = Nimbostratus | CU = Cumulus |
| CS = Cirrostratus | SC = Stratocumulus | CB = Cumulonimbus |
| AC = Alto cumulus | | |
- 3.2 Amount
- Clouds except CB
- | | |
|------------------------------|---------------------------|
| FEW = few (1/8 to 2/8) | BKN = broken (5/8 to 7/8) |
| SCT = scattered (3/8 to 4/8) | OVC = overcast (8/8) |
- CB only
- | |
|---|
| ISOL = individual CBs (isolated) |
| OCNL = well-separated CBs (occasional) |
| FRQ = CBs with little or no separation (frequent) |
| EMBD = CBs embedded in layers of other clouds or concealed by haze (embedded) |

3.3 Heights

- Heights are indicated on SWH and SWM charts in flight levels (FL), top over base. When XXX is used, tops or bases are outside the layer of the atmosphere to which the chart applies.
- In SWL charts:
- Heights are indicated as altitudes above mean sea level;
 - The abbreviation SFC is used to indicate ground level.

4. Depicting of lines and systems on specific charts

4.1 Models SWH and SWM – Significant weather charts (high and medium)

- | | |
|---|---|
| Scalloped line | = demarcation of areas of significant weather |
| Heavy broken line | = delineation of area of CAT |
| Heavy solid line interrupted by wind arrow and flight level | = position of jet stream axis with indication of wind direction, speed in kt or m/s and height in flight levels. The vertical extent of the jet stream is indicated (in flight levels), e.g. FL 270 accompanied by 240/290 indicates that the jet extends from FL 240 to FL 290. |
| Flight levels inside small rectangles | = height in flight levels of tropopause at spot locations, e.g.  . Low and high points of the tropopause topography are indicated by the letters L or H, respectively, inside a pentagon with the height in flight levels. Display explicit FL for jet depths and tropopause height even if outside forecast bounds. |

4.2 Model SWL – Significant weather chart (low level)

- | | |
|--|---|
| X | = position of pressure centres given in hectopascals |
| L | = centre of low pressure |
| H | = centre of high pressure |
| Scalloped lines | = demarcation of area of significant weather |
| Dashed lines | = altitude of 0°C isotherm in feet (hectofeet) or metres
Note: 0°C level may also be indicated by  , i.e. 0°C level is at an altitude of 6000 ft. |
| Figures on arrows | = speed in kt or km/h of movement of frontal systems, depressions or anticyclones |
| Figure inside the state of the sea symbol | = total wave height in feet or metres |
| Figure inside the sea-surface temperature symbol | = sea-surface temperature in °C |
| Figures inside the strong surface wind symbol | = wind in kt or m/s |

4.3 Arrows, feathers and pennants

Arrows indicate direction. Number of pennants and/or feathers correspond to speed.

- Example: 270°/115 kt (equivalent to 57.5 m/s)
- Pennants correspond to 50 kt or 25 m/s
 - Feathers correspond to 10 kt or 5 m/s
 - Half-feathers correspond to 5 kt or 2.5 m/s

* A conversion factor of 1 to 2 is used.

GM1 MET.TR.215(e)(1) & (2) Forecasts and other information

ED Decision 2022/004/R

MODEL CHARTS

This guidance provides examples of model charts.

(a) UPPER WIND AND TEMPERATURE CHART FOR STANDARD ISOBARIC SURFACE

MODEL IS

Example 1. Arrows, feathers and pennants (Mercator projection)

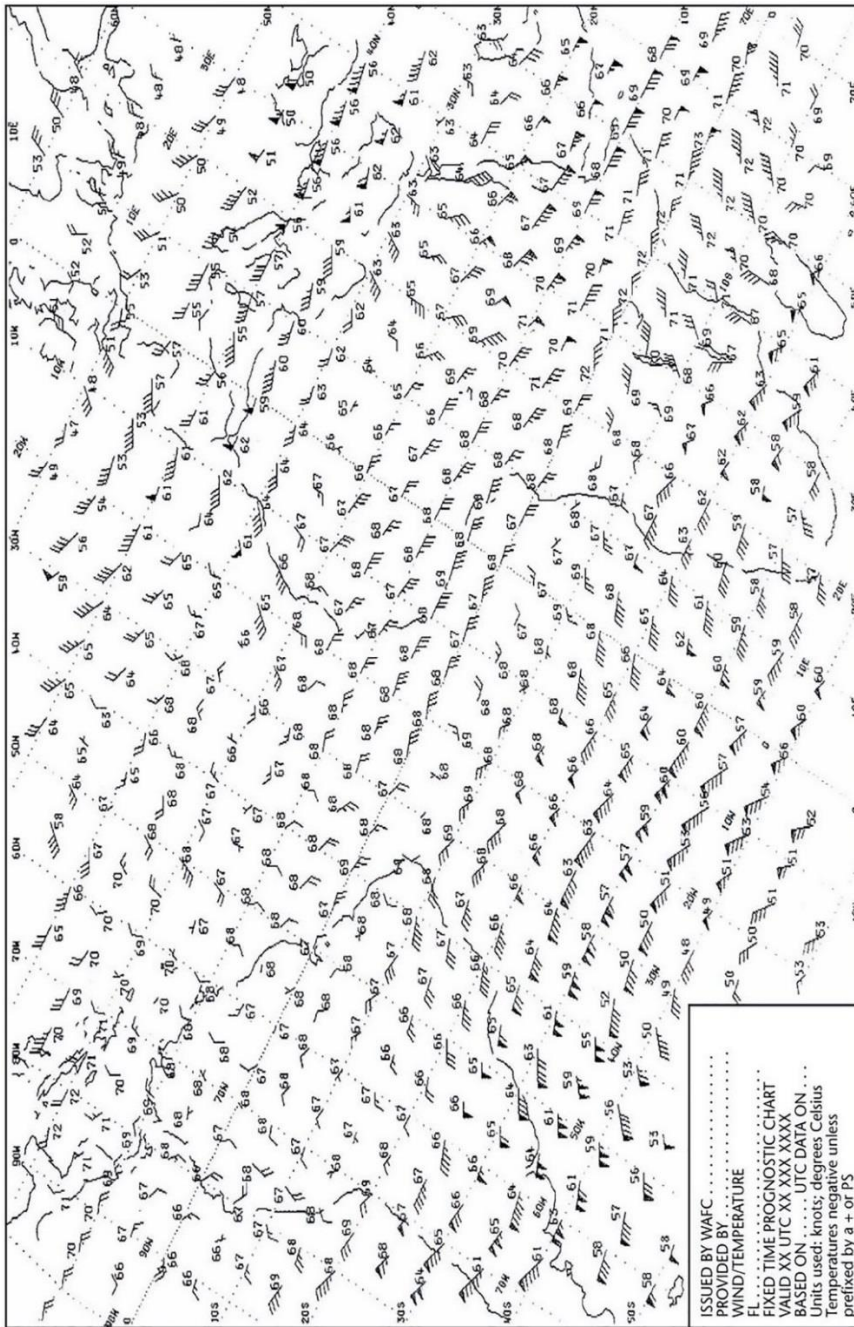

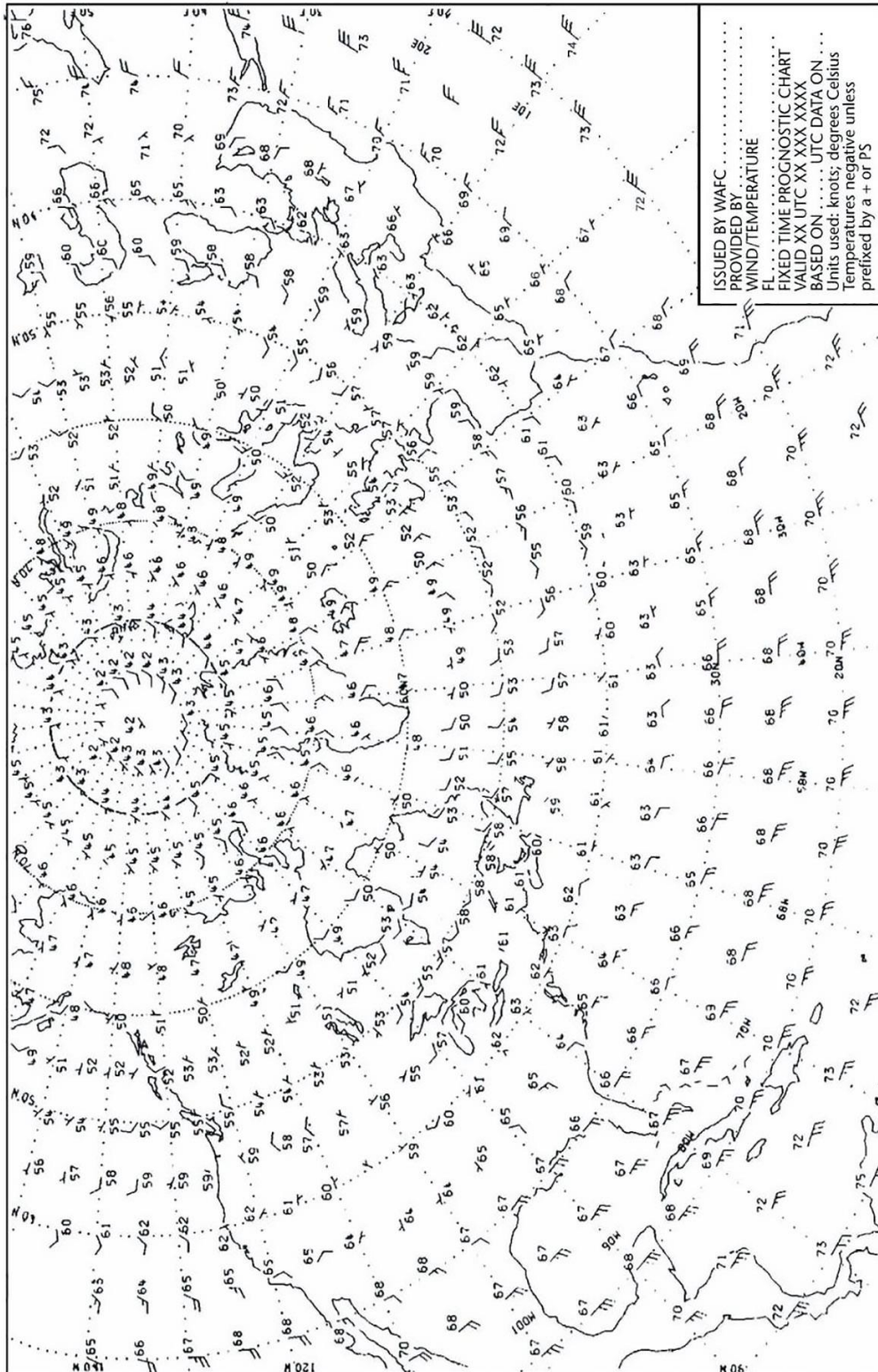
(b) UPPER WIND AND TEMPERATURE CHART FOR STANDARD ISOBARIC SURFACE**MODEL IS****Example 2. Arrows, feathers and pennants (Polar stereographic projection)**

**(d) SIGNIFICANT WEATHER CHART (MEDIUM LEVEL)
MODEL SWM**

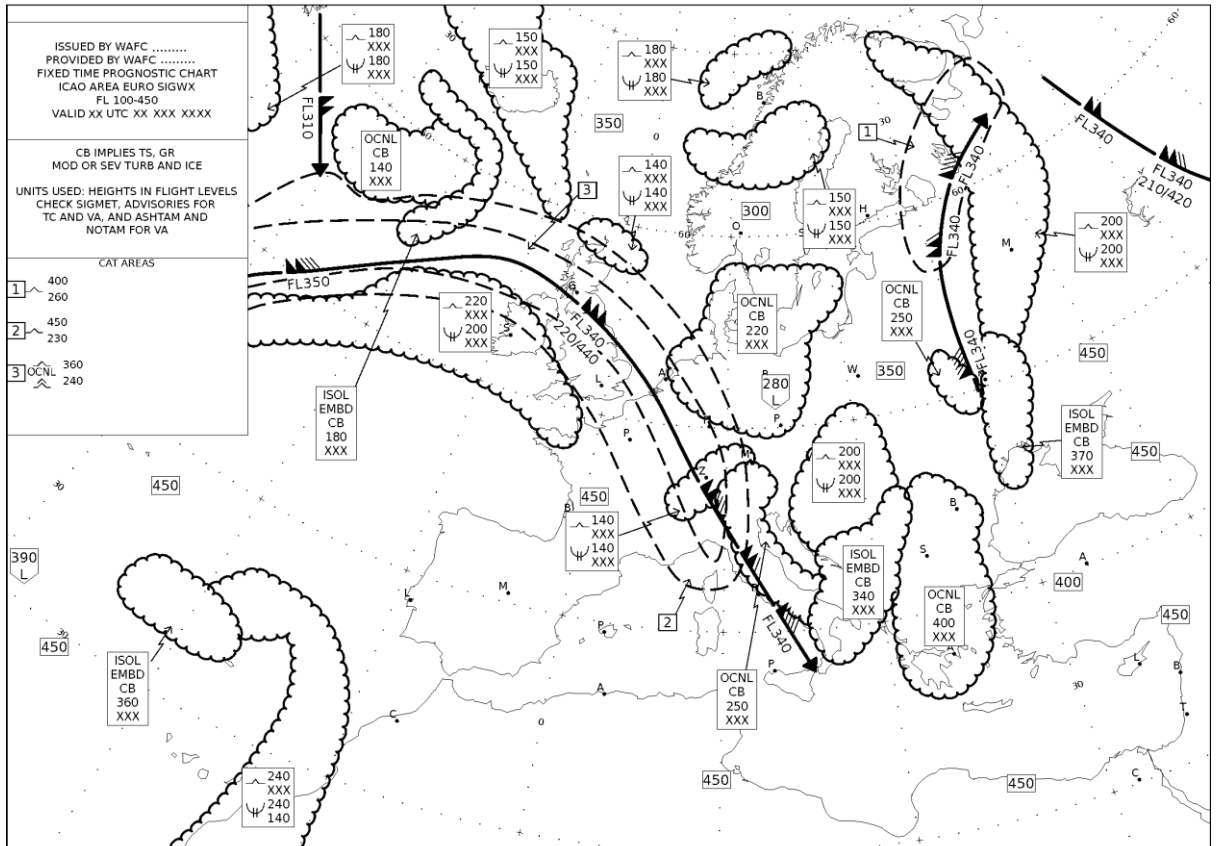

(e) SIGNIFICANT WEATHER CHART (LOW LEVEL)

MODEL SWL

Example 1

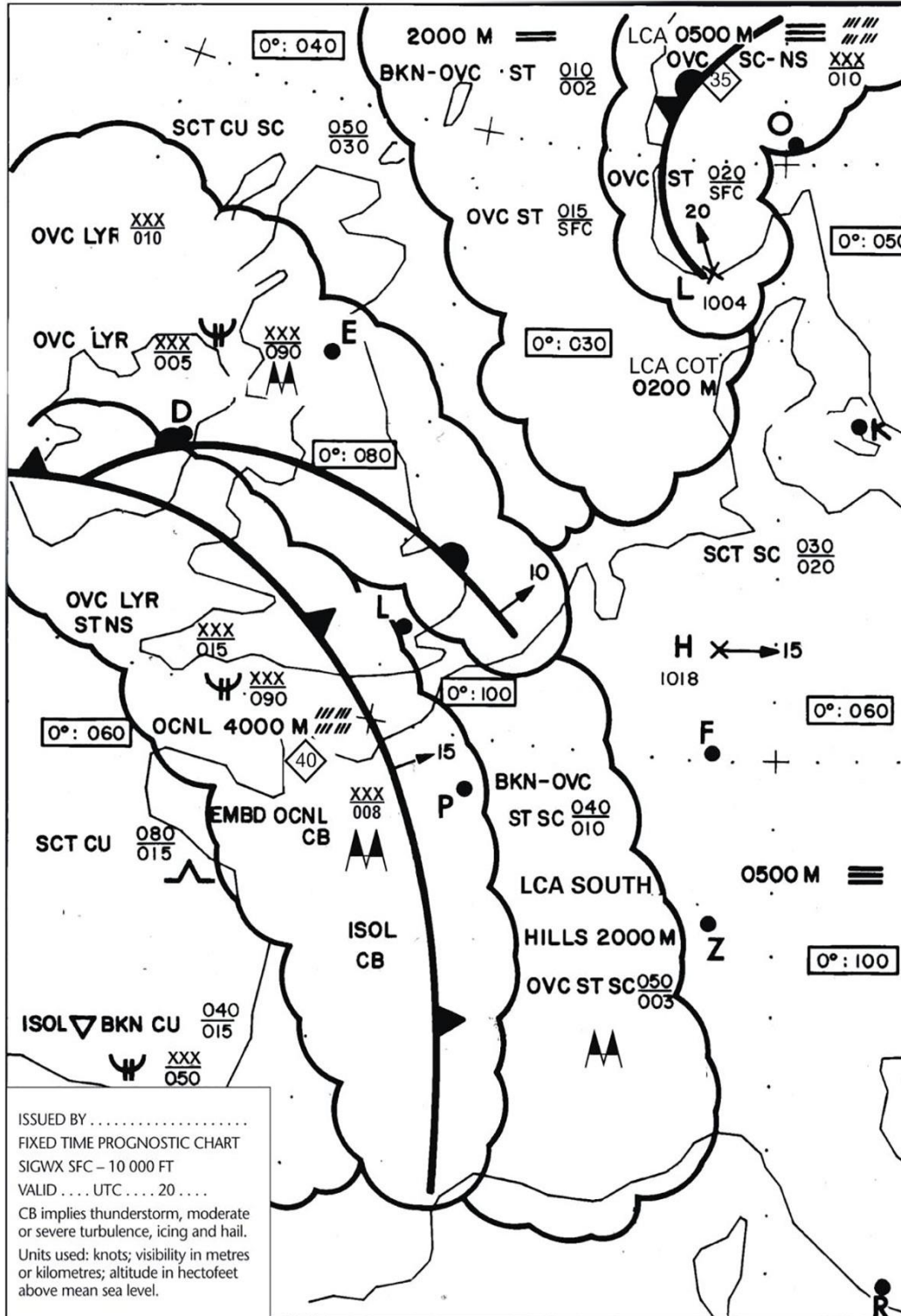

(f) SIGNIFICANT WEATHER CHART (LOW LEVEL)

MODEL SWL

Example 2

FIXED TIME PROGNOSTIC CHART		VALID	UTC	20	BASED ON	UTC DATA ON	0°C
VARIANT	VIS	SIGNIFICANT WEATHER	CLOUD, TURBULENCE, ICING				
AREA A			~ SCT CU 025/080				50
ISOL			~ BKN CU 015/XXX Ψ 050/XXX				
AREA B			~ OVC LVR ST NS 015/XXX Ψ 050/XXX				
OCNL	4000	HEAVY RAIN	EMBD CB 008/XXX AA				50
ISOL	1000	THUNDERSTORM					
AREA C			BKN to OVC ST SC 010/040				
LCA SOUTH COT HILLS	2000	DRIZZLE	OVC ST SC 003/050 AA				100
AREA D			OVC LVR SC NS 010/XXX				
LCA NORTH	4500	RAIN	OVC LVR ST NS 005/XXX Ψ 090/XXX AA				90
AREA E			SCT SC 020/030				
LCA LAND	0500	FOG					40
AREA F	2000	MIST	BKN to OVC ST 002/010				
LCA COT HILLS	0200	FOG	OVC ST SFC/015				30
AREA G	4500	RAIN	~ OVC CU SC NS 010/XXX Ψ 030/XXX				
LCA NORTH	0500	FOG	OVC ST SFC/010				30
AREA J			SCT CU SC 030/050				
LCA HILLS NORTH			~ BLW 070				40

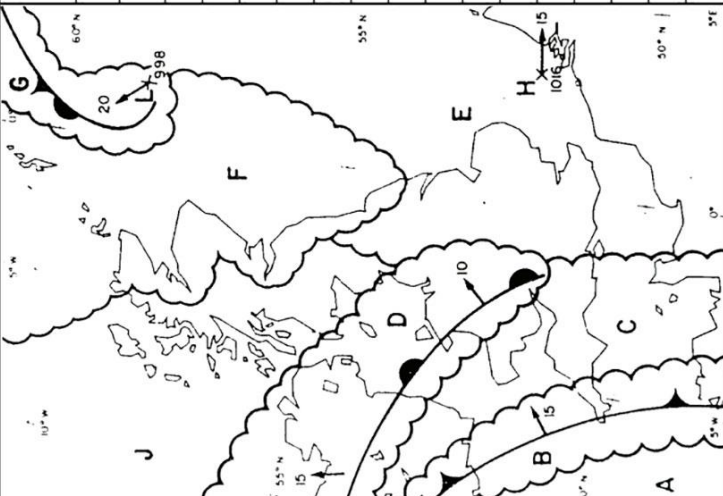
	<p>REMARKS: EAST TO NE GALES SHETLAND TO HEBRIDES - SEVERE MOUNTAIN WAVES NW SCOTLAND - FOG PATCHES EAST ANGLIA - WDSR FOG OVER NORTH FRANCE, BELGIUM AND THE NETHERLANDS</p>
--	---

<p>SIGWX SFC - 10 000 FT ISSUED BY AT UTC</p> <p>Notes: 1. Pressure in hPa and speeds in knots. 2. Vis in m included if less than 5 000 m. AA implies vis 2000 m or less. 3. Altitude in hectofeet above MSL XXX = above 10 000 ft. 4. CB implies MOD/SEV icing, turbulence and thunderstorm. 5. Only significant weather and/or weather phenomena causing visibility reduction below 5 000 m included.</p>	<p>FIXED TIME PROGNOSTIC CHART</p>
---	------------------------------------

AMC2 MET.TR.215(e)(1) & (2) Forecasts and other information

ED Decision 2017/001/R

FORMAT OF FLIGHT DOCUMENTATION

The location indicators and the abbreviations used should be explained in the flight documentation.

AMC1 MET.TR.215(f) Forecasts and other information

ED Decision 2020/008/R

CHARTS

Charts included in flight documentation should have a high standard of clarity and legibility and should have the following physical characteristics:

- (a) For convenience, the largest size of charts should be about 42 × 30 cm (standard A3 size) and the smallest size should be about 21 × 30 cm (standard A4 size). The choice between these sizes should depend on the route lengths and the amount of detail that needs to be given in the charts as agreed between the aerodrome meteorological office and the users concerned;
- (b) Major geographical features, such as coastlines, major rivers and lakes, should be depicted in a way that makes them easily recognisable;
- (c) For charts prepared by computer, meteorological data should take preference over basic chart information, the former cancelling the latter wherever they overlap;
- (d) Major aerodromes should be shown as a dot and identified by the first letter of the name of the city the aerodrome serves as given in Table AOP of the EUR air navigation plan;
- (e) A geographical grid should be shown with meridians and parallels represented by dotted lines at each 10°-latitude and longitude; dots should be spaced one degree apart;
- (f) Latitude and longitude values should be indicated at various points throughout the charts; and
- (g) Labels on the charts for flight documentation should be clear and simple and should present the name of the world area forecast centre or, for non-WAFS products, the originating centre, the type of chart, date and valid time and, if necessary, the types of units used in an unambiguous way.

AMC2 MET.TR.215(f) Forecasts and other information

ED Decision 2022/004/R

CHARTS

- (a) The minimum number of charts for flights between flight level 250 and flight level 630 should include a high-level SIGWX chart (flight level 250 to flight level 630) or a medium-level SIGWX chart (flight level 100 to flight level 450), if appropriate, and a forecast flight level 340 wind and temperature chart.
- (b) The actual charts provided for pre-flight and in-flight planning and for flight documentation should be agreed between the meteorological providers and the users concerned.

GM1 MET.TR.215(f) Forecasts and other information

ED Decision 2017/001/R

CHARTS — SHORT-HAUL FLIGHTS

For short-haul flights, charts should be prepared covering limited areas at a scale of $1:15 \times 10^6$ as required.

GM2 MET.TR.215(f) Forecasts and other information

ED Decision 2022/004/R

MAP PROJECTIONS — CORRECT CONVERSION BETWEEN DIFFERENT MAP PROJECTIONS

When plotting shapes, particularly polygons, on maps, appropriate corrections are necessary if they are plotted on projections different to those used in the production of the original forecast area.

GM1 MET.TR.215(g) Forecasts and other information

ED Decision 2020/008/R

FORECASTS IN CHART FORM

- (a) Charts related to concatenated route-specific upper wind and upper-air temperature forecasts should be provided as agreed between the meteorological service provider and the operator concerned.
- (b) Guidance on the design, formulation and use of concatenated charts is given in ICAO DOC 8896 'Manual of Aeronautical Meteorological Practice' as last amended.

AMC1 MET.TR.215(i) Forecasts and other information

ED Decision 2017/001/R

CLIMATOLOGICAL INFORMATION — PERIOD OF OBSERVATION

Aeronautical climatological information should be based on observations made over a period of at least five years. The period should be indicated in the information supplied.

AMC2 MET.TR.215(i) Forecasts and other information

ED Decision 2017/001/R

CLIMATOLOGICAL DATA RELATED TO SITES FOR NEW AERODROMES

Climatological data related to sites for new aerodromes and to additional runways at existing aerodromes should be collected starting as early as possible before the commissioning of those aerodromes or runways.

AMC3 MET.TR.215(i) Forecasts and other information

ED Decision 2017/001/R

CLIMATOLOGICAL SUMMARIES

Aerodrome climatological summaries should follow the procedures prescribed by the World Meteorological Organization and should be made available in a form to meet a specific user request.

AMC4 MET.TR.215(i) Forecasts and other information

ED Decision 2017/001/R

CLIMATOLOGICAL TABLE

An aerodrome climatological table should indicate:

- (a) mean values and variations therefrom, including maximum and minimum values, of meteorological elements; and/or
- (b) the frequency of occurrence of present weather phenomena affecting flight operations at the aerodrome; and/or
- (c) the frequency of occurrence of specified values of one, or of a combination of two or more, elements.

AMC5 MET.TR.215(i) Forecasts and other information

ED Decision 2017/001/R

CLIMATOLOGICAL TABLE

Aerodrome climatological tables should include information required for the preparation of aerodrome climatological summaries.

AMC6 MET.TR.215(i) Forecasts and other information

ED Decision 2017/001/R

CLIMATOLOGICAL SUMMARIES

Aerodrome climatological summaries should cover:

- (a) frequencies of the occurrence of runway visual range/visibility and/or height of base of the lowest cloud layer of BKN or OVC extent below specified values at specified times;
- (b) frequencies of visibility below specified values at specified times;
- (c) frequencies of the height of base of the lowest cloud layer of BKN or OVC extent below specified values at specified times;
- (d) frequencies of occurrence of concurrent wind direction and speed within specified ranges;
- (e) frequencies of surface temperature in specified ranges of 5°C at specified times; and
- (f) mean values and variations therefrom, including maximum and minimum values of meteorological elements required for operational planning purposes, including take-off performance calculations.

GM1 MET.TR.215(i) Forecasts and other information

ED Decision 2017/001/R

CLIMATOLOGICAL INFORMATION

In cases where it is impracticable to meet the requirements for aeronautical climatological information on a national basis, the collection, processing and storage of observational data may be effected through computer facilities available for international use, and the responsibility for the preparation of the required aeronautical climatological information may be delegated by agreement between the competent authorities concerned.

GM2 MET.TR.215(i) Forecasts and other information

ED Decision 2020/008/R

CLIMATOLOGICAL SUMMARIES — MODELS

Models of climatological summaries related to (a) to (e) of [AMC6 MET.TR.215\(i\)](#) are given in the WMO Publication No 49, Technical Regulations, Volume II, Part III – ‘AERONAUTICAL CLIMATOLOGY’.

GM3 MET.TR.215(i) Forecasts and other information

ED Decision 2022/004/R

CLIMATOLOGICAL DATA FOR AERODROME PLANNING PURPOSES

Climatological data required for aerodrome planning purposes is set out in [GM1 ADR-DSN.B.025](#) ‘Data to be used’.

MET.TR.220 Aerodrome forecasts

Regulation (EU) 2021/1338

- (a) Aerodrome forecasts and amendments thereto shall be issued as a TAF and shall include, in the order indicated, the:
- (1) identification of the type of forecast;
 - (2) location indicator;
 - (3) time of issue of forecast;
 - (4) identification of a missing forecast, when applicable;
 - (5) date and period of validity of forecast;
 - (6) identification of a cancelled forecast, when applicable;
 - (7) surface wind;
 - (8) visibility;
 - (9) weather;
 - (10) cloud;
 - (11) expected significant changes to one or more of these elements during the period of validity.
- (b) TAF shall be issued in accordance with the template shown in [Appendix 3](#).
- (c) The period of validity of a routine TAF shall be either 9 or 24 or 30 hours, unless otherwise prescribed by the competent authority taking into account the traffic requirements for aerodromes which operate for less than 9 hours.
- (d) TAF shall be filed for transmission not earlier than 1 hour before the commencement of their period of validity.
- (e) The meteorological elements included in TAF shall be:
- (1) Surface wind
 - (i) In forecasting surface wind, the expected prevailing direction shall be given.

- (ii) When it is not possible to forecast a prevailing surface wind direction due to its expected variability, the forecasted wind direction shall be indicated as variable using 'VRB'.
 - (iii) When the wind is forecasted to be less than 1 kt, the forecasted wind speed shall be indicated as calm.
 - (iv) When the forecast maximum speed exceeds the forecasted mean wind speed by 10 kt or more, the forecasted maximum wind speed shall be indicated.
 - (v) When a wind speed of 100 kt or more is forecasted, it shall be indicated to be more than 99 kt.
- (2) Visibility
- (i) When the visibility is forecasted to be less than 800 m, it shall be expressed in steps of 50 m; when it is forecasted to be 800 m or more, but less than 5 km, in steps of 100 m; when it is forecasted to be 5 km or more, but less than 10 km, in kilometre steps; and when it is forecasted to be 10 km or more, it shall be expressed as 10 km, except when conditions of CAVOK are forecasted to apply. The prevailing visibility shall be forecasted.
 - (ii) When visibility is forecasted to vary in different directions and the prevailing visibility cannot be forecasted, the lowest forecasted visibility shall be given.
- (3) Weather phenomena
- (i) One or more, up to a maximum of three, of the following weather phenomena or combinations thereof, together with their characteristics and, where appropriate, intensity, shall be forecasted if they are expected to occur at the aerodrome:
 - (A) freezing precipitation;
 - (B) freezing fog;
 - (C) moderate or heavy precipitation (including showers thereof);
 - (D) low drifting dust, sand or snow;
 - (E) blowing dust, sand or snow;
 - (F) dust storm;
 - (G) sandstorm;
 - (H) thunderstorm (with or without precipitation);
 - (I) squall;
 - (J) funnel cloud (tornado or waterspout);
 - (K) other weather phenomena, as agreed by the aerodrome meteorological office with the ATS units and operators concerned.
 - (ii) The expected end of occurrence of those phenomena shall be indicated by the abbreviation 'NSW'.
- (4) Cloud
- (i) The cloud amount shall be forecast using the abbreviations 'FEW', 'SCT', 'BKN' or 'OVC', as necessary. When it is expected that the sky will remain or become

- obscured and clouds cannot be forecasted and information on vertical visibility is available at the aerodrome, the vertical visibility shall be forecasted in the form 'VV' followed by the forecasted value of the vertical visibility.
- (ii) When several layers or masses of cloud are forecasted, their amount and height of base shall be included in the following order:
- (A) the lowest layer or mass regardless of amount, to be forecasted as FEW, SCT, BKN or OVC as appropriate;
 - (B) the next layer or mass covering more than 2/8, to be forecast as SCT, BKN or OVC as appropriate;
 - (C) the next higher layer or mass covering more than 4/8, to be forecast as BKN or OVC as appropriate;
 - (D) cumulonimbus clouds and/or towering cumulus clouds, whenever forecasted and not already included under points (A) to (C).
- (iii) Cloud information shall be limited to cloud of operational significance; when no cloud of operational significance is forecasted and 'CAVOK' is not appropriate, the abbreviation 'NSC' shall be used.
- (f) Use of change groups
- (1) The criteria used for the inclusion of change groups in TAF or for the amendment of TAF shall be based on any of the following weather phenomena, or combinations thereof, being forecasted to begin or end or change in intensity:
 - (i) freezing fog;
 - (ii) freezing precipitation;
 - (iii) moderate or heavy precipitation (including showers thereof);
 - (iv) thunderstorm;
 - (v) dust storm;
 - (vi) sandstorm.
 - (2) When a change in any of the elements given in point (a) is required to be indicated, the change indicators 'BECMG' or 'TEMPO' shall be used followed by the time period during which the change is expected to occur. The time period shall be indicated as the beginning and end of the period in whole hours UTC. Only those elements for which a significant change is expected shall be included following a change indicator. However, in the case of significant changes in respect of cloud, all cloud groups, including layers or masses not expected to change, shall be indicated.
 - (3) The change indicator 'BECMG' and the associated time group shall be used to describe changes where the meteorological conditions are expected to reach or pass through specified threshold values at a regular or irregular rate and at an unspecified time during the time period. The time period shall not exceed 4 hours.
 - (4) The change indicator 'TEMPO' and the associated time group shall be used to describe expected frequent or infrequent temporary fluctuations in the meteorological conditions which reach or pass specified threshold values and last for a period of less than 1 hour in each instance and, in the aggregate, cover less than one half of the forecast period during which the fluctuations are expected to occur. If the temporary fluctuation is expected to

last 1 hour or longer, the change group 'BECMG' shall be used in accordance with point (3), or the validity period should be subdivided in accordance with point (5).

- (5) Where one set of prevailing weather conditions is expected to change significantly and more or less completely to a different set of conditions, the period of validity shall be subdivided into self-contained periods using the abbreviation 'FM' followed immediately by a six-figure time group in days, hours and minutes UTC indicating the time the change is expected to occur. The subdivided period following the abbreviation 'FM' shall be self-contained and all forecasted conditions given before the abbreviation shall be superseded by those following the abbreviation.
- (g) The probability of occurrence of an alternative value of a forecast element or elements shall be included when:
- (1) a 30 % or 40 % probability of alternative meteorological conditions exists during a specific forecast time period; or
 - (2) a 30 % or 40 % probability of temporary fluctuations in meteorological conditions exists during a specific forecast time period.

This shall be indicated in the TAF by using the abbreviation 'PROB' followed by the probability in tens of per cent and, in the case referred to in point (1), the time period during which the values are expected to apply, or in the case referred to in point (2), by using the abbreviation 'PROB' followed by the probability in tens of per cent, the change indicator 'TEMPO' and associated time group.

GM1 MET.TR.220 Aerodrome forecasts

ED Decision 2020/008/R

TAF — EXAMPLES

TAF for YUDO (Donlon/International)*:

TAF YUDO 152300Z 1600/1706 13010KT 9000 BKN025 BECMG 1606/1608 BKN014CB BKN020 TEMPO 1608/1612 17015G25KT 1000 TSRA BKN009CB BKN020 FM161230 15008KT 9999 BKN020

Meaning of the forecast:

TAF for Donlon/International* issued on the 15th of the month at 23.00 UTC valid from 00.00 UTC to 06.00 UTC on the 17th of the month; surface wind direction 130 degrees; wind speed 10 knots; visibility 9 kilometres, broken cloud at 2 500 feet; becoming between 06.00 UTC and 08.00 UTC on the 16th of the month, broken cumulonimbus cloud at 1 400 feet and broken cloud at 2 000 feet; temporarily between 08.00 UTC and 12.00 UTC on the 16th of the month surface wind direction 170 degrees; wind speed 15 knots gusting to 25 knots; visibility 1 000 metres in a thunderstorm with moderate rain, broken cumulonimbus cloud at 900 feet and broken cloud at 2 000 feet; from 12.30 UTC on the 16th of the month, surface wind direction 150 degrees; wind speed 8 knots; visibility 10 kilometres or more; and broken cloud at 2 000 feet.

* Fictitious location

GM2 MET.TR.220 Aerodrome forecasts

ED Decision 2022/004/R

TAF — EXAMPLE OF CANCELLATION

Cancellation of TAF for YUDO (Donlon/International)*:

TAF AMD YUDO 161845Z 1618/1703 CNL

Meaning of the forecast:

Amended TAF for Donlon/International* issued on the 16th of the month at 18.45 UTC cancelling the previously issued TAF valid from 18.00 UTC on the 16th of the month to 03.00 UTC on the 17th of the month.

* Fictitious location

GM3 MET.TR.220 Aerodrome forecasts

ED Decision 2022/004/R

TAF — ACCURACY

The accuracy of TAF should be monitored using appropriate verification methodologies as agreed with the competent authority. The verification should identify the accuracy of the forecast against the required change criteria for the forecast elements: wind direction, wind speed, visibility, precipitation, cloud amount, and cloud height. Where provided, maximum and minimum temperature forecasts in TAF should be verified.

GM1 MET.TR.220(a)(8) Aerodrome forecasts

ED Decision 2017/001/R

VISIBILITY

The visibility included in TAF refers to the forecast prevailing visibility.

AMC1 MET.TR.220(b) Aerodrome forecasts

ED Decision 2022/004/R

TAF — CODE FORM

TAF, and amendments thereto, should be encoded using:

- (a) the IWXXM GML form as specified in point (a) of [AMC1 MET.TR.115\(a\)](#); and
- (b) the alphanumeric code form for TAF as specified in point (b) of AMC1 MET.TR.115(a).

AMC1 MET.TR.220(c) Aerodrome forecasts

ED Decision 2022/004/R

PERIOD OF VALIDITY

- (a) The periods of validity for an up to 9-hour TAF should commence at 00, 03, 06, 09, 12, 15, 18 and 21 UTC and for a 24- and a 30-hour TAF at 00, 06, 12 and 18 UTC or 03, 09, 15, and 21 UTC.
- (b) The 24- and 30-hour TAF periods of validity should be determined based on the types of operations, as agreed between the aerodrome meteorological office and the operators concerned.

- (c) A routine TAF valid for up to 9 hours should be issued every 3 hours, and those valid for 24 or 30 hours should be issued every 6 hours.
- (d) If so agreed between the competent authority and the meteorological services provider, TAF valid for 24 or 30 hours may be issued every 3 hours, and the validity should commence at 00, 03, 06, 09, 12, 15, 18 and 21 UTC.
- (e) At aerodromes with limited hours of operation, the beginning of the period of validity of a TAF should commence at least 1 hour prior to the aerodrome resuming operations, or more as agreed between the aerodrome meteorological office and the operators concerned, to meet planning requirements for flights that arrive at the aerodromes as soon as it is opened for use.

GM1 MET.TR.220(e)(2)(i) Aerodrome forecasts

ED Decision 2022/004/R

TAF — PHENOMENA REDUCING VISIBILITY

When the visibility is forecast to be 5 000 m or less, the forecast weather phenomenon reducing visibility may be included in TAF, e.g. phenomena, and combinations thereof, such as FG, BR, HZ, -RA, -SN, etc.

AMC1 MET.TR.220(f) Aerodrome forecasts

ED Decision 2017/001/R

TAF — USE OF CHANGE GROUPS

The criteria used for the inclusion of change groups in TAF or amendments to TAF should be based on the following:

- (a) when the mean surface wind direction is forecasted to change by 60° or more, the mean speed before and/or after the change being 10 kt (5 m/s) or more;
- (b) when the mean surface wind speed is forecasted to change by 10 kt (5 m/s) or more;
- (c) when the variation from the mean surface wind speed (gusts) is forecasted to change by 10 kt (5 m/s) or more, the mean speed before and/or after the change being 15 kt (7.5 m/s) or more;
- (d) when the surface wind is forecasted to change through values of operational significance;
- (e) when the visibility is forecasted to improve and change to or pass through one or more of the following values, or when the visibility is forecasted to deteriorate and pass through one or more of the following values:
 - (1) 150, 350, 600, 800, 1 500 or 3 000 m; and
 - (2) 5 000 m in cases where significant numbers of flights are operated in accordance with the visual flight rules;
- (f) when any of the following weather phenomena, or combinations thereof, are forecasted to begin or end:
 - (1) low drifting dust, sand or snow;
 - (2) blowing dust, sand or snow;
 - (3) squall; and
 - (4) funnel cloud (tornado or waterspout);

- (g) when the height of base of the lowest layer or mass of cloud of BKN or OVC extent is forecasted to lift and change to or pass through one or more of the following values, or when the height of the lowest layer or mass of cloud of BKN or OVC extent is forecasted to lower and pass through one or more of the following values:
- (1) 100, 200, 500 or 1 000 ft (30, 60, 150 or 300 m); or
 - (2) 1 500 ft (450 m) in cases where significant numbers of flights are operated in accordance with the visual flight rules;
- (h) when the amount of a layer or mass of cloud below 1 500 ft (450 m) is forecasted to change:
- (1) from NSC, FEW or SCT to BKN or OVC; or
 - (2) from BKN or OVC to NSC, FEW or SCT;
- (i) when the vertical visibility is forecasted to improve and change to or pass through one or more of the following values, or when the vertical visibility is forecasted to deteriorate and pass through one or more of the following values: 100, 200, 500 or 1 000 ft (30, 60, 150 or 300 m); and
- (j) any other criteria based on local aerodrome operating minima, as agreed between the aerodrome meteorological office and the operators.

GM1 MET.TR.220(f)(1) Aerodrome forecasts

ED Decision 2022/004/R

TAF — USE OF CHANGE AND TIME INDICATORS

Guidance on the use of change and time indicators in TAF is given below:

Change or time indicator	Time period	Meaning
FM	$n_d n_d n_h n_h n_m n_m$	Used to indicate a significant change in most weather elements occurring at $n_d n_d$ day, $n_h n_h$ hours and $n_m n_m$ minutes (UTC); All the elements given before 'FM' are to be included following 'FM' (i.e. they are all superseded by those following the abbreviation).
BECMG	$n_{d1} n_{d1} n_{h1} n_{h1} / n_{d2} n_{d2} n_{h2} n_{h2}$	The change is forecast to commence at $n_{d1} n_{d1}$ day and $n_{h1} n_{h1}$ hours (UTC) and be completed by $n_{d2} n_{d2}$ day and $n_{h2} n_{h2}$ hours (UTC); Only those elements for which a change is forecast are to be given following 'BECMG'; The time period $n_{d1} n_{d1} n_{h1} n_{h1} / n_{d2} n_{d2} n_{h2} n_{h2}$ should normally be less than 2 hours and in any case should not exceed 4 hours.
TEMPO	$n_{d1} n_{d1} n_{h1} n_{h1} / n_{d2} n_{d2} n_{h2} n_{h2}$	Temporary fluctuations are forecast to commence at $n_{d1} n_{d1}$ day and $n_{h1} n_{h1}$ hours (UTC) and cease by $n_{d2} n_{d2}$ day and $n_{h2} n_{h2}$ hours (UTC); Only those elements for which fluctuations are forecast are to be given following 'TEMPO'; temporary

			fluctuations should last less than 1 hour in each instance, and in the aggregate, cover less than half of the period $n_{d1}n_{d1}n_{h1}n_{h1}/n_{d2}n_{d2}n_{h2}n_{h2}$.	
PROBnn	—	$n_{d1}n_{d1}n_{h1}n_{h1}/n_{d2}n_{d2}n_{h2}n_{h2}$	Probability of occurrence (in %) of an alternative value of a forecast element or elements; nn = 30 or nn = 40 only; To be placed after the element(s) concerned.	—
	TEMPO	$n_{d1}n_{d1}n_{h1}n_{h1}/n_{d2}n_{d2}n_{h2}n_{h2}$		Probability of occurrence of temporary fluctuations.

AMC1 MET.TR.220(g) Aerodrome forecasts

ED Decision 2017/001/R

USE OF PROBABILITY INDICATORS

- (a) The number of change and probability groups should be kept to a minimum.
- (b) The probability of occurrence of an alternative value of a forecast element or elements should be placed after the element or elements forecast and be followed by the alternative value of the element or elements.

GM1 MET.TR.220(g) Aerodrome forecasts

ED Decision 2017/001/R

USE OF PROBABILITY INDICATORS

- (a) A probability of an alternative value or change of less than 30 % should not be considered sufficiently significant to be indicated.
- (b) A probability of an alternative value or change of 50 % or more should not be considered a probability but, instead, should be indicated, as necessary, by use of the change indicators 'BECMG' or 'TEMPO' or by subdivision of the validity period using the abbreviation 'FM'. The probability group should neither be used to qualify the change indicator 'BECMG' nor the time indicator 'FM'.

MET.TR.225 Forecasts for landing

Regulation (EU) 2021/1338

- (a) TREND forecasts shall be issued in accordance with Appendix 1.
- (b) The units and scales used in the TREND forecast shall be the same as those used in the report to which it is appended.
- (c) The TREND forecast shall indicate significant changes in respect of one or more of the elements: surface wind, visibility, weather phenomena and clouds. Only those elements for which a significant change is expected shall be included. However, in the case of significant changes in respect of cloud, all cloud groups, including layers or masses not expected to change, shall be indicated. In the case of a significant change in visibility, the phenomenon causing the reduction of visibility shall also be indicated. When no change is expected to occur, this shall be indicated by the term 'NOSIG'.
 - (1) Surface wind

The TREND forecast shall indicate changes in the surface wind which involve:

- (i) a change in the mean wind direction of 60° or more, the mean speed before and/or after the change being 10 kt or more;
 - (ii) a change in mean wind speed of 10 kt or more
 - (iii) changes in the wind through values of operational significance.
- (2) Visibility
- (i) When the visibility is expected to improve and change to or pass through one or more of the following values, or when the visibility is expected to deteriorate and pass through one or more of the following values: 150, 350, 600, 800, 1 500 or 3 000 m, the TREND forecast shall indicate the change.
 - (ii) When significant numbers of flights are conducted in accordance with the visual flight rules, the forecast shall additionally indicate changes to or passing through 5 000 m.
 - (iii) In TREND forecasts appended to METAR and SPECI, visibility shall refer to the forecast prevailing visibility.
- (3) Weather phenomena
- (i) The TREND forecast shall indicate the expected onset, cessation or change in intensity of any of the following weather phenomena or combinations thereof:
 - (A) freezing precipitation;
 - (B) moderate or heavy precipitation, including showers thereof;
 - (C) thunderstorm, with precipitation;
 - (D) dust storm;
 - (E) sandstorm;
 - (F) other weather phenomena as agreed by the aerodrome meteorological office with the ATS units and operators concerned.
 - (ii) The TREND forecast shall indicate the expected onset or cessation of any of the following weather phenomena or combinations thereof:
 - (A) freezing fog;
 - (B) low drifting dust, sand or snow;
 - (C) blowing dust, sand or snow;
 - (D) thunderstorm (without precipitation);
 - (E) squall;
 - (F) funnel cloud (tornado or waterspout).
 - (iii) The total number of phenomena reported in points (i) and (ii) shall not exceed three.
 - (iv) The expected end of occurrence of the weather phenomena shall be indicated by the abbreviation 'NSW'.

(4) Clouds

- (i) When the height of base of a cloud layer of BKN or OVC extent is expected to lift and change to or pass through one or more of the following values, or when the height of base of a cloud layer of BKN or OVC extent is expected to lower and pass through one or more of the following values: 100, 200, 500, 1 000 and 1 500 ft (30, 60, 150, 300 and 450 m), the TREND forecast shall indicate the change.
- (ii) When the height of base of a cloud layer is below or is expected to fall below or rise above 1 500 ft (450 m), the TREND forecast shall also indicate changes in cloud amount from FEW, or SCT increasing to BKN or OVC, or changes from BKN or OVC decreasing to FEW or SCT.
- (iii) When no clouds of operational significance are forecast and 'CAVOK' is not appropriate, the abbreviation 'NSC' shall be used.

(5) Vertical visibility

When the sky is expected to remain or become obscured and vertical visibility observations are available at the aerodrome, and the vertical visibility is forecast to improve and change to or pass through one or more of the following values, or when the vertical visibility is forecast to deteriorate and pass through one or more of the following values: 100, 200, 500 or 1 000 ft (30, 60, 150 or 300 m), the TREND forecast shall indicate the change.

(6) Additional criteria

The aerodrome meteorological office and the users may agree on additional criteria to be used, based on local aerodrome operating minima.

(7) Use of change groups

- (i) When a change is expected to occur, the TREND forecast shall begin with one of the change indicators 'BECMG' or 'TEMPO'.
- (ii) The change indicator 'BECMG' shall be used to describe forecast changes where the meteorological conditions are expected to reach or pass through specified values at a regular or irregular rate. The period during which, or the time at which, the change is forecast to occur shall be indicated using the abbreviations 'FM', 'TL' or 'AT', as appropriate, each followed by a time group in hours and minutes.
- (iii) The change indicator 'TEMPO' shall be used to describe forecast temporary fluctuations in the meteorological conditions which reach or pass specified values and last for a period of less than 1 hour in each instance and, in the aggregate, cover less than one half of the period during which the fluctuations are forecast to occur. The period during which the temporary fluctuations are forecast to occur shall be indicated using the abbreviations 'FM' and/or 'TL', as appropriate, each followed by a time group in hours and minutes.

(8) Use of the probability indicator

The indicator 'PROB' shall not be used in TREND forecasts.

AMC1 MET.TR.225(c)(1)(iii) Forecasts for landing

ED Decision 2017/001/R

THRESHOLD VALUES

The threshold values should be established by the aerodrome meteorological office in consultation with the appropriate ATS units and operators concerned, taking into account changes in the wind which would:

- (a) require a change in runway(s) in use; and
- (b) indicate that the runway tailwind and crosswind components will change through values representing the main operating limits for typical aircraft operating at the aerodrome.

GM1 MET.TR.225(c)(2)(iii) Forecasts for landing

ED Decision 2020/008/R

VISIBILITY

In TREND forecasts appended to local routine report and local special report, visibility refers to the forecast visibility along the runway(s).

AMC1 MET.TR.225(c)(7)(ii) Forecasts for landing

ED Decision 2017/001/R

USE OF CHANGE GROUPS — BECMG

- (a) When the change is forecast to begin and end wholly within the trend forecast period, the beginning and end of the change should be indicated by using the abbreviations 'FM' and 'TL', respectively, with their associated time groups.
- (b) When the change is forecast to commence at the beginning of the trend forecast period but be completed before the end of that period, the abbreviation 'FM' and its associated time group should be omitted and only 'TL' and its associated time group should be used.
- (c) When the change is forecast to begin during the trend forecast period and be completed at the end of that period, the abbreviation 'TL' and its associated time group should be omitted and only 'FM' and its associated time group should be used.
- (d) When the change is forecast to occur at a specified time during the trend forecast period, the abbreviation 'AT' followed by its associated time group should be used.
- (e) When the change is forecast to commence at the beginning of the trend forecast period and be completed by the end of that period, or when the change is forecast to occur within the trend forecast period but the time is uncertain, the abbreviations 'FM', 'TL' or 'AT' and their associated time groups should be omitted and the change indicator 'BECMG' should be used alone.

GM1 MET.TR.225(c)(7)(ii) Forecasts for landing

ED Decision 2022/004/R

TREND FORECASTS — USE OF CHANGE INDICATORS

Guidance on the use of change indicators in trend forecasts is given in the table below.

Change indicator	Time indicator and period	Meaning	
NOSIG	—	no significant changes are forecast	
BECMG	FM _{n₁n₁n₁n₁} TL _{n₂n₂n₂n₂}	the change is forecast to	commence at _{n₁n₁n₁n₁} UTC and be completed by _{n₂n₂n₂n₂} UTC
	TL _{nnnn}		commence at the beginning of the trend forecast period and be completed by _{nnnn} UTC
	FM _{nnnn}		commence at _{nnnn} UTC and be completed by the end of the trend forecast period
	AT _{nnnn}		occur at _{nnnn} UTC (specified time)
	—		commence at the beginning of the trend forecast period and be completed by the end of the trend forecast period; or the time is uncertain
TEMPO	FM _{n₁n₁n₁n₁} TL _{n₂n₂n₂n₂}	temporary fluctuations are forecast to	commence at _{n₁n₁n₁n₁} UTC and cease by _{n₂n₂n₂n₂} UTC
	TL _{nnnn}		commence at the beginning of the trend forecast period and cease by _{nnnn} UTC
	FM _{nnnn}		commence at _{nnnn} UTC and cease by the end of the trend forecast period
	—		commence at the beginning of the trend forecast period and cease by the end of the trend forecast period

AMC1 MET.TR.225(c)(7)(iii) Forecasts for landing

ED Decision 2022/004/R

USE OF CHANGE GROUPS — TEMPO

- When the period of the temporary fluctuations in the meteorological conditions is forecast to begin and end wholly within the TREND forecast period, the beginning and end of the period of the temporary fluctuations should be indicated by using the abbreviations 'FM' and 'TL' respectively, with their associated time groups.
- When the period of the temporary fluctuations is forecast to commence at the beginning of the TREND forecast period but cease before the end of that period, the abbreviation 'FM' and its associated time group should be omitted and only 'TL' and its associated time group should be used.
- When the period of the temporary fluctuations is forecast to begin during the TREND forecast period and cease by the end of that period, the abbreviation 'TL' and its associated time group should be omitted and only 'FM' and its associated time group should be used.

- (d) When the period of the temporary fluctuations is forecast to commence at the beginning of the TREND forecast period and cease by the end of that period, both abbreviations 'FM' and 'TL' and their associated time groups should be omitted and the change indicator 'TEMPO' should be used alone.

MET.TR.230 Forecasts for take-off

Regulation (EU) 2017/373

- (a) A forecast for take-off shall refer to a specified period of time and shall contain information on expected conditions over the runway complex in regard to surface wind direction and speed and any variations thereof, temperature, pressure, and any other elements as agreed between the aerodrome meteorological office and the operators.
- (b) The order of the elements and the terminology, units and scales used in forecasts for take-off shall be the same as those used in reports for the same aerodrome.

AMC1 MET.TR.230(a) Forecasts for take-off

ED Decision 2017/001/R

AMENDMENTS TO FORECASTS

- (a) The criteria for the issuance of amendments to forecasts for take-off for surface wind direction and speed, temperature and pressure, and any other elements agreed locally should be agreed between the aerodrome meteorological office and the operators concerned.
- (b) The criteria should be consistent with the corresponding criteria for special reports established for the aerodrome.

MET.TR.235 Aerodrome warnings and wind shear warnings and alerts

Regulation (EU) 2021/1338

- (a) Wind shear warnings shall be issued in accordance with the template in Appendix 4.
- (b) The sequence number referred to in the template in Appendix 4 shall correspond to the number of wind shear warnings issued for the aerodrome since 00.01 UTC on the day concerned.
- (c) Wind shear alerts shall give concise, up-to-date information related to the observed existence of wind shear involving a headwind/tailwind change of 15 kt or more which could adversely affect aircraft on the final approach path or initial take-off path and aircraft on the runway during the landing roll or take-off run.
- (d) Wind shear alert shall, if practicable, relate to specific sections of the runway and distances along the approach path or take-off path as agreed between the aerodrome meteorological office, the appropriate ATS units and the operators concerned.

AMC1 MET.TR.235 Aerodrome warnings and wind shear warnings and alerts

ED Decision 2022/004/R

AERODROME WARNINGS — TEMPLATE FOR AERODROME WARNINGS

- (a) Aerodrome warnings should be issued in accordance with the template below or in another format where required by operators or aerodrome meteorological offices.

Template for aerodrome warnings			
Key: M = inclusion mandatory; C = inclusion conditional, included whenever applicable.			
Note 1: The ranges and resolutions for the numerical elements included in aerodrome warnings are provided in GM1 MET.TR.235 .			
Note 2: The row numbers in the 'Ref.' column are included only for clarity and ease of reference, and are not part of the aerodrome warning.			
Ref.	Element	Detailed content	Templates
1	Location indicator of the aerodrome (M)	Location indicator of the aerodrome	nnnn
2	Identification of the type of message (M)	Type of message and sequence number	AD WRNG [n]n
3	Validity period (M)	Day and time of validity period in UTC	VALID nnnnnn/nnnnnn
4	IF THE AERODROME WARNING IS TO BE CANCELLED, SEE DETAILS AT THE END OF THE TEMPLATE.		
5	Phenomenon (M)	Description of the phenomenon causing the issuance of the aerodrome warning	TC nnnnnnnnnn <i>or</i> [HVY] TS <i>or</i> GR <i>or</i> [HVY] SN [nnCM] <i>or</i> [HVY] FZRA <i>or</i> [HVY] FZDZ <i>or</i> RIME <i>or</i> [HVY] SS <i>or</i> [HVY] DS <i>or</i> SA <i>or</i> DU <i>or</i> SFC WSPD nn[n]KT MAX nn[n] <i>or</i> SFC WIND nnn/nn[n]KT MAX nn[n] <i>or</i> SQ <i>or</i> FROST <i>or</i> TSUNAMI <i>or</i> VA[DEPO] <i>or</i> TOX CHEM <i>or</i> Free text up to 32 characters
6	Observed or forecast phenomenon (M)	Indication whether the information is observed and expected to continue, <i>or</i> forecast	OBS [AT nnnnZ] <i>or</i> FCST
7	Changes in intensity (C)	Expected changes in intensity	INTSF <i>or</i> WKN <i>or</i> NC

OR

8	Cancellation of the aerodrome warning	Cancellation of the aerodrome warning referring to its identification	CNL AD WRNG [n]n nnnnnn/nnnnnn
---	---------------------------------------	---	-----------------------------------

- (b) When the above template is used, the sequence number referred to in the template should correspond to the number of aerodrome warnings issued for the aerodrome since 00.01 UTC on the day concerned.

GM1 MET.TR.235 Aerodrome warnings and wind shear warnings and alerts

ED Decision 2022/004/R

RANGES AND RESOLUTIONS — AERODROME WARNINGS

- (a) The ranges and resolutions for the numerical elements included in aerodrome warnings are shown below:

Ranges and resolutions for the numerical elements included in volcanic ash and tropical cyclone advisories, SIGMET, AIRMET, aerodrome and wind shear warnings

Note: The row numbers in the 'Ref.' column are included only for clarity and ease of reference, and are not part of the template.

Ref.	Elements	Range	Resolution
1	Summit elevation:	FT	000–27 000
		M	000–8 100
2	Advisory number:	for VA (index)*	000–2 000
		for TC (index)*	00–99
3	Maximum surface wind:	KT	00–199
4	Central pressure:	hPa	850–1 050
5	Surface wind speed:	KT	30–99
6	Surface visibility:	M	0000–0750
		M	0800–5 000
7	Cloud: height of base:	FT	000–1 000
8	Cloud: height of top:	FT	000–9 900
		FT	10 000–60 000
9	Latitudes:	° (degrees)	00–90
		(minutes)	00–60
10	Longitudes:	° (degrees)	000–180
		(minutes)	00–60
11	Flight levels:		000–650
12	Movement:	KT	0–150
		KMH	0–300

* Non-dimensional

- (b) The explanations for the abbreviations can be found in ICAO Doc 8400 'Procedures for Air Navigation Services — ICAO Abbreviations and Codes (PANS-ABC)'.

GM2 MET.TR.235 Aerodrome warnings and wind shear warnings and alerts

ED Decision 2022/004/R

AERODROME WARNINGS — EXAMPLES OF ELEMENTS

Non-exhaustive examples of the different elements used in the formulation of aerodrome warnings are provided below.

Aerodrome warning — examples of elements

Note 1: Consult the ‘aerodrome warning’ template in [AMC1 MET.TR.235](#) to identify the mandatory (M), the conditional (C) or the optional (O) elements.

Note 2: The ranges and resolutions for the numerical elements included in aerodrome warnings are provided in [GM1 MET.TR.235](#).

Note 3: The row numbers in the ‘Ref.’ column are included only for clarity and ease of reference, and are not part of the aerodrome warning. They do not correlate with the ‘Ref.’ column in [AMC1 MET.TR.235](#). Refer to the ‘Element’ column when cross-referencing.

Ref.	Element	Examples
1	Location indicator of the aerodrome	YUCC
2	Identification of the type of message	AD WRNG 2
3	Validity period	VALID 211230/211530
4	IF THE AERODROME WARNING IS TO BE CANCELLED, SEE DETAILS AT THE END OF THE TEMPLATE.	
5	Phenomenon	TC ANDREW HVY SN 25CM SFC WSPD 40KT MAX 60 SFC WIND 230/40KT VA TSUNAMI
6	Observed or forecast phenomenon	OBS AT 1200Z OBS
7	Changes in intensity	WKN
OR		
8	Cancellation of the aerodrome warning	CNL AD WRNG 2 211230/211530

GM3 MET.TR.235 Aerodrome warnings and wind shear warnings and alerts

ED Decision 2022/004/R

Phenomenon (M) — TOX CHEM

When issuing an aerodrome warning due to information related to toxic chemical affecting an aerodrome and or volcanic ash deposition, the warning should be filed by means of the use of free text up to 32 characters, e.g. TOX CHEM FCST XXXX AIRPORT NEARBY WKN. (XXXX = ICAO Location Indicator)

AMC1 MET.TR.235(a) Aerodrome warnings and wind shear warnings and alerts

ED Decision 2020/008/R

AERODROME WARNINGS — FORMAT

- (a) The additional text should be prepared in abbreviated plain language using approved ICAO abbreviations and numerical values. If no ICAO-approved abbreviations are available, English plain language text should be used.
- (b) When quantitative criteria are necessary for the issuance of aerodrome warnings, the criteria used should be as agreed between the aerodrome meteorological office and the users concerned.

AMC1 MET.TR.235(c) Aerodrome warnings and wind shear warnings and alerts

ED Decision 2022/004/R

WIND SHEAR WARNINGS - FORMAT

- (a) The use of text in addition to the abbreviations listed in the template in Appendix 4 should be kept to a minimum. The additional text should be prepared in abbreviated plain language using ICAO-approved abbreviations and numerical values.
- (b) When an aircraft report is used to prepare a wind shear warning or to confirm a warning previously issued, the corresponding aircraft report, including the aircraft type, should be disseminated unchanged in accordance with the local arrangements to those concerned.

GM1 MET.TR.235(a) Aerodrome warnings and wind shear warnings and alerts

ED Decision 2020/008/R

WIND SHEAR TYPES

Following reported encounters by both arriving and departing aircraft, two different wind shear warnings may exist: one for arriving aircraft and one for departing aircraft.

GM2 MET.TR.235(a) Aerodrome warnings and wind shear warnings and alerts

ED Decision 2020/008/R

REPORTING THE INTENSITY OF WIND SHEAR

Specifications for reporting the intensity of wind shear are still under development. It is recognised, however, that pilots, when reporting wind shear, may use the qualifying terms ‘moderate’, ‘strong’ or ‘severe’, based to a large extent on their subjective assessment of the intensity of the wind shear encountered.

GM1 MET.TR.235(c) Aerodrome warnings and wind shear warnings and alerts

ED Decision 2020/008/R

DETECTION OF WIND SHEAR

Wind shear conditions are normally associated with the following phenomena:

- (a) thunderstorms, microbursts, funnel cloud, tornado or waterspout, and gust fronts;
- (b) frontal surfaces;
- (c) strong surface winds coupled with local topography;
- (d) sea breeze fronts;
- (e) mountain waves, including low-level rotors in the terminal area;
- (f) low-level temperature inversions.

GM1 MET.TR.235(d) Aerodrome warnings and wind shear warnings and alerts

ED Decision 2017/001/R

DISSEMINATION OF WIND SHEAR ALERTS

The wind shear alerts are disseminated from automated, ground-based, wind shear remote-sensing or detection equipment in accordance with local arrangements to those concerned.

CHAPTER 3 — TECHNICAL REQUIREMENTS FOR METEOROLOGICAL WATCH OFFICES

MET.TR.250 SIGMET

Regulation (EU) 2021/1338

- (a) SIGMET shall be issued in accordance with the template shown in Appendix 5.
- (b) SIGMET shall consist of three types:
 - (1) SIGMET for en-route weather phenomena other than volcanic ash or tropical cyclones;
 - (2) SIGMET for volcanic ash;
 - (3) SIGMET for tropical cyclones.
- (c) The sequence number of SIGMET shall consist of three characters comprising one letter and two numbers.
- (d) Only one of the phenomena listed in Appendix 5 shall be included in a SIGMET, using the appropriate abbreviations and the following threshold value of surface wind speed of 34 kt or more for tropical cyclones.
- (e) SIGMET concerning thunderstorms or a tropical cyclone shall not include references to associated turbulence and icing.

AMC1 MET.TR.250(a) SIGMET

ED Decision 2020/008/R

AIRSPACE

In cases where the airspace is divided into a flight information region (FIR) and an upper-flight information region (UIR), the SIGMET should be identified by the location indicator of the ATS unit serving the FIR.

AMC2 MET.TR.250(a) SIGMET

ED Decision 2022/004/R

SIGMET — CODE FORM

SIGMET, and cancellations thereof, should be encoded using:

- (a) the IWXXM GML form as specified in point (a) of [AMC1 MET.TR.115\(a\)](#);
- (b) abbreviated plain language as specified in point (c) of [AMC1 MET.TR.115\(a\)](#).

AMC3 MET.TR.250(a) SIGMET

ED Decision 2022/004/R

FORMAT

SIGMET, when issued in graphical format, should be as specified below:

(a) SIGMET FOR TROPICAL CYCLONE — MODEL STC

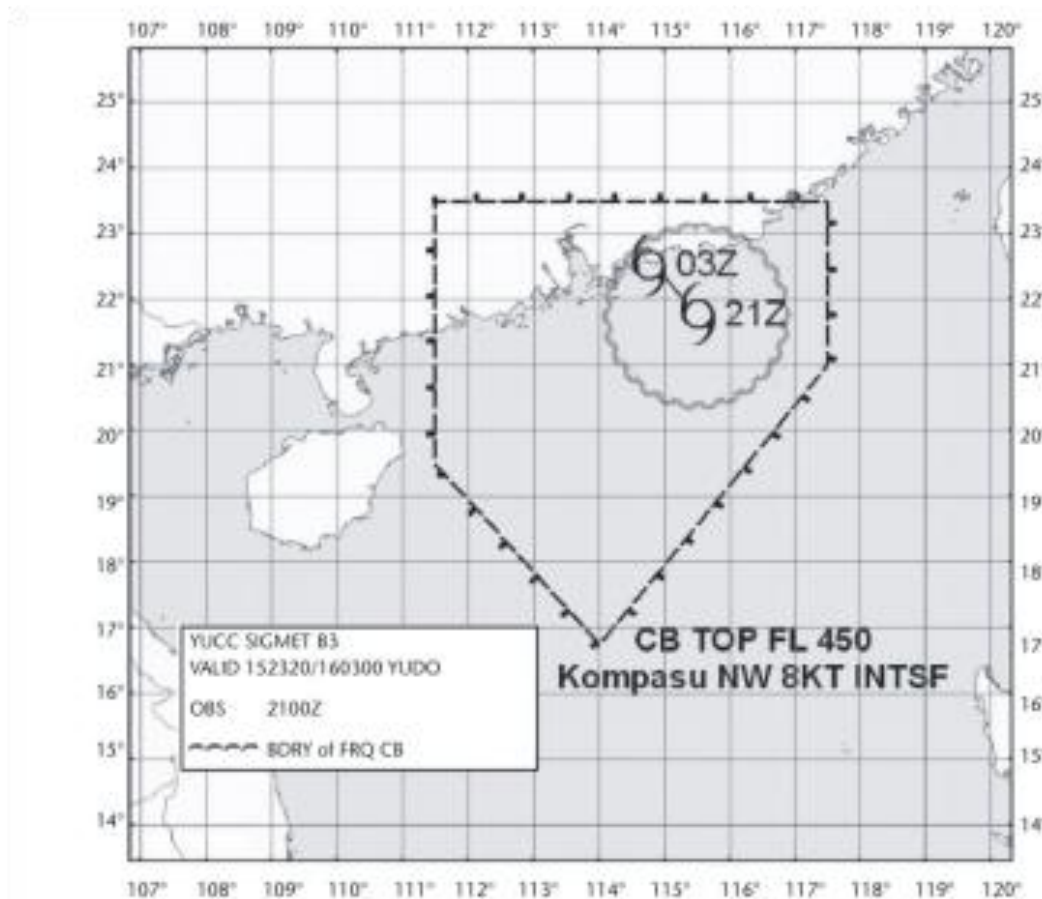

Note:  Fictitious FIR.

(b) SIGMET FOR VOLCANIC ASH — MODEL SVA, MERCATOR PROJECTION

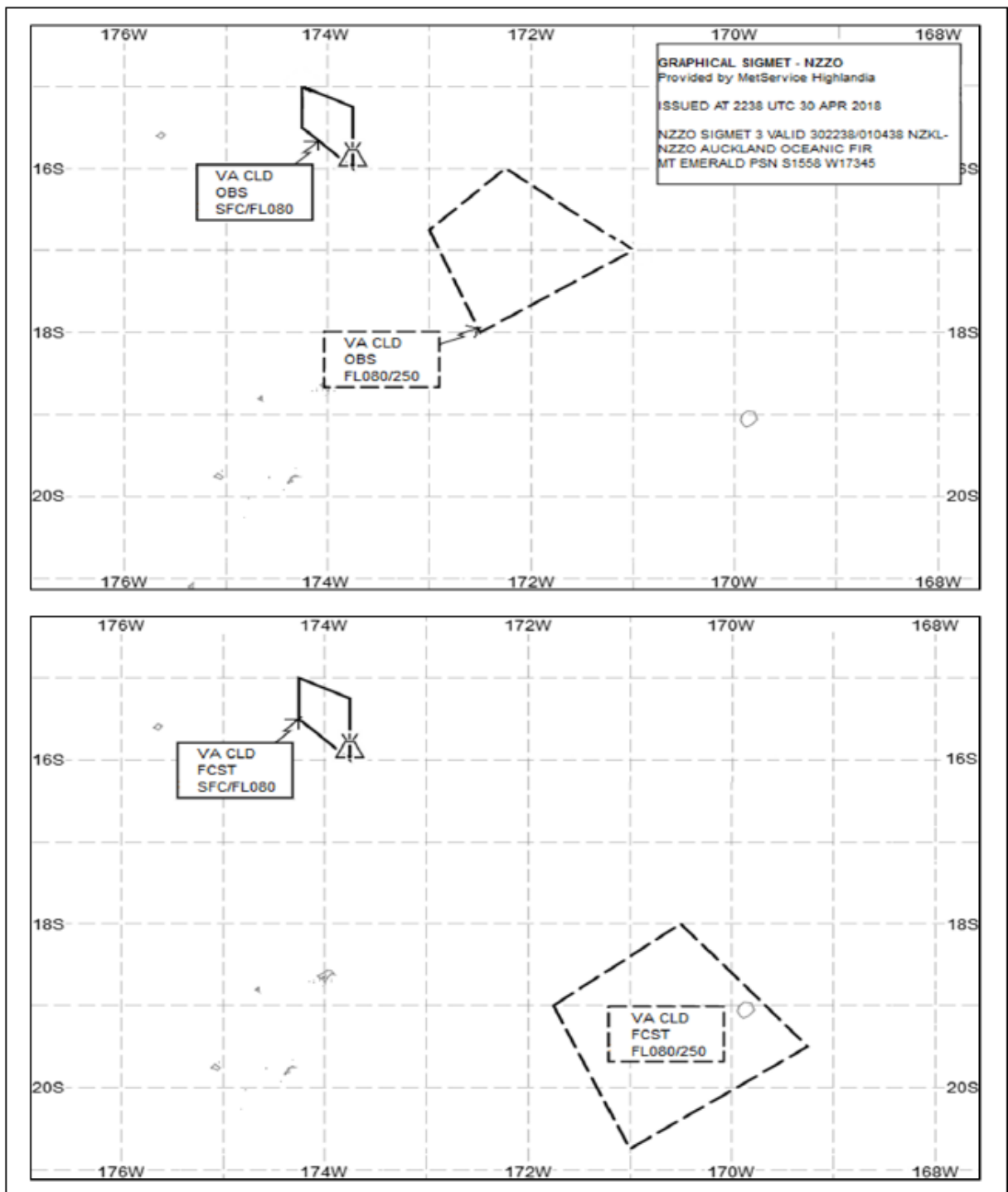

(c) SIGMET FOR VOLCANIC ASH — MODEL SVA, POLAR STEREOGRAPHIC PROJECTION

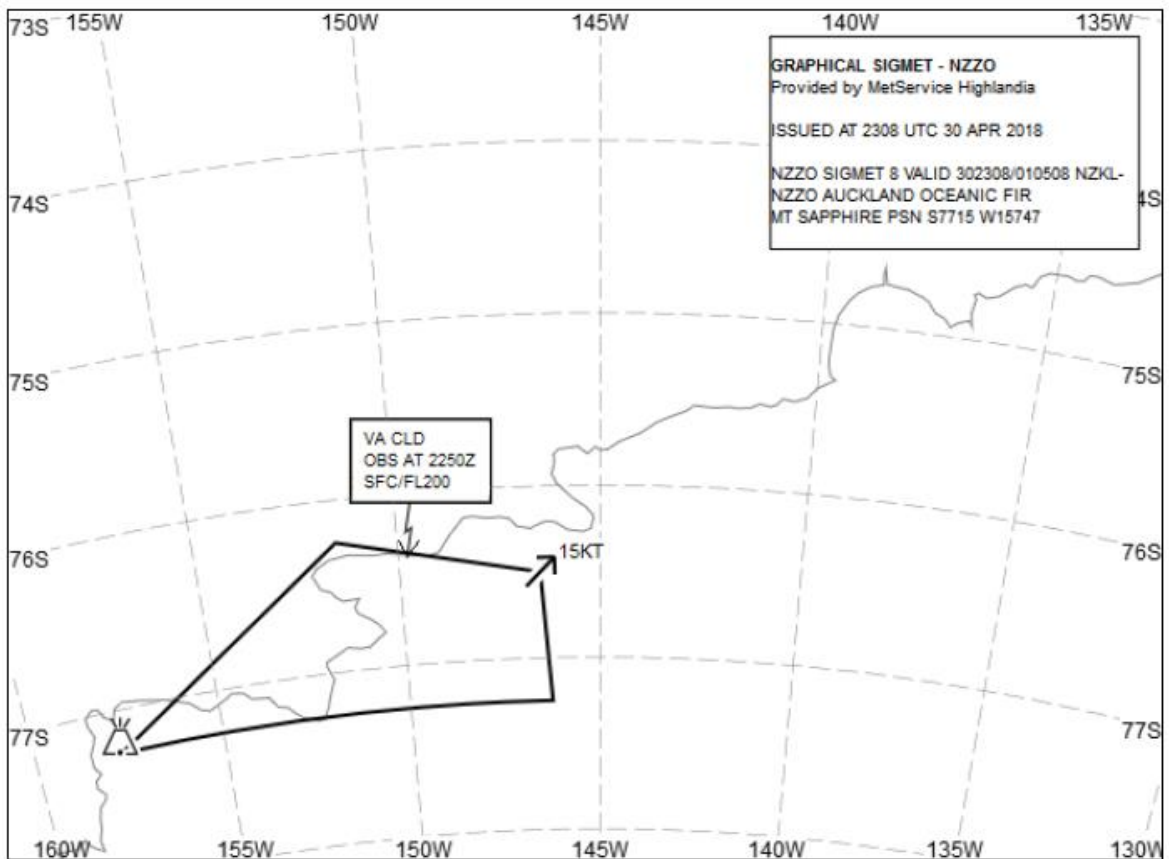

(d) SIGMET FOR PHENOMENA OTHER THAN TROPICAL CYCLONES AND VOLCANIC ASH — MODEL SGE

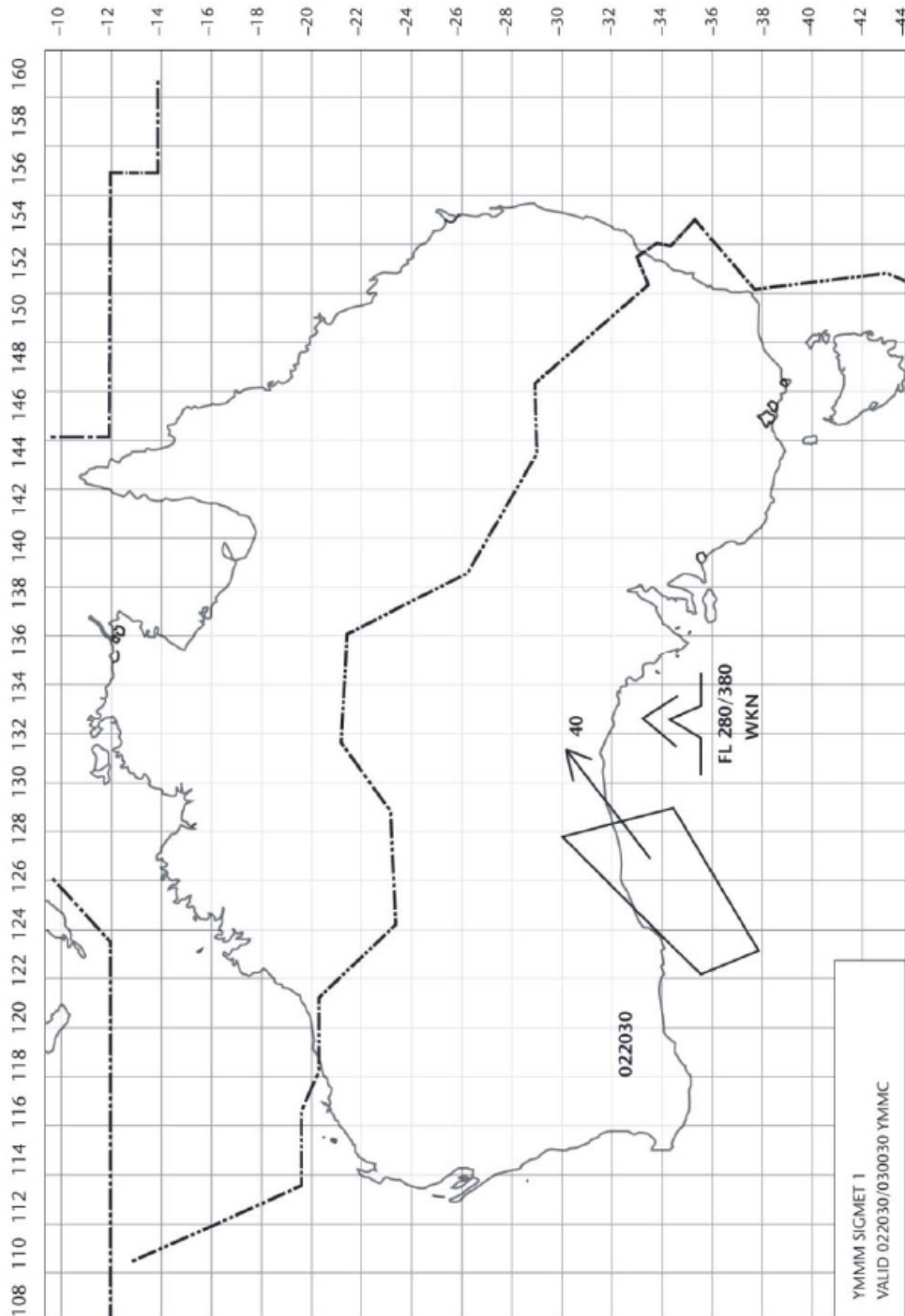

AMC4 MET.TR.250(a) SIGMET

ED Decision 2022/004/R

COORDINATION WITH NEIGHBOURING METEOROLOGICAL WATCH OFFICES (MWOs)

An MWO should coordinate SIGMET with neighbouring MWO(s), especially when the en-route weather phenomenon extends or is expected to extend beyond the MWO's specified area of responsibility, to ensure harmonised SIGMET provision.

GM1 MET.TR.250(a) SIGMET

ED Decision 2020/008/R

FLIGHT INFORMATION REGION

The SIGMET applies to the whole airspace within the lateral limits of the FIR, i.e. to the FIR and to the UIR. The particular areas and/or flight levels affected by the meteorological phenomena causing the issuance of the SIGMET are given in the text of the message.

GM2 MET.TR.250(a) SIGMET

ED Decision 2020/008/R

EXAMPLE OF SIGMET, AND THE CORRESPONDING CANCELLATIONS

SIGMET

YUDD SIGMET T02 VALID 101200/101600 YUSO–

YUDD SHANLON FIR/UIR OBSC TS FCST S OF N54 AND E OF W012 TOP FL390 MOV E 20 KT WKN

Cancellation of SIGMET

YUDD SIGMET T03 VALID 101345/101600 YUSO–

YUDD SHANLON FIR/UIR CNL SIGMET T02 101200/101600

GM3 MET.TR.250(a) SIGMET

ED Decision 2020/008/R

EXAMPLE OF SIGMET FOR TROPICAL CYCLONE

YUCC SIGMET CO3 VALID 251600/252200 YUDO —

YUCC AMSWELL FIR TC GLORIA PSN N2706 W07306 CB OBS AT 1600Z WI 250NM OF TC CENTRE TOP FL500 NC FCST AT 2200Z TC CENTRE PSN N2740 W07345

Meaning:

The third tropical cyclone SIGMET issued for the AMSWELL* flight information region (identified by YUCC Amwell area control centre) by the Donlon/International* meteorological watch office (YUDO) since 0001 UTC; the SIGMET is valid from 16.00 UTC to 22.00 UTC on the 25th of the month; tropical cyclone Gloria at 27 degrees 6 minutes north and 73 degrees 6 minutes west; cumulonimbus was observed at 16.00 UTC within 250 nautical miles of the centre of the tropical cyclone with top at flight level 500; no changes in intensity are expected; at 22.00 UTC, the centre of the tropical cyclone is forecast to be located at 27 degrees 40 minutes north and 73 degrees 45 minutes west

* Fictitious locations

GM4 MET.TR.250(a) SIGMET

ED Decision 2020/008/R

EXAMPLE OF SIGMET FOR VOLCANIC ASH

YUDD SIGMET AO2 VALID 101200/101800 YUSO—

YUDD SHANLON FIR VA ERUPTION MT ASHVAL PSN N4315 E02115 VA CLD OBS AT 1200Z WI N4315 E02115 - N4345 E02145 - N4330 E02215 - N4245 E02230 - N4230 E02145 - N4315 E02115 FL250/370 WKN FCST AT 1800Z NO VA EXP=

Meaning:

The second volcanic ash SIGMET issued for the SHANLON* flight information region (identified by YUDD Shanlon area control centre/upper flight information region) by the Shanlon/International* meteorological watch office (YUSO) since 00.01 UTC; the SIGMET is valid from 12.00 UTC to 18.00 UTC on the 10th of the month; volcanic ash eruption of Mount Ashval* located at 43 degrees 15 minutes north and 21 degrees 15 minutes east; volcanic ash cloud observed at 12.00 UTC within an area bounded by 43 degrees 15 minutes north and 21 degrees 15 minutes east to 43 degrees 30 minutes north and 22 degrees 15 minutes east to 42 degrees 45 minutes north and 22 degrees 30 minutes east to 42 degrees 30 minutes north and 21 degrees 45 minutes east to 43 degrees 15 minutes north and 21 degrees 15 minutes east between flight levels 250 and 370, weakening, and forecast at 18.00 UTC to have dissipated with no volcanic ash expected.

* Fictitious locations

GM5 MET.TR.250(a) SIGMET

ED Decision 2022/004/R

EXAMPLE OF SIGMET FOR RADIOACTIVE CLOUD

YUCC SIGMET RO2 VALID 201200/201600 YUDO —

YUCC AMSWELL FIR RDOACT CLD OBS AT 1155Z WI 30KM OF N6030 E02550 SFC/FL550 STNR

Meaning:

The second radioactive cloud SIGMET issued for the AMSWELL* flight information region (identified by YUCC Amwell area control centre) by the Donlon/International* meteorological watch office (YUDO) since 0001 UTC; the SIGMET is valid from 12.00 UTC to 16.00 UTC on the 20th of the month; radioactive cloud was observed at 1155 UTC within 30 kilometres of 60 degrees 30 minutes north 25 degrees 50 minutes east between the surface and flight level 550. The radioactive cloud is stationary.

* Fictitious locations

GM6 MET.TR.250(a) SIGMET

ED Decision 2020/008/R

EXAMPLE OF SIGMET FOR SEVERE TURBULENCE

YUCC SIGMET U05 VALID 221215/221600 YUDO—

YUCC AMSWELL FIR SEV TURB OBS AT 1210Z N2020 W07005 FL250 MOV E 20KT WKN FCST 1600Z S OF N2020 E OF W06950

Meaning:

The fifth severe turbulence SIGMET issued for the AMSWELL* flight information region (identified by YUCC Amswell area control centre) by the Donlon/International* meteorological watch office (YUDO) since 0001 UTC; the SIGMET is valid from 12.15 UTC to 16.00 UTC on the 22nd of the month; severe turbulence was observed at 1210 UTC 20 degrees 20 minutes north and 70 degrees 5 minutes west at flight level 250; the turbulence is expected to move eastwards at 20 knots and to strengthen in intensity; at 16.00 UTC, the severe turbulence is forecast to be located south of 20 degrees 20 minutes north and east of 69 degrees 50 minutes west.

* Fictitious locations

GM7 MET.TR.250(a) SIGMET

ED Decision 2022/004/R

COORDINATION WITH NEIGHBOURING METEOROLOGICAL WATCH OFFICES (MWOs)

Guidance on the bilateral or multilateral coordination between MWOs of neighbouring States for the provision of SIGMET can be found in ICAO EUR Doc 014 'EUR SIGMET and AIRMET Guide'.

AMC1 MET.TR.250(c) SIGMET

ED Decision 2022/004/R

SEQUENCE NUMBER

- (a) The three-character sequence number should be constructed using a single letter identifying the phenomenon, followed by two numeric characters corresponding to the number of SIGMET issued for that phenomenon for the specified flight information region since 00.01 UTC on the day concerned.
- (b) The letters to be used as the first character for the SIGMET sequence number to indicate the specified en-route weather and other phenomena for which the SIGMET has been issued should be:

SIGMET Type	Specified en-route phenomena	Letter to be used in the sequence number for specified en-route phenomena
WC	Tropical cyclone	C
	<i>For WC exchange test purposes</i>	X
WV	Volcanic ash	A
	<i>For WV exchange test purposes</i>	Y
WS	Thunderstorm	T
	Turbulence	U
	Icing	I
	Freezing rain	F
	Mountain wave	M
	Dust storm	D
	Sandstorm	S
	Radioactive cloud	R
	<i>For WS exchange test purposes</i>	Z

- (c) When SIGMET is issued for test purposes ('TEST' status indicator used in the SIGMET), then the appropriate letter for exchange test purposes should be used, i.e. 'Y' for a TEST volcanic ash SIGMET. When SIGMET is issued for exercise purposes ('EXER' status indicator used in the SIGMET), then the letter chosen should correspond to that used under normal circumstances, i.e. 'A' for a SIGMET issued during a volcanic ash exercise.

AMC1 MET.TR.250(d) SIGMET

ED Decision 2020/008/R

CRITERIA RELATED TO PHENOMENA

Sandstorm/dust storm should be considered:

- (a) heavy whenever the visibility is below 200 m and the sky is obscured; and
- (b) moderate whenever the visibility is:
- (1) below 200 m and the sky is not obscured; or
 - (2) between 200 and 600 m.

GM1 MET.TR.250(d) SIGMET

ED Decision 2022/004/R

CRITERIA RELATED TO PHENOMENA

- (a) An area of thunderstorms and cumulonimbus clouds is considered:
- (1) obscured (OBSC) if it is obscured by haze or smoke or cannot be readily seen due to darkness;
 - (2) embedded (EMBD) if it is embedded within cloud layers and cannot be readily recognised;
 - (3) isolated (ISOL) if it consists of individual features which affect, or are forecast to affect, an area with a maximum spatial coverage less than 50 % of the area concerned (at a fixed time or during the period of validity); and
 - (4) occasional (OCNL) if it consists of well-separated features which affect, or are forecast to affect, an area with a maximum spatial coverage between 50 and 75 % of the area concerned (at a fixed time or during the period of validity).
- (b) An area of thunderstorms is considered frequent (FRQ) if within that area there is little or no separation between adjacent thunderstorms with a maximum spatial coverage greater than 75 % of the area affected, or forecast to be affected, by the phenomenon (at a fixed time or during the period of validity).
- (c) Squall line (SQL) indicates a thunderstorm along a line with little or no space between individual clouds.
- (d) Hail (GR) is used as a further description of the thunderstorm, as necessary.
- (e) Severe and moderate turbulence (TURB) refers only to: low-level turbulence associated with strong surface winds; rotor streaming; or turbulence whether in cloud or not (CAT). Turbulence is not used in connection with convective clouds.
- (f) Turbulence is considered:
- (1) severe whenever the peak value of the EDR equals or exceeds 0.45; and

- (2) moderate whenever the peak value of the EDR is equal to or above 0.20 and below 0.45.
- (g) Severe and moderate icing (ICE) refers to icing in other than convective clouds. Freezing rain (FZRA) should refer to severe icing conditions caused by freezing rain.
- (h) A mountain wave (MTW) is considered:
 - (1) severe whenever an accompanying downdraft of 600 ft/min (3.0 m/s) or more and/or severe turbulence is observed or forecast; and
 - (2) moderate whenever an accompanying downdraft of 350–600 ft/min (1.75–3.0 m/s) and/or moderate turbulence is observed or forecast.

MET.TR.255 AIRMET

Regulation (EU) 2021/1338

- (a) AIRMET shall be issued in accordance with the template shown in Appendix 5.
- (b) The sequence number referred to in the template in Appendix 5 shall correspond to the number of AIRMET issued for the flight information region since 00.01 UTC on the day concerned.
- (c) Only one of the phenomena in Appendix 5 shall be included in an AIRMET, using the appropriate abbreviations and the following threshold values, when the phenomenon is below flight level 100, or below flight level 150 in mountainous areas, or higher, where necessary:
 - (1) widespread surface wind speed above 30 kt with relevant direction and units;
 - (2) widespread areas affected by reduction of visibility to less than 5 000 m, including the weather phenomenon causing the reduction of visibility;
 - (3) widespread areas of broken or overcast cloud with height of base less than 1 000 ft above ground level’.
- (d) AIRMET concerning thunderstorms or cumulonimbus clouds shall not include references to associated turbulence and icing.

AMC1 MET.TR.255(a) AIRMET

ED Decision 2022/004/R

AIRMET — CODE FORM

AIRMET, and cancellations thereof, should be encoded using:

- (a) the IWXXM GML form as specified in point (a) of [AMC1 MET.TR.115\(a\)](#);
- (b) abbreviated plain language as specified in point (c) of [AMC1 MET.TR.115\(a\)](#).

GM1 MET.TR.255(a) AIRMET

ED Decision 2020/008/R

EXAMPLE OF AIRMET FOR MODERATE MOUNTAIN WAVE

```
YUCC AIRMET 2 VALID 221215/221600 YUDO —  
YUCC AMSWELL FIR MOD MTW OBS AT 1205Z N48 E010 FL080 STNR NC  
Meaning:
```

The second AIRMET issued for the AMSWELL* flight information region (identified by YUCC Amwell area control centre) by the Donlon/International* meteorological watch office (YUDO) since 00.01 UTC; the AIRMET is valid from 12.15 UTC to 16.00 UTC on the 22nd of the month; moderate mountain wave was observed at 1205 UTC at 48 degrees north and 10 degrees east at flight level 080; the mountain wave is expected to remain stationary and not to undergo any changes in intensity.

* Fictitious locations

GM2 MET.TR.255(a) AIRMET

ED Decision 2020/008/R

EXAMPLE OF AIRMET, AND THE CORRESPONDING CANCELLATIONS

AIRMET

YUDD AIRMET 1 VALID 151520/151800 YUSO–

YUDD SHANLON FIR ISOL TS OBS N OF S50 TOP ABV FL100 STNR WKN

Cancellation of AIRMET

YUDD AIRMET 2 VALID 151650/151800 YUSO–

YUDD SHANLON FIR CNL AIRMET 1 151520/151800

GM1 MET.TR.255(b) AIRMET

ED Decision 2020/008/R

FIR

The flight information region may be divided in sub-areas.

GM1 MET.TR.255(c) AIRMET

ED Decision 2020/008/R

CRITERIA RELATED TO PHENOMENA

In reference to the criteria related to phenomena, please refer to [GM1 MET.TR.250\(d\)](#).

AMC1 MET.TR.255(d) AIRMET

ED Decision 2020/008/R

CRITERIA RELATED TO PHENOMENA

In reference to sandstorm/dust storm, please refer to [AMC1 MET.TR.250\(d\)](#).

MET.TR.260 Area forecasts for low-level flights

Regulation (EU) 2021/1338

- (a) When chart form is used for area forecasts for low-level flights, the forecast of upper wind and upper-air temperature shall be issued for points separated by no more than 300 NM and for, as a minimum, the following altitudes: 2 000, 5 000 and 10 000 ft (600, 1 500 and 3 000 m) and

15 000 ft (4 500 m) in mountainous areas. The issuance of forecasts of upper wind and upper-air temperature at an altitude of 2 000 ft (600 m) may be subject to local orographic considerations as determined by the competent authority.

- (b) When chart form is used for area forecasts for low-level flights, the forecast of SIGWX phenomena shall be issued as low-level SIGWX forecast for flight levels up to 100, or up to flight level 150 in mountainous areas, or higher, where necessary. Low-level SIGWX forecasts shall include:
 - (1) the following phenomena warranting the issuance of a SIGMET: severe icing, severe turbulence, cumulonimbus clouds and thunderstorms that are obscured, frequent, embedded or occurring at a squall line, sandstorms/dust storms and volcanic eruptions or a release of radioactive materials into the atmosphere, and which are expected to affect low-level flights;
 - (2) the following elements in area forecasts for low-level flights: surface wind, surface visibility, significant weather phenomena, mountain obscuration, cloud, icing, turbulence, mountain wave and height of zero-degree isotherm.
- (c) When the competent authority has determined that the density of traffic operating below flight level 100, or up to flight level 150 in mountainous areas, or higher, where necessary, warrants the issuance of an AIRMET in combination with area forecasts for low-level flights, the area forecasts shall be issued to cover the layer between the ground and flight level 100, or up to flight level 150 in mountainous areas, or higher, where necessary, and shall contain information on en-route weather phenomena hazardous to low-level flights.

AMC1 MET.TR.260 Area forecasts for low-level flights

ED Decision 2022/004/R

AMENDMENT OF AREA FORECASTS FOR LOW-LEVEL FLIGHTS

- (a) In case that an area forecast for low-level flights is not issued in combination with AIRMET, the criteria for amendments to the area forecast for low-level flights should as a minimum include the weather phenomena hazardous to low-level flights, which would otherwise constitute the criteria for the issuance of AIRMET.
- (b) When low-level forecast is issued as a SIGWX chart or as a wind and temperature (W+T) chart, it should, as appropriate, include the cloud/visibility information in the form of visibility/cloud base category which should be provided for well-defined sub-areas and/or route segments. For each sub-area and/or route segment, the reference height to which the cloud base information refers should be specified.
- (c) The graphical part of a SIGWX chart should depict the weather situation at the beginning of the validity period. Significant changes of initial weather parameters should be depicted together with time intervals determining the duration of expected changes.

CHAPTER 4 — TECHNICAL REQUIREMENTS FOR VOLCANIC ASH ADVISORY CENTRES (VAACs)

MET.TR.265 Volcanic ash advisory centre responsibilities

Regulation (EU) 2021/1338

The advisory information on volcanic ash shall be issued in accordance with the template shown in [Appendix 6](#). When no abbreviations are available, English plain language text, to be kept to a minimum, shall be used.

AMC1 MET.TR.265 Volcanic ash advisory centre responsibilities

ED Decision 2022/004/R

VOLCANIC ASH ADVISORY — CODE FORM

Volcanic ash advisory should be disseminated using:

- (a) the IWXXM GML form as specified in point (a) of [AMC1 MET.TR.115\(a\)](#);
- (b) abbreviated plain language as specified in point (c) of [AMC1 MET.TR.115\(a\)](#).

AMC2 MET.TR.265 Volcanic ash advisory centre responsibilities

ED Decision 2022/004/R

VOLCANIC ASH ADVISORY INFORMATION — GRAPHICAL FORMAT

The volcanic ash advisory information listed in Appendix 6 to Annex V (Part-MET) to Regulation (EU) 2017/373, when prepared in graphical format, should be as specified below and issued using the portable network graphics (PNG) format as specified in point (f) of [AMC1 MET.TR.115\(a\)](#):

Volcanic Ash Graphic (VAG)

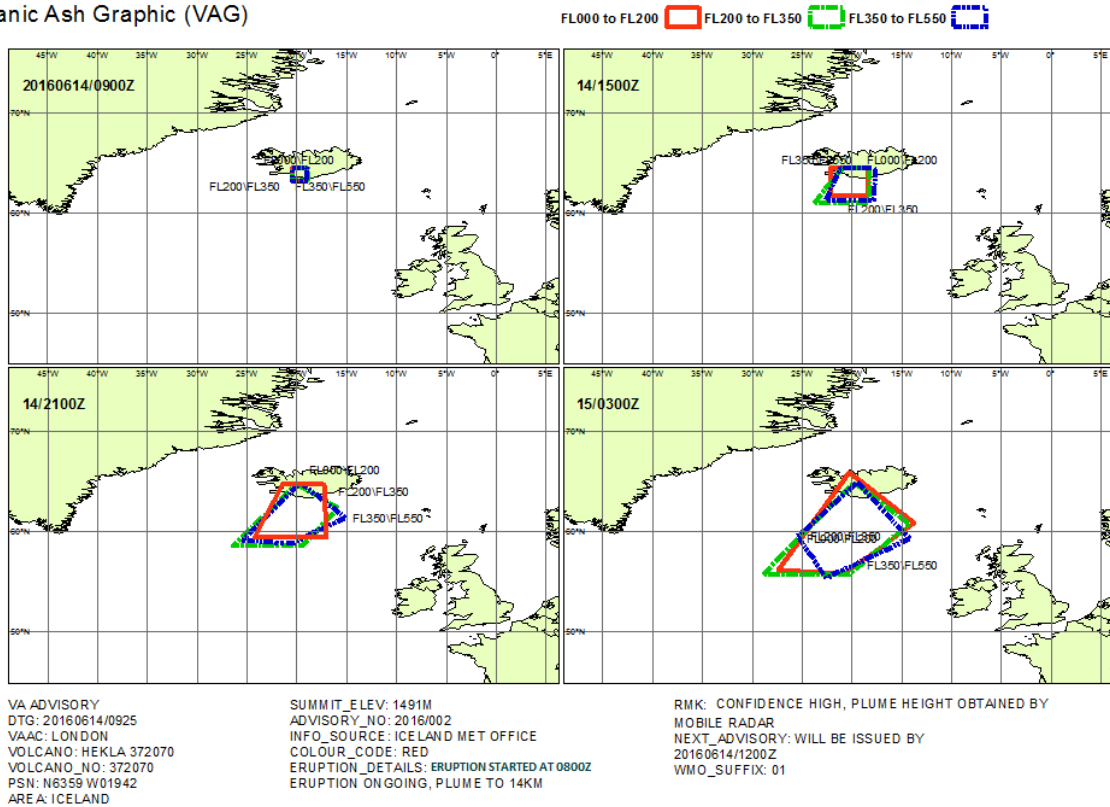

Example of volcanic ash advisory in graphical format from the London VAAC. Mercator projection.

Note: The example above is fictitious.

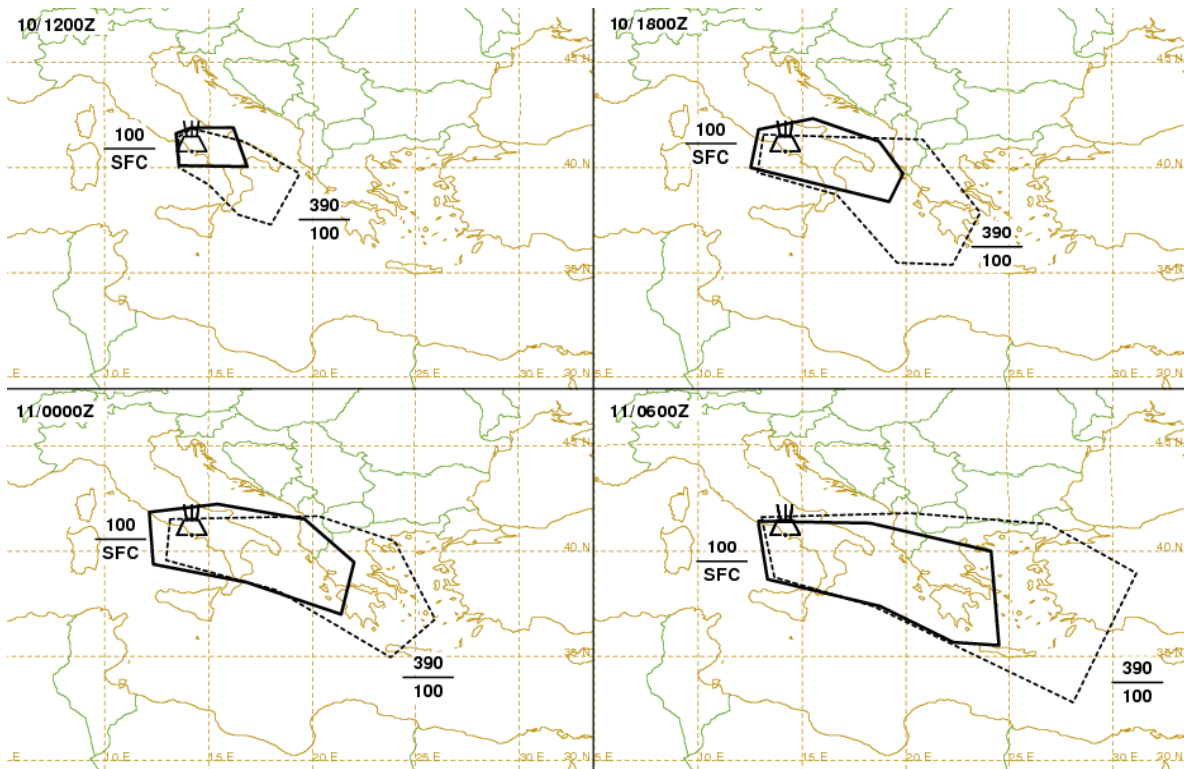

VOLCANIC ASH ADVISORY
DTG: 20171010/1200Z
VAAC: TOULOUSE
VOLCANO: CAMPI FLEGREI 211010
AREA: ITALY
SUMMIT ELEV: 458M



ADVISORY NR: 2017/03
INFO SOURCE: INGV
AVIATION COLOUR CODE: RED
ERUPTION DETAILS: THE VOLCANO ACTIVITY CONTINUES
RMK: VA CLD EVIDENT ON SATELLITE IMAGERY
NXT ADVISORY: NO FURTHER ADVISORY

Example of volcanic ash advisory in graphical format from the Toulouse VAAC. Mercator projection.

Note: The example above is fictitious.

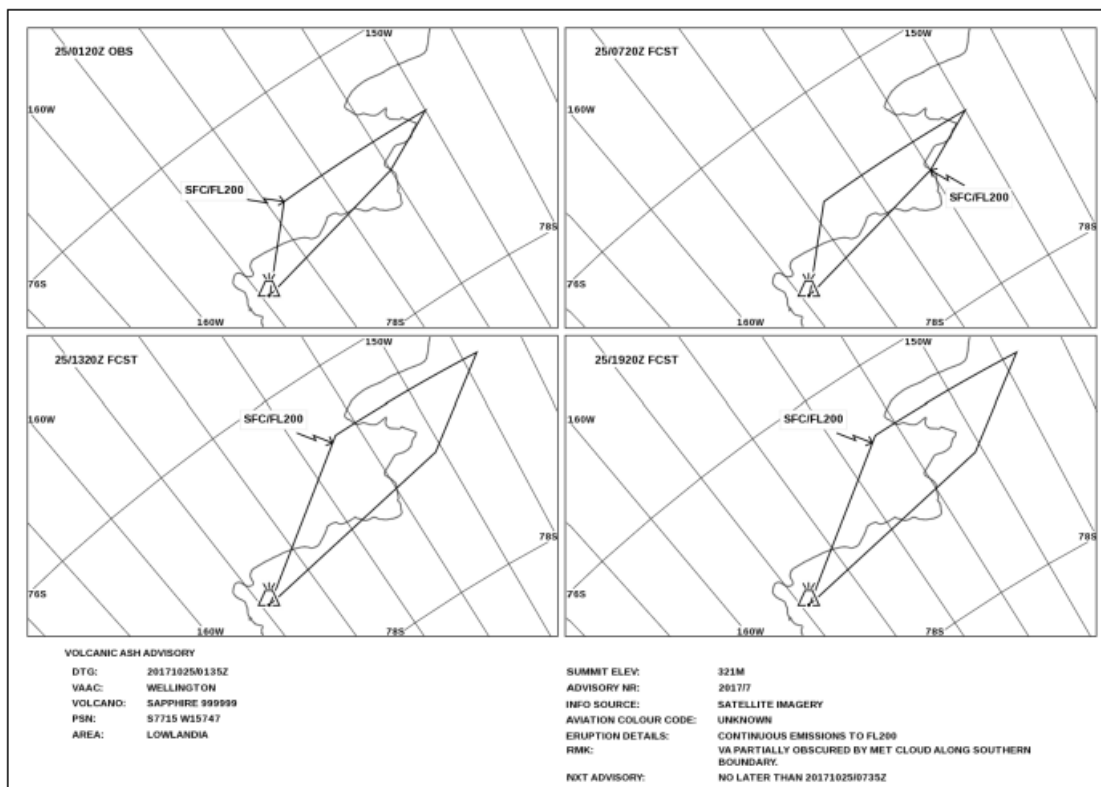

Example of volcanic ash advisory in graphical format from the Wellington VAAC. Polar stereographic projection.

Note: The example above is fictitious.

GM1 MET.TR.265 Volcanic ash advisory centre responsibilities

ED Decision 2022/004/R

EXAMPLES OF ADVISORY FOR VOLCANIC ASH

VA ADVISORY
DTG: 20160614/0925Z
VAAC: LONDON
VOLCANO: HEKLA 372070
PSN: N6359 W01942
AREA: ICELAND
SUMMIT ELEV: 1491M
ADVISORY NR: 2016/002
INFO SOURCE: ICELAND MET OFFICE
AVIATION COLOUR CODE: RED
ERUPTION DETAILS: ERUPTION STARTED AT 0600Z ONGOING, PLUME TO 14KM
OBS VA DTG: 14/0900Z

OBS VA CLD: SFC/FL200 N6421 W02030 - N6421 W01900 - N6315 W01856 -
N6303 W02025 - N6421 W02030 FL200/350 N6423 7W02021 - N6423
W01854 - N6309 W01856 - N6309 W02022 - N6423 W02021 FL350/550
N6422 W02023 - N6422 W01856 - N6304 W01854 - N6306 W02023 - N6422 W02023

FCST VA CLD +6HR: 14/1500Z SFC/FL200 N6423 W01822 - N6138 W01826 - N6135 W02205 - N6423
W02213 - N6423 W01822 FL200/350 N6425 W01814 - N6051 W01825 - N6050 W02348 - N6424
W02055 - N6425 W01814 FL350/550 N6419 W01737 - N6109 W01753 - N6116 W02234 - N6423
W02108 - N6419 W01737

FCST VA CLD +12HR: 14/2100Z SFC/FL200 N6449 W02121 - N6441 W01717 - N5921 W01659 - N5922
W02419 - N6449 W02121 FL200/350 N6441 W02002 - N6227 W01556 - N5831 W01927 - N5833
W02629 - N6441 W02002 FL350/550 N6448 W01941 - N6117 W01507 - N5846 W02024 - N5910
W02520 - N6448 W01941

FCST VA CLD +18HR: 15/0300Z SFC/FL200 N6554 W02018 - N6053 W01348 - N5542 W02046 - N5606
W02724 - N6554 W02018 FL200/350 N6446 W01949 - N6039 W01415 - N5535 W02019 - N5538
W02851 - N6446 W01949 FL350/550 N6500 W01928 - N5918 W01407 - N5516 W02235 - N5927
W02532 - N6500 W01928

RMK: T+0 CONFIDENCE HIGH, PLUME HEIGHT OBTAINED BY MOBILE RADAR

NXT ADVISORY: WILL BE ISSUED BY 20160614/1200Z

VA ADVISORY
VA ADVISORY
DTG: 20171010/1200Z
VAAC: TOULOUSE
VOLCANO: CAMPI FLEGREI 211010
PSN: N4049 E01408
AREA: ITALY
SUMMIT ELEV: 458M
ADVISORY NR: 2017/03
INFO SOURCE: INGV
AVIATION COLOUR CODE: RED
ERUPTION DETAILS: THE VOLCANO ACTIVITY CONTINUES
OBS VA DTG: 10/0600Z
OBS VA CLD: SFC/FL100 N4135 E01325 - N4155 E01410 - N4155 E01610 -
N4000 E01655 - N4005 E01335 - N4135 E01325 FL100/390 N4130 E01335 -
N4150 E01410 - N4115 E01645 - N3940 E01925 - N3715 E01800 - N3745

E01630 - N3910 E01500 - N4000 E01335 - N4130 E01335 MOV SE 20KT
FCST VA CLD +6HR: 10/1800Z SFC/FL100 N4150 E01255 - N4220 E01535 -
N4115 E01845 - N3940 E01955 - N3820 E01915 - N4000 E01235 - N4150
E01255 FL100/390 N4135 E01310 - N4120 E02050 - N3750 E02335 - N3520
E02215 - N3525 E01935 - N3840 E01640 - N3945 E01255 - N4135 E01310
FCST VA CLD +12HR: 11/0000Z SFC/FL100 N4150 E01210 - N4215 E01530 -
N4130 E01935 - N3925 E02200 - N3700 E02125 - N3830 E01650 - N3920
E01220 - N4150 E01210 FL100/390 N4130 E01310 - N4140 E02020 - N4030
E02400 - N3645 E02555 - N3455 E02350 - N3810 E01820 - N3935 E01255 -
N4130 E01310
FCST VA CLD +18HR: 11/0600Z SFC/FL100 N4125 E01255 - N4120 E01820 -
N4000 E02405 - N3530 E02430 - N3540 E02220 - N3725 E01845 - N3840
E01320 - N4115 E01255 - N4125 E01255 FL100/390 N4135 E01300 - N4145
E02010 - N4115 E02650 - N3900 E03105 - N3250 E02805 - N3720 E01830 -
N3845 E01340 - N4135 E01300
RMK: VA CLD EVIDENT ON SATELLITE IMAGERY
NXT ADVISORY: NO FURTHER ADVISORY

CHAPTER 5 — TECHNICAL REQUIREMENTS FOR TROPICAL CYCLONE ADVISORY CENTRES (TCACs)

MET.TR.270 Tropical cyclone advisory centre responsibilities

Regulation (EU) 2021/1338

The advisory information on tropical cyclones shall be issued in accordance with the template shown in [Appendix 7](#) for tropical cyclones when the maximum of the 10-minute mean surface wind speed is expected to reach or exceed 34 kt during the period covered by the advisory.

AMC1 MET.TR.270 Tropical cyclone advisory centre responsibilities

ED Decision 2022/004/R

TROPICAL CYCLONE ADVISORY — CODE FORM

Tropical cyclone advisory should be disseminated using:

- (a) the IWXXM GML form as specified in point (a) of [AMC1 MET.TR.115\(a\)](#);
- (b) abbreviated plain language as specified in point (c) of [AMC1 MET.TR.115\(a\)](#).

AMC2 MET.TR.270 Tropical cyclone advisory centre responsibilities

ED Decision 2022/004/R

TROPICAL CYCLONE ADVISORY — GRAPHICAL FORMAT

The tropical cyclone advisory information listed in [Appendix 7 to Annex V \(Part-MET\)](#) to Regulation (EU) 2017/373, when prepared in graphical format, should be as specified below and issued using the portable network graphics (PNG) format as specified in point (f) of [AMC1 MET.TR.115\(a\)](#):

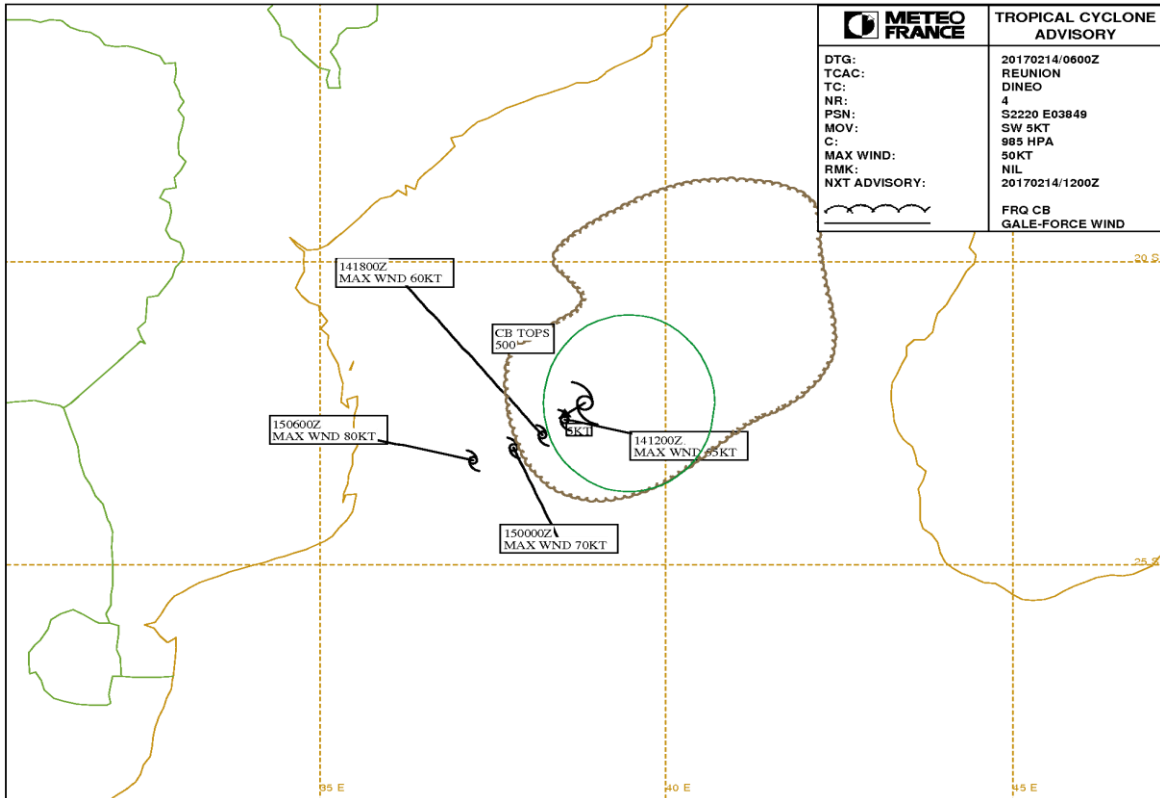

Example of tropical cyclone advisory in graphical format from the La Réunion TCAC.

Note: The example above is based on a real event.

GM1 MET.TR.270 Tropical cyclone advisory centre responsibilities

ED Decision 2022/004/R

ADVISORY FOR TROPICAL CYCLONES — EXAMPLE

TC ADVISORY
 DTG: 20170214/0600z
 TCAC: REUNION
 TC: DINEO
 ADVISORY NR: 2004/4
 OBS PSN: 14/0600Z S2220 E03849
 CB: WI 300NM OF TC CENTRE TOP FL500
 MOV: SW 05KT
 INTST CHANGE: INTSF
 C:985HPA
 MAX WIND:50KT
 FCST PSN +06HR:14/1200Z S2236 E03831
 FCST MAX WIND +06HR:55KT

FCST PSN +12HR:14/1800Z S2251 E03812

FCST MAX WIND +12HR:60KT

FCST PSN +18HR:15/0000Z S2304 E03748

FCST MAX WIND +18HR:70KT

FCST PSN +24HR:15/0600Z S2316 E03712

FCST MAX WIND +24HR:80KT

RMK:NIL

NXT MSG:20170214/1200Z

CHAPTER 6 — TECHNICAL REQUIREMENTS FOR WORLD AREA FORECAST CENTRES (WAFCS)

MET.TR.275 World area forecast centre responsibilities

Regulation (EU) 2021/1338

- (a) WAFCS shall use processed meteorological data in the form of grid point values for the supply of gridded global forecasts and forecasts of significant weather phenomena.
- (b) For global gridded forecasts, WAFCS shall:
- (1) prepare forecasts of:
 - (i) upper wind;
 - (ii) upper-air temperature;
 - (iii) humidity;
 - (iv) direction, speed and flight level of maximum wind;
 - (v) flight level and temperature of tropopause;
 - (vi) areas of cumulonimbus clouds;
 - (vii) icing;
 - (viii) turbulence;
 - (ix) geopotential altitude of flight levels;four times a day and be valid for fixed valid times at 6, 9, 12, 15, 18, 21, 24, 27, 30, 33 and 36 hours after the time (00.00, 06.00, 12.00 and 18.00 UTC) of the synoptic data on which the forecasts were based;
 - (2) issue forecasts referred to in point (1) and complete their dissemination as soon as technically feasible, but not later than 5 hours after standard time of observation;
 - (3) provide grid point forecasts in a regular grid comprising:
 - (i) wind data for flight levels 50 (850 hPa), 80 (750 hPa), 100 (700 hPa), 140 (600 hPa), 180 (500 hPa), 210 (450 hPa), 240 (400 hPa), 270 (350 hPa), 300 (300 hPa), 320 (275 hPa), 340 (250 hPa), 360 (225 hPa), 390 (200 hPa), 410 (175 hPa), 450 (150 hPa), 480 (125 hPa) and 530 (100 hPa) with a horizontal resolution of 1,25° of latitude and longitude;
 - (ii) temperature data for flight levels 50 (850 hPa), 80 (750 hPa), 100 (700 hPa), 140 (600 hPa), 180 (500 hPa), 210 (450 hPa), 240 (400 hPa), 270 (350 hPa), 300 (300 hPa), 320 (275 hPa), 340 (250 hPa), 360 (225 hPa), 390 (200 hPa), 410 (175 hPa), 450 (150 hPa), 480 (125 hPa) and 530 (100 hPa) with a horizontal resolution of 1,25° of latitude and longitude;
 - (iii) humidity data for flight levels 50 (850 hPa), 80 (750 hPa), 100 (700 hPa), 140 (600 hPa) and 180 (500 hPa) with a horizontal resolution of 1,25° of latitude and longitude;
 - (iv) geopotential altitude data for flight levels 50 (850 hPa), 80 (750 hPa), 100 (700 hPa), 140 (600 hPa), 180 (500 hPa), 210 (450 hPa), 240 (400 hPa), 270 (350 hPa),

- 300 (300 hPa), 320 (275 hPa), 340 (250 hPa), 360 (225 hPa), 390 (200 hPa), 410 (175 hPa), 450 (150 hPa) 480 (125 hPa) and 530 (100 hPa) with a horizontal resolution of 1,25° of latitude and longitude;
- (v) direction, speed and flight level of maximum wind with a horizontal resolution of 1,25° of latitude and longitude;
 - (vi) flight level and temperature of tropopause with a horizontal resolution of 1,25° of latitude and longitude;
 - (vii) icing for layers centred at flight levels 60 (800 hPa), 100 (700 hPa), 140 (600 hPa), 180 (500 hPa), 240 (400 hPa) and 300 (300 hPa) with a horizontal resolution of 0,25° of latitude and longitude;
 - (viii) turbulence for layers centred at flight levels 100 (700 hPa), 140 (600 hPa), 180 (500 hPa), 240 (400 hPa), 270 (350 hPa), 300 (300 hPa), 340 (250 hPa), 390 (200 hPa) and 450 (150 hPa) with a horizontal resolution of 0,25° of latitude and longitude;
 - (ix) horizontal extent and flight levels of base and top of cumulonimbus clouds with a horizontal resolution of 0,25° of latitude and longitude.
- (c) For global forecasts of en-route significant weather phenomena, WAFCs shall:
- (1) prepare SIGWX forecasts four times a day and shall be valid for fixed valid times at 24 hours after the time (00.00, 06.00, 12.00 and 18.00 UTC) of the synoptic data on which the forecasts were based. The dissemination of each forecast shall be completed as soon as technically feasible, but not later than 7 hours after standard time of observation under normal operations and not later than 9 hours after standard time of observation during backup operations;
 - (2) issue SIGWX forecasts as high-level SIGWX forecasts for flight levels between 250 and 630;
 - (3) include in SIGWX forecasts the following items:
 - (i) tropical cyclone provided that the maximum of the 10-minute mean surface wind speed is expected to reach or exceed 34 kt;
 - (ii) severe squall lines;
 - (iii) moderate or severe turbulence (in cloud or clear air);
 - (iv) moderate or severe icing;
 - (v) widespread sandstorm/dust storm;
 - (vi) cumulonimbus clouds associated with thunderstorms and with points (i) to (v);
 - (vii) non-convective cloud areas associated with in-cloud moderate or severe turbulence and/or moderate or severe icing;
 - (viii) flight level of tropopause;
 - (ix) jet streams;
 - (x) information on the location of volcanic eruptions that are producing ash clouds of significance to aircraft operations, comprising: volcanic eruption symbol at the location of the volcano and, in a separate text box on the chart, the volcanic eruption symbol, the name of the volcano, if known, and the latitude/longitude of

- the eruption. In addition, the legend of SIGWX charts should indicate ‘CHECK SIGMET, ADVISORIES FOR TC AND VA, AND ASHTAM AND NOTAM FOR VA’;
- (xi) information on the location of a release of radioactive materials into the atmosphere of significance to aircraft operations, comprising: the radioactive materials in the atmosphere symbol at the location of the release and, in a separate box on the chart, the radioactive materials in the atmosphere symbol, latitude/longitude of the site of the release and, if known, the name of the site of the radioactive source. In addition, the legend of SIGWX charts on which a release of radiation is indicated should contain ‘CHECK SIGMET AND NOTAM FOR RDOACT CLD’.
- (4) The following criteria shall be applied for SIGWX forecasts:
- (i) points (i) to (vi) of point (3) shall only be included if expected to occur between the lower and upper levels of the SIGWX forecast;
 - (ii) the abbreviation ‘CB’ shall only be included when it refers to the occurrence or expected occurrence of cumulonimbus clouds:
 - (A) affecting an area with a maximum spatial coverage of 50 % or more of the area concerned;
 - (B) along a line with little or no space between individual clouds; or
 - (C) embedded in cloud layers or concealed by haze;
 - (iii) the inclusion of ‘CB’ shall be understood to include all weather phenomena normally associated with cumulonimbus clouds, i.e. thunderstorm, moderate or severe icing, moderate or severe turbulence, and hail;
 - (iv) where a volcanic eruption or a release of radioactive materials into the atmosphere warrants the inclusion of the volcanic activity symbol or the radioactivity symbol in SIGWX forecasts, the symbols shall be included on SIGWX forecasts irrespective of the height to which the ash column or radioactive material is reported or expected to reach;
 - (v) in the case of coincident or the partial overlapping of points (i), (x) and (xi) of point (3), the highest priority shall be given to point (x), followed by points (xi) and (i). The point with the highest priority shall be placed at the location of the event, and an arrow shall be used to link the location of the other point(s) to its (their) associated symbol(s) or text box(es).
- (d) Medium-level SIGWX forecasts for flight levels between 100 and 450 for limited geographical areas shall be issued.

AMC1 MET.TR.275(a) World area forecast centres (WAFCs) responsibilities

ED Decision 2017/001/R

GRIDDED GLOBAL FORECASTS

The telecommunications facilities used for the supply of world area forecast system products should:

- (a) be the aeronautical fixed service or the public Internet;
- (b) be continuous; and
- (c) not have interruptions exceeding 10 minutes during any period of 6 hours.

AMC2 MET.TR.275(a) World area forecast centre responsibilities

ED Decision 2022/004/R

WORLD AREA FORECAST CENTRE GLOBAL GRIDDED FORECASTS — CODE FORM

World area forecast centre global gridded forecasts should be encoded using the GRIB code form as specified in point (d) of [AMC1 MET.TR.115\(a\)](#).

GM1 MET.TR.275(b)(3) World area forecast centre responsibilities

ED Decision 2022/004/R

GRID POINT FORECASTS

- (a) Layers centred at a flight level referred to in [MET.TR.275\(b\)\(3\)\(vii\)](#) have a depth of 100 hPa.
- (b) Layers centred at a flight level referred to in [MET.TR.275\(b\)\(3\)\(viii\)](#) have a depth of 100 hPa for flight levels below 240, then 50 hPa for flight levels 240 and above.

GM2 MET.TR.275(b)(3) World area forecast centre responsibilities

ED Decision 2022/004/R

GRID POINT FORECASTS

The turbulence referred to in [MET.TR.275\(b\)\(3\)\(viii\)](#) encompasses all types of turbulence, including clear-air turbulence and in-cloud turbulence.

GM3 MET.TR.275(b)(3) World area forecast centre responsibilities

ED Decision 2022/004/R

GRID POINT FORECASTS

The exact pressure levels (hPa) for [MET.TR.275\(b\)\(3\)](#) (i), (ii), (iii), (iv), (vii), and (viii) are provided in ICAO Doc 8896 'Manual of Aeronautical Meteorological Practice'.

AMC1 MET.TR.275(c) World area forecast centre responsibilities

ED Decision 2022/004/R

WORLD AREA FORECAST CENTRE (WAFC) GLOBAL FORECASTS OF SIGNIFICANT WEATHER — CODE FORM

World area forecast centre (WAFC) global forecasts of significant weather should be disseminated using:

- (a) the IWXXM GML form as specified in point (a) of [AMC1 MET.TR.115\(a\)](#);
- (b) the BUFR code form as specified in point (e) of [AMC1 MET.TR.115\(a\)](#).

AMC1 MET.TR.275(d) World area forecast centre responsibilities

ED Decision 2022/004/R

MEDIUM-LEVEL SIGWX FORECASTS

The medium-level SIGWX forecasts provided for flight levels between 100 and 450 for limited geographical areas should cover the areas as shown in [Appendix 2](#).

APPENDICES TO ANNEX V

Appendix 1

Regulation (EU) 2021/1338

Template for METAR and SPECI

Key:

M = inclusion mandatory;

C = inclusion conditional, dependent on meteorological conditions or method of observation;

O = inclusion optional.

Note 1: The ranges and resolutions for the numerical elements included in METAR and SPECI are provided in a separate table below this template.

Note 2: The explanations for the abbreviations can be found in ICAO Document 8400 Procedures for Air Navigation Services — Abbreviations and Codes (PANS-ABC).

Note 3: Row numbers in the 'Ref.' column are included only for clarity and ease of reference, and are not part of the METAR and SPECI.

Ref.	Element	Detailed content	Template(s)
1	Identification of the type of report (M)	Type of report (M)	METAR, METAR COR, SPECI or SPECI COR
2	Location indicator (M)	ICAO location indicator (M)	nnnn
3	Time of the observation (M)	Day and actual time of the observation in UTC (M)	nnnnnnZ
4	Identification of an automated or missing report (C)	Automated or missing report identifier (C)	AUTO or NIL
5	END OF METAR IF THE REPORT IS MISSING.		
6	Surface wind (M)	Wind direction (M)	nnn or /// ⁽¹⁾ VRB
		Wind speed (M)	[P]nn[n] or // ⁽²⁾
		Significant speed variations (C)	G[P]nn[n]
		Units of measurement (M)	KT
		Significant directional variations (C)	nnnVnnn —
7	Visibility (M)	Prevailing or minimum visibility (M)	nnnn or //// ⁽³⁾ C A V O K
		Minimum visibility and direction of the minimum visibility (C)	nnnn[N] or nnnn[NE] or nnnn[E] or nnnn[SE] or nnnn[S] or nnnn[SW] or nnnn[W] or nnnn[NW]

¹ When a meteorological element is temporarily missing, or its value is considered temporarily as incorrect, it is replaced by a solidus ('/')

² When a meteorological element is temporarily missing, or its value is considered temporarily as incorrect, it is replaced by a solidus ('/')

³ When a meteorological element is temporarily missing, or its value is considered temporarily as incorrect, it is replaced by a solidus ('/')

8	Runway visual range (C) ⁽¹⁾	Name of the element (M)	R		
		Runway (M)	nn[L]/or nn[C]/or nn[R]/		
		Runway visual range (M)	[P or M]nnnn or //// ⁽²¹⁾		
		Runway visual range past tendency (C)	U, D or N		
9	Present weather (C)	Intensity or proximity of present weather (C)	– or +	—	VC
		Characteristics and type of present weather (M)	DZ or RA or SN or SG or PL or DS or SS or FZDZ or FZRA or FZUP ⁽³⁾ or FC ⁽⁴⁾ or SHGR or SHGS or SHRA or SHSN or SHUP ⁽⁵⁾ or TSGR or TSGS or TSRA or TSSN or TSUP ⁽⁶⁾ or UP ⁽⁷⁾	FG or BR or SA or DU or HZ or FU or VA or SQ or PO or TS or BCFG or BLDU or BLSA or BLSN or DRDU or DRSA or DRSN or FZFG or MIFG or PRFG or // ⁽⁸⁾	FG or PO or FC or DS or SS or TS or SH or BLSN or BLSA or BLDU or VA

¹ To be included if the visibility or the runway visual range is < 1 500 m for up to a maximum of four runways.

² When a meteorological element is temporarily missing, or its value is considered temporarily as incorrect, it is replaced by a solidus ('/')

³ For automated reports only.

⁴ 'Heavy' is used to indicate 'tornado' or 'waterspout'; 'moderate' (no qualifier) to indicate 'funnel cloud not reaching the ground'.

⁵ For automated reports only.

⁶ For automated reports only.

⁷ For automated reports only.

⁸ When a meteorological element is temporarily missing, or its value is considered temporarily as incorrect, it is replaced by a solidus ('/')

10	Cloud (M)	Cloud amount and height of cloud base or vertical visibility (M)	FEWnnn or SCTnnn or BKNnnn or OVCnnn or FEW/// ⁽¹⁾ or SCT/// ⁽²⁾ or BKN/// ⁽³⁾ or OVC/// ⁽⁴⁾ or ///nnn ⁽⁵⁾ or ///// ⁽⁶⁾	VVnnn or VV/// ⁽⁷⁾	NSC or NCD ⁽⁸⁾
		Cloud type (C)	CB or TCU or /// ^{(9),(10)}	—	
11	Air and dew-point temperature (M)	Air and dew-point temperature (M)	[M]nn/[M]nn or ///[M]nn ⁽¹¹⁾ or [M]nn/// ⁽¹²⁾ or ///// ⁽¹³⁾		
12	Pressure values (M)	Name of the element (M)	Q		
		QNH (M)	nnnn or //// ⁽¹⁴⁾		

¹ When a meteorological element is temporarily missing, or its value is considered temporarily as incorrect, it is replaced by a solidus ('/')

² When a meteorological element is temporarily missing, or its value is considered temporarily as incorrect, it is replaced by a solidus ('/')

³ When a meteorological element is temporarily missing, or its value is considered temporarily as incorrect, it is replaced by a solidus ('/')

⁴ When a meteorological element is temporarily missing, or its value is considered temporarily as incorrect, it is replaced by a solidus ('/')

⁵ When a meteorological element is temporarily missing, or its value is considered temporarily as incorrect, it is replaced by a solidus ('/')

⁶ When a meteorological element is temporarily missing, or its value is considered temporarily as incorrect, it is replaced by a solidus ('/')

⁷ When a meteorological element is temporarily missing, or its value is considered temporarily as incorrect, it is replaced by a solidus ('/')

⁸ For automated reports only.

⁹ When a meteorological element is temporarily missing, or its value is considered temporarily as incorrect, it is replaced by a solidus ('/')

¹⁰ In the case of automated reports, solidi ('///') may replace the relevant cloud type, as appropriate, dependent on the capability of the automatic observing system. Furthermore, solidi may replace cloud amount and/or cloud height of reported CB or TCU layer.

¹¹ When a meteorological element is temporarily missing, or its value is considered temporarily as incorrect, it is replaced by a solidus ('/')

¹² When a meteorological element is temporarily missing, or its value is considered temporarily as incorrect, it is replaced by a solidus ('/')

¹³ When a meteorological element is temporarily missing, or its value is considered temporarily as incorrect, it is replaced by a solidus ('/')

¹⁴ When a meteorological element is temporarily missing, or its value is considered temporarily as incorrect, it is replaced by a solidus ('/')

13	Supplementary information (C)	Recent weather (C)	RERASN or REFZDZ or REFZRA or REDZ or RE[SH]RA or RE[SH]SN or RESG or RESHGR or RESHGS or REBLSN or RESS or REDS or RETSRA or RETSSN or RETSGR or RETSGS or RETS or REFC or REVA or REPL or REUP ⁽¹⁾ or REFZUP ⁽²⁾ or RETSUP ⁽³⁾ or RESHUP ⁽⁴⁾ or RE// ⁽⁵⁾				
		Wind shear (C)	WS Rnn[L] or WS Rnn[C] or WS Rnn[R] or WS ALL RWY				
		Sea-surface temperature and state of the sea or significant wave height (C)	W[M]nn/Sn or W///Sn ⁽⁶⁾ or W[M]nn/S/ ⁽⁷⁾ or W[M]nn/Hn[n][n] or W///Hn[n][n] ⁽⁸⁾ or W[M]nn/H/// ⁽⁹⁾				
14	Trend forecast (O)	Change indicator (M)	NOSIG	BECMG or TEMPO			C A V O K
		Period of change (C)		FMnnnn and/or TLnnnn or ATnnnn			
		Wind (C)		nnn[P]nn[G[P]nn]KT			
		Prevailing visibility (C)		nnnn			
		Weather phenomenon: intensity (C)		– or +	—	N S W	
		Weather phenomenon: characteristics and type (C)		DZ or RA or SN or SG or PL or DS or SS or FZDZ or FZRA or SHGR or SHGS or SHRA or SHSN or TSGR or TSGS or TSRA or TSSN	FG or BR or SA or DU or HZ or FU or VA or SQ or PO or FC or TS or BCFG or BLDU or BLSA or BLSN or DRDU or DRSA or DRSN or FZFG or MIFG or PRFG		

¹ For automated reports only.

² For automated reports only.

³ For automated reports only.

⁴ For automated reports only.

⁵ When a meteorological element is temporarily missing, or its value is considered temporarily as incorrect, it is replaced by a solidus ('/')

⁶ When a meteorological element is temporarily missing, or its value is considered temporarily as incorrect, it is replaced by a solidus ('/')

⁷ When a meteorological element is temporarily missing, or its value is considered temporarily as incorrect, it is replaced by a solidus ('/')

⁸ When a meteorological element is temporarily missing, or its value is considered temporarily as incorrect, it is replaced by a solidus ('/')

⁹ When a meteorological element is temporarily missing, or its value is considered temporarily as incorrect, it is replaced by a solidus ('/')

	Cloud amount and height of cloud base or vertical visibility (C)		FEWnnn or SCTnnn or BKNnnn or OVCnnn	VVnnn or VV///	N S C	
	Cloud type (C)		CB or TCU	—		

Ranges and resolutions for the numerical elements included in METAR and SPECI				
Ref.	Elements		Range	Resolution
1	Runway:	(no units)	01–36	1
2	Wind direction:	°true	000–360	10
3	Wind speed:	KT	00–99 P99	1 N/A (100 or greater)
4	Visibility:	M	0000–0750	50
		M	0800–4900	100
		M	5 000–9 000	1 000
		M	10 000 or greater	0 (fixed value: 9 999)
5	Runway visual range:	M	0000–0375	25
		M	0400–0750	50
		M	0800–2 000	100
6	Vertical visibility:	100's FT	000–020	1
7	Clouds: height of cloud base:	100's FT	000–099 100-200	1 10
8	Air temperature: Dew-point temperature:	°C	–80 – +60	1
9	QNH:	hPa	0850–1100	1
10	Sea-surface temperature:	°C	–10 – +40	1
11	State of the sea:	(no units)	0–9	1
12	Significant wave height:	M	0–999	0,1

GM1 to Appendix 1 ‘Template for METAR and SPECI’

ED Decision 2022/004/R

METAR AND SPECI — EXAMPLES OF ELEMENTS

Non-exhaustive examples of the different elements used in the formulation of METAR and SPECI are provided below.

METAR and SPECI — examples of elements

Note 1: Consult the ‘Template for METAR and SPECI’ ([Appendix 1 to Annex V \(Part-MET\)](#) to Regulation (EU) 2017/373) to identify the mandatory (M), the conditional (C) or the optional (O) elements.

Note 2: The ranges and resolutions for the numerical elements included in the METAR and SPECI are provided in [Appendix 1 to Annex V \(Part-MET\)](#) to Regulation (EU) 2017/373.

Note 3: The row numbers in the ‘Ref.’ column are included only for clarity and ease of reference, and are not part of the METAR and SPECI. They do not correlate with the ‘Ref.’ column in the ‘Template for METAR and SPECI’ in [Appendix 1 to Annex V \(Part-MET\)](#) to Regulation (EU) 2017/373. Refer to the ‘Element’ column when cross-referencing.

Ref.	Element	Examples
1	Identification of the type of report	METAR METAR COR SPECI
2	ICAO location indicator	YUDO
3	Time of the observation	221630Z
4	Identification of an automated report or a missing report	AUTO NIL
5	Surface wind	24008KT VRB02KT 19012KT 00000KT 140P99KT 12006G18KT 24016G28KT 02010KT 350V070 ///10KT 240//KT /////KT
6	Visibility	0350 7000 9999 0800 //// 2000 1200NW 6000 2800E 6000 2800 CAVOK ⁽¹⁾

¹ Replacing visibility, runway visual range, present weather, and cloud elements, when applicable.

7	Runway visual range	R32/0400 R12R/1700 R16L/0650 R16C/0500 R16R/0450 R17L/0450 R14L/P2000 R10/M0050 R16L///// R10///// R08L///// R08R/0400 R12/1100U R26/0550N R20/0800D R12/0700
8	Present weather	RA HZ VCFG +TSRA FG VCSH +DZ VA VCTS -SN MIFG VCBLA +TSRASN -SNRA DZ FG +SHSN BLSN UP FZUP //
9	Cloud	FEW015 SCT010 OVC020 BKN016TCU SCT008 BKN025CB BKN025/// /////CB NSC NCD VV005 VV/// BKN/// ///015 ////////// ///// BKN///TCU
10	Air temperature and dew-point temperature	17/10 02/M08 M01/M10 ///10 17/// /////

11	Pressure values	Q0995 Q1022 Q///
12	Supplementary information	REFZRA RETSRA WS R03 WS ALL RWY WS R18C W15/S2 W12/H75 W///S3 WM01/S/ W///H104 W17/H/// W///H/// W///S/
13	Trend forecast	NOSIG BECMG FEW020 TEMPO 25036G50KT BECMG FM1030 TL1130 CAVOK BECMG TL1700 0800 FG BECMG AT1800 9000 NSW BECMG FM1900 0500 +SNRA BECMG FM1100 SN TEMPO FM1130 BLSN TEMPO FM0330 TL0430 FZRA TEMPO TL1200 0600 BECMG AT1200 8000 NSW NSC BECMG AT1130 OVC010 TEMPO TL1530 +SHRA BKN012CB

Appendix 2

Regulation (EU) 2017/373

Fixed areas of coverage of WAFS forecasts in chart form

Mercator projection

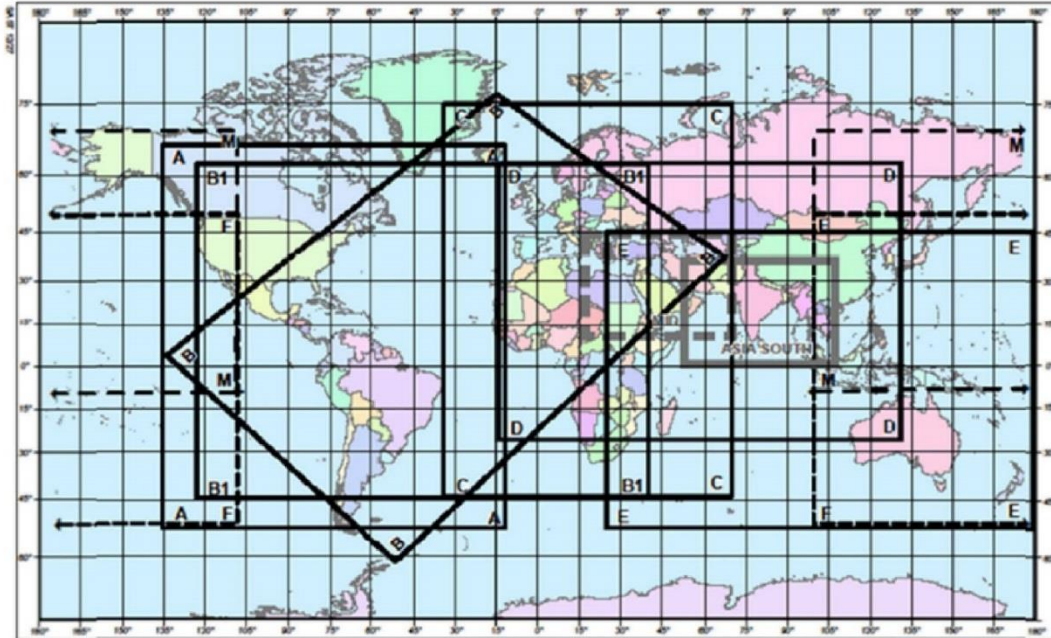

CHART	LATITUDE	LONGITUDE	CHART	LATITUDE	LONGITUDE
A	N6700	W13724	D	N6300	W01500
A	N6700	W01236	D	N6300	E13200
A	S5400	W01236	D	S2700	E13200
A	S5400	W13724	D	S2700	W01500
ASIA	N3600	E05300	E	N4455	E02446
ASIA	N3600	E10800	E	N4455	E18000
ASIA	0000	E10800	E	S5355	E18000
ASIA	0000	E05300	E	S5355	E02446
B	N0304	W13557	F	N5000	E10000
B	N7644	W01545	F	N5000	W11000
B	N3707	E06732	F	S5242	W11000
B	S6217	W05240	F	S5242	E10000
B1	N6242	W12500	M	N7000	E10000
B1	N6242	E04000	M	N7000	W11000
B1	S4530	E04000	M	S1000	W11000
B1	S4530	W12500	M	S1000	E10000
C	N7500	W03500	MID	N4400	E01700
C	N7500	E07000	MID	N4400	E07000
C	S4500	E07000	MID	N1000	E07000
C	S4500	W03500	MID	N1000	E01700

Polar stereographic projection (northern hemisphere)

CHART	LATITUDE	LONGITUDE	CHART	LATITUDE	LONGITUDE
EUR	N4633	W05634	I	N1912	E11130
EUR	N5842	E06824	I	N3330	W06012
EUR	N2621	E03325	I	N0126	W12327
EUR	N2123	W02136	I	S0647	E16601
G	N3552	W02822	L	N1205	E11449
G	N1341	E15711	L	N1518	E04500
G	S0916	E10651	L	N2020	W06900
G	S0048	E03447	L	N1413	W14338
H	N3127	W14836	NAT	N4439	W10143
H	N2411	E05645	NAT	N5042	E06017
H	N0127	W00651	NAT	N1938	E00957
H	N0133	W07902	NAT	N1711	W05406

Polar stereographic projection (southern hemisphere)

CHART	LATITUDE	LONGITUDE
J	S0318	W17812
J	N0037	W10032
J	S2000	W03400
J	S2806	E10717
K	N1255	E05549
K	N0642	E12905
K	S2744	W16841
K	S1105	E00317

Appendix 3

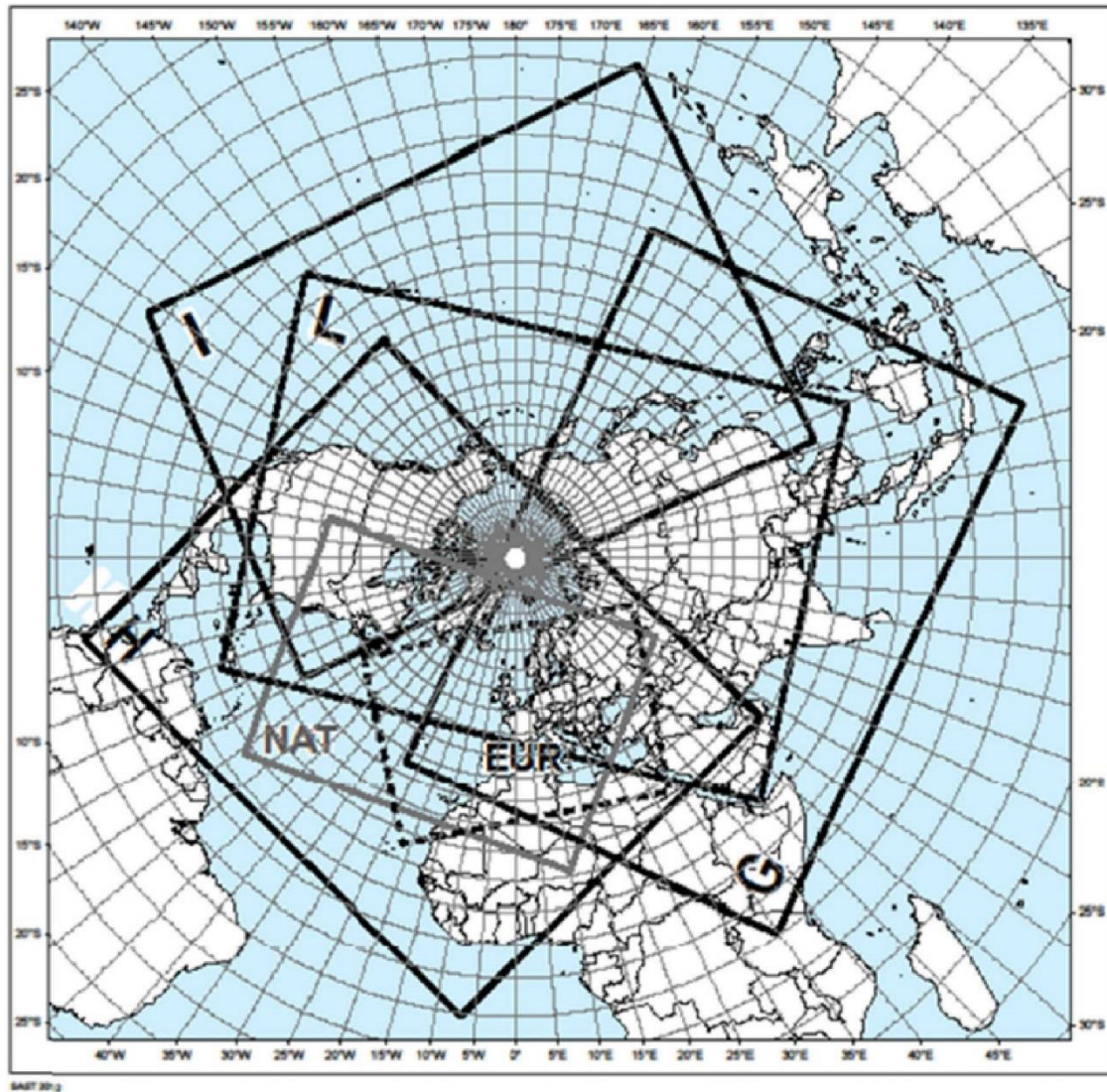
Regulation (EU) 2021/1338

Template for TAF

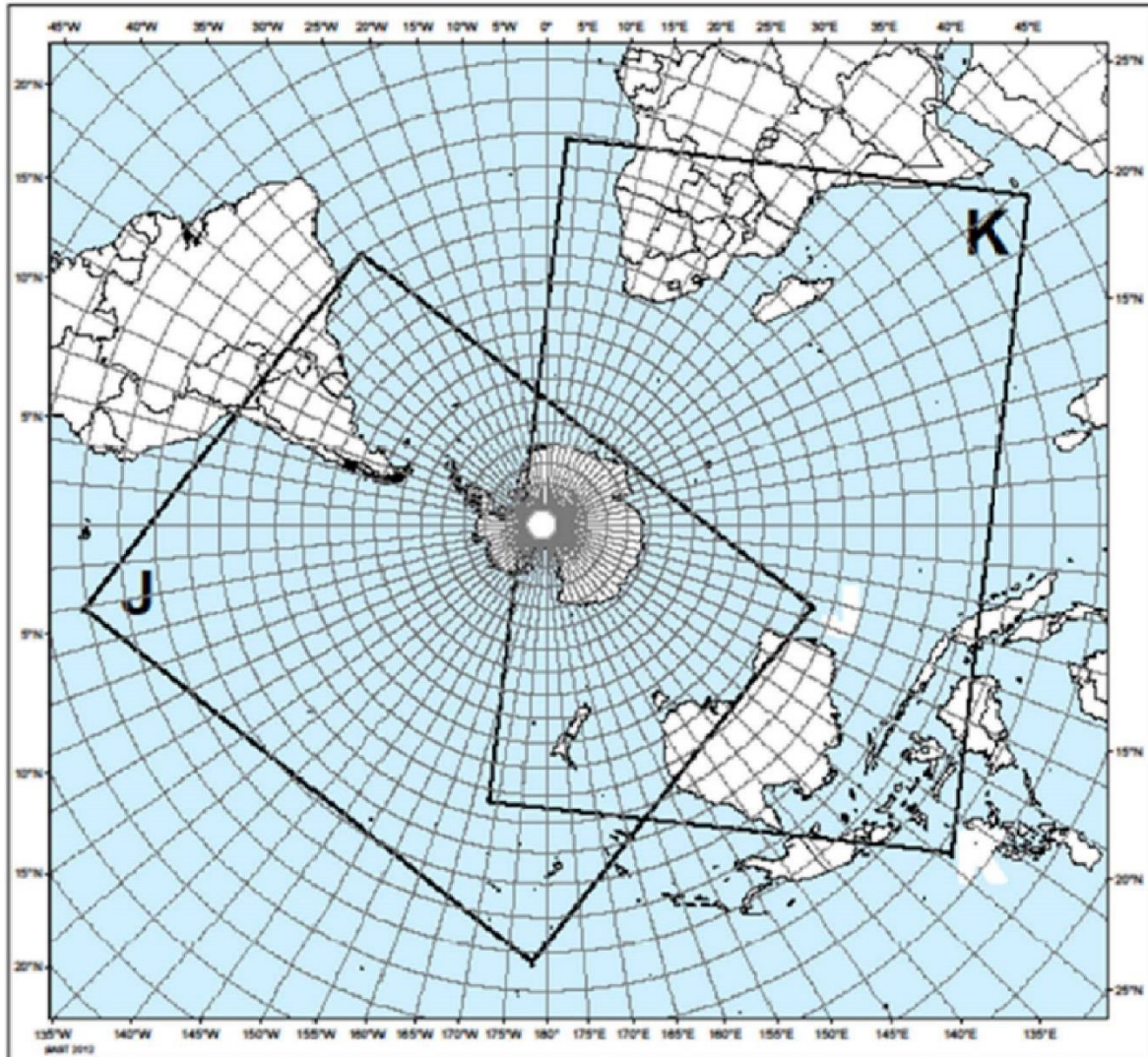
Key:

M = inclusion mandatory;

C = inclusion conditional, dependent on meteorological conditions or method of observation;

O = inclusion optional.

Note 1: The ranges and resolutions for the numerical elements included in TAF are provided in a separate table below this template.

Note 2: The explanations for the abbreviations can be found in ICAO Doc 8400 Procedures for Air Navigation Services — ICAO Abbreviations and Codes (PANS-ABC).

Note 3: Row numbers in the 'Ref.' column are included only for clarity and ease of reference, and are not part of the TAF.

Ref.	Element	Detailed content	Template(s)
1	Identification of the type of forecast (M)	Type of forecast (M)	TAF or TAF AMD or TAF COR
2	Location indicator (M)	ICAO location indicator (M)	nnnn
3	Time of issue of the forecast (M)	Day and time of issue of the forecast in UTC (M)	nnnnnnZ
4	Identification of a missing forecast (C)	Missing forecast identifier (C)	NIL
5	END OF TAF IF THE FORECAST IS MISSING.		
6	Days and period of validity of the forecast (M)	Days and period of validity of the forecast in UTC (M)	nnnn/nnnn
7	Identification of a cancelled forecast (C)	Cancelled forecast identifier (C)	CNL
8	END OF TAF IF THE FORECAST IS CANCELLED.		
9	Surface wind (M)	Wind direction (M)	nnn or VRB
		Wind speed (M)	[P]nn[n]
		Significant speed variations (C)	G[P]nn[n]
		Units of measurement (M)	KT
10	Visibility (M)	Prevailing visibility (M)	nnnn
11	Weather (C)	Intensity of weather phenomena (C) ¹	– or +
		Characteristics and type of weather phenomena (C)	DZ or RA or SN or SG or PL or DS or SS or FZDZ or FZRA or SHGR or SHGS or SHRA or SHSN or TSGR or FG or BR or SA or DU or HZ or FU or VA or

C
A
V
O
K

¹ To be included whenever applicable. No qualifier for moderate intensity.

			TSGS or TSRA or TSSN	SQ or PO or FC or TS or BCFG or BLDU or BLSA or BLSN or DRDU or DRSA or DRSN or FZFG or MIFG or PRFG		
12	Cloud (M) ⁽¹⁾	Cloud amount and height of base or vertical visibility (M)	FEWnnn or SCTnnn or BKNnnn or OVCnnn	VVnnn or VV///	N S C	
		Cloud type (C)	CB or TCU	—		
13	Temperature (O) ⁽²⁾	Name of the element (M)	TX			
		Maximum temperature (M)	[M]nn/			
		Day and time of occurrence of the maximum temperature (M)	nnnnZ			
		Name of the element (M)	TN			
		Minimum temperature (M)	[M]nn/			
		Day and time of occurrence of the minimum temperature (M)	nnnnZ			
14	Expected significant changes to one or more of the above elements during the period of validity (C)	Change or probability indicator (M)	PROB30 [TEMPO] or PROB40 [TEMPO] or BECMG or TEMPO or FM			
		Period of occurrence or change (M)	nnnn/nnnn or nnnnnn			
		Wind (C)	nnn[P]nn[G[P]nn]KT or VRBnnKT			
		Prevailing visibility (C)	nnnn			
		Weather phenomenon: intensity (C)	– or +	—	N S W	C A V O K
		Weather phenomenon: characteristics and type (C)	DZ or RA or SN or SG or PL or DS or SS or FZDZ or	FG or BR or SA or DU or HZ or FU or VA or SQ or		

¹ Up to four cloud layers.

² Consisting of up to a maximum of four temperatures (two maximum temperatures and two minimum temperatures).

			FZRA or SHGR or SHGS or SHRA or SHSN or TSGR or TSGS or TSRA or TSSN	PO or FC or TS or BCFG or BLDU or BLSA or BLSN or DRDU or DRSA or DRSN or FZFG or MIFG or PRFG		
15		Cloud amount and height of base or vertical visibility (C)	FEWnnn or SCTnnn or BKNnnn or OVCnnn	VVnnn or VV///	N S C	
		Cloud type (C)	CB or TCU	—		

Ranges and resolutions for the numerical elements included in TAF				
Ref.	Elements		Range	Resolution
1	Wind direction:	° true	000–360	10
2	Wind speed:	KT	00–99	1
3	Visibility:	M	0000–0750	50
		M	0800–4 900	100
		M	5 000–9 000	1 000
		M	10 000 or greater	0 (fixed value: 9 999)
4	Vertical visibility:	100's FT	000–020	1
5	Cloud: height of cloud base:		000–099	1
			100–200	10
6	Air temperature (maximum and minimum):	°C	–80 – +60	1'

GM1 to Appendix 3 ‘Template for TAF’

ED Decision 2022/004/R

TAF — EXAMPLES OF ELEMENTS

Non-exhaustive examples of the different elements used in the formulation of TAF are provided below.

TAF — examples of elements

Note 1: Consult the ‘Template for TAF’ ([Appendix 3 to Annex V \(Part-MET\)](#) to Regulation (EU) 2017/373) to identify the mandatory (M), the conditional (C) or the optional (O) elements.

Note 2: The ranges and resolutions for the numerical elements included in TAF are provided in [Appendix 3 to Annex V \(Part-MET\)](#) to Regulation (EU) 2017/373.

Note 3: The row numbers in the ‘Ref.’ column are included only for clarity and ease of reference, and are not part of the TAF. They do not correlate with the ‘Ref.’ column in the ‘Template for TAF’ of [Appendix 3 to Annex V \(Part-MET\)](#) to Regulation (EU) 2017/373. Refer to the ‘Element’ column when cross-referencing.

Ref.	Element	Examples
1	Identification of the type of forecast	TAF TAF AMD TAF COR
2	ICAO location indicator	YUDO
3	Time of issue of the forecast	160000Z
4	Identification of a missing forecast	NIL
5	Days and period of validity of the forecast	0812/0918
6	Identification of a cancelled forecast	CNL
7	Surface wind	24008KT VRB02KT 19010KT 00000KT 140P99KT 24016G28KT
8	Visibility	0350 7000 9999 CAVOK ⁽¹⁾
9	Forecast weather	RA HZ +TSRA FG -FZDZ PRFG +TSRASN SNRA BR

¹ Replacing visibility, runway visual range, forecast weather and cloud elements, when applicable.

10	Cloud	FEW010 OVC020 NSC SCT005 BKN012 SCT008 BKN025CB VV005 VV///
11	Temperature	TX25/1013Z TN09/1005Z TX05/2112Z TNM02/2103Z TX22/1115Z TN10/1204Z TX26/1215Z TX26/1215Z TN11/1306Z Tx25/1315Z
12	Expected significant changes to one or more of the above elements during the period of validity of the forecast	TEMPO 0815/0818 25034G50KT TEMPO 2212/2214 17012G26KT 1000 TSRA SCT010CB BKN020 BECMG 3010/3011 00000KT 2400 OVC010 PROB30 1412/1414 0800 FG BECMG 1412/1414 RA TEMPO 2503/2504 FZRA TEMPO 0612/0615 BLSN PROB40 TEMPO 2923/3001 0500 FG FM051230 15008KT 9999 BKN020 BECMG 1618/1620 8000 NSW NSC BECMG 2306/2308 SCT015CB BKN020

Appendix 4

Regulation (EU) 2021/1338

Template for wind shear warnings

Key:

M = inclusion mandatory;

C = inclusion conditional, whenever applicable.

Note 1: The ranges and resolutions for the numerical elements included in wind shear warnings are shown in Appendix 8.

Note 2: The explanations for the abbreviations can be found in ICAO Doc 8400 *Procedures for Air Navigation Services — ICAO Abbreviations and Codes (PANS-ABC)*.

Note 3: Row numbers in the 'Ref.' column are included only for clarity and ease of reference, and are not part of the wind shear warning.

Ref	Element	Detailed content	Template(s)
1	Location indicator of the aerodrome (M)	Location indicator of the aerodrome	nnnn
2	Identification of the type of message (M)	Type of message and sequence number	WS WRNG [n]n
3	Time of origin and validity period (M)	Day and time of issue and, where applicable, validity period in UTC	nnnnnn [VALID TL nnnnnn] <i>or</i> [VALID nnnnnn/nnnnnn]
4	IF THE WIND SHEAR WARNING IS TO BE CANCELLED, SEE DETAILS AT THE END OF THE TEMPLATE.		
5	Phenomenon (M)	Identification of the phenomenon and its location	[MOD] <i>or</i> [SEV] WS IN APCH <i>or</i> [MOD] <i>or</i> [SEV] WS [APCH] RWYnnn <i>or</i> [MOD] <i>or</i> [SEV] WS IN CLIMB-OUT <i>or</i> [MOD] <i>or</i> [SEV] WS CLIMB-OUT RWYnnn <i>or</i> MBST IN APCH <i>or</i> MBST [APCH] RWYnnn <i>or</i> MBST IN CLIMB-OUT <i>or</i> MBST CLIMB-OUT RWYnnn
6	Observed, reported or forecast phenomenon (M)	Identification whether the phenomenon is observed or reported and expected to continue, or forecast	REP AT nnnn nnnnnnnn <i>or</i> OBS [AT nnnn] <i>or</i> FCST
7	Details of the phenomenon (C)	Description of the phenomenon causing	SFC WIND: nnn/nnKT nnnFT – WIND: nnn/nnKT <i>or</i> nnKT LOSS nnNM (<i>or</i> nnKM) FNA RWYnn <i>or</i>

		the issuance of the wind shear warning	nnKT GAIN nnNM (or nnKM) FNA RWYnn
	OR		
8	Cancellation of wind shear warning	Cancellation of wind shear warning referring to its identification	CNL WS WRNG [n]n nnnnnn/nnnnnn

GM1 to Appendix 4 ‘Template for wind shear warnings’

ED Decision 2022/004/R

WIND SHEAR WARNINGS — EXAMPLES OF ELEMENTS

Non-exhaustive examples of the different elements used in the formulation of wind shear warnings are provided below.

Wind shear warnings — examples of elements

Note 1: Consult the ‘Template for wind shear warnings’ ([Appendix 4 to Annex V \(Part-MET\)](#) to Regulation (EU) 2017/373) to identify the mandatory (M), the conditional (C) or the optional (O) elements.

Note 2: The ranges and resolutions for the numerical elements included in wind shear warnings are provided in [Appendix 8 to Annex V \(Part-MET\)](#) to Regulation (EU) 2017/373.

Note 3: The row numbers in the ‘Ref.’ column are included only for clarity and ease of reference, and are not part of the wind shear warning. They do not correlate with the ‘Ref.’ column in the ‘Template for wind shear warnings’ of [Appendix 4 to Annex V \(Part-MET\)](#) to Regulation (EU) 2017/373. Refer to the ‘Element’ column when cross-referencing.

Ref.	Element	Example
1	Location indicator of the aerodrome	YUCC
2	Identification of the type of message	WS WRNG 1
3	Time of origin and validity period	211230 VALID TL 211330 221200 VALID 221215/221315
4	Phenomenon	WS APCH RWY12 MOD WS RWY34 WS IN CLIMB-OUT MBST APCH RWY26 MBST IN CLIMB-OUT
5	Observed, reported or forecast phenomenon	REP AT 1510 B747 OBS AT 1205 FCST
6	Details of the phenomenon	SFC WIND: 320/10KT 200FT-WIND: 360/26KT 30KT LOSS 2NM FNA RWY13
OR		
7	Cancellation of the wind shear warning	CNL WS WRNG 1 211230/211330

Appendix 5

Regulation (EU) 2021/1338

Template for SIGMET and AIRMET

Key:

M = inclusion mandatory;

C = inclusion conditional, whenever applicable; and

Note 1: The ranges and resolutions for the numerical elements included in SIGMET or AIRMET are shown in Appendix 8.

Note 2: Severe or moderate icing (SEV ICE, MOD ICE) and severe or moderate turbulence (SEV TURB, MOD TURB) associated with thunderstorms, cumulonimbus clouds or tropical cyclones should not be included.

Note 3: Row numbers in the 'Ref.' column are included only for clarity and ease of reference, and are not part of the SIGMET or AIRMET.

Ref.	Element	Detailed content	SIGMET template	AIRMET template
1	Location indicator of FIR/CTA (M)	ICAO location indicator of the ATS unit serving the FIR or CTA to which the SIGMET/AIRMET refers	nnnn	
2	Identification (M)	SIGMET or AIRMET identification and sequence number	SIGMET nnn	AIRMET [n][n]n
3	Validity period (M)	Day-time groups indicating the period of validity in UTC	VALID nnnnnn/nnnnnn	
4	Location indicator of MWO (M)	Location indicator of MWO originating the SIGMET or AIRMET with a separating hyphen	nnnn-	
5	New line			
6	Name of the FIR/CTA (M)	Location indicator and name of the FIR/CTA for which the SIGMET/AIRMET is issued	nnnn nnnnnnnnnn FIR or UIR or FIR/UIR or nnnn nnnnnnnnnn CTA	nnnn nnnnnnnnnn FIR[/n]
7	IF THE SIGMET OR AIRMET IS TO BE CANCELLED, SEE DETAILS AT THE END OF THE TEMPLATE.			
8	Status indicator (C) ⁽¹⁾	Indicator of test or exercise	TEST or EXER	TEST or EXER
9	New line			

¹ Used only when SIGMET/AIRMET is issued to indicate that a test or an exercise is taking place. When the word 'TEST' or the abbreviation 'EXER' is included, the message may contain information that should not be used operationally or will otherwise end immediately after the word 'TEST'.

10	Phenomenon (M)	Description of the phenomenon causing the issuance of SIGMET/AIRMET	OBSC TS[GR] EMBD TS[GR] FRQ TS[GR] SQL TS[GR] TC nnnnnnnnnn PSN Nnn[nn] or Snn[nn] Wnnn[nn] or Ennn[nn] CB or TC NN ⁽¹⁾ PSN Nnn[nn] or Snn[nn] Wnnn[nn] or Ennn[nn] CB SEV TURB SEV ICE SEV ICE (FZRA) SEV MTW HVY DS HVY SS [VA ERUPTION] [MT nnnnnnnnnn] [PSN Nnn[nn] or Snn[nn] Ennn[nn] or Wnnn[nn]] VA CLD RDOACT CLD	SFC WIND nnn/nn[n]KT SFC VIS [n][n]nnM (nn) ISOL TS[GR] OCNL TS[GR] MT OBSC BKN CLD BKN CLD [n]nnn/[ABV][n]nnnnFT or BKN CLD SFC/[ABV][n]nnnnFT or OVC CLD [n]nnn/[ABV][n]nnnnFT or OVC CLD SFC/[ABV][n]nnnnFT ISOL CB OCNL CB FRQ CB ISOL TCU OCNL TCU FRQ TCU MOD TURB MOD ICE MOD MTW
11	Observed or forecast phenomenon (M) ^{(2),(3)}	Indication whether the information is observed and expected to continue, or forecast	OBS [AT nnnnZ] or FCST [AT nnnnZ]	
12	Location (C) ^{(4),(5),(6)}	Location (referring to latitude and longitude (in degrees and minutes))	Nnn[nn] Wnnn[nn] or Nnn[nn] Ennn[nn] or Snn[nn] Wnnn[nn] or Snn[nn] Ennn[nn] or N OF Nnn[nn] or S OF Nnn[nn] or N OF Snn[nn] or	

¹ Used for unnamed tropical cyclones.

² In the case of volcanic ash cloud covering more than one area within the FIR, these elements can be repeated, as necessary. Each location and forecast position are to be preceded by an observed or forecast time.

³ In the case of cumulonimbus clouds associated with a tropical cyclone covering more than one area within the FIR, these elements can be repeated as necessary. Each location and forecast position must be preceded by an observed or forecast time.

⁴ In the case of volcanic ash cloud covering more than one area within the FIR, these elements can be repeated, as necessary. Each location and forecast position are to be preceded by an observed or forecast time.

⁵ In the case of cumulonimbus clouds associated with a tropical cyclone covering more than one area within the FIR, these elements can be repeated as necessary. Each location and forecast position must be preceded by an observed or forecast time.

⁶ For SIGMET for radioactive cloud, only within (WI) is to be used for the elements 'location' and 'forecast position'.

			<p>S OF Snn[nn] or [AND] W OF Wnnn[nn] or E OF Wnnn[nn] or W OF Ennn[nn] or E OF Ennn[nn] or N OF Nnn[nn] or N OF Snn[nn] AND S OF Nnn[nn] or S OF Snn[nn] or W OF Wnnn[nn] or W OF Ennn[nn] AND E OF Wnnn[nn] or E OF Ennn[nn] or N OF LINE or NE OF LINE or E OF LINE or SE OF LINE or S OF LINE or SW OF LINE or W OF LINE or NW OF LINE Nnn[nn] or Snn[nn] Wnnn[nn] or Ennn[nn] – Nnn[nn] or Snn[nn] Wnnn[nn] or Ennn[nn] [– Nnn[nn] or Snn[nn] Wnnn[nn] or Ennn[nn]] [– Nnn[nn] or Snn[nn] Wnnn[nn] or Ennn[nn]] [AND N OF LINE or NE OF LINE or E OF LINE or SE OF LINE or S OF LINE or SW OF LINE or W OF LINE or NW OF LINE Nnn[nn] or Snn[nn] Wnnn[nn] or Ennn[nn] – Nnn[nn] or Snn[nn] Wnnn[nn] or Ennn[nn] [– Nnn[nn] or Snn[nn] Wnnn[nn] or Ennn[nn]] [– Nnn[nn] or Snn[nn] Wnnn[nn] or Ennn[nn]]] or WI Nnn[nn] or Snn[nn] Wnnn[nn] or Ennn[nn] – Nnn[nn] or Snn[nn] Wnnn[nn] or Ennn[nn] – Nnn[nn] or Snn[nn] Wnnn[nn] or Ennn[nn] – [Nnn[nn] or Snn[nn] Wnnn[nn] or Ennn[nn] – Nnn[nn] or Snn[nn] Wnnn[nn] or Ennn[nn]]⁽¹⁾ or ENTIRE UIR or ENTIRE FIR or ENTIRE FIR/UIR or ENTIRE CTA or WI nnnKM (or nnnNM) OF TC CENTRE ⁽²⁾ or WI nnKM (or nnNM) OF Nnn[nn] or Snn[nn] Wnnn[nn] or Ennn[nn] ⁽³⁾</p>
13	Level (C)	Flight level or altitude	<p>[SFC/]FLnnn or [SFC/][n]nnnnFT (or [SFC/]nnnnM) FLnnn/nnn or TOP FLnnn or [TOP] ABV FLnnn or (or [TOP] ABV [n]nnnnFT) [[n]nnnn/][n]nnnnFT) or [n]nnnnFT/]FLnnn or TOP [ABV or BLW] FLnnn ⁽⁴⁾</p>
14	Movement or expected movement (C) ^{(5),(6),(7)}	Movement or expected movement (direction and speed) with	<p>MOV N [nnKMH] or MOV NNE [nnKMH] or MOV NE [nnKMH] or MOV ENE [nnKMH] or MOV E [nnKMH] or MOV ESE [nnKMH] or MOV SE [nnKMH] or MOV SSE [nnKMH] or</p>

¹ The number of coordinates are to be kept to a minimum and should not normally exceed seven.

² Only for SIGMET for tropical cyclones.

³ Only for SIGMET for radioactive cloud. A radius of up to 30 kilometres (or 16 nautical miles) from the source and a vertical extent from surface (SFC) to the upper limit of the flight information region/upper flight information region (FIR/UIR) or control area (CTA) is to be applied.

⁴ Only for SIGMET for tropical cyclones.

⁵ In the case of volcanic ash cloud covering more than one area within the FIR, these elements can be repeated, as necessary. Each location and forecast position are to be preceded by an observed or forecast time.

⁶ The elements ‘forecast time’ and ‘forecast position’ are not to be used in conjunction with the element ‘movement or expected movement’.

⁷ For SIGMET for radioactive cloud, only stationary (STNR) is to be used for the element ‘movement or expected movement’.

		reference to one of the 16 points of compass, or stationary	MOV S [nnKMH] or MOV SSW [nnKMH] or MOV SW [nnKMH] or MOV WSW [nnKMH] or MOV W [nnKMH] or MOV WNW [nnKMH] or MOV NW [nnKMH] or MOV NNW [nnKMH] (or MOV N [nnKT] or MOV NNE [nnKT] or MOV NE [nnKT] or MOV ENE [nnKT] or MOV E [nnKT] or MOV ESE [nnKT] or MOV SE [nnKT] or MOV SSE [nnKT] or MOV S [nnKT] or MOV SSW [nnKT] or MOV SW [nnKT] or MOV WSW [nnKT] or MOV W [nnKT] or MOV WNW [nnKT] or MOV NW [nnKT] or MOV NNW [nnKT]) or STNR	
15	Changes in intensity (C) ⁽¹⁾	Expected changes in intensity	INTSF or WKN or NC	
16	Forecast time (C) ^{(2),(3),(4)}	Indication of the forecast time of the phenomenon	FCST AT nnnnZ	—
17	TC forecast position (C) ⁽⁵⁾	Forecast position of the TC centre	TC CENTRE PSN Nnn[nn] or Snn[nn] Wnnn[nn] or Ennn[nn] or TC CENTRE PSN Nnn[nn] or Snn[nn] Wnnn[nn] or Ennn[nn] CB ⁽⁶⁾	—
18	Forecast position (C) ^{(7),(8),(9),(10)}	Forecast position of the phenomenon at the end of the validity period of the SIGMET ⁽¹¹⁾	Nnn[nn] Wnnn[nn] or Nnn[nn] Ennn[nn] or Snn[nn] Wnnn[nn] or Snn[nn] Ennn[nn] or N OF Nnn[nn] or	—

¹ In the case of volcanic ash cloud covering more than one area within the FIR, these elements can be repeated, as necessary. Each location and forecast position are to be preceded by an observed or forecast time.

² In the case of volcanic ash cloud covering more than one area within the FIR, these elements can be repeated, as necessary. Each location and forecast position are to be preceded by an observed or forecast time.

³ In the case of cumulonimbus clouds associated with a tropical cyclone covering more than one area within the FIR, these elements can be repeated as necessary. Each location and forecast position must be preceded by an observed or forecast time.

⁴ The elements 'forecast time' and 'forecast position' are not to be used in conjunction with the element 'movement or expected movement'.

⁵ Only for SIGMET for tropical cyclones.

⁶ The term 'CB' is to be used when the forecast position for the cumulonimbus cloud is included.

⁷ In the case of volcanic ash cloud covering more than one area within the FIR, these elements can be repeated, as necessary. Each location and forecast position are to be preceded by an observed or forecast time.

⁸ In the case of cumulonimbus clouds associated with a tropical cyclone covering more than one area within the FIR, these elements can be repeated as necessary. Each location and forecast position must be preceded by an observed or forecast time.

⁹ For SIGMET for radioactive cloud, only within (WI) is to be used for the elements 'location' and 'forecast position'.

¹⁰ The elements 'forecast time' and 'forecast position' are not to be used in conjunction with the element 'movement or expected movement'.

¹¹ The forecast position for cumulonimbus (CB) cloud occurring in connection with tropical cyclones relates to the forecast time of the tropical cyclone centre position, not to the end of the validity period of the SIGMET.

			<p>S OF Nnn[nn] or N OF Snn[nn] or S OF Snn[nn] [AND] W OF Wnnn[nn] or E OF Wnnn[nn] or W OF Ennn[nn] or E OF Ennn[nn] or N OF Nnn[nn] or N OF Snn[nn] AND S OF Nnn[nn] or S OF Snn[nn] or W OF Wnnn[nn] or W OF Ennn[nn] AND E OF Wnnn[nn] or E OF Ennn[nn] or N OF LINE or NE OF LINE or E OF LINE or SE OF LINE or S OF LINE or SW OF LINE or W OF LINE or NW OF LINE Nnn[nn] or Snn[nn] Wnnn[nn] or Ennn[nn] – Nnn[nn] or Snn[nn] Wnnn[nn] or Ennn[nn] [– Nnn[nn] or Snn[nn] Wnnn[nn] or Ennn[nn]] [AND N OF LINE or NE OF LINE or E OF LINE or SE OF LINE or S OF LINE or SW OF LINE or W OF LINE or NW OF LINE Nnn[nn] or Snn[nn] Wnnn[nn] or Ennn[nn] – Nnn[nn] or Snn[nn] Wnnn[nn] or Ennn[nn] [– Nnn[nn] or Snn[nn] Wnnn[nn] or Ennn[nn]]] or WI Nnn[nn] or Snn[nn] Wnnn[nn] or Ennn[nn] – Nnn[nn] or Snn[nn] Wnnn[nn] or Ennn[nn] – Nnn[nn] or Snn[nn] Wnnn[nn] or Ennn[nn] – Nnn[nn] or Snn[nn] Wnnn[nn] or Ennn[nn] ⁽¹⁾ or ENTIRE FIR or ENTIRE UIR or ENTIRE FIR/UIR or ENTIRE CTA or NO VA EXP ⁽²⁾ or WI nnKM (or nnNM) OF Nnn[nn] or Snn[nn] Wnnn[nn] or Ennn[nn] ⁽³⁾</p>	
--	--	--	--	--

¹ The number of coordinates are to be kept to a minimum and should not normally exceed seven.

² Only for SIGMET for volcanic ash.

³ Only for SIGMET for radioactive cloud. A radius of up to 30 kilometres (or 16 nautical miles) from the source and a vertical extent from surface (SFC) to the upper limit of the flight information region/upper flight information region (FIR/UIR) or control area (CTA) is to be applied.

			or WI nnnKM (nnnNM) OF TC CENTRE ⁽¹⁾	
19	Repetition of elements (C) ⁽²⁾	Repetition of elements included in a SIGMET for volcanic ash cloud or tropical cyclone	[AND] ⁽³⁾	—
20	New line if repeating elements			
OR				
21	Cancellation of SIGMET/AIRMET (C)	Cancellation of SIGMET/AIRMET referring to its identification	CNL SIGMET nnn nnnnnn/nnnnnn or CNL SIGMET nnn nnnnnn/nnnnnn [VA MOV TO nnnn FIR] ⁽⁴⁾	CNL AIRMET [n][n]n nnnnnn/nnnnnn

GM1 to Appendix 5 ‘Template for SIGMET and AIRMET’

ED Decision 2022/004/R

SIGMET AND AIRMET — EXAMPLES OF ELEMENTS

Non-exhaustive examples of the different elements used in the formulation of SIGMET and AIRMET are provided below.

SIGMET and AIRMET — examples of elements

Note 1: Consult the ‘Template for SIGMET and AIRMET’ ([Appendix 5 to Annex V \(Part-MET\)](#) to Regulation (EU) 2017/373) to identify the mandatory (M), the conditional (C) or the optional (O) elements.

Note 2: The ranges and resolutions for the numerical elements included in SIGMET and AIRMET are provided in [Appendix 8 to Annex V \(Part-MET\)](#) to Regulation (EU) 2017/373.

Note 3: The row numbers in the ‘Ref.’ column are included only for clarity and ease of reference, and are not part of the SIGMET and AIRMET. They do not correlate with the ‘Ref.’ column in the ‘Template for SIGMET and AIRMET’ of [Appendix 5 to Annex V \(Part-MET\)](#) to Regulation (EU) 2017/373. Refer to the ‘Element’ column when cross-referencing.

Ref.	Element	SIGMET examples	AIRMET examples
1	ICAO location indicator of FIR/CTA	YUCC YUDD	
2	Identification	SIGMET U05 SIGMET I12	AIRMET 2 AIRMET 19 AIRMET B19

¹ Only for SIGMET for tropical cyclones.

² To be used for more than one volcanic ash clouds or cumulonimbus clouds associated with a tropical cyclone simultaneously affecting the FIR concerned.’

³ To be used for more than one volcanic ash clouds or cumulonimbus clouds associated with a tropical cyclone simultaneously affecting the FIR concerned.’

⁴ Only for SIGMET for volcanic ash.

3	Validity period	VALID 010000/010400 VALID 221215/221600 VALID 101520/101800 VALID 251600/252200 VALID 152000/160000 VALID 192300/200300	
4	ICAO location indicator of MWO	YUDO– YUSO–	
5	Name of the FIR/CTA	YUCC AMSWELL FIR YUDD SHANLON FIR/UIR UIR FIR/UIR YUDD SHANLON CTA	YUCC AMSWELL FIR/2 YUDD SHANLON FIR
6	IF THE SIGMET IS TO BE CANCELLED, SEE DETAILS AT THE END OF THE TABLE.		
7	Status indicator	TEST EXER	TEST EXER
8	Phenomenon	OBSC TS OBSC TSGR EMBD TS EMBD TSGR FRQ TS FRQ TSGR SQL TS SQL TSGR TC GLORIA PSN N10 W060 CB TC NN PSN S2030 E06030 CB SEV TURB SEV ICE SEV ICE (FZRA) SEV MTW HVY DS HVY SS VA ERUPTION MT ASHVAL PSN S15 E073 VA CLD RDOACT CLD	SFC WIND 310/40KT SFC VIS 1500M (BR) ISOL TS ISOL TSGR OCNL TS OCNL TSGR MT OBSC BKN CLD 400/3000FT BKN CLD 1000/5000FT BKN CLD SFC/ABV10000FT OVC CLD 900/ABV10000FT OVC CLD 1000/5000FT OVC CLD SFC/ABV10000FT ISOL CB OCNL CB FRQ CB ISOL TCU OCNL TCU FRQ TCU MOD TURB MOD ICE MOD MTW
9	Observed or forecast phenomenon	OBS OBS AT 1210Z FCST FCST AT 1815Z	

10	Location	<p>N2020 W07005 N48 E010 S60 W160 S0530 E16530</p> <p>N OF N50 S OF N5430 N OF S10 S OF S4530 W OF W155 E OF W45 W OF E15540 E OF E09015</p> <p>N OF N1515 AND W OF E13530 S OF N45 AND N OF N40</p> <p>N OF LINE S2520 W11510 – S2520 W12010 SW OF LINE N50 W005 – N60 W020 SW OF LINE N50 W020 – N45 E010 AND NE OF LINE N45 W020 – N40 E010</p> <p>WI N6030 E02550 – N6055 E02500 – N6050 E02630 – N6030 E02550</p> <p>ENTIRE FIR ENTIRE UIR ENTIRE FIR/UIR</p> <p>ENTIRE CTA</p> <p>WI 400KM OF TC CENTRE WI 250NM OF TC CENTRE</p> <p>WI 30KM OF N6030 E02550</p>
11	Level	<p>SFC/FL070 FL180 FL050/080 TOP FL390 ABV FL250 TOP ABV FL100 TOP FL500 TOP ABV FL500 TOP BLW FL450 SFC/10000FT 8000FT 6000/12000FT ABV 7000FT TOP ABV 9000FT TOP ABV 10000FT 10000FT/FL250 3000M SFC/3000M 2000/3000M 2000M/FL150</p>

12	Movement or expected movement	MOV SE MOV NNW MOV E 20KT MOV WSW 20KT (MOV E 40KMH) STNR	
13	Changes in intensity	INTSF WKN NC	
14	Forecast time	FCST AT 2200Z	—
15	TC forecast position	TC CENTRE PSN N1030 E16015 TC CENTRE PSN N1015 E15030 CB	—
16	Forecast position	N30 W170 N OF N30 S OF S50 AND W OF E170 S OF N46 AND N OF N39 NE OF LINE N35 W020 – N45 W040 SW OF LINE N48 W020 – N43 E010 AND NE OF LINE N43 W020 – N38 E010 WI N20 W090 – N05 W090 – N10 W100 – N20 W100 – N20 W090 ENTIRE FIR ENTIRE UIR ENTIRE FIR/UIR ENTIRE CTA NO VA EXP WI 30KM OF N6030 E02550 WI 150NM OF TC CENTRE	—
17	Repetition of elements	AND	—
OR			
18	Cancellation of SIGMET/ AIRMET	CNL SIGMET B04 101200/101600 CNL SIGMET A07 251030/251430 VA MOV TO YUDO FIR	CNL AIRMET 5 151520/151800

Appendix 6

Regulation (EU) 2021/1338

Template for advisory for volcanic ash

Key:

M = inclusion mandatory;

O = inclusion optional;

C = inclusion conditional, included whenever applicable.

Note 1: The ranges and resolutions for the numerical elements included in volcanic ash advisory are shown in Appendix 8.

Note 2: The explanations for the abbreviations can be found in ICAO Doc 8400 Procedures for Air Navigation Services — ICAO Abbreviations and Codes (PANS-ABC).

Note 3: The inclusion of a colon (':') after each element heading is mandatory.

Note 4: Row numbers in the 'Ref.' column are included only for clarity and ease of reference, and are not part of the advisory for volcanic ash.

Ref.	Element	Detailed content	Template(s)
1	Identification of the type of message (M)	Type of message	VA ADVISORY
2	New line		
3	Status indicator (C) ⁽¹⁾	Indicator of test or exercise	STATUS: TEST or EXER
4	New line		
5	Time of origin (M)	Year, month, day, time in UTC	DTG: nnnnnnnn/nnnnZ
6	New line		
7	Name of VAAC (M)	Name of VAAC	VAAC: nnnnnnnnnnnn
8	New line		
9	Name of volcano (M)	Name and International Association of Volcanology and Chemistry of the Earth's Interior number of volcano	VOLCANO: nnnnnnnnnnnnnnnnnnnnn [nnnnnn] or UNKNOWN or UNNAMED
10	New line		
11	Location of volcano (M)	Location of volcano in degrees and minutes	PSN: Nnnnn or Snnnn Wnnnnn or Ennnnn or UNKNOWN
12	New line		
13	State or region (M)	State, or region if ash is not reported over a State	AREA: nnnnnnnnnnnnnnnn or UNKNOWN

¹ Used only when the message is issued to indicate that a test or an exercise is taking place. When the word 'TEST' or the abbreviation 'EXER' is included, the message may contain information that should not be used operationally or will otherwise end immediately after the word 'TEST'.

14	New line			
15	Summit elevation (M)	Summit elevation in m (or ft)	SUMMIT ELEV:	nnnnM (or nnnnnFT) or SFC or UNKNOWN
16	New line			
17	Advisory number (M)	Advisory number: year in full and message number (separate sequence for each volcano)	ADVISORY NR:	nnnn/nnnn
18	New line			
19	Information source (M)	Information source using free text	INFO SOURCE:	Free text up to 32 characters
20	New line			
21	Colour code (O)	Aviation colour code	AVIATION COLOUR CODE:	RED or ORANGE or YELLOW or GREEN or UNKNOWN or NOT GIVEN or NIL
22	New line			
23	Eruption details (M) ⁽¹⁾	Eruption details (including date/time of eruption(s))	ERUPTION DETAILS:	Free text up to 64 characters or UNKNOWN
24	New line			
25	Time of observation (or estimation) of volcanic ash clouds (M)	Day and time (in UTC) of observation (or estimation) of volcanic ash clouds	OBS (or EST) VA DTG:	nn/nnnnZ
26	New line			

¹ The term 'resuspended' to be used for volcanic ash deposits raised by the wind.

27	Observed or estimated volcanic ash clouds (M)	Horizontal (in degrees and minutes) and vertical extent at the time of observation of the observed or estimated volcanic ash clouds or, if the base is unknown, the top of the observed or estimated volcanic ash clouds; Movement of the observed or estimated volcanic ash clouds	OBS VA CLD or EST VA CLD: TOP FLnnn or SFC/FLnnn or FLnnn/nnn [nnKM WID LINE BTN (nnNM WID LINE BTN)] Nnn[nn] or Snn[nn] Wnnn[nn] or Ennn[nn] – Nnn[nn] or Snn[nn] Wnnn[nn] or Ennn[nn][– Nnn[nn] or Snn[nn] Wnnn[nn] or Ennn[nn] – Nnn[nn] or Snn[nn] Wnnn[nn] or Ennn[nn] – Nnn[nn] or Snn[nn] Wnnn[nn] or Ennn[nn]] MOV N nnKMH (or KT) or MOV NE nnKMH (or KT) or MOV E nnKMH (or KT) or MOV SE nnKMH (or KT) or MOV S nnKMH (or KT) or MOV SW nnKMH (or KT) or MOV W nnKMH (or KT) or MOV NW nnKMH (or KT) or VA NOT IDENTIFIABLE FM SATELLITE DATA WIND FLnnn/nnn nnn/nn[n]KT ⁽¹⁾ or WIND FLnnn/nnn VRBnnKT or WIND SFC/FLnnn nnn/nn[n]KT or WIND SFC/FLnnn VRBnnKT
28	New line		
29	Forecast height and position of the volcanic ash clouds (+6 HR) (M)	Day and time (in UTC) (6 hours from the ‘Time of observation (or estimation) of volcanic ash clouds’ given in Item 12) Forecast height and position (in degrees and minutes) for each volcanic ash cloud mass for that fixed valid time	FCST VA CLD +6 HR: nn/nnnnZ SFC or FLnnn/[FL]nnn [nnKM WID LINE BTN (nnNM WID LINE BTN)]Nnn[nn] or Snn[nn] Wnnn[nn] or Ennn[nn] – Nnn[nn] or Snn[nn] Wnnn[nn] or Ennn[nn][– Nnn[nn] or Snn[nn] Wnnn[nn] or Ennn[nn] – Nnn[nn] or Snn[nn] Wnnn[nn] or Ennn[nn] – Nnn[nn] or Snn[nn] Wnnn[nn] or Ennn[nn]] ^{(2),(3)} or NO VA EXP or NOT AVBL or NOT PROVIDED
30	New line		

¹ If a volcanic ash cloud is reported (e.g. AIREP) but not identifiable from the satellite data.

² A straight line between two points drawn on a map in the Mercator projection or a straight line between two points which crosses lines of longitude at a constant angle.

³ Up to four selected layers.

31	Forecast height and position of the volcanic ash clouds (+12 HR) (M)	Day and time (in UTC) (12 hours from the 'Time of observation (or estimation) of volcanic ash clouds' given in Item 12) Forecast height and position (in degrees and minutes) for each volcanic ash cloud mass for that fixed valid time	FCST VA CLD +12 HR:	nn/nnnnZ SFC or FLnnn/[FL]nnn [nnKM WID LINE BTN (nnNM WID LINE BTN)] Nnn[nn] or Snn[nn] Wnnn[nn] or Ennn[nn] – Nnn[nn] or Snn[nn] Wnnn[nn] or Ennn[nn][– Nnn[nn] or Snn[nn] Wnnn[nn] or Ennn[nn] – Nnn[nn] or Snn[nn] Wnnn[nn] or Ennn[nn]] ^{(1),(2)} or NO VA EXP or NOT AVBL or NOT PROVIDED
32	New line			
33	Forecast height and position of the volcanic ash clouds (+18 HR)	Day and time (in UTC) (18 hours from the 'Time of observation (or estimation) of volcanic ash clouds' given in Item 12) Forecast height and position (in degrees and minutes) for each volcanic ash cloud mass for that fixed valid time	FCST VA CLD +18 HR:	nn/nnnnZ SFC or FLnnn/[FL]nnn [nnKM WID LINE BTN (nnNM WID LINE BTN)] Nnn[nn] or Snn[nn] Wnnn[nn] or Ennn[nn] – Nnn[nn] or Snn[nn] Wnnn[nn] or Ennn[nn][– Nnn[nn] or Snn[nn] Wnnn[nn] or Ennn[nn] – Nnn[nn] or Snn[nn] Wnnn[nn] or Ennn[nn] – Nnn[nn] or Snn[nn] Wnnn[nn] or Ennn[nn]] ^{(3),(4)} or NO VA EXP or NOT AVBL or NOT PROVIDED
34	New line			
35	Remarks (M) ⁽⁵⁾	Remarks, as necessary	RMK:	Free text up to 256 characters or NIL
36	New line			
37	Next advisory (M)	Year, month, day and time in UTC	NXT ADVISORY:	nnnnnnnn/nnnnZ or NO LATER THAN nnnnnnnn/nnnnZ or NO FURTHER ADVISORIES or WILL BE ISSUED BY nnnnnnnn/nnnnZ

GM1 to Appendix 6 'Template for advisory for volcanic ash'

ED Decision 2022/004/R

ADVISORY FOR VOLCANIC ASH — EXAMPLES OF ELEMENTS

¹ A straight line between two points drawn on a map in the Mercator projection or a straight line between two points which crosses lines of longitude at a constant angle.

² Up to four selected layers.

³ A straight line between two points drawn on a map in the Mercator projection or a straight line between two points which crosses lines of longitude at a constant angle.

⁴ Up to four selected layers.

⁵ The term 'resuspended' to be used for volcanic ash deposits raised by the wind.

Non-exhaustive examples of the different elements used in the formulation of advisory for volcanic ash are provided below.

Examples of elements

Note 1: Consult the ‘Template for advisory for volcanic ash’ ([Appendix 6 to Annex V \(Part-MET\)](#) to Regulation (EU) 2017/373) to identify the mandatory (M), the conditional (C) or the optional (O) elements.

Note 2: The ranges and resolutions for the numerical elements included in advisory for volcanic ash are provided in [Appendix 8 to Annex V \(Part-MET\)](#) to Regulation (EU) 2017/373.

Note 3: The row numbers in the ‘Ref.’ column are included only for clarity and ease of reference, and are not part of the advisory for volcanic ash. They do not correlate with the ‘Ref.’ column in the ‘Template for advisory for volcanic ash’ of [Appendix 6 to Annex V \(Part-MET\)](#) to Regulation (EU) 2017/373. Refer to the ‘Element’ column when cross-referencing.

Ref.	Element	Examples
1	Identification of the type of message	VA ADVISORY
2	Status indicator	STATUS: TEST EXER
3	Time of origin	DTG: 20080923/0130Z
4	Name of VAAC	VAAC: TOKYO
5	Name of volcano	VOLCANO: KARYMSKY 300130 UNNAMED UNKNOWN
6	Location of volcano	PSN: N5403 E15927 UNKNOWN
7	State or region	AREA: RUSSIA UNKNOWN
8	Summit elevation	SUMMIT ELEV: 1536M SFC
9	Advisory number	ADVISORY NR: 2008/4
10	Information source	INFO SOURCE: HIMAWARI-8 KVERT KEMSD
11	Colour code	AVIATION COLOUR CODE: RED
12	Eruption details	ERUPTION DETAILS: ERUPTION AT 20080923/0000Z FL300 REPORTED NO ERUPTION – RE-SUSPENDED VA ⁽¹⁾ UNKNOWN
13	Time of observation (or estimation) of volcanic ash clouds	OBS VA DTG: 23/0100Z

¹ To be included (as free text)

14	Observed or estimated volcanic ash clouds	OBS VA CLD:	FL250/300 N5400 E15930 – N5400 E16100 – N5300 E15945 – N5400 E15930 MOV SE 20KT SFC/FL200 N5130 E16130 – N5130 E16230 – N5230 E16230 – N5230 E16130 MOV SE 15KT TOP FL240 MOV W 40KMH VA NOT IDENTIFIABLE FM SATELLITE DATA WIND FL050/070 180/24KT
15	Forecast height and position of the volcanic ash clouds (+6 HR)	FCST VA CLD +6 HR:	23/0700Z FL250/350 N5130 E16030 – N5130 E16230 – N5330 E16230 – N5330 E16030 SFC/FL180 N4830 E16330 – N4830 E16630 – N5130 E16630 – N5130 E16330 NO VA EXP NOT AVBL NOT PROVIDED
16	Forecast height and position of the volcanic ash clouds (+12 HR)	FCST VA CLD +12 HR:	23/1300Z SFC/FL270 N4830 E16130 – N4830 E16600 – N5300 E16600 – N5300 E16130 – N4830 E16130 NO VA EXP NOT AVBL NOT PROVIDED
17	Forecast height and position of the volcanic ash clouds (+18 HR)	FCST VA CLD +18 HR:	23/1900Z NO VA EXP NOT AVBL NOT PROVIDED
18	Remarks	RMK:	LATEST REP FM KVERT (0120Z) INDICATES ERUPTION HAS CEASED. TWO DISPERSING VA CLD ARE EVIDENT ON SATELLITE IMAGERY RE-SUSPENDED VA ⁽¹⁾ NIL

¹ To be included (as free text) where space in the Remarks section allows.

19	Next advisory	NXT ADVISORY: 20080923/0730Z NO LATER THAN nnnnnnnn/nnnnZ NO FURTHER ADVISORIES WILL BE ISSUED BY nnnnnnnn/nnnnZ
----	---------------	--

Appendix 7

Regulation (EU) 2021/1338

Template for advisory for tropical cyclones

Key:

M = inclusion mandatory;

C = inclusion conditional, included whenever applicable;

O = inclusion optional;

= = a double line indicates that the text following it should be placed on the subsequent line.

Note 1: The ranges and resolutions for the numerical elements included in tropical cyclone advisory are shown in Appendix 8.

Note 2: The explanations for the abbreviations can be found in ICAO Doc 8400 Procedures for Air Navigation Services — ICAO Abbreviations and Codes (PANS-ABC).

Note 3: The inclusion of a colon (':') after each element heading is mandatory.

Note 4: Row numbers in the 'Ref.' column are included only for clarity and ease of reference, and are not part of the advisory for tropical cyclones.

Ref.	Element	Detailed content	Template(s)
1	Identification of the type of message (M)	Type of message	TC ADVISORY
2	New line		
3	Status indicator (C) ⁽¹⁾	Indicator of test or exercise	STATUS: TEST or EXER
4	New line		
5	Time of origin (M)	Year, month, day and time of issue in UTC	DTG: nnnnnnnn/nnnnZ
6	New line		
7	Name of TCAC (M)	Name of TCAC (location indicator or full name)	TCAC: nnnn or nnnnnnnnnn
8	New line		
9	Name of tropical cyclone (M)	Name of tropical cyclone or 'NN' for unnamed tropical cyclone	TC: nnnnnnnnnnnn or NN
10	New line		
11	Advisory number (M)	Advisory: Year in full and message number (separate sequence for each tropical cyclone)	ADVISORY NR: nnnn/[n][n][n]

¹ Used only when the message is issued to indicate that a test or an exercise is taking place. When the word 'TEST' or the abbreviation 'EXER' is included, the message may contain information that should not be used operationally or will otherwise end immediately after the word 'TEST'.

12	New line			
13	Observed position of the centre (M)	Day and time (in UTC) and position of the centre of the tropical cyclone (in degrees and minutes)	OBS PSN:	nn/nnnnZ Nnn[nn] or Snn[nn] Wnnn[nn] or Ennn[nn]
14	New line			
15	Observed CB cloud (O) ⁽¹⁾	Location of CB cloud (referring to the latitude and longitude (in degrees and minutes)) and vertical extent (flight level)	CB:	WI nnnKM (or nnnNM) OF TC CENTRE or WI ⁽²⁾ Nnn[nn] or Snn[nn] Wnnn[nn] or Ennn[nn] – Nnn[nn] or Snn[nn] Wnnn[nn] or Ennn[nn] – Nnn[nn] or Snn[nn] Wnnn[nn] or Ennn[nn] – [Nnn[nn] or Snn[nn] Wnnn[nn] or Ennn[nn]] – Nnn[nn] or Snn[nn] Wnnn[nn] or Ennn[nn]] TOP [ABV or BLW] FLnnn NIL
16	New line			
17	Direction and speed of movement (M)	Direction and speed of movement given in 16 compass points and km/h (or kt) respectively or stationary (< 2 km/h (1 kt))	MOV:	N nnKMH (or KT) or NNE nnKMH (or KT) or NE nnKMH (or KT) or ENE nnKMH (or KT) or E nnKMH (or KT) or ESE nnKMH (or KT) or SE nnKMH (or KT) or SSE nnKMH (or KT) or S nnKMH (or KT) or SSW nnKMH (or KT) or SW nnKMH (or KT) or WSW nnKMH (or KT) or W nnKMH (or KT) or WNW nnKMH (or KT) or NW nnKMH (or KT) or NNW nnKMH (or KT) or STNR
18	New line			
19	Changes in intensity (M)	Changes of maximum surface wind speed at time of observation	INTST CHANGE:	INTSF or WKN or NC
20	New line			
21	Central pressure (M)	Central pressure (in hPa)	C:	nnnHPA
22	New line			

¹ In the case of CB clouds associated with a tropical cyclone covering more than one area within the area of responsibility, this element can be repeated, as necessary.

² The number of coordinates should be kept to a minimum and should not normally exceed seven.

23	Maximum surface wind (M)	Maximum surface wind near the centre (mean surface wind over 10 minutes, in kt)	MAX WIND:	nn[n]KT
24	New line			
25	Forecast of centre position (+6 HR) (M)	Day and time (in UTC) (6 hours from the DTG given in Item 5); Forecast position (in degrees and minutes) of the centre of the tropical cyclone	FCST PSN +6 HR:	nn/nnnnZ Nnn[nn] or Snn[nn] Wnnn[nn] or Ennn[nn]
26	New line			
27	Forecast of maximum surface wind (+6 HR) (M)	Forecast of maximum surface wind (6 hours after the DTG given in Item 5)	FCST MAX WIND +6 HR:	nn[n]KT
28	New line			
29	Forecast of centre position (+12 HR) (M)	Day and time (in UTC) (12 hours from the DTG given in Item 5) Forecast position (in degrees and minutes) of the centre of the tropical cyclone	FCST PSN +12 HR:	nn/nnnnZ Nnn[nn] or Snn[nn] Wnnn[nn] or Ennn[nn]
30	New line			
31	Forecast of maximum surface wind (+12 HR) (M)	Forecast of maximum surface wind (12 hours after the DTG given in Item 5)	FCST MAX WIND +12 HR:	nn[n]KT
32	New line			
33	Forecast of centre position (+18 HR) (M)	Day and time (in UTC) (18 hours from the DTG given in Item 5) Forecast position (in degrees and minutes) of the centre of the tropical cyclone	FCST PSN +18 HR:	nn/nnnnZ Nnn[nn] or Snn[nn] Wnnn[nn] or Ennn[nn]
34	New line			
35	Forecast of maximum surface wind (+18 HR) (M)	Forecast of maximum surface wind (18 hours after the DTG given in Item 5)	FCST MAX WIND +18 HR:	nn[n]KT
36	New line			

37	Forecast of centre position (+24 HR) (M)	Day and time (in UTC) (24 hours from the DTG given in Item 5) Forecast position (in degrees and minutes) of the centre of the tropical cyclone	FCST PSN +24 HR:	nn/nnnnZ Nnn[nn] or Snn[nn] Wnnn[nn] or Ennn[nn]
38	New line			
39	Forecast of maximum surface wind (+24 HR) (M)	Forecast of maximum surface wind (24 hours after the DTG given in Item 5)	FCST MAX WIND +24 HR:	nn[n]KT
40	New line			
41	Remarks (M)	Remarks, as necessary	RMK:	Free text up to 256 characters or NIL
42	New line			
43	Expected time of issuance of next advisory (M)	Expected year, month, day and time (in UTC) of issuance of next advisory	NXT MSG:	[BFR] nnnnnnnn/nnnnZ or NO MSG EXP

GM1 to Appendix 7 ‘Template for advisory for tropical cyclones’

ED Decision 2022/004/R

ADVISORY FOR TROPICAL CYCLONES — EXAMPLES OF ELEMENTS

Non-exhaustive examples of the different elements used in the formulation of advisory for tropical cyclones are provided below.

Tropical cyclone advisory — examples of elements

Note 1: Consult the ‘Template for advisory for tropical cyclones’ ([Appendix 7 to Annex V \(Part-MET\)](#) to Regulation (EU) 2017/373) to identify the mandatory (M), the conditional (C) or the optional (O) elements.

Note 2: The ranges and resolutions for the numerical elements included in tropical cyclone advisory are provided in [Appendix 8 to Annex V \(Part-MET\)](#) to Regulation (EU) No 2017/373.

Note 3: The row numbers in the ‘Ref.’ column are included only for clarity and ease of reference, and are not part of the advisory for tropical cyclones. They do not correlate with the ‘Ref.’ column in the ‘Template for advisory for tropical cyclones’ of [Appendix 7 to Annex V \(Part-MET\)](#) to Regulation (EU) 2017/373. Refer to the ‘Element’ column when cross-referencing.

Ref.	Element	Examples
1	Identification of the type of message	TC ADVISORY
2	Status indicator	STATUS: TEST EXER
3	Time of origin	DTG: 20040925/1900Z
4	Name of TCAC	TCAC: YUFO MIAMI

5	Name of tropical cyclone	TC:	GLORIA
6	Advisory number	ADVISORY NR:	2004/13
7	Observed position of the centre	OBS PSN:	25/1800Z N2706 W07306
8	Observed CB cloud	CB:	WI 250NM OF TC CENTRE TOP FL500 NIL
9	Direction and speed of movement	MOV:	NW 20KMH
10	Changes in intensity	INTST CHANGE:	INTSF
11	Central pressure	C:	965HPA
12	Maximum surface wind	MAX WIND:	43KT
13	Forecast of centre position (+6 HR)	FCST PSN +6 HR:	25/2200Z N2748 W07350
14	Forecast of maximum surface wind (+6 HR)	FCST MAX WIND +6 HR:	43KT
15	Forecast of centre position (+12 HR)	FCST PSN +12 HR:	26/0400Z N2830 W07430
16	Forecast of maximum surface wind (+12 HR)	FCST MAX WIND +12 HR:	43KT
17	Forecast of centre position (+18 HR)	FCST PSN +18 HR:	26/1000Z N2852 W07500
18	Forecast of maximum surface wind (+18 HR)	FCST MAX WIND +18 HR:	41KT
19	Forecast of centre position (+24 HR)	FCST PSN +24 HR:	26/1600Z N2912 W07530
20	Forecast of maximum surface wind (+24 HR)	FCST MAX WIND +24 HR:	39KT
21	Remarks	RMK:	NIL
22	Expected time of issuance of next advisory	NXT MSG:	20040925/2000Z

Appendix 8

Regulation (EU) 2021/1338

Ranges and resolutions for the numerical elements included in volcanic ash advisory, tropical cyclone advisory, SIGMET, AIRMET, aerodrome and wind shear warnings

Note: Row numbers in the 'Ref.' column are included only for clarity and ease of reference, and are not part of the template.

Ref.	Elements		Range	Resolution
1	Summit elevation:	FT	000–27 000	1
		M	000–8 100	1
2	Advisory number:	for VA (index) ⁽¹⁾	000–2 000	1
		for TC (index) ⁽¹⁾	00–99	1
3	Maximum surface wind:	KT	00–99	1
4	Central pressure:	hPa	850–1 050	1
5	Surface wind speed:	KT	30–99	1
6	Surface visibility:	M	0000–0750	50
		M	0800–5 000	100
7	Cloud: height of base:	FT	000–1 000	100
8	Cloud: height of top:	FT	000–9 900	100
		FT	10 000–60 000	1000
9	Latitudes:	° (degrees)	00–90	1
		(minutes)	00–60	1
10	Longitudes:	° (degrees)	000–180	1
		(minutes)	00–60	1
11	Flight levels:		000–650	10
12	Movement:	KMH	0–300	10
		KT	0–150	5

⁽¹⁾ Non-dimensional.

ANNEX VI — PART-AIS

SPECIFIC REQUIREMENTS FOR THE PROVIDERS OF AERONAUTICAL INFORMATION SERVICES

SUBPART A – ADDITIONAL ORGANISATION REQUIREMENTS FOR PROVIDERS OF AERONAUTICAL INFORMATION SERVICES (AIS.OR)

SECTION 1 — GENERAL REQUIREMENTS

AIS.OR.100 Aeronautical information management

Commission Implementing Regulation (EU) 2020/469

An aeronautical information services (AIS) provider shall establish information management resources and processes that are adequate to ensure the timely collection, processing, storing, integration, exchange and delivery of quality- assured aeronautical data and aeronautical information within the ATM system.

GM1 AIS.OR.100 Aeronautical information management

ED Decision 2020/008/R

AERONAUTICAL INFORMATION

- (a) The object of aeronautical information services is to ensure the flow of aeronautical data and aeronautical information necessary for global air traffic management (ATM) system safety, regularity, economy and efficiency in an environmentally sustainable manner.
- (b) The role and importance of aeronautical data and aeronautical information changed significantly with the implementation of area navigation (RNAV), performance-based navigation (PBN), airborne computer-based navigation systems, performance-based communication (PBC), performance-based surveillance (PBS), data link systems and satellite voice communications (SATVOICE). Corrupt, erroneous, late, or missing aeronautical data and aeronautical information can potentially affect the safety of air navigation.
- (c) Guidance material on the organisation and operation of aeronautical information services is contained in ICAO Doc 8126 'Aeronautical Information Services Manual'.

AIS.OR.105 Responsibilities of aeronautical information services (AIS) providers

Commission Implementing Regulation (EU) 2020/469

An AIS provider shall ensure the provision of aeronautical data and aeronautical information necessary for the safety, regularity and efficiency of air navigation.

An AIS provider shall receive, collate or assemble, edit, format, publish, store and distribute aeronautical data and aeronautical information concerning the entire territory of a Member State as well as those areas over the high seas in which the Member State is responsible for the provision of air traffic services.

An AIS provider shall ensure that aeronautical data and aeronautical information are available for:

- (1) personnel involved in flight operations, including flight crews, flight planning, and flight simulators;
- (2) ATS providers responsible for flight information service, and
- (3) the services responsible for pre-flight information.

An AIS provider shall provide 24-hour services for NOTAM origination and issuance in its area of responsibility and for pre-flight information needed in relation to route stages originating at the aerodrome/heliport in its area of responsibility.

An AIS provider shall make available to other AIS providers aeronautical data and aeronautical information required by them.

An AIS provider shall ensure that procedures are in place to assess and mitigate safety risks to aviation arising from data and information errors.

An AIS provider shall clearly indicate that aeronautical data and aeronautical information provided for and on behalf of a Member State are provided under the authority of that Member State, irrespective of the format in which it is provided.

GM1 AIS.OR.105 Responsibilities of aeronautical information services providers

ED Decision 2020/008/R

AVAILABILITY OF AERONAUTICAL DATA AND AERONAUTICAL INFORMATION

An AIS provider is not obliged to provide data or information requested by other AIS providers when they are not available.

GM1 AIS.OR.105(1) Responsibilities of aeronautical information services (AIS) providers

ED Decision 2020/008/R

PERSONNEL INVOLVED IN FLIGHT OPERATIONS, INCLUDING FLIGHT CREWS, FLIGHT PLANNING, AND FLIGHT SIMULATORS

The data services (DAT) providers are considered as one of the entities or parties listed in AIS.OR.105(1). They also receive, assemble, translate, select, format, distribute and/or integrate aeronautical data and information that are released by an authoritative source for use in aeronautical databases on certified aircraft application/equipment.

GM1 AIS.OR.105(3) Responsibilities of aeronautical information services providers

ED Decision 2020/008/R

SERVICES RESPONSIBLE FOR PRE-FLIGHT INFORMATION

An AIS provider obtains aeronautical data and aeronautical information to provide pre-flight information service and to meet the need for in-flight information from:

- (a) the aeronautical information services of other States;
- (b) other sources that may be available.

SECTION 2 — DATA QUALITY MANAGEMENT

AIS.OR.200 General

Commission Implementing Regulation (EU) 2020/469

An AIS provider shall ensure that:

- (a) aeronautical data and aeronautical information are provided in accordance with the specifications laid down in the aeronautical data catalogue, specified in Appendix 1 to Annex III (Part-ATM/ANS.OR);
- (b) data quality is maintained; and
- (c) automation is applied to enable the processing and exchange of digital aeronautical data.

GM1 AIS.OR.200(a) General

ED Decision 2020/008/R

AERONAUTICAL DATA CATALOGUE

The aeronautical data catalogue presents the scope of data that can be collected and maintained by the AIS providers and provides a common terminology that can be used by data originators and service providers.

GM1 AIS.OR.200(b) General

ED Decision 2020/008/R

DATA QUALITY

The quality of data is a degree or level of confidence that the data provided meets the requirements of the user. Minimum requirements for the processing of aeronautical data may be found in the EUROCAE Document ED-76A ‘Standards for Processing Aeronautical Data’ which aims to assist aeronautical data chain actors and authorities in meeting their responsibilities. It is intended to be used by organisations seeking approval of the method(s) they use to process or manipulate data.

AMC1 AIS.OR.200(c) General

ED Decision 2020/008/R

AUTOMATED DATA PROCESSING

Where processes or parts of processes used in the origination, production, storage, handling, processing, transfer and distribution of aeronautical data and aeronautical information are subject to automation, they should be:

- (a) automated to a level commensurate with the context of the data process;
- (b) automated to optimise the allocation and interaction of human and machine to achieve a high degree of safety and quality benefits of the process;
- (c) automated to ensure traceability of the performed actions;
- (d) designed to avoid the introduction of data errors; and
- (e) designed to detect errors in received/input data.

AIS.OR.205 Formal arrangements

Commission Implementing Regulation (EU) 2020/469

An AIS provider shall ensure that formal arrangements are established with:

- (a) all parties transmitting data to them; and
- (b) other AIS providers, when exchanging aeronautical data and aeronautical information with them.

AMC1 AIS.OR.205 Formal arrangements

ED Decision 2020/008/R

MINIMUM CONTENT

Formal arrangements should include the following minimum content:

- (a) the aeronautical data to be provided;
- (b) the data quality requirements (DQRs) for each data item supplied according to the aeronautical data catalogue;
- (c) the method(s) for demonstrating that the data provided conforms with the specified requirements;
- (d) the action to be taken in the event of discovery of a data error or inconsistency in any data provided;
- (e) the following minimum criteria for notification of data changes:
 - (1) criteria for determining the timeliness of data provision based on the operational or safety significance of the change;
 - (2) any prior notice of expected changes; and
 - (3) the means to be adopted for notification;
- (f) the party responsible for documenting data changes;
- (g) data exchange details such as format or format change processes;
- (h) any limitations on the use of data;
- (i) requirements for the production of data origination quality reports;
- (j) metadata requirements; and
- (k) contingency requirements concerning the continuity of data provision.

AIS.OR.210 Exchange of aeronautical data and aeronautical information

Commission Implementing Regulation (EU) 2020/469

An AIS provider shall ensure that:

- (a) the format of aeronautical data is based on an aeronautical information exchange model designed to be globally interoperable; and
- (b) aeronautical data is exchanged through electronic means.

AMC1 AIS.OR.210(a) Exchange of aeronautical data and aeronautical information

ED Decision 2020/008/R

EXCHANGE MODEL

An AIS provider should use the aeronautical information exchange model (AIXM) to enable the management and distribution of aeronautical information services data in digital format.

GM1 AIS.OR.210(a) Exchange of aeronautical data and aeronautical information

ED Decision 2020/008/R

EXCHANGE MODEL

- (a) AIXM 5.1 is considered as being the minimum baseline for the exchange of aeronautical data and aeronautical information.
- (b) More information on the AIXM may be found under <http://www.aixm.aero/>.

GM2 AIS.OR.210(a) Exchange of aeronautical data and aeronautical information

ED Decision 2020/008/R

DIGITAL TERRAIN DATA

- (a) The existing formats for the exchange of electronic terrain datasets do not fully meet the requirements of the ISO 19100 series on geographic information, therefore the GeoTIFF format and Shape file with metadata is preferred.
- (b) The list of most used terrain formats can be found in Appendix D to the EUROCONTROL 'Terrain and Obstacle Data (TOD) Manual' (edition 2.2, dated 28 November 2019).

GM1 AIS.OR.210(b) Exchange of aeronautical data and information

ED Decision 2020/008/R

ELECTRONIC MEANS

The exchange of aeronautical data and aeronautical information may be done by a number of electronic exchanges avoiding the need of manual interaction with the data itself.

AIS.OR.215 Tools and software

Commission Implementing Regulation (EU) 2020/469

An AIS provider shall ensure that tools and software used to support or automate aeronautical data and aeronautical information processes perform their functions without adversely impacting on the quality of aeronautical data and aeronautical information.

GM1 AIS.OR.215 Tools and software

ED Decision 2020/008/R

SOFTWARE

- (a) A means by which AIS.OR.215 can be met, is through the verification of software applied to a known executable version of the software in its target operating environment.
- (b) The verification of software is a process for ensuring that the software meets the requirements for the specified application or intended use of the aeronautical data and aeronautical information.
- (c) The verification of software evaluates the output of an aeronautical data and/or aeronautical information software development process to ensure correctness and consistency with respect to the inputs and applicable software standards, rules and conventions used in that process.

GM2 AIS.OR.215 Tools and software

ED Decision 2020/008/R

TOOLS

Tools can be qualified meeting point 2.4.5 Aeronautical Data Tool Qualification of EUROCAE ED-76A/RTCA DO-200B ‘Standards for Processing Aeronautical Data’, dated June 2015.

AIS.OR.220 Validation and verification

Commission Implementing Regulation (EU) 2020/469

An AIS provider shall ensure that verification and validation techniques are employed so that the aeronautical data meets the associated data quality requirements (DQRs) specified in point [AIS.TR.200](#).

GM1 AIS.OR.220 Validation and verification

ED Decision 2020/008/R

GENERAL

- (a) Validation

Validation is the activity where a data element is checked as having a value that is fully applicable to the identity ascribed to the data element, or a set of data elements is checked as being acceptable for their intended use.

The application of validation techniques considers the entire aeronautical data chain. This includes the validation performed by prior data chain participants and any requirements levied on the data supplier. Providing data integrity has been assured, there is no need to repeat earlier validations as a matter of course.

Examples of validation techniques include the following:

- (1) Validation by application validates by applying data under test conditions. In certain cases, this may not be practical. Validation by application is considered to be the most effective form of validation. For example, flight inspection of final approach segment data prior to publication can be used to ensure that the published data is acceptable.

- (2) Logical consistency validates by comparing two different data sets or elements and identifying inconsistencies between values based on operative rules (e.g. business rules).
- (3) Semantic consistency validates by comparing data to an expected value or range of values for the data characteristics.
- (4) Validation by sampling evaluates a representative sample of data and applies statistical analysis to determine the confidence in the data quality.

(b) Verification

Verification is a process for checking the integrity of a data element whereby the data element is compared to another source, either from a different process or from a different point in the same process. While verification cannot ensure that the data is correct, it can be effective to ensure that the data has not been corrupted by the data process.

The application of verification techniques considers only the portion of the aeronautical data chain controlled by the organisation. Yet, verification techniques may be applied at multiple phases of the data processing chain.

Examples of verification techniques include the following:

- (1) Feedback testing is the comparison of a data set between its output and input state.
- (2) Independent redundancy testing involves processing the same data through two or more independent processes and comparing the data output of each process.
- (3) Update comparison involves comparison of updated data with its previous version. This comparison can identify all data elements that have changed. The list of changed elements can then be compared to a similar list generated by the supplier. A problem can be detected if an element is identified as changed on one list and not on the other.

AMC1 AIS.OR.220 Validation and verification

ED Decision 2020/008/R

DATA PROTECTION

- (a) The processes implemented to carry out validation and verification should define the means used to:
 - (1) verify received data and confirm that the data has been received without corruption;
 - (2) preserve data quality and ensure that stored data is protected from corruption; and
 - (3) confirm that originated data has not been corrupted prior to being stored.
- (b) Those processes should define the:
 - (1) actions to be taken when data fails a verification or validation check; and
 - (2) tools required for the verification and validation process.

AIS.OR.225 Metadata

Commission Implementing Regulation (EU) 2020/469

An AIS provider shall collect and preserve metadata.

GM1 AIS.OR.225 Metadata

ED Decision 2020/008/R

PERSONAL DATA

When collecting metadata, the protection of individuals with regard to the processing of personal data and with regard to the free movement of such data applies, in accordance with Regulation (EU) 2016/679 of the European Parliament and of the Council of 27 April 2016 on the protection of natural persons with regard to the processing of personal data and on the free movement of such data, and repealing Directive 95/46/EC (General Data Protection Regulation).

AIS.OR.230 Data error detection and authentication

Commission Implementing Regulation (EU) 2020/469

An AIS provider shall ensure that:

- (a) digital data error detection techniques are used during the transmission and/or storage of aeronautical data in order to support the applicable data integrity levels specified in point [AIS.TR.200\(c\)](#); and
- (b) the transfer of aeronautical data is subject to a suitable authentication process such that recipients are able to confirm that the data or information has been transmitted by an authorised source.

GM1 AIS.OR.230 Data error detection and authentication

ED Decision 2020/008/R

GENERAL

More explanation and guidance on data security, including data error detection and authentication, may be found in Section 2 of EUROCAE ED-76A.

DATA ERROR DETECTION

An example of a digital error detection technique is the use of cyclic redundancy checks (CRCs). Coding techniques can be effective regardless of the transmission media (e.g. computer disks, modem communication, or internet).

GM1 AIS.OR.230(a) Data error detection and authentication

ED Decision 2020/008/R

ERROR

The term 'error' is understood as being defective, degraded, lost, misplaced or corrupted data elements, or data elements not meeting stated quality requirements.

AIS.OR.235 Error reporting, error measurement, and corrective actions

Commission Implementing Regulation (EU) 2020/469

An AIS provider shall ensure that error reporting, error measurement and corrective action mechanisms are established and maintained.

GM1 AIS.OR.235 Error reporting, error measurement and corrective actions

ED Decision 2020/008/R

ERROR MANAGEMENT

- (a) An AIS provider should have a system for handling errors and anomalies identified both during data processing and after delivery of the data to the users.
- (b) All problems reported with the data should be analysed and any errors or anomalies documented and resolved or addressed.
- (c) All errors or anomalies detected in the data should be resolved or addressed prior to delivery.
- (d) Information concerning any errors in the data that have been delivered should be made available to all affected users.

AIS.OR.240 Data limitations

Commission Implementing Regulation (EU) 2020/469

An AIS provider shall identify, in the aeronautical information products, except for NOTAM, the aeronautical data and aeronautical information that do not meet the DQRs.

AIS.OR.250 Consistency requirement

Commission Implementing Regulation (EU) 2020/469

Where aeronautical data or aeronautical information is duplicated in the AIP of more than one Member State, the AIS providers responsible for those AIPs shall establish mechanisms to ensure consistency between the duplicated information.

AMC1 AIS.OR.250 Consistency requirement

ED Decision 2020/008/R

DUPLICATED INFORMATION

The AIS provider should ensure that:

- (a) coordination and explicit agreement are established with the AIS providers responsible for the aeronautical information publications (AIPs) of the States concerned before introducing changes in published border or cross-border data and information; and
- (b) periodic reviews are performed to detect inconsistencies between the AIPs of the States concerned.

GM1 AIS.OR.250 Consistency requirement

ED Decision 2020/008/R

DUPLICATED INFORMATION

- (a) Coordination and alignment processes between AIS providers should whenever possible be expanded beyond the AIP content and include all duplicated aeronautical data and information.
- (b) The AIS provider may identify and maintain a list of the data items and information which should be subject to coordination, for reference and use by its operational staff.
- (c) When establishing periodic reviews, the AIS provider may reflect those in formal arrangements established with other AIS providers.

SECTION 3 - AERONAUTICAL INFORMATION PRODUCTS

AIS.OR.300 General – Aeronautical information products

Commission Implementing Regulation (EU) 2020/469

When providing aeronautical data and aeronautical information in multiple formats, an AIS provider shall ensure that processes are implemented for data and information consistency between those formats.

GM1 AIS.OR.300 Aeronautical information products

ED Decision 2020/008/R

AERONAUTICAL DATA AND INFORMATION PROVIDED IN MULTIPLE FORMATS

‘Aeronautical data and information provided in multiple formats’ refers to aeronautical data and aeronautical information provided using different products, such as data sets, electronic or paper products.

CHAPTER 1 — AERONAUTICAL INFORMATION IN A STANDARDISED PRESENTATION

AIS.OR.305 Aeronautical information publication (AIP)

Commission Implementing Regulation (EU) 2020/469

An AIS provider shall issue an AIP.

AIS.OR.310 AIP amendments

Commission Implementing Regulation (EU) 2020/469

An AIS provider shall:

- (a) issue permanent changes to the AIP as AIP amendments; and
- (b) ensure that the AIP is amended or reissued at such regular intervals as necessary to ensure that the information is complete and up to date.

AIS.OR.315 AIP supplements

Commission Implementing Regulation (EU) 2020/469

An AIS provider shall:

- (a) issue, as AIP supplements, temporary changes of long duration – three months or longer – and information of short duration which contains extensive text and/or graphics;
- (b) regularly provide a checklist of the valid AIP supplements; and
- (c) publish a new AIP supplement as a replacement when an error occurs in an AIP supplement or when the period of validity of an AIP supplement is changed.

AIS.OR.320 Aeronautical information circular (AIC)

Commission Implementing Regulation (EU) 2020/469

An AIS provider shall issue as an AIC any of the following:

- (a) a long-term forecast of any major change in legislation, regulations, procedures or facilities;
- (b) information of a purely explanatory or advisory nature which affects flight safety;
- (c) information or notification of an explanatory or advisory nature, concerning technical, legislative or purely administrative matters.

An AIS provider shall review at least once a year the validity of an AIC in force.

AIS.OR.325 Aeronautical charts

Commission Implementing Regulation (EU) 2020/469

An AIS provider shall ensure that the following aeronautical charts, where made available:

- (a) form part of the AIP or are provided separately to recipients of the AIP:
 - (1) aerodrome obstacle chart – Type A;
 - (2) aerodrome/heliport chart;
 - (3) aerodrome ground movement chart;
 - (4) aircraft parking/docking chart;
 - (5) precision approach terrain chart;
 - (6) ATC surveillance minimum altitude chart;
 - (7) area chart;
 - (8) standard arrival chart – instrument (STAR);
 - (9) standard departure chart – instrument (SID);
 - (10) instrument approach chart;
 - (11) visual approach chart; and
 - (12) en-route chart; and
- (b) are provided as part of the aeronautical information products:
 - (1) aerodrome obstacle chart – Type B;
 - (2) world aeronautical chart 1:1 000 000;
 - (3) world aeronautical chart 1:500 000;
 - (4) aeronautical-navigation chart – small scale; and
 - (5) plotting chart.

AMC1 AIS.OR.325 Aeronautical charts

ED Decision 2020/008/R

PRODUCTION

Aeronautical charts should be produced in accordance with the specifications contained in ICAO Annex 4, Amendment No 61.

AIS.OR.330 NOTAM

Commission Implementing Regulation (EU) 2020/469

An AIS provider shall:

- (a) promptly issue a NOTAM whenever the information to be distributed is of a temporary nature and of short duration or when operationally significant permanent changes, or temporary changes of long duration, are made at short notice, except for extensive text and/or graphics; and
- (b) issue, as a NOTAM, information on the establishment, condition, or change of any aeronautical facility, service, procedure or hazard, the timely knowledge of which is essential to personnel involved with flight operations;

Compliance with point [AIS.OR.200](#) shall not inhibit the urgent distribution of aeronautical information necessary to ensure the safety of flight.

GM1 AIS.OR.330(a) NOTAM

ED Decision 2020/008/R

SHORT DURATION / SHORT NOTICE

- (a) The term ‘short duration’ should, in general, be understood as being less than 3 months.
- (b) The term ‘short notice’ should be understood as insufficient time for the AIS provider to distribute an AIP supplement or amendment.

GM1 AIS.OR.330(b) NOTAM

ED Decision 2020/008/R

TIMELY KNOWLEDGE

It may be considered that the knowledge of the information is ‘timely’ if it reaches the personnel involved with flight operations in time to ensure the safety, regularity and efficiency of flight operations.

GM2 AIS.OR.330(b) NOTAM

ED Decision 2020/008/R

EXCEPTIONAL SITUATIONS

- (a) It is recognised that, in the cases of NOTAM or digital NOTAM that are crucial to ensure the safety of flight, it is not always possible to comply with all the relevant provisions of the Regulation. However, it is also not possible to determine a priori all cases where this consideration may apply; this is dependent on a case-by-case individual assessment made by competent AIS staff.

- (b) If it is determined that it is not possible to comply with all the relevant provisions of the Regulation, the NOTAM office ensures, at the minimum, that:
- (1) the party originating the aeronautical data is authorised and/or an eligible/reasonable source;
 - (2) the content is plausible; and
 - (3) the DQRs are validated post publication, as soon as practicable.

CHAPTER 2 — DIGITAL DATA SETS

AIS.OR.335 General – Digital data sets

Commission Implementing Regulation (EU) 2020/469

If available, an AIS provider shall ensure that digital data is in the form of the following data sets:

- (1) AIP data set;
- (2) terrain data set;
- (3) obstacle data sets;
- (4) aerodrome mapping data sets; and
- (5) instrument flight procedure data sets.

When made available, terrain data shall be provided in the form of terrain data sets. A checklist of valid data sets shall be regularly provided.

GM1 AIS.OR.335(a) General — Digital data sets

ED Decision 2020/008/R

DATA SETS

Data items may appear in multiple data sets.

AIS.OR.340 Metadata requirements

Commission Implementing Regulation (EU) 2020/469

Each data set shall include a minimum set of metadata to be provided to the next user.

AIS.OR.345 AIP data set

Commission Implementing Regulation (EU) 2020/469

An AIS provider shall ensure that the AIP data set, if available, contains the digital representation of aeronautical information of lasting character, including permanent information and long-duration temporary changes.

GM1 AIS.OR.345 AIP data set

ED Decision 2020/008/R

GENERAL

The purpose of the AIP data set is to support the initial transition of the ATM domain towards the use of digital data sets instead of paper products. Therefore, its scope is defined considering the likelihood that the data contained in this set is actually being used in digital format by service providers, air traffic control and instrument flight rules/visual flight rules airspace users.

AIS.OR.350 Terrain and obstacle data – General requirements

Commission Implementing Regulation (EU) 2020/469

An AIS provider shall ensure that terrain and obstacle data, if available, are provided in accordance with point [AIS.TR.350](#).

GM1 AIS.OR.350 Terrain and obstacle data – General requirements

ED Decision 2020/008/R

GENERAL

- (a) Useful information for those organisations involved in the origination, processing and provision of digital terrain and obstacle data, from the point at which the need for origination is identified through to the point when the Member State makes it available in accordance with the requirements of ICAO Annex 15, can be found in the EUROCONTROL ‘Terrain and Obstacle Data (TOD) Manual’ (edition 2.2, dated 28 November 2019).
- (b) In addition, EUROCAE ED-98C ‘User Requirements For Terrain And Obstacle Data’ (October 2015) provides guidance for data gathering by data originators, for data processing by data integrators, for implementation by application integrators, and for end use by the aviation community (e.g. air carriers, air traffic services, procedure designers).

GM2 AIS.OR.350 Terrain and obstacle data – General requirements

ED Decision 2020/008/R

NAVIGATION APPLICATIONS

- (a) Terrain and obstacle data are intended to be used in air navigation applications such as:
 - (1) ground proximity warning system with forward-looking terrain avoidance function and minimum safe altitude warning (MSAW) system;
 - (2) determination of contingency procedures for use in the event of an emergency during a missed approach or take-off;
 - (3) aircraft operating limitations analysis;
 - (4) instrument procedure design (including circling procedure);
 - (5) determination of en-route ‘drift-down’ procedure and en-route emergency landing location;
 - (6) advanced surface movement guidance and control system (A-SMGCS); and
 - (7) aeronautical chart production and on-board databases.

Additional information on the use of terrain and obstacle data can be found in Appendix C to EUROCAE ED-98C.

- (b) The data may also be used in other applications such as flight simulator and synthetic vision systems, and may assist in determining the height restriction or removal of obstacles that pose a hazard to air navigation.

AIS.OR.355 Terrain data sets

Commission Implementing Regulation (EU) 2020/469

An AIS provider shall ensure that terrain data, if available, is provided:

- (a) for Area 1, as laid down in point [AIS.TR.350](#); and
- (b) for aerodromes to cover:
 - (1) Area 2a or parts thereof, as laid down in point [AIS.TR.350\(b\)\(1\)](#);
 - (2) Areas 2b, 2c and 2d or parts thereof, as laid down in points [AIS.TR.350\(b\)\(2\)](#), [\(3\)](#) and [\(4\)](#), for terrain:
 - (i) within 10 km from the aerodrome reference point (ARP); and
 - (ii) beyond 10 km from the ARP if the terrain penetrates the horizontal plane 120 m above the lowest runway elevation;
 - (3) the take-off flight path area or parts thereof;
 - (4) an area, or parts thereof, bounded by the lateral extent of the aerodrome obstacle limitation surfaces;
 - (5) Area 3 or parts thereof, as laid down in point [AIS.TR.350\(c\)](#), for terrain that extends 0.5 m above the horizontal plane, passing through the nearest point on the aerodrome movement area; and
 - (6) Area 4 or parts thereof, as laid down in point [AIS.TR.350\(d\)](#), for all runways where precision approach Category II or III operations have been established and where detailed terrain information is required by operators to enable them to assess the effect of terrain on decision height determination by use of radio altimeters.

GM1 AIS.OR.355 Terrain data sets

ED Decision 2020/008/R

ADDITIONAL TERRAIN DATA

Where additional terrain data is collected to meet other aeronautical requirements, the terrain data sets may be expanded to include this additional data.

GM1 AIS.OR.355(b)(3) Terrain data sets

ED Decision 2020/008/R

TAKE-OFF FLIGHT PATH AREA

‘Take-off flight path area’ is defined in 3.8.2 of ICAO Annex 4.

GM1 AIS.OR.355(b)(4) Terrain data sets

ED Decision 2020/008/R

AERODROME OBSTACLE LIMITATION SURFACES

‘Aerodrome obstacle limitation surfaces’ are defined in Chapter H – Obstacle Limitation Surfaces of Regulation (EU) No 139/2014.

AIS.OR.360 Obstacle data sets

Commission Implementing Regulation (EU) 2020/469

An AIS provider shall ensure that obstacle data, if available, is provided:

- (a) for obstacles in Area 1 whose height is 100 m or higher above ground;
- (b) for aerodromes, for all obstacles within Area 2 that are assessed as being a hazard to air navigation; and
- (c) for aerodromes, to cover:
 - (1) Area 2a or parts thereof, for those obstacles that penetrate the relevant obstacle data collection surface;
 - (2) objects in the take-off flight path area or parts thereof, which project above a plane surface having a 1,2 % slope and having a common origin with the take-off flight path area;
 - (3) penetrations of the aerodrome obstacle limitation surfaces or parts thereof;
 - (4) Areas 2b, 2c and 2d, for obstacles that penetrate the relevant obstacle data collection surfaces;
 - (5) Area 3 or parts thereof, for obstacles that penetrate the relevant obstacle data collection surface; and
 - (6) Area 4 or parts thereof, for all runways where precision approach Category II or III operations have been established.

GM1 AIS.OR.360 Obstacle data sets

ED Decision 2020/008/R

ADDITIONAL OBSTACLE DATA

Where additional obstacle data is collected to meet other aeronautical requirements, the obstacle data sets may be expanded to include this additional data.

AIS.OR.365 Aerodrome mapping data sets

Commission Implementing Regulation (EU) 2020/469

An AIS provider shall ensure that aerodrome mapping data sets, if available, are provided in accordance with point [AIS.TR.365](#).

AIS.OR.370 Instrument flight procedure data sets

Commission Implementing Regulation (EU) 2020/469

An AIS provider shall ensure that instrument flight procedure data sets, if available, are provided in accordance with point [AIS.TR.370](#).

SECTION 4 — DISTRIBUTION AND PRE-FLIGHT INFORMATION SERVICES

AIS.OR.400 Distribution services

Commission Implementing Regulation (EU) 2020/469

An AIS provider shall:

- (a) distribute available aeronautical information products to those users who request them;
- (b) make available the AIP, AIP amendments, AIP supplements, NOTAM and AIC by the most expeditious means;
- (c) ensure that NOTAM are distributed through the aeronautical fixed service (AFS), whenever practicable;
- (d) ensure that international exchange of NOTAM takes place only as mutually agreed between the international NOTAM offices and multinational NOTAM processing units concerned; and
- (e) arrange, as necessary, the issuance and receipt of NOTAM distributed by telecommunication to satisfy operational requirements.

GM1 AIS.OR.400(a) Distribution services

ED Decision 2020/008/R

DELIVERY METHOD

- (a) The distribution of available aeronautical information products to the intended users differs in the delivery method applied which may either be:
 - (1) physical distribution — the means by which aeronautical data and aeronautical information distribution is achieved through the delivery of a physical package, such as postal services; or
 - (2) direct electronic distribution — the means by which aeronautical data and aeronautical information distribution is achieved automatically through the use of a direct electronic connection between the AIS provider and the intended user.
- (b) Different delivery methods and data media may require different procedures to ensure the required data quality.
- (c) Further guidance on digital dataset distribution can be found in ICAO Doc 10039 'Manual on System Wide Information Management (SWIM) Concept'.
- (d) Global communication networks and web services may be employed for the provision of aeronautical information products.
- (e) Guidance to assist the AIS providers in developing and adapting their systems for the distribution of the State AIP on the internet as an official and authoritative source of information may be found in the EUROCONTROL 'Guidelines for Aeronautical Information Publication (AIP) distribution on the Internet' (edition 1.0, dated October 2017).

AIS.OR.405 Pre-flight information services

Commission Implementing Regulation (EU) 2020/469

An AIS provider shall ensure that:

- (a) for any aerodrome/heliport, aeronautical information relative to the route stages originating at the aerodrome/heliport is made available to flight operations personnel, including flight crew and services responsible for pre-flight information; and
- (b) aeronautical information provided for pre-flight planning purposes includes information of operational significance from the elements of the aeronautical information products.

GM1 AIS.OR.405(a) Pre-flight information services

ED Decision 2020/008/R

COMMUNICATION

Pre-flight information may be provided as a verbal briefing or a self-briefing.

GM1 AIS.OR.405(b) Pre-flight information services

ED Decision 2020/008/R

OPERATIONAL SIGNIFICANCE

- (a) Geographic coverage for pre-flight information services should be determined and periodically reviewed. In general, the coverage zone should be limited to the flight information region (FIR) within which the aerodrome/heliport is located, the FIR(s) adjacent thereto, and all air route or portion of route flown without an intermediate landing, originating at the aerodrome/heliport and extending beyond the FIR(s) mentioned.
- (b) The elements of the aeronautical information products may be limited to national publications and when practicable, those of immediately adjacent States, provided that a complete library of aeronautical information is available at a central location and means of direct communications with that library are available.
- (c) A recapitulation of valid NOTAM of operational significance and other information of urgent character can be made available to flight crews in the form of plain-language pre-flight information bulletins (PIBs).
- (d) Guidance on the preparation of pre-flight information services and PIBs may be found in Chapter 8 of ICAO Doc 8126 'Aeronautical Information Services Manual' and in Chapter 7 of the EUROCONTROL 'Guidelines — Operating Procedures for AIS Dynamic Data (OPADD)' (edition:4.0, dated 17 April 2015).

SECTION 5 — AERONAUTICAL INFORMATION PRODUCTS UPDATES

AIS.OR.500 General – Aeronautical information products updates

Commission Implementing Regulation (EU) 2020/469

An AIS provider shall ensure that aeronautical data and aeronautical information are amended or reissued to keep them up to date.

AIS.OR.505 Aeronautical information regulation and control (AIRAC)

Commission Implementing Regulation (EU) 2020/469

An AIS provider shall ensure that information concerning the circumstances listed in point [AIS.TR.505\(a\)](#) is distributed under the AIRAC system.

An AIS provider shall ensure that:

- (1) the information notified under the AIRAC system is not changed further for at least another 28 days after the AIRAC effective date unless the circumstance notified is of a temporary nature and would not persist for the full period;
- (2) the information provided under the AIRAC system is distributed/made available so as to reach recipients at least 28 days in advance of the AIRAC effective date; and
- (3) implementation dates other than the AIRAC effective dates are not used for pre-planned operationally significant changes requiring cartographic work and/or for updating of navigation databases.

GM1 AIS.OR.505 Aeronautical information regulation and control (AIRAC)

ED Decision 2020/008/R

AIRAC SYSTEM

Further explanations with regard to the application of the AIRAC system can be found in the EUROCONTROL 'Procedure for the Assessment of Information for Notification by AIRAC' (SDP/8), (edition 2.0, dated 17 July 2009). Additional details can be found in SDP/9, 10 and 13 for specific products.

AMC1 AIS.OR.505(2) Aeronautical information regulation and control (AIRAC)

ED Decision 2020/008/R

DISTRIBUTION

AIRAC information, distributed as a physical medium, should be sent at least 42 days in advance of the AIRAC effective dates with the objective of reaching recipients at least 28 days in advance of the effective date.

AIS.OR.510 NOTAM

Commission Implementing Regulation (EU) 2020/469

An AIS provider shall:

- (a) ensure that NOTAM are provided in accordance with point [AIS.TR.510](#); and
- (b) provide a ‘trigger NOTAM’, as laid down in point [AIS.TR.510\(f\)](#), when an AIP amendment or an AIP supplement is published in accordance with AIRAC procedures.

AIS.OR.515 Data set updates

Commission Implementing Regulation (EU) 2020/469

An AIS provider shall:

- (a) amend or reissue data sets at such regular intervals as may be necessary to keep them up to date; and
- (b) issue permanent changes and temporary changes of long duration – three months or longer – made available as digital data in the form of a complete data set and/or a subset that includes only the differences from the previously issued complete data set.

AMC1 AIS.OR.515 Data set updates

ED Decision 2020/008/R

GENERAL

- (a) When made available as a completely re-issued data set, the differences from the previously issued complete data set should be indicated.
- (b) When temporary changes of short duration are made available as digital data, they should use the same information model as the complete data set.

SECTION 6 — PERSONNEL REQUIREMENTS

AIS.OR.600 General requirements

Commission Implementing Regulation (EU) 2020/469

In addition to point [ATM/ANS.OR.B.005\(a\)\(6\)](#) of Annex III, the AIS provider shall ensure that personnel responsible for the provision of aeronautical data and aeronautical information is:

- (a) made aware of and applies the following:
 - (1) the requirements on aeronautical information products and services, as specified in Sections 2 to 5;
 - (2) the update cycles applicable to the issuing of AIP amendments and AIP supplements for the areas for which they provide aeronautical data or aeronautical information;
- (b) adequately trained, competent and authorised for the job they are required to do.

GM1 AIS.OR.600(b) General requirements

ED Decision 2020/008/R

COMPETENCE

‘Competence’ is understood as a situation where the personnel responsible for originating aeronautical data and aeronautical information possess the required level of knowledge, technical and behavioural skills and experience, and language proficiency when required, in order to be authorised to perform their duties.

AUTHORISATION

The authorisation of personnel is usually granted by the AIS provider, but it might be granted by another entity depending on the national arrangements for managing the competence and performance of AIS personnel.

SUBPART B — TECHNICAL REQUIREMENTS FOR PROVIDERS OF AERONAUTICAL INFORMATION SERVICES (AIS.TR)

SECTION 2 - DATA QUALITY MANAGEMENT

AIS.TR.200 General

Commission Implementing Regulation (EU) 2020/469

- (a) The accuracy of aeronautical data shall be as specified in the aeronautical data catalogue ('data catalogue'), specified in [Appendix 1 to Annex III](#) (Part-ATM/ANS.OR).
- (b) The resolution of aeronautical data shall be commensurate with the actual data accuracy.
- (c) The integrity of aeronautical data shall be maintained. Based on the integrity classification specified in the data catalogue, procedures shall be put in place so that:
 - (1) for routine data, corruption is avoided throughout the processing of the data;
 - (2) for essential data, corruption does not occur at any stage of the entire process and additional processes are included, as needed, to address potential risks in the overall system architecture to further assure data integrity at this level;
 - (3) for critical data, corruption does not occur at any stage of the entire process and additional integrity assurance processes are included to fully mitigate the effects of faults identified by thorough analysis of the overall system architecture as potential data integrity risks.
- (d) The traceability of aeronautical data shall be ensured.
- (e) The timeliness of the aeronautical data shall be ensured, including any limits on the effective period of the data.
- (f) The completeness of the aeronautical data shall be ensured.
- (g) The format of delivered data shall be adequate to ensure that the data is interpreted in a manner that is consistent with its intended use.

GM1 AIS.TR.200(b) General

ED Decision 2020/008/R

ACCURACY — RESOLUTION

- (a) The resolution of the data contained in the database may be the same or finer than the publication resolution.
- (b) Stating that resolution needs to be commensurate with the accuracy means that digital data needs to have sufficient resolution to maintain accuracy. Typically, if an accuracy of .1 units is needed, then a resolution of 0.01 or .001 units would enable a data chain to preserve the accuracy without problems. A finer resolution could be misleading as one could assume that it supports a finer accuracy. This factor range of 10 to 100 between accuracy and resolution is applicable regardless of the units of measurements used.

AMC1 AIS.TR.200(d) General

ED Decision 2020/008/R

TRACEABILITY

Aeronautical data and associated metadata should be kept for a minimum period of 5 years beyond the validity period of the associated aeronautical information.

AIS.TR.210 Exchange of aeronautical data and aeronautical information

Commission Implementing Regulation (EU) 2020/469

Except for terrain data, the exchange format of aeronautical data shall:

- (a) enable the exchange of data for both individual features and feature collections;
- (b) enable the exchange of baseline information as a result of permanent changes;
- (c) be structured in accordance with the subjects and properties of the aeronautical data catalogue, and be documented through a mapping between the exchange format and the aeronautical data catalogue.

AMC1 AIS.TR.210 Exchange of aeronautical data and aeronautical information

ED Decision 2020/008/R

EXCHANGE MODELS

- (a) The exchange model used should encompass the aeronautical data and aeronautical information to be exchanged.
- (b) The exchange model used should:
 - (1) use the unified modelling language (UML) to describe the aeronautical information features and their properties, associations and data types;
 - (2) include data value constraints and data verification rules;
 - (3) include provisions for metadata;
 - (4) include a temporality model to enable capturing the evolution of the properties of an aeronautical information feature during its life cycle;
 - (5) apply a commonly used data encoding format;
 - (6) cover all the features, attributes, data types and associations of the aeronautical information model; and
 - (7) provide an extension mechanism by which groups of users can extend the properties of existing features and add new features which do not adversely affect global standardisation.

GM1 to AMC1 AIS.TR.210 Exchange of aeronautical data and aeronautical information

ED Decision 2020/008/R

ENABLING EXCHANGE

- (a) The intent of using a commonly used data encoding format is to ensure interoperability of aeronautical data exchange between agencies and organisations involved in the data processing chain.
- (b) Examples of commonly used data encoding formats include extensible markup language (XML), geography markup language (GML), and JavaScript object notation (JSON).

AIS.TR.220 Verification

Commission Implementing Regulation (EU) 2020/469

- (a) The verification shall ensure that:
 - (1) the aeronautical data was received without corruption;
 - (2) the aeronautical data process does not introduce corruption.
- (b) Aeronautical data and aeronautical information entered manually shall be subject to independent verification to identify any errors that may have been introduced.

AIS.TR.225 Metadata

Commission Implementing Regulation (EU) 2020/469

The metadata to be collected shall include, as a minimum:

- (a) the identification of the organisations or entities performing any action of originating, transmitting or manipulating the aeronautical data;
- (b) the action performed;
- (c) the date and time the action was performed.

AMC1 AIS.TR.225(a) Metadata

ED Decision 2020/008/R

IDENTIFICATION

The metadata collected should clearly identify the organisation or entity originating the data, as well as any organisation or entity introducing amendments to the data.

AMC1 AIS.TR.225(b) Metadata

ED Decision 2020/008/R

ACTION PERFORMED

The metadata reflecting each action performed involving origination or manipulation of the data should reflect any potential impact on the compliance with the applicable DQRs.

GM1 AIS.TR.225 Metadata

ED Decision 2020/008/R

GENERAL

Further explanation on the schema required for describing geographic information and services by means of metadata may be found in the:

- (a) International Organization for Standardization, ISO 19115 — Geographic information — Metadata, Part I; and
- (b) EUROCONTROL 'Guidelines for the provision of Metadata to support the Exchange of Aeronautical Data' (edition 1.0, dated 28 November 2019)

AIS.TR.235 Error reporting, error measurement and corrective actions

Commission Implementing Regulation (EU) 2020/469

The error reporting, error measurement and corrective mechanisms shall ensure that:

- (a) problems identified during origination, production, storage, handling and processing, or those reported by users after publication, are recorded;
- (b) all problems reported in relation to the aeronautical data and aeronautical information are analysed by the AIS provider and the necessary corrective actions are performed;
- (c) priority is given to resolution of all errors, inconsistencies and anomalies detected in critical and essential aeronautical data;
- (d) affected users are warned of errors by the most effective means, taking into account the integrity level of the aeronautical data and aeronautical information;
- (e) error feedback is facilitated and encouraged.

AIS.TR.240 Data limitations

Commission Implementing Regulation (EU) 2020/469

The identification of data not meeting the DQRs shall be made with an annotation or by explicitly providing the quality value.

GM1 AIS.TR.240 Data limitations

ED Decision 2020/008/R

ANNOTATION

- (a) The objective of such an annotation is to notify the users of the AIS products including their aeronautical data that specific quality requirements are not met and may, therefore, compel limitations in the operational use of the relevant aeronautical data.
- (b) The following principles apply:
 - (1) the solution applies for both the eAIP and paper AIP;
 - (2) the use of the 'asterisk' is undesirable because it is already used for WGS-84 issues;
 - (3) the non-compliance covers all parts of the AIP, i.e. textual aeronautical data and charts; and

- (4) non-compliant aeronautical data items shall be individually and explicitly identified and the use of any general statement with the intention of covering a range of data items shall be avoided.
- (c) The AIP section GEN 1.7 is used to identify non-compliant aeronautical data items. A new sub-header should be introduced at the end of the current section named ‘Data non-compliant with European Commission Regulation (EU) 2017/373’.
- (d) Within AIP GEN 1.7, the following two alternatives are proposed. The choice of which depends on national practicalities being based either on the amount of annotations to be published or on individual existing operational or technical constraints.

(1) Annotation alternative 1

Alternative 1 is recommended if the number of identified non-compliances covers no more than two AIP pages.

The relevant non-compliant data items shall be listed in a table, including as a minimum:

- specific data item;
- AIP section(s) concerned;
- reason for non-compliance;
- Notes/remarks.

Proposed table format:

Data Item	AIP section	Reason for non-compliance	Notes/remarks

(2) Annotation alternative 2

Alternative 2 is recommended if the number of non-compliances extends more than two AIP pages. It should then contain a general (global) statement to indicate ‘Several data items are not compliant with the given regulation – details can be found online via <link>’. The link shall direct the user to a list on the website which must support compliance with minimum requirements: the list must be accessible online.

Note: The indication of ‘available on request’, or similar, is clearly insufficient. The list must be kept up to date and fully synchronised (consistent) with the AIP update cycles, as relevant. This list should be in the form of a table as indicated under alternative 1 noting that it will be made available to users as an extra element outside the AIP.

SECTION 3 - AERONAUTICAL INFORMATION PRODUCTS

AIS.TR.300 General – Aeronautical information products

Commission Implementing Regulation (EU) 2020/469

- (a) Aeronautical information products intended for distribution shall include English text for those parts expressed in plain language, except those products intended to be distributed solely within a Member State.
- (b) Place names shall be spelt in conformity with local usage and transliterated, when necessary, into the International Organization for Standardization (ISO) basic Latin alphabet.
- (c) International Civil Aviation Organization (ICAO) abbreviations shall be used in the aeronautical information products whenever they are appropriate.

GM1 AIS.TR.300(b) General — Aeronautical information products

ED Decision 2020/008/R

PLACE NAMES

The phrase ‘when necessary’ means ‘for interoperability purposes’ e.g. in aeronautical information products that are intended to be processed by automated systems (NOTAM, data sets, etc.).

CHAPTER 1 – AERONAUTICAL INFORMATION IN A STANDARDISED PRESENTATION

AIS.TR.305 Aeronautical information publication (AIP)

Commission Implementing Regulation (EU) 2020/469

- (a) The AIP, AIP amendments and AIP supplements shall be provided as an ‘electronic AIP’ (eAIP). The eAIP shall allow for displaying on computer screen and printing on paper. In addition, the AIP, AIP amendments and AIP supplements may also be provided on paper.
- (b) The AIP shall include:
 - (1) a statement of the competent authority responsible for the air navigation facilities, services or procedures covered by the AIP;
 - (2) the general conditions under which the services or facilities are available for use;
 - (3) a list of significant differences between the regulations and practices of the Member State and the related ICAO Standards and Recommended Practices (SARPs) and Procedures;
 - (4) the choice made by a Member State in each significant case where an alternative course of action is provided for in the ICAO SARPs and procedures.
- (c) The AIP shall contain information related to, and arranged under, the subject headings listed in [Appendix 1](#).
- (d) The issuing Member State and AIS provider shall be clearly indicated.
- (e) When two or more Member States jointly provide an AIP, they shall be clearly indicated.
- (f) Each AIP shall be self-contained and include a table of contents.

- (g) An AIP shall be organised in three parts (GEN, ENR and AD), sections and subsections, except when the AIP, or a volume of the AIP, is designed to facilitate operational use in-flight, in which case the precise format and arrangement may be left to the discretion of the Member State provided that an adequate table of contents is included.
- (h) Each AIP shall be dated.
- (i) The date, consisting of the day, month (by name), and year, shall be the publication date and/or the effective date (AIRAC) of the information.
- (j) When describing periods of activity, availability or operation, the applicable days and times shall be specified.
- (k) Each AIP issued as a printed volume and each page of an AIP issued in a loose-leaf form shall be annotated to clearly indicate:
 - (1) the identity of the AIP;
 - (2) the territory covered and its subdivisions, when necessary;
 - (3) the identification of the issuing Member State and producing organisation (authority); and
 - (4) page numbers/chart titles.
- (l) Any amendment to the printed volume of the AIP shall be made using replacement sheets.

AMC1 AIS.TR.305(a) Aeronautical information publication (AIP)

ED Decision 2020/008/R

ELECTRONIC FORM

The eAIP, eAIP amendments and eAIP supplements should be provided according to the EUROCONTROL 'Specification for the Electronic Aeronautical Information Publication (eAIP)' (edition 2.1, dated 6 October 2015).

AMC2 AIS.TR.305(a) Aeronautical information publication (AIP)

ED Decision 2020/008/R

ELECTRONIC AIP

When provided, the eAIP should be available on a physical distribution medium (CD, DVD, etc.) and/or online on the internet.

GM1 AIS.TR.305(a) Aeronautical information publication (AIP)

ED Decision 2020/008/R

PRINTED AIP

- (a) A system of page numbering adaptable to the addition or deletion of sheets should be adopted. The page number should include:
 - (1) an identification of the part of the AIP;
 - (2) the section; and
 - (3) subsection, as applicable,

thus creating a separate set of numbers for each subject (e.g. GEN 2.1-3, ENR 4.1-1 or AD 2.2-3).

- (b) If it is necessary by reason of bulk or for convenience, to publish an AIP in two or more parts or volumes, each of them will indicate that the remainder of the information is to be found in the other part(s) or volume(s).
- (c) When the AIP is provided in more than one volume, each volume should include:
 - (1) a preface;
 - (2) a record of AIP amendments;
 - (3) a record of AIP supplements;
 - (4) a checklist of AIP pages; and
 - (5) a list of current hand amendments.
- (d) When the AIP is published as one volume, the above-mentioned subsections should appear only in Part 1 — GEN and the annotation ‘not applicable’ should be entered against each of these subsections in Parts 2 and 3.
- (e) The AIP should be published in loose-leaf form unless the complete publication is reissued at frequent intervals.
- (f) Further guidelines for a harmonised AIP publication may be found in the EUROCONTROL ‘Guidelines for harmonised AIP publication and data set provision’ (edition 2.0, dated 23 May 2019).

AMC1 AIS.TR.305(c) Aeronautical information publication (AIP)

ED Decision 2022/015/R

INFORMATION PUBLISHED UNDER ‘AD 1.2.2 RUNWAY SURFACE CONDITION ASSESSMENT AND REPORTING, AND SNOW PLAN’

The following information, originated by the competent authority, should be published under AD 1.2.2 for all aerodromes open to public use in the State:

1. Organisation of the runway surface condition reporting and the winter service
An indication of the:
 - organisation responsible for snow clearance and for assessing, improving and reporting runway surface conditions;
 - general policy concerning operational priorities established for the clearance of movement areas;
 - general policy concerning trend monitoring of surface friction characteristics, and what constitutes a complete survey.
2. Surveillance of movement areas
Indication of how surveillance of the movement areas is organised.
3. Surface condition assessment methods used; operations on specially prepared winter runways

Assessment methods and measurements taken. Reference should be made to the use of the runway condition assessment matrix, including the case of specially prepared winter runways, in the case the use of such runways has been approved.

4. Actions taken to maintain the usability of movement areas

A brief description of the methods used for clearing snow, slush, ice and standing water, e.g. plowing, sweeping or blowing, and details of any chemical methods employed for clearing movement areas. Information concerning when and how surface friction characteristics will be improved. General policy concerning coordination between aerodrome operators, air traffic services providers and the competent authorities to ensure compatibility between efficient snow clearance procedures and maximum utilisation of the aerodrome.

5. System and means of reporting

Reference should be made to the runway condition report.

6. The cases of runway closure

Indication of the general policy on closure of a runway.

7. Distribution of information about runway surface conditions

A short description of the system for distribution of information (NOTAM) for runways reaching the minimum friction value (slippery wet runways). Reference should be made to when NOTAMs for slippery wet runways are issued and updated.

A short description of the system for distribution of information about runway surface conditions (SNOWTAM, automatic terminal information service (ATIS) updating). Reference should be made to when SNOWTAMs are issued and updated. Furthermore, a description should be provided of how the upgraded/downgraded information is included in the SNOWTAM. In addition, a statement should be included when the information is disseminated with ATIS only.

AMC2 AIS.TR.305(c) Aeronautical information publication (AIP)

ED Decision 2022/015/R

INFORMATION PUBLISHED UNDER 'AD 2.7 RUNWAY SURFACE CONDITION ASSESSMENT AND REPORTING AND SNOW PLAN'

The following information, originated by the respective aerodrome operator, should be published under AD 2.7.

- (a) A reference to the content of AD.1.2.2 should be made for the runway surface condition assessment and reporting. Additional, aerodrome-specific information on runway surface condition assessment and reporting, complementing the information contained in AD 1.2.2 should be included.
- (b) A detailed description of the equipment and operational priorities established for the clearance of aerodrome movement areas should be given, including:
 1. Type(s) of clearing equipment

Indication as to whether the aerodrome is serviceable during all seasons of the year and, if not, the periods (months of the year) during which it may be unserviceable or must be used with caution, indicating the likely cause of unserviceability and the precautions to be taken. Information relating to snow removal should include:

- (i) where no snow removal equipment is required, 'Not applicable' should be indicated;
 - (ii) where snow conditions exist, the types of equipment used should be indicated.
2. Clearance priorities
Indication of the priorities with regard to clearing of runway(s), taxiway(s) and apron(s).
3. Use of material for movement area surface treatment
Indication of the type of material used for movement area surface treatment, using the abbreviation/text or the material.
Where no material is used, 'Not applicable' should be indicated.
4. Specially prepared winter runways
Indication if specially prepared winter runways have been approved, including runway designators.
Where the use of specially prepared winter runways has not been approved, 'Not applicable' should be indicated.
5. Remarks
Any other relevant information not covered under this subsection.

AMC3 AIS.TR.305(c) Aeronautical information publication (AIP)

ED Decision 2022/015/R

INFORMATION FOR LED LIGHTS PUBLISHED UNDER 'AD 2.14 APPROACH AND RUNWAY LIGHTING'

If the aerodrome operator provides information that light emitting diode (LED) lights are used as part of the approach and runway lighting system of the aerodrome, such information should be published in the 'Remarks'. In such case, the information published should make clear, for each part of the lighting system, whether:

- LED lights are exclusively used for that part of the lighting system; or
- LED lights are used in combination with incandescent lights.

AMC4 AIS.TR.305(c) Aeronautical information publication (AIP)

ED Decision 2022/015/R

INFORMATION FOR VISUAL SEGMENT SURFACE (VSS) PENETRATION, PUBLISHED UNDER 'AD 2.25'

If the VSS is penetrated, the information to be published under this section should clearly indicate the name of the affected procedure and the procedure minima affected.

The published information should be grouped per runway end.

In the case of no penetration, 'Not applicable' should be indicated.

GM1 AIS.TR.305(c) Aeronautical information publication (AIP)

ED Decision 2020/008/R

INFORMATION RELATED TO LOCATIONS

When listing locations, the city or town should be given in capital letters followed, where the facility is an aerodrome/heliport or is located at an aerodrome/heliport, by an oblique stroke and the name of the aerodrome/heliport in smaller capital letters or lower-case letters. Unless otherwise indicated, the list should be in alphabetical order.

GM2 AIS.TR.305(c) Aeronautical information publication (AIP)

ED Decision 2020/008/R

INFORMATION RELATED TO CHARTS, MAPS OR DIAGRAMS

- (a) Charts, maps or diagrams should be used, when appropriate, to complement the AIP or serve as a substitute for the tabulations or text of the AIP.
- (b) Where appropriate, charts produced in conformity with AIS.OR.325 may be used to fulfil this requirement.

GM3 AIS.TR.305(c) Aeronautical information publication (AIP)

ED Decision 2022/015/R

INFORMATION RELATED TO THE AIP DATA SET

When the AIP data set is provided, the following sections of the AIP may be left blank and a reference to the data set availability should be provided:

- (a) ENR 2.1 FIR, UIR, TMA and CTA;
- (b) ENR 3.1 Conventional navigation routes;
- (c) ENR 3.2 Area navigation routes;
- (d) ENR 3.3 Other routes;
- (e) ENR 3.4 En route holding;
- (f) ENR 4.1 Radio navigation aids — en route;
- (g) ENR 4.4 Name-code designators for significant points;
- (h) ENR 4.5 Aeronautical ground lights — en route;
- (i) ENR 5.1 Prohibited, restricted and danger areas;
- (j) ENR 5.2 Military exercise and training areas and air defence identification zone (ADIZ);
- (k) ENR 5.3.1 Other activities of a dangerous nature;
- (l) ENR 5.5 Aerial sporting and recreational activities;
- (m) AD 2.17 Air traffic services airspace;
- (n) AD 2.19 Radio navigation and landing aids;
- (o) AD 3.16 Air traffic services airspace; and
- (p) AD 3.18 Radio navigation and landing aids.

GM4 AIS.TR.305(c) Aeronautical information publication (AIP)

ED Decision 2020/008/R

INFORMATION RELATED TO THE OBSTACLE DATA SET

When the obstacle data set is provided, the following sections of the AIP may be left blank and a reference to the data set availability should be provided:

- (a) ENR 5.4 Air navigation obstacles;
- (b) AD 2.10 Aerodrome obstacles; and
- (c) AD 3.10 Heliport obstacles.

GM5 AIS.TR.305(c) Aeronautical information publication (AIP)

ED Decision 2022/015/R

INFORMATION PUBLISHED REGARDING USE OF MATERIAL FOR MOVEMENT AREA SURFACE TREATMENT UNDER 'AD 2.7 RUNWAY SURFACE CONDITION ASSESSMENT AND REPORTING AND SNOW PLAN'

The following list contains the abbreviations/words that may be published in the relevant section of the AIP regarding the use of material for movement area surface treatment, according to the information originated by the aerodrome operator:

- (a) KAC, for potassium acetate fluids;
- (b) KFOR, for potassium formate fluids;
- (c) GAC, for glycerine acetate fluids;
- (d) NAFO, for sodium formate solids;
- (e) NAAC, for sodium acetate solids;
- (f) EG, for ethylene glycol fluids;
- (g) PG, for propylene glycol fluids;
- (h) UREA; and
- (i) SAND.

GM6 AIS.TR.305(c) Aeronautical information publication (AIP)

ED Decision 2022/015/R

INFORMATION FOR LED LIGHTS PUBLISHED UNDER 'AD 2.14 APPROACH AND RUNWAY LIGHTING'

Examples of information published in the 'Remarks' indicating that light emitting diode (LED) lights are used as part of the approach and runway lighting system of the aerodrome, are shown below:

- 'RWY 05, LED and incandescent lights used as part of the RWY edge lights on both sides of RWY';
- 'RWY 05, LED lights used for the centreline lighting system in the first 600 m; remaining length incandescent lights are used';
- 'RWY 05, LED lights used in the full length of the approach lighting system'.

GM7 AIS.TR.305(c) Aeronautical information publication (AIP)

ED Decision 2022/015/R

INFORMATION FOR VISUAL SEGMENT SURFACE (VSS) PENETRATION, PUBLISHED UNDER 'AD 2.25'

In case of VSS penetration, the information published under AD 2.25 is limited to the name of the affected procedure and procedure minima affected; information about the obstacles themselves penetrating the VSS is not published under 'AD 2.25', as such information is meant to be published under 'AD 2.10 Aerodrome obstacles'.

AIS.TR.310 AIP amendments

Commission Implementing Regulation (EU) 2020/469

- (a) Any operationally significant changes to the AIP, in accordance with point [AIS.OR.505](#), shall be issued under AIRAC and clearly identified as such.
- (b) Each AIP amendment shall be allocated a serial number, which shall be consecutive.
- (c) When an AIP amendment is issued, it shall include references to the serial number of the NOTAM which have been incorporated into the amendment.
- (d) The most current update cycles applicable to AIP amendments shall be made publicly available.
- (e) Recourse to hand amendments/annotations shall be kept to a minimum; the normal method of amendment shall be by reissuing or by replacement of pages.
- (f) Each AIP amendment shall:
 - (1) include a checklist with the current dates and numbers of each loose-leaf page in the AIP; and
 - (2) provide a recapitulation of any outstanding hand amendments.
- (g) New or revised information shall be identified by an annotation against it in the margin.
- (h) Each AIP amendment page, including the cover sheet, shall contain a publication date and, when applicable, an effective date.
- (i) The regular intervals between the AIP amendments shall be specified in Part 1 – General (GEN) of the AIP.

AMC1 AIS.TR.310(g) AIP amendments

ED Decision 2020/008/R

ANNOTATION

- (a) The annotation in the margin should be done by a thick black vertical line or, where the change incorporated covers one line only or a part of a line, a thick black horizontal arrow.
- (b) For aeronautical charts, the annotation should be made as a marginal note.

GM1 AIS.TR.310(h) AIP amendments

ED Decision 2020/008/R

EFFECTIVE TIME

When an effective time other than 00.00 UTC is used, the effective time should also be indicated.

AIS.TR.315 AIP supplements

Commission Implementing Regulation (EU) 2020/469

- (a) The AIP supplement issued in printed form shall be provided by means of distinctive pages.
- (b) The most current update cycles applicable to AIP supplements shall be made publicly available.
- (c) Each AIP supplement shall be allocated a serial number which shall be consecutive and based on the calendar year.
- (d) Whenever an AIP supplement is issued as a replacement of a NOTAM, a reference to the series and number of the NOTAM shall be included.
- (e) A checklist of valid AIP supplements shall be issued at intervals of not more than one month, as part of the checklist of NOTAM and also with distribution as for the AIP supplements.
- (f) Each AIP supplement page shall have a publication date. Each AIRAC AIP supplement page shall have both a publication and an effective date.

GM1 AIS.TR.315 AIP supplements

ED Decision 2020/008/R

ISSUE OF NOTAM

When there is not sufficient time for the distribution of an AIP supplement, a NOTAM may be issued.

AIS.TR.320 Aeronautical information circular (AIC)

Commission Implementing Regulation (EU) 2020/469

- (a) The AIC shall be provided as an electronic document.
- (b) The AIC shall be provided whenever it is desirable to promulgate:
 - (1) forecasts of important changes in the air navigation procedures, services and facilities;
 - (2) forecasts of implementation of new navigational systems;
 - (3) significant information derived from aircraft accident/incident investigation which has a bearing on flight safety;
 - (4) information on regulations related to the safeguarding of civil aviation against acts of unlawful interference that jeopardise the security of civil aviation;
 - (5) advice on medical matters of special interest to pilots;
 - (6) warnings to pilots concerning the avoidance of physical hazards;
 - (7) information on the effect of certain weather phenomena on aircraft operations;
 - (8) information on new hazards affecting aircraft handling techniques;
 - (9) information on regulations related to the carriage of restricted articles by air;
 - (10) references to the requirements of national and EU legislation and to the publication of changes therein;
 - (11) information on aircrew licensing arrangements;
 - (12) information on training of aviation personnel;

- (13) information on the implementation of, or exemption from, requirements in national and EU legislation;
 - (14) advice on the use and maintenance of specific types of equipment;
 - (15) the actual or planned availability of new or revised editions of aeronautical charts;
 - (16) information on the carriage of communication equipment;
 - (17) explanatory information related to noise abatement;
 - (18) selected airworthiness directives;
 - (19) information on changes in NOTAM series or distribution, new editions of AIP or major changes in their content, coverage or format;
 - (20) advance information on the snow plan; and
 - (21) other information of a similar nature.
- (c) The AIC shall not be used for information that qualifies for inclusion in AIP or NOTAM.
 - (d) The snow plan issued in accordance with point AD 1.2.2 of the AIP shall be supplemented by seasonal information to be issued as an AIC well in advance of the beginning of each winter – not less than one month before the normal onset of winter conditions.
 - (e) When the AIC is selected by the originating Member State for distribution beyond its territory, it shall have the same distribution as the AIP.
 - (f) Each AIC shall be allocated a serial number which shall be consecutive and based on the calendar year.
 - (g) In the event that an AIC is provided in more than one series, each series shall be separately identified by a letter.
 - (h) A checklist of AIC currently in force shall be issued at least once a year, with distribution as for the AIC.
 - (i) A checklist of AIC provided beyond the territory of a Member State shall be included in the NOTAM checklist.

AMC1 AIS.TR.320(a) Aeronautical information circular (AIC)

ED Decision 2020/008/R

ELECTRONIC FORM

When AICs are provided as part of the 'electronic AIP', they should comply with the EUROCONTROL 'Specification for the Electronic Aeronautical Information Publication (eAIP)' (edition 2.1, dated 6 October 2015).

GM1 AIS.TR.320(a) Aeronautical information circular (AIC)

ED Decision 2020/008/R

PRINTED FORM

Differentiation and identification of AIC topics according to subjects using colour coding should be practised where the numbers of AICs in force are sufficient to make identification in this form necessary. For example:

- (a) white — administrative;
- (b) yellow — ATC;
- (c) pink — safety;
- (d) mauve — danger area map; and
- (e) green — maps/charts.

GM1 AIS.TR.320(c) Aeronautical information circular (AIC)

ED Decision 2020/008/R

GENERAL

- (a) AICs are not used to promulgate aeronautical data and aeronautical information that qualify for inclusion in AIP (including amendments and supplements) or in NOTAM. Nevertheless, AICs can be used to provide detailed information and/or interpretation about data contained in those aeronautical information products.
- (b) Consequently:
 - (1) an AIC is not used to promulgate aeronautical data that is part of the data catalogue; and
 - (2) the content of an AIC is not subject to the application of the DQRs.
- (c) AICs can be made available with the electronic AIP for distribution purpose, as long as it is understood that they remain separate aeronautical information products.

GM1 AIS.TR.320(d) Aeronautical information circular (AIC)

ED Decision 2020/008/R

SNOW PLAN INFORMATION

The seasonal AIC on the snow plan may contain information such as that listed below:

- (a) a list of aerodromes/heliports where during the coming winter the following are expected to be performed:
 - (1) snow clearance in accordance with the runway and taxiway systems; or
 - (2) planned snow clearing, deviating from the runway system (length, width and number of runways, affected taxiways and aprons or portions thereof);
- (b) information concerning any centre designated to coordinate information on the current state of progress of clearance and on the current state of runways, taxiways and aprons;
- (c) a division of the aerodromes/heliports into SNOWTAM distribution lists in order to avoid excessive NOTAM distribution;
- (d) an indication, as necessary, of minor changes to the standing snow plan;
- (e) a descriptive list of clearance equipment; and
- (f) a listing of what will be considered as the minimum critical snow bank to be reported at each aerodrome/heliport at which reporting will commence.

AIS.TR.330 NOTAM

Regulation (EU) 2020/469

- (a) A NOTAM shall be issued when it is necessary to provide the following information:
- (1) establishment of, closure of, or significant changes in the operation of aerodromes or heliports or runways;
 - (2) establishment of, withdrawal of, and significant changes in, the operation of aeronautical services;
 - (3) establishment of, withdrawal of, and significant changes in, the operational capability of radio navigation and air-ground communication services;
 - (4) unavailability of backup and secondary systems, having a direct operational impact;
 - (5) establishment of, withdrawal of, or significant changes to, visual aids;
 - (6) interruption of, or return to operation of, major components of aerodrome lighting systems;
 - (7) establishment of, withdrawal of, or significant changes to, procedures for air navigation services;
 - (8) occurrence or correction of major defects or impediments in the manoeuvring area;
 - (9) changes to, and limitations on, the availability of fuel, oil and oxygen;
 - (10) major changes to search and rescue (SAR) facilities and services available;
 - (11) establishment of, withdrawal of, or return to, operation of hazard beacons marking obstacles to air navigation;
 - (12) changes in regulations applicable in the Member State(s) concerned that require immediate action from an operational perspective;
 - (13) operational directives requiring immediate action or changes thereto;
 - (14) presence of hazards that affect air navigation;
 - (15) planned laser emissions, laser displays and search lights if pilots' night vision is likely to be impaired;
 - (16) erecting or removal of, or changes to, obstacles to air navigation in the take-off/climb, missed approach, approach areas as well as on the runway strip;
 - (17) establishment or discontinuance of, including activation or deactivation, as applicable, or changes in, the status of prohibited, restricted or danger areas;
 - (18) establishment or discontinuance of areas or routes, or portions thereof, where the possibility of interception exists and where the maintenance of guard on the very high frequency (VHF) emergency frequency 121.500 MHz is required;
 - (19) allocation, cancellation or change of location indicators;
 - (20) changes in aerodrome/heliport rescue and firefighting (RFF) category;
 - (21) presence of, removal of, or significant changes in, hazardous conditions due to snow, slush, ice, radioactive material, toxic chemicals, volcanic ash deposition or water on the movement area;

-
- (22) outbreaks of epidemics necessitating changes in notified requirements for inoculations and quarantine measures;
 - (23) forecasts of solar cosmic radiation, where provided;
 - (24) an operationally significant change in volcanic activity, the location, date and time of volcanic eruptions and/or the horizontal and vertical extent of a volcanic ash cloud, including direction of movement, flight levels and routes or portions of routes that could be affected;
 - (25) (release into the atmosphere of radioactive materials or toxic chemicals following a nuclear or chemical incident, the location, date and time of the incident, the flight levels and routes, or portions thereof, that could be affected, as well as the direction of movement;
 - (26) establishment of operations of humanitarian relief missions, together with procedures and/or limitations that affect air navigation;
 - (27) implementation of short-term contingency measures in cases of disruption, or partial disruption, of ATS and related supporting services;
 - (28) specific loss of integrity of satellite-based navigation systems.
 - (29) unavailability of a runway due to runway marking works or, if the equipment used for those works can be removed, a time lag required for making the runway available.'
- (b) A NOTAM shall not be issued to provide any of the following information:
- (1) routine maintenance work on aprons and taxiways that does not affect the safe movement of aircraft;
 - (2) temporary obstructions in the vicinity of aerodromes/heliports that do not affect the safe operation of aircraft;
 - (3) partial failure of aerodrome/heliport lighting facilities where such failure does not directly affect aircraft operations;
 - (4) partial temporary failure of air-ground communications when suitable alternative frequencies are available and are operative;
 - (5) lack of apron marshalling services, road traffic closures, limitations and control;
 - (6) the unserviceability of location, destination or other instruction signs on the aerodrome movement area;
 - (7) parachuting when in uncontrolled airspace under visual flight rules (VFR), or when in controlled airspace at promulgated sites or within danger or prohibited areas;
 - (8) training activities performed by ground units;
 - (9) unavailability of backup and secondary systems if these do not have an operational impact;
 - (10) limitations to airport facilities or general services, with no operational impact;
 - (11) national regulations not affecting general aviation;
 - (12) announcements or warnings about possible/potential limitations, with no operational impact;
 - (13) general reminders on already published information;

- (14) availability of equipment for ground units, without information on the operational impact on airspace and facility users;
 - (15) information about laser emissions with no operational impact and about fireworks below the minimum flying heights;
 - (16) closure of parts of the movement area in connection with locally coordinated, planned work of duration of less than one hour;
 - (17) closure, changes, unavailability in the operation of aerodrome(s)/heliport(s) other than in the aerodrome(s)/ heliport(s) operation hours; and
 - (18) other non-operational information of a similar temporary nature.
- (c) Except as provided for in points AIS.TR.330(f) and AIS.TR.330(g), each NOTAM shall contain the information in the order shown in the NOTAM format of Appendix 2.
 - (d) NOTAM text shall be composed of the significations/uniform abbreviated phraseology assigned to the ICAO NOTAM Code, complemented by ICAO abbreviations, indicators, identifiers, designators, call signs, frequencies, figures and plain language.
 - (e) All NOTAM shall be issued in English language. If necessary for domestic users, NOTAM may additionally be issued in national language.
 - (f) Information concerning snow, slush, ice, frost, standing water or water associated with snow, slush, ice or frost on the movement area shall be disseminated by means of SNOWTAM and shall contain the information in the order shown in the SNOWTAM format of Appendix 3a.
 - (g) Information concerning an operationally significant change to volcanic activity, volcanic eruption and/or volcanic ash cloud shall, when reported by means of an ASHTAM, contain the information in the order shown in the ASHTAM format of Appendix 4.
 - (h) When errors occur in a NOTAM, a NOTAM with a new number shall be issued to replace the erroneous NOTAM or the erroneous NOTAM shall be cancelled and a new NOTAM shall be issued.
 - (i) When a NOTAM is issued that cancels or replaces a previous NOTAM:
 - (1) the series and number/year of the previous NOTAM shall be indicated;
 - (2) the series, location indicator and subject of both NOTAM shall be the same.
 - (j) Only one NOTAM shall be cancelled or replaced by a NOTAM.
 - (k) Each NOTAM shall deal with only one subject and one condition of the subject.
 - (l) Each NOTAM shall be as brief as possible and compiled so that its meaning is clear without the need to refer to another document.
 - (m) A NOTAM containing permanent or temporary information of long duration shall include appropriate references to the AIP or AIP supplement.
 - (n) Location indicators included in the text of a NOTAM shall be those contained in ICAO Doc 7910 'Location Indicators'. A curtailed form of such indicators shall not be used. Where no ICAO location indicator is assigned to the location, its place name shall be entered in plain language.
 - (o) A series identified by a letter and a four-digit number followed by a stroke and a two-digit number for the year shall be allocated to each NOTAM. The four-digit number shall be consecutive and based on the calendar year.

- (p) All NOTAM shall be divided in series based on subject, traffic or location or a combination thereof, depending on end-user needs. NOTAM for aerodromes allowing international air traffic shall be issued in international NOTAM series.
- (q) If NOTAM are issued in both English and national language, the NOTAM series shall be organised so that the national language series are equivalent to the English language series in terms of content and numbering.
- (r) The content and geographical coverage of each NOTAM series shall be stated in detail in the AIP, in point GEN 3.
- (s) A checklist of valid NOTAM shall be regularly provided.
- (t) One checklist NOTAM shall be issued for each series.
- (u) A checklist NOTAM shall also refer to the latest AIP amendments, AIP supplements, data sets and, at least, to distributed AIC.
- (v) A checklist NOTAM shall have the same distribution as the actual message series to which it refers and shall be clearly identified as a checklist.
- (w) Series allocation shall be monitored and, if required, appropriate measures shall be taken to assure that no series reaches the maximum possible number of issued NOTAM before the end of a calendar year.

AMC1 AIS.TR.330 NOTAM

ED Decision 2020/008/R

USE OF OPADD

The origination and issuing of NOTAM should be in accordance with the EUROCONTROL ‘Guidelines — Operating Procedures for AIS Dynamic Data (OPADD)’ (edition 4.0, dated 17 April 2015).

GM1 AIS.TR.330(d) NOTAM

ED Decision 2020/008/R

NOTAM CODE

The ICAO NOTAM Code together with significations/uniform abbreviated phraseology, and ICAO Abbreviations are those contained in ICAO Doc 8400 ‘Procedures for Air Navigation Services — ICAO Abbreviations and Codes (PANS-ABC)’.

GM1 AIS.TR.330(u) NOTAM

ED Decision 2020/008/R

CHECKLIST

The checklist NOTAM may include the checklist of AIP Supplement (SUP).

CHAPTER 2 — DIGITAL DATA SETS

AIS.TR.335 General — Digital data sets

Commission Implementing Regulation (EU) 2020/469

- (a) A standard for geographic information shall be used as a reference framework.
- (b) A description of each available data set shall be provided in the form of a data product specification.
- (c) A checklist of the available data sets, including their effective and publication dates, shall be made available to users to ensure that current data is being used.
- (d) The checklist of data sets shall be made available through the same distribution mechanism as the one used for the data sets.

GM1 AIS.TR.335(a) General — Digital data sets

ED Decision 2020/008/R

STANDARD FOR GEOGRAPHIC INFORMATION

The ISO 19100 series of standards for geographic information may be used as a reference framework.

GM1 AIS.TR.335(b) General — Digital data sets

ED Decision 2020/008/R

DATA PRODUCT SPECIFICATION

- (a) ISO Standard 19131 specifies the requirements and outline of data product specifications for geographic information. This is intended to facilitate and support the use and exchange of digital data sets between data providers and data users.
- (b) The data product specification enables air navigation users to evaluate the products and determine whether they fulfil the requirements for their intended use (application).
- (c) This may include an overview, specification scope, data product identification, data content and structure, reference system, data quality, data capture, data maintenance, data portrayal, data product delivery, additional information, and metadata.

AIS.TR.340 Metadata requirements

Commission Implementing Regulation (EU) 2020/469

The minimum metadata for each data set shall include:

- (a) the name of the organisations or entities providing the data set;
- (b) the date and time when the data set was provided;
- (c) the validity of the data set; and
- (d) any limitations on the use of the data set.

AIS.TR.345 AIP data set

Commission Implementing Regulation (EU) 2020/469

- (a) The AIP data set shall include data about the following subjects, including the properties indicated, if applicable:

Data subjects	Associated properties as a minimum
ATS airspace	Type, name, lateral limits, vertical limits, class of airspace
Special activity airspace	Type, name, lateral limits, vertical limits, restriction, activation
Route	Identifier prefix, flight rules, designator
Route segment	Navigation specification, start point, end point, track, distance, upper limit, lower limit, minimum en-route altitude (MEA), minimum obstacle clearance altitude (MOCA), direction of cruising level, reverse direction of cruising level, required navigation performance
Waypoint – en-route	Reporting requirement, identification, location, formation
Aerodrome/heliport	Location indicator, name, International Air Transport Association (IATA) designator, served city, certification date, certification expiration date, if applicable, control type, field elevation, reference temperature, magnetic variation, airport reference point
Runway	Designator, nominal length, nominal width, surface type, strength
Runway direction	Designator, true bearing, threshold, take-off run available (TORA), take-off distance available (TODA), accelerate-stop distance available (ASDA), landing distance available (LDA), rejected TODA (for helicopters)
Final approach and take-off area (FATO)	Designation, length, width, threshold point
Touchdown and lift-off area (TLOF)	Designator, centre point, length, width, surface type
Radio navigation aid	Type identification, name, aerodrome served, hours of operation, magnetic variation, frequency/channel, position, elevation, magnetic bearing, true bearing, zero bearing direction

- (b) When a property is not defined for a particular occurrence of the subjects listed in (a), the AIP data subset shall include an explicit indication: ‘not applicable’.

GM1 AIS.TR.345(b) AIP data set

ED Decision 2020/008/R

PROPERTY

There may also be other reasons why a property is not provided, e.g. missing, unknown, withheld, etc.

AIS.TR.350 Terrain and obstacle data – General requirements

Commission Implementing Regulation (EU) 2020/469

The coverage areas for sets of terrain and obstacle data shall be specified as:

- (a) Area 1: the entire territory of a Member State;
- (b) Area 2: within the vicinity of an aerodrome, subdivided as follows:
 - (1) Area 2a: a rectangular area around a runway which comprises the runway strip plus any clearway that exists;
 - (2) Area 2b: an area extending from the ends of Area 2a in the direction of departure, with a length of 10 km and a splay of 15 % to each side;
 - (3) Area 2c: an area extending outside Areas 2a and 2b at a distance of not more than 10 km from the boundary of Area 2a; and
 - (4) Area 2d: an area outside Areas 2a, 2b and 2c up to a distance of 45 km from the aerodrome reference point, or to an existing terminal manoeuvring area (TMA) boundary, whichever is nearer;
- (c) Area 3: the area bordering an aerodrome movement area which extends horizontally from the edge of a runway to 90 m from the runway centre line and 50 m from the edge of all other parts of the aerodrome movement area; and
- (d) Area 4: the area extending 900 m prior to the runway threshold and 60 m to each side of the extended runway centre line in the direction of the approach on a precision approach runway, Category II or III.

GM1 AIS.TR.350(d) Terrain and obstacle data — General requirements

ED Decision 2020/008/R

AREA 4

Where the terrain at a distance greater than 900 m (3 000 ft) from the runway threshold is mountainous or otherwise significant, the length of Area 4 should be extended to a distance not exceeding 2 000 m (6 500 ft) from the runway threshold.

AIS.TR.355 Terrain data sets

Commission Implementing Regulation (EU) 2020/469

When terrain data sets are provided in accordance with point [AIS.OR.355](#):

- (a) terrain data sets shall contain the digital representation of the terrain surface in the form of continuous elevation values at all intersections of a defined grid, referenced to a common datum;
- (b) a terrain grid shall be angular or linear and shall be of a regular or irregular shape;
- (c) terrain data sets shall include spatial (position and elevation), thematic, and temporal aspects of the surface of the Earth, containing naturally occurring features, excluding obstacles;
- (d) only one feature type, i.e. terrain, shall be provided;
- (e) the following terrain feature attributes shall be recorded in the terrain data set:
 - (1) area of coverage;
 - (2) identification of the data originator er;
 - (3) data source identifier;
 - (4) acquisition method;
 - (5) post spacing;
 - (6) horizontal reference system;
 - (7) horizontal resolution;
 - (8) horizontal accuracy;
 - (9) horizontal confidence level;
 - (10) horizontal position;
 - (11) elevation;
 - (12) elevation reference;
 - (13) vertical reference system;
 - (14) vertical resolution;
 - (15) vertical accuracy;
 - (16) vertical confidence level;
 - (17) recorded surface;
 - (18) integrity;
 - (19) date and time stamp; and
 - (20) unit of measurement used;
- (f) Within the area covered by a 10-km radius from the ARP, terrain data shall comply with the Area 2 numerical requirements;
- (g) in the area between 10 km and the TMA boundary or a 45-km radius, whichever is smaller, data on terrain that penetrates the horizontal plane 120 m above the lowest runway elevation shall comply with the Area-2 numerical requirements;

- (h) in the area between 10 km and the TMA boundary or a 45-km radius, whichever is smaller, data on terrain that does not penetrate the horizontal plane 120 m above the lowest runway elevation shall comply with the Area-1 numerical requirements; and
- (i) in those portions of Area 2 where flight operations are prohibited due to very high terrain or other local restrictions and/or regulations, terrain data shall comply with the Area-1 numerical requirements.

Terrain data collection surfaces – Area 1 and Area 2

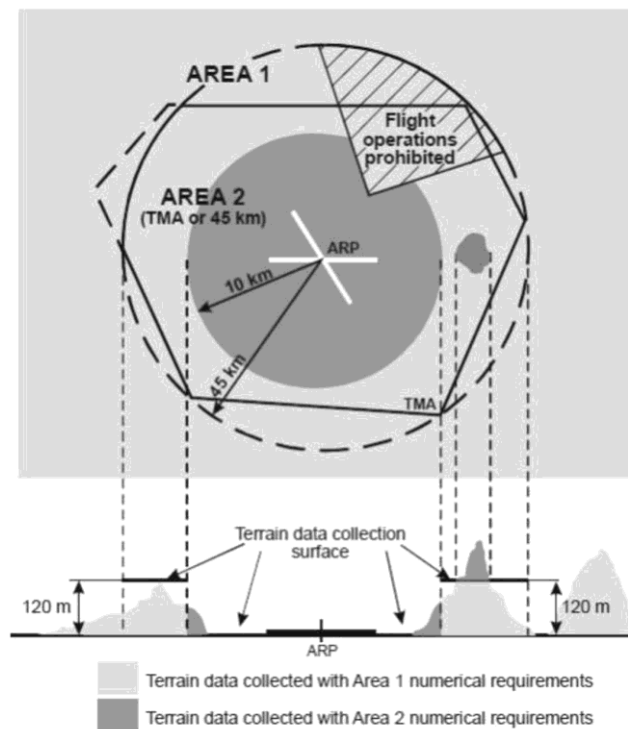

GM1 AIS.TR.355(e) Terrain data sets

ED Decision 2020/008/R

ATTRIBUTES

The following additional terrain feature attributes may be recorded in the terrain data set:

- (a) surface type;
- (b) penetration level; and
- (c) known variations.

AIS.TR.360 Obstacle data sets

Commission Implementing Regulation (EU) 2020/469

When obstacle data sets are provided in accordance with point [AIS.OR.360](#):

- (a) obstacle data items are features that shall be represented in the data sets by points, lines or polygons;
- (b) all defined obstacle feature types shall be provided and each of them shall be described according to the following list of attributes:
 - (1) area of coverage;
 - (2) identification of the data originator;
 - (3) data source identifier;
 - (4) obstacle identifier;
 - (5) horizontal accuracy;
 - (6) horizontal confidence level;
 - (7) horizontal position;
 - (8) horizontal resolution;
 - (9) horizontal extent;
 - (10) horizontal reference system;
 - (11) elevation;
 - (12) vertical accuracy;
 - (13) vertical confidence level;
 - (14) vertical resolution;
 - (15) vertical reference system;
 - (16) obstacle type;
 - (17) geometry type;
 - (18) integrity;
 - (19) date and time stamp;
 - (20) unit of measurement used;
 - (21) lighting; and
 - (22) marking;
- (c) obstacle data for Areas 2 and 3 shall be collected in accordance with the following obstacle collection surfaces:
 - (1) the Area 2a obstacle collection surface has a height of 3 m above the nearest runway elevation measured along the runway centre line, and for those portions related to a clearway, if one exists, at the elevation of the nearest runway end;
 - (2) the Area 2b obstacle collection surface has a 1,2 % slope extending from the ends of Area 2a at the elevation of the runway end in the direction of departure, with a length of 10

- km and a splay of 15 % to each side; obstacles less than 3 m in height above the ground need not be collected;
- (3) the Area 2c obstacle collection surface has a 1,2 % slope extending outside Areas 2a and 2b at a distance of not more than 10 km from the boundary of Area 2a; the initial elevation of Area 2c shall be the elevation of the point of Area 2a at which it commences; obstacles less than 15 m in height above the ground need not be collected;
 - (4) the Area 2d obstacle collection surface has a height of 100 m above the ground; and
 - (5) the Area 3 obstacle collection surface extends 0.5 m above the horizontal plane passing through the nearest point on the aerodrome movement area;
- (d) in those portions of Area 2 where flight operations are prohibited due to very high terrain or other local restrictions and/or regulations, obstacle data shall be collected and recorded in accordance with the Area 1 numerical requirements;
 - (e) the obstacle data product specification, supported by geographical coordinates for each aerodrome included within the dataset, shall describe the following areas:
 - (1) Areas 2a, 2b, 2c and 2d;
 - (2) the take-off flight path area; and
 - (3) the obstacle limitation surfaces;
 - (f) obstacle data sets shall contain the digital representation of the vertical and horizontal extent of the obstacles; and
 - (g) obstacles shall not be included in terrain data sets.

Obstacle data collection surfaces – Area 1 and Area 2

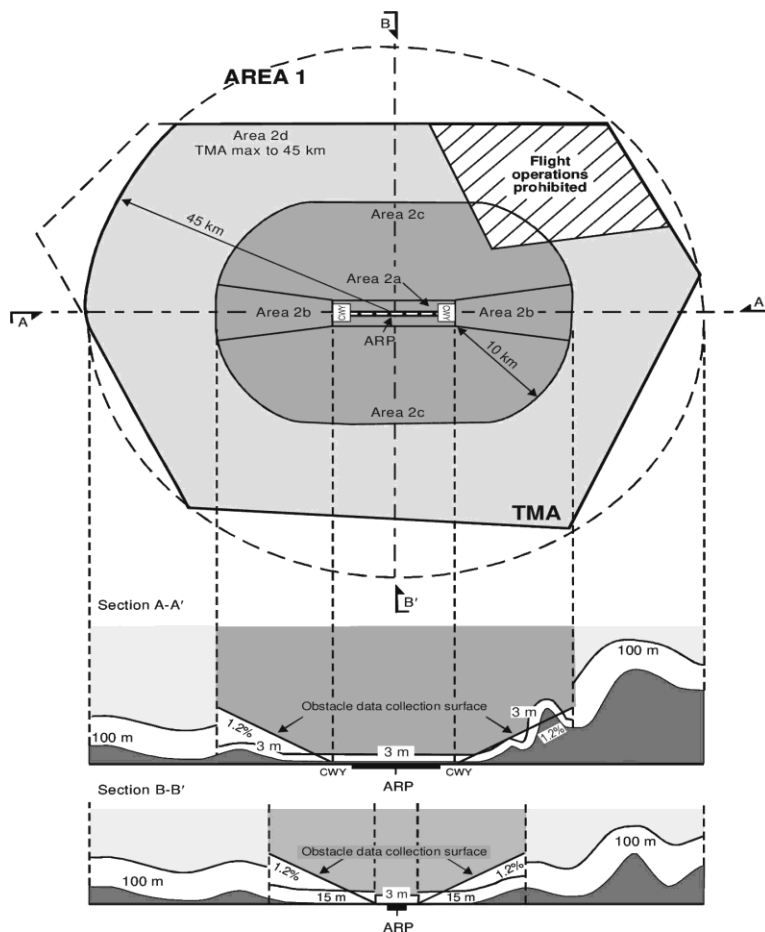

GM1 AIS.TR.360(b) Obstacle data sets

ED Decision 2020/008/R

ATTRIBUTES

The following additional obstacle feature attributes may be recorded in the obstacle data set:

- (a) height;
- (b) operations; and
- (c) effectiveness.

AIS.TR.365 Aerodrome mapping data sets

Commission Implementing Regulation (EU) 2020/469

- (a) Aerodrome mapping data sets shall contain the digital representation of aerodrome features.
- (b) ISO standards for geographic information shall be used as a reference framework.
- (c) Aerodrome mapping data products shall be described following the relevant data product specification standard.
- (d) The content and structure of aerodrome mapping data sets shall be defined in terms of an application schema and a feature catalogue

GM1 AIS.TR.365 Aerodrome mapping data sets

ED Decision 2020/008/R

ADDITIONAL GUIDANCE

Further information concerning minimum requirements and reference material applicable to the content, origination, publication, and updating of aerodrome mapping information may be found in EUROCAE ED-99D 'User Requirement for Aerodrome Mapping Information', October 2015, and EUROCAE ED-119C 'Interchange Standards for Terrain, Obstacle and Aerodrome Mapping Data', October 2015.

GM1 AIS.TR.365(a) Aerodrome mapping data sets

ED Decision 2020/008/R

AERODROME FEATURES

Aerodrome features consist of attributes and geometries, which are characterised as points, lines or polygons. Examples include runway thresholds, taxiway guidance lines and parking stand areas.

GM2 AIS.TR.365(a) Aerodrome mapping data sets

ED Decision 2020/008/R

ADDITIONAL DATA

Aerodrome mapping data may be supported by electronic terrain and obstacle data for Area 3 in order to ensure consistency and quality of all geographical data related to the aerodrome.

GM3 AIS.TR.365(a) Aerodrome mapping data sets

ED Decision 2020/008/R

COMMON ACQUISITION TECHNIQUES

Electronic terrain and obstacle data pertaining to Area 3 as well as aerodrome mapping data may be originated using common acquisition techniques and managed within a single geographic information system (GIS).

GM1 AIS.TR.365(b) Aerodrome mapping data sets

ED Decision 2020/008/R

GENERAL

ISO Standard 19100 series on geographic information can be used as a reference framework.

GM1 AIS.TR.365(c) Aerodrome mapping data sets

ED Decision 2020/008/R

GENERAL

ISO Standard 19131 contains standards for data product specification.

GM1 AIS.TR.365(d) Aerodrome mapping data sets

ED Decision 2020/008/R

GENERAL

ISO Standard 19109 contains standards for application schemas, while ISO Standard 19110 describes the feature cataloguing methodology for geographic information.

AIS.TR.370 Instrument flight procedure data sets

Commission Implementing Regulation (EU) 2020/469

- (a) Instrument flight procedure data sets shall contain the digital representation of instrument flight procedures.
- (b) The instrument flight procedure data sets shall include data about the following subjects, including all of their properties:
 - (1) procedure;
 - (2) procedure segment;
 - (3) final approach segment;
 - (4) procedure fix;
 - (5) procedure holding;
 - (6) helicopter procedure specifics.

GM1 AIS.TR.370 Instrument flight procedure data sets

ED Decision 2020/008/R

GENERAL

Guidance on the instrument flight procedure data sets can be found in PANS-OPS, ICAO Doc 8168, Volume II – Part III, Section 2, Chapter 5.

SECTION 4 - DISTRIBUTION SERVICES

AIS.TR.400 Distribution services

Commission Implementing Regulation (EU) 2020/469

- (a) A predetermined distribution system for NOTAM transmitted on the AFS shall be used whenever possible.
- (b) Distribution of NOTAM series other than those distributed internationally shall be granted upon request.
- (c) NOTAM shall be prepared in conformity with ICAO communication procedures laid down in ICAO Annex 10, Volume II.
- (d) Each NOTAM shall be transmitted as a single telecommunication message.
- (e) The exchange of ASHTAM beyond the territory of a Member State, and NOTAM where Member States use NOTAM for distribution of information on volcanic activity, shall include volcanic ash advisory centres and the world area forecast centres, and take account of the requirements of long-range operations.

GM1 AIS.TR.400(a) Distribution services

ED Decision 2020/008/R

NOTAM

- (a) The predetermined distribution system provides for incoming NOTAM (including SNOWTAM and ASHTAM) to be channelled through the aeronautical fixed service (AFS) directly to designated addressees predetermined by the receiving country concerned while concurrently being routed to the international NOTAM office for checking and control purposes.
- (b) The addressee indicators for those designated addressees are constituted as follows:
 - (1) First and second letters
The first two letters of the location indicator for the AFS communication centre associated with the relevant international NOTAM office of the receiving country.
 - (2) Third and fourth letters
The letters 'ZZ' indicating a requirement for special distribution.
 - (3) Fifth letter
The fifth letter differentiating between NOTAM (letter 'N'), SNOWTAM (letter 'S'), and ASHTAM (letter 'V').
 - (4) Sixth and seventh letters
The sixth and seventh letters, each taken from the series A to Z, denoting the national and/or international distribution list(s) to be used by the receiving AFS centre.
The fifth, sixth and seventh letters replace the three-letter designator YNY which, in the normal distribution system, denotes an international NOTAM office.

(5) Eighth letter

The eighth position letter shall be the filler letter 'X' to complete the eight-letter addressee indicator.

- (c) Member States are to inform the States from which they receive NOTAM of the sixth and seventh letters to be used under different circumstances to ensure proper routing.

AIS.TR.405 Pre-flight information services

Commission Implementing Regulation (EU) 2020/469

- (a) Automated pre-flight information systems shall be used to make aeronautical data and aeronautical information available to operations personnel, including flight crew members, for self-briefing, flight planning and flight information service purposes.
- (b) The human machine interface of the pre-flight information services facilities shall ensure easy access to all relevant information/data in a guided manner.
- (c) Self-briefing facilities of an automated pre-flight information system shall provide access, as necessary, to the aeronautical information service for consultation by telephone or other suitable telecommunication means.
- (d) Automated pre-flight information systems for the supply of aeronautical data and aeronautical information for self-briefing, flight planning and flight information service shall:
- (1) provide for continuous and timely updating of the system database and monitoring of the validity and quality of the aeronautical data stored;
 - (2) permit access to the system by operations personnel, including flight crew members, aeronautical personnel concerned and other aeronautical users, through suitable telecommunications means;
 - (3) ensure the provision of the aeronautical data and aeronautical information accessed, in paper form, as required;
 - (4) use access and interrogation procedures based on abbreviated plain language and ICAO location indicators laid down in ICAO Doc 7910, as appropriate, or based on a menu-driven user interface or other appropriate mechanism;
 - (5) provide a timely response to a user request for information.
- (e) All NOTAM shall be made available for briefing by default, and content reduction shall be at user's discretion.

GM1 AIS.TR.405(a) Pre-flight information services

ED Decision 2020/008/R

AUTOMATION

- (a) Automated pre-flight information systems that provide a harmonised, common point of access by operations personnel, including flight crew members and other aeronautical personnel concerned, to aeronautical information and meteorological information should be established by an agreement between the AIS provider and the meteorological services provider.
- (b) Where automated pre-flight information systems are used to provide the harmonised, common point of access by operations personnel, including flight crew members and other aeronautical personnel concerned, to aeronautical data, aeronautical information and meteorological

information, the AIS provider remains responsible for the quality and timeliness of the aeronautical data and aeronautical information provided by means of such a system.

- (c) The meteorological services provider concerned remains responsible for the quality of the meteorological information provided by means of such a system in accordance with Annex V to Regulation (EU) 2017/373.

GM1 AIS.TR.405(e) Pre-flight information services

ED Decision 2020/008/R

NOTAM

Although NOTAM with purpose 'M' are regarded not subject for a briefing but available on request, all NOTAM are to be provided for briefing by default, and content reduction should be at user's discretion.

SECTION 5 - AERONAUTICAL INFORMATION PRODUCTS UPDATES

AIS.TR.500 General – Aeronautical information products updates

Commission Implementing Regulation (EU) 2020/469

The same AIRAC cycle update shall be applied to the AIP amendments, AIP supplements, AIP data set and the instrument flight procedure data sets in order to ensure consistency of the data items that appear in multiple aeronautical information products.

AIS.TR.505 AIRAC

Commission Implementing Regulation (EU) 2020/469

- (a) Information concerning the following circumstances shall be distributed under the AIRAC system:
- (1) horizontal and vertical limits, regulations and procedures applicable to:
 - (i) flight information regions (FIRs);
 - (ii) control areas (CTAs);
 - (iii) control zones;
 - (iv) advisory areas;
 - (v) ATS routes;
 - (vi) permanent danger, prohibited and restricted areas (including type and periods of activity, when known) and air defence identification zones (ADIZs);
 - (vii) permanent areas or routes, or portions thereof, where the possibility of interception exists;
 - (viii) RMZ and/or TMZ;
 - (2) positions, frequencies, call signs, identifiers, known irregularities and maintenance periods of radio navigation aids, and communication and surveillance facilities;
 - (3) holding and approach procedures, arrival and departure procedures, noise abatement procedures and any other pertinent ATS procedures;
 - (4) transition levels, transition altitudes and minimum sector altitudes;
 - (5) meteorological facilities (including broadcasts) and procedures;
 - (6) runways and stopways;
 - (7) taxiways and aprons;
 - (8) aerodrome ground operating procedures (including low-visibility procedures);
 - (9) approach and runway lighting; and
 - (10) aerodrome operating minima, if published by a Member State.
- (b) Special arrangements shall be made whenever major changes are planned and where advance notice is desirable and practicable.

- (c) When information has not been submitted by the AIRAC date, a NIL notification shall be distributed through a NOTAM or other suitable means, not later than one cycle before the AIRAC effective date concerned.

GM1 AIS.TR.505(a) AIRAC

ED Decision 2020/008/R

OTHER CIRCUMSTANCES WHERE USE OF THE AIRAC SYSTEM MAY BE CONSIDERED

The AIRAC system may also be considered for the provision of information relating to the establishment and withdrawal of, and planned significant changes in, the circumstances listed below:

- (a) position, height and lighting of air navigation obstacles;
- (b) hours of service of aerodromes, facilities and services;
- (c) customs, immigration and health services;
- (d) temporary danger, prohibited and restricted areas and navigational hazards, military exercises and mass movements of aircraft; and
- (e) temporary areas or routes or portions thereof where the possibility of interception exists.

AMC1 AIS.TR.505(b) AIRAC

ED Decision 2020/008/R

MAJOR CHANGES

Whenever major changes are planned and where advance notice is desirable and possible, information should be distributed and/or made available by the AIS provider, whenever practicable, so as to reach recipients at least 56 days in advance of the AIRAC effective date. This should apply to the establishment of, and premeditated major changes in the circumstances listed below, as well as to other major changes if deemed necessary:

- (a) new aerodromes for international instrument flight rules operations;
- (b) new runways for instrument flight rules (IFR) operations at international aerodromes;
- (c) design and structure of the ATS route network;
- (d) design and structure of a set of terminal procedures (including change of procedure bearings due to magnetic variation change); and
- (e) circumstances listed in AIS.TR.505(a) if the entire State or any significant portion thereof is affected or if cross-border coordination is required.

AIS.TR.510 NOTAM

Commission Implementing Regulation (EU) 2020/469

- (a) NOTAM shall be published with sufficient lead time for the affected parties to take any required action, except in the case of unserviceability, volcanic activity, release of radioactive material, toxic chemicals and other events that cannot be foreseen.
- (b) NOTAM notifying unserviceability of aids to air navigation, facilities or communication services shall provide an estimate of the unserviceability period or of the time at which restoration of service is expected.

- (c) Within three months from the issuing of a permanent NOTAM, the information contained in the NOTAM shall be included in the aeronautical information products affected.
- (d) Within three months from the issuing of a temporary NOTAM of long duration, the information contained in the NOTAM shall be included in an AIP supplement.
- (e) When a NOTAM with an estimated end of validity unexpectedly exceeds the three-month period, a replacement NOTAM shall be issued unless the condition is expected to last for a further period of more than three months; in that case, an AIP supplement shall be issued.
- (f) A 'trigger NOTAM' shall briefly describe the content, the effective date and time, as well as the reference number of the amendment, or supplement.
- (g) A 'trigger NOTAM' shall come into force on the same effective date and time as the AIP amendment or supplement.
- (h) In case of an AIP amendment, a 'trigger NOTAM' shall remain valid for a period of 14 days.
- (i) In case of an AIP supplement that is valid for less than 14 days, the 'trigger NOTAM' shall remain valid for the complete validity period of the AIP supplement.
- (j) In case of an AIP supplement that is valid for 14 days or more, the 'trigger NOTAM' shall remain valid for at least 14 days.

GM1 AIS.TR.510(a) NOTAM

ED Decision 2020/008/R

ADVANCE NOTICE

- (a) Whenever possible, an at least 24 hours' advance notice is desirable, to permit timely completion of the notification process and to facilitate airspace utilisation planning.
- (b) Notice of any subsequent cancellation of the activities or any reduction of the hours of activity or the dimensions of the airspace should be given as soon as possible.

AIS.TR.515 Data set updates

Commission Implementing Regulation (EU) 2020/469

- (a) The update interval for the AIP data set and the instrument flight procedure data sets shall be specified in the data product specification.
- (b) Data sets that have been made available in advance, according to the AIRAC cycle, shall be updated with the non- AIRAC changes that occurred between the publication and the effective date.

APPENDICES TO ANNEX VI

Appendix 1

Regulation (EU) 2022/938

CONTENTS OF THE AERONAUTICAL INFORMATION PUBLICATION (AIP)

PART 1 – GENERAL (GEN)

When the AIP is produced as one volume, the preface, record of AIP Amendments, record of AIP Supplements, checklist of AIP pages and list of current hand amendments shall appear only in Part 1 – GEN, and the annotation ‘not applicable’ shall be entered against each of those subsections in Parts 2 and 3.

If an AIP is produced and made available in more than one volume with each having a separate amendment and supplement service, a separate preface, record of AIP Amendments, record of AIP Supplements, checklist of AIP pages and list of current hand amendments shall be included in each volume.

GEN 0.1 Preface

Brief description of the AIP, including:

1. name of the publishing organisation;
2. applicable ICAO documents;
3. publication media (i.e. printed, online or other electronic media);
4. the AIP structure and established regular amendment interval;
5. copyright policy, if applicable;
6. service to contact in case of detected AIP errors or omissions.

GEN 0.2 Record of AIP Amendments

A record of AIP Amendments and AIRAC AIP Amendments (published in accordance with the AIRAC system) containing:

1. amendment number;
2. publication date;
3. date inserted (for the AIRAC AIP Amendments, effective date);
4. initials of officer who inserted the amendment.

GEN 0.3 Record of AIP Supplements

A record of issued AIP Supplements containing:

1. Supplement number;
2. Supplement subject;
3. AIP section(s) affected;
4. period of validity;

5. cancellation record.

GEN 0.4 Checklist of AIP pages

A checklist of AIP pages containing:

1. page number/chart title;
2. publication or effective date (day, month by name and year) of the aeronautical information.

GEN 0.5 List of hand amendments to the AIP

A list of current hand amendments to the AIP containing:

1. AIP page(s) affected;
2. amendment text; and
3. AIP Amendment number by which a hand amendment was introduced.

GEN 0.6 Table of contents to Part 1

A list of sections and subsections contained in Part 1 – General (GEN).

GEN 1. NATIONAL REGULATIONS AND REQUIREMENTS**GEN 1.1 Designated authorities**

The addresses of designated authorities concerned with the facilitation of international air navigation (civil aviation, meteorology, customs, immigration, health, en-route and aerodrome/heliport charges, agricultural quarantine and aircraft accident investigation) containing, for each authority:

1. designated authority;
2. name of the authority;
3. postal address;
4. telephone number;
5. telefax number;
6. email address;
7. aeronautical fixed service (AFS) address; and
8. website address, if available.

GEN 1.2 Entry, transit and departure of aircraft

Regulations and requirements for advance notification and applications for permission concerning entry, transit and departure of aircraft on international flights.

GEN 1.3 Entry, transit and departure of passengers and crew

Regulations (including customs, immigration and quarantine, and requirements for advance notification and applications for permission) concerning entry, transit and departure of non-immigrant passengers and crew.

GEN 1.4 Entry, transit and departure of cargo

Regulations (including customs, and requirements for advance notification and applications for permission) concerning entry, transit and departure of cargo.

GEN 1.5 Aircraft instruments, equipment and flight documents

Brief description of aircraft instruments, equipment and flight documents, including:

1. instruments, equipment (including aircraft communication, navigation and surveillance equipment) and flight documents to be carried on aircraft, including any special requirement in addition to the provisions specified in Subpart D of Annex IV (Part-CAT) to Regulation (EU) No 965/2012; and
2. emergency locator transmitter (ELT), signalling devices and life-saving equipment as presented in point CAT.IDE. A.280 of Annex IV (Part-CAT) and point NCC.IDE.A.215 of Annex VI (Part-NCC) to Regulation (EU) No 965/2012, where so determined by regional air navigation meetings, for flights over designated land areas.

GEN 1.6 Summary of national regulations and International agreements/conventions

A list of titles and references and, where applicable, summaries of national regulations affecting air navigation, together with a list of international agreements/conventions ratified by Member State.

GEN 1.7 Differences from ICAO Standards, Recommended Practices and Procedures

A list of significant differences between national regulations and practices of the Member State and related ICAO provisions, including:

1. provision affected (Annex and edition number, paragraph); and
2. difference in full text.

All significant differences shall be listed under this subsection. All Annexes shall be listed in numerical order even if there is no difference to an ICAO Annex, in which case a NIL notification shall be provided. National differences or the degree of non-application of the regional supplementary procedures (SUPPs) shall be notified immediately following the Annex to which the supplementary procedure relates.

GEN 2. TABLES AND CODES**GEN 2.1 Measuring system, aircraft markings, holidays****GEN 2.1.1 Units of measurement**

Description of units of measurement used including table of units of measurement.

GEN 2.1.2 Temporal reference system

Description of the temporal reference system (calendar and time system) employed, together with an indication of whether or not daylight saving hours are employed and how the temporal reference system is presented throughout the AIP.

GEN 2.1.3 Horizontal reference system

Brief description of the horizontal (geodetic) reference system used, including:

1. name/designation of the reference system;
2. identification and parameters of the projection;
3. identification of the ellipsoid used;
4. identification of the datum used;
5. area(s) of application; and
6. an explanation, if applicable, of the asterisk used to identify those coordinates that do not meet ICAO Annex 11 and 14 accuracy requirements.

GEN 2.1.4 Vertical reference system

Brief description of the vertical reference system used, including:

1. name/designation of the reference system;
2. description of the geoid model used including the parameters required for height transformation between the model used and EGM-96;
3. an explanation, if applicable, of the asterisk used to identify those elevations/geoid undulations that do not meet ICAO Annex 14 accuracy requirements.

GEN 2.1.5 Aircraft nationality and registration marks

Indication of aircraft nationality and registration marks adopted by the Member State.

GEN 2.1.6 Public holidays

A list of public holidays with an indication of services being affected.

GEN 2.2 Abbreviations used in AIS publications

A list of alphabetically arranged abbreviations and their respective significations used by the Member State in its AIP and in the distribution of aeronautical data and aeronautical information with appropriate annotation for those national abbreviations that are different from those contained in ICAO Document 8400 'Procedures for Air Navigation Services – ICAO Abbreviations and Codes (PANS-ABC)'.

GEN 2.3 Chart symbols

A list of chart symbols arranged according to the chart series where symbols are applied.

GEN 2.4 Location indicators

A list of alphabetically arranged ICAO location indicators assigned to the locations of aeronautical fixed stations to be used for encoding and decoding purposes. An annotation to locations not connected to the aeronautical fixed service (AFS) shall be provided.

GEN 2.5 List of radio navigation aids

A list of radio navigation aids arranged alphabetically, containing:

1. identifier;
2. name of the station;
3. type of facility/aid;
4. indication whether the aid serves en-route (E), aerodrome (A) or dual (AE) purposes.

GEN 2.6 Conversion of units of measurement

Tables for conversion or, alternatively, conversion formulae between:

1. nautical miles and kilometres and vice versa;
2. feet and metres and vice versa;
3. decimal minutes of arc and seconds of arc and vice versa;
4. other conversions as appropriate.

GEN 2.7 Sunrise/sunset

Information on the time of sunrise and sunset including a brief description of criteria used for determination of the times given and either a simple formulae or table from which times may be calculated for any location within its territory/area of responsibility, or an alphabetical list of locations for which the times are given in a table with a reference to the related page in the table and the sunrise/sunset tables for the selected stations/locations, including:

1. station name;
2. ICAO location indicator;
3. geographical coordinates in degrees and minutes;
4. date(s) for which times are given;
5. time for the beginning of morning civil twilight;
6. time for sunrise;
7. time for sunset; and
8. time for the end of evening civil twilight.

GEN 3. SERVICES**GEN 3.1 Aeronautical information services****GEN 3.1.1 Responsible service**

Description of the aeronautical information service (AIS) provided and its major components, including:

1. service/unit name;
2. postal address;
3. telephone number;
4. telefax number;
5. email address;
6. AFS address;
7. website address, if available;
8. a statement concerning the provisions on which the service is based and a reference to the AIP location where differences, if any, are listed.

GEN 3.1.2 Area of responsibility

The area of responsibility for the AIS.

GEN 3.1.3 Aeronautical publications

Description of the elements of the aeronautical information products, including:

1. AIP and related amendment service;
2. AIP Supplements;
3. AIC;
4. NOTAM and pre-flight information bulletins (PIB);
5. checklists and lists of valid NOTAM;
6. how they may be obtained.

When an AIC is used to promulgate publication prices, that shall be indicated in this section of the AIP.

GEN 3.1.4 AIRAC system

Brief description of the AIRAC system provided including a table of present and near future AIRAC dates.

GEN 3.1.5 Pre-flight information service at aerodromes/heliports

A list of aerodromes/heliports at which pre-flight information is routinely available, including an indication of relevant:

1. elements of the aeronautical information products held;

2. maps and charts held;
3. general area of coverage of such data.

GEN 3.1.6 Digital data sets

1. Description of the available data sets, including:
 - a) data set title;
 - b) short description;
 - c) data subjects included;
 - d) geographical scope;
 - e) if applicable, limitations related to its usage.
2. Contact details of how data sets may be obtained, containing:
 - a) name of the individual, service or organisation responsible;
 - b) street address and email address of the individual, service or organisation responsible;
 - c) telefax number of the individual, service or organisation responsible;
 - d) contact telephone number of the individual, service or organisation responsible;
 - e) hours of service (time period including time zone when contact can be made);
 - f) online information that can be used to contact the individual, service or organisation; and
 - g) supplemental information, if necessary, on how and when to contact the individual, service or organisation.

GEN 3.2 Aeronautical charts

GEN 3.2.1 Responsible service(s)

Description of service(s) responsible for the production of aeronautical charts, including:

1. service name;
2. postal address;
3. telephone number;
4. telefax number;
5. email address;
6. AFS address;
7. website address, if available; and
8. a statement concerning the provisions on which the service is based and a reference to the AIP location where differences from ICAO, if any, are listed.

GEN 3.2.2 Maintenance of charts

Brief description of how aeronautical charts are revised and amended.

GEN 3.2.3 Purchase arrangements

Details of how charts may be obtained, containing:

1. service/sales agency(ies);
2. postal address;
3. telephone number;
4. telefax number;
5. email address;
6. AFS address;
7. website address, if available.

GEN 3.2.4 Aeronautical chart series available

A list of aeronautical chart series available followed by a general description of each series and an indication of the intended use.

GEN 3.2.5 List of aeronautical charts available A list of aeronautical charts available, including:

1. title of series;
2. scale of series;
3. name and/or number of each chart or each sheet in a series;
4. price per sheet;
5. date of latest revision.

GEN 3.2.6 Index to the World Aeronautical Chart (WAC) – ICAO 1:1 000 000

An index chart showing coverage and sheet layout for the WAC 1:1 000 000 produced by a Member State. If an Aeronautical Chart – ICAO 1:500 000 is produced instead of WAC 1:1 000 000, index charts shall be used to indicate coverage and sheet layout for the Aeronautical Chart – ICAO 1:500 000.

GEN 3.2.7 Topographical charts

Details of how topographical charts may be obtained, containing:

1. name of service/agency(ies);
2. postal address;
3. telephone number;
4. telefax number;
5. email address;
6. AFS address;
7. website address, if available.

GEN 3.2.8 Corrections to charts not contained in the AIP

A list of corrections to aeronautical charts not contained in the AIP, or an indication where such information can be obtained.

GEN 3.3 Air traffic services (ATS)

GEN 3.3.1 Responsible service

Description of the air traffic service and its major components, including:

1. service name;
2. postal address;
3. telephone number;
4. telefax number;
5. email address;
6. AFS address;
7. website address, if available;
8. a statement concerning the provisions on which the service is based and a reference to the AIP location where differences from ICAO, if any, are listed;
9. an indication if service is not available for 24 hours a day and seven days a week.

GEN 3.3.2 Area of responsibility

Brief description of area of responsibility for which ATS are provided.

GEN 3.3.3 Types of services

Brief description of main types of air traffic services provided.

GEN 3.3.4 Coordination between the operator and ATS

General conditions under which coordination between the operator and air traffic services is affected.

GEN 3.3.5 Minimum flight altitude

The criteria used to determine minimum flight altitudes.

GEN 3.3.6 ATS units address list

A list of ATS units and their addresses arranged alphabetically, containing:

1. unit name;
2. postal address;
3. telephone number;

4. telefax number;
5. email address;
6. AFS address;
7. website address, if available.

GEN 3.4 Communication and navigation services**GEN 3.4.1 Responsible service**

Description of the service responsible for the provision of telecommunication and navigation facilities, including:

1. service name;
2. postal address;
3. telephone number;
4. telefax number;
5. email address;
6. AFS address;
7. website address, if available;
8. a statement concerning the provisions on which the service is based and a reference to the AIP location where differences from ICAO, if any, are listed;
9. an indication if service is not available for 24 hours a day and seven days a week.

GEN 3.4.2 Area of responsibility

Brief description of area of responsibility for which telecommunication service is provided.

GEN 3.4.3 Types of service

Brief description of the main types of service and facilities provided, including:

1. radio navigation services;
2. voice and/or data link services;
3. broadcasting service;
4. language(s) used; and
5. an indication of where detailed information can be obtained.

GEN 3.4.4 Requirements and conditions

Brief description concerning the requirements and conditions under which the communication service is available.

GEN 3.4.5 Miscellaneous

Any additional information (e.g. selected radio broadcasting stations, telecommunications diagram).

GEN 3.5 Meteorological services

GEN 3.5.1 Responsible service

Brief description of the meteorological service responsible for the provision of meteorological information, including:

1. service name;
2. postal address;
3. telephone number;
4. telefax number;
5. email address;
6. AFS address;
7. website address, if available;
8. a statement concerning the provisions on which the service is based and a reference to the AIP location where differences, if any, are listed;
9. an indication if service is not available for 24 hours a day and seven days a week.

GEN 3.5.2 Area of responsibility

Brief description of area and/or air routes for which meteorological service is provided.

GEN 3.5.3 Meteorological observations and reports

Detailed description of the meteorological observations and reports provided for international air navigation, including:

1. name of the station and the ICAO location indicator;
2. type and frequency of observation including an indication of automatic observing equipment;
3. types of meteorological reports and availability of a TREND forecast;
4. specific type of observation system and number of observation sites used to observe and report surface wind, visibility, runway visual range, cloud base, temperature and, where applicable, wind shear (e.g. anemometer at intersection of runways, transmissometers next to touchdown zone, etc.);
5. hours of operation;
6. indication of aeronautical climatological information available.

GEN 3.5.4 Types of services

Brief description of the main types of service provided, including details of briefing, consultation, display of meteorological information, flight documentation available for operators and flight crew members, and of the methods and means used for supplying the meteorological information.

GEN 3.5.5 Notification required from operators

Minimum amount of advance notice required by the meteorological service provider from operators in respect of briefing, consultation and flight documentation and other meteorological information they require or change.

GEN 3.5.6 Aircraft reports

As necessary, requirements of the meteorological service provider for the making and transmission of aircraft reports.

GEN 3.5.7 VOLMET service

Description of VOLMET and/or D-VOLMET service, including:

1. name of transmitting station;
2. call sign or identification and abbreviation for the radio communication emission;
3. frequency or frequencies used for broadcast;
4. broadcasting period;
5. hours of service;
6. list of aerodromes/heliports for which reports and/or forecasts are included; and
7. reports, forecasts and SIGMET information included and remarks.

GEN 3.5.8 SIGMET and AIRMET service

Description of the meteorological watch provided within flight information regions or control areas for which air traffic services are provided, including a list of the meteorological watch offices with:

1. name of the meteorological watch office, ICAO location indicator;
2. hours of service;
3. flight information region(s) or control area(s) served;
4. SIGMET validity periods;
5. specific procedures applied to SIGMET information (e.g. for volcanic ash and tropical cyclones);
6. procedures applied to AIRMET information (in accordance with relevant regional air navigation agreements);
7. the ATS unit(s) provided with SIGMET and AIRMET information;
8. additional information, such as any limitation of service, etc.

GEN 3.5.9 Other automated meteorological services

Description of available automated services for the provision of meteorological information (e.g. automated pre-flight information service accessible by telephone and/or computer modem) including:

1. service name;
2. information available;
3. areas, routes and aerodromes covered;
4. telephone and telefax number(s), email address, and, if available, website address.

GEN 3.6 Search and rescue (SAR)

GEN 3.6.1 Responsible service(s)

Brief description of service(s) responsible for the provision of search and rescue (SAR), including:

1. service/unit name;
2. postal address;
3. telephone number;
4. telefax number;
5. email address;
6. AFS address;
7. website address, if available; and
8. a statement concerning the provisions on which the service is based and a reference to the AIP location where differences from ICAO, if any, are listed.

GEN 3.6.2 Area of responsibility

Brief description of area of responsibility within which SAR services are provided.

GEN 3.6.3 Types of service

Brief description and geographical portrayal, where appropriate, of the type of service and facilities provided including indications where SAR aerial coverage is dependent upon significant deployment of aircraft.

GEN 3.6.4 SAR agreements

Brief description of SAR agreements in force, including provisions for facilitating entry and departure of other Member States' aircraft for search, rescue, salvage, repair or salvage in connection with lost or damaged aircraft, either with airborne notification only or after flight plan notification.

GEN 3.6.5 Conditions of availability

Brief description of provisions for SAR, including the general conditions under which the service and facilities are available for international use, including an indication of whether a facility available for SAR is specialised in SAR techniques and functions, or is specially used for other purposes but adapted for SAR purposes by training and equipment, or is only occasionally available and has no particular training or preparation for SAR work.

GEN 3.6.6 Procedures and signals used

Brief description of the procedures and signals used by rescue aircraft and a table showing the signals to be used by survivors.

GEN 4. CHARGES FOR AERODROMES/HELIPORTS AND AIR NAVIGATION SERVICES (ANS)

Reference may be made to where details of actual charges may be found, if not itemised in this chapter.

GEN 4.1 Aerodrome/heliport charges

Brief description of type of charges which may be applicable at aerodromes/heliports available for international use, including:

1. landing of aircraft;
2. parking, hangarage and long-term storage of aircraft;
3. passenger service;
4. security;
5. noise-related items;
6. other (customs, health, immigration, etc.);
7. exemptions/reductions; and
8. methods of payment.

GEN 4.2 Air navigation services charges

Brief description of charges that may be applicable to ANS provided for international use, including:

1. approach control;
2. ANS route;
3. cost basis for ANS and exemptions/reductions;
4. methods of payment.

PART 2 – EN-ROUTE (ENR)

If an AIP is produced and made available in more than one volume with each having a separate amendment and supplement service, a separate preface, record of AIP Amendments, record of AIP Supplements, checklist of AIP pages and list of current hand amendments shall be included in each volume. In the case of an AIP being published as one volume, the annotation ‘not applicable’ shall be entered against each of the above subsections.

ENR 0.6 Table of contents to Part 2

A list of sections and subsections contained in Part 2 – En-route.

ENR 1. GENERAL RULES AND PROCEDURES

ENR 1.1 General rules

The general rules shall be published as applied within the Member State.

ENR 1.2 Visual flight rules

The visual flight rules shall be published as applied within the Member State.

ENR 1.3 Instrument flight rules

The instrument flight rules shall be published as applied within the Member State.

ENR 1.3.1 Rules applicable to all IFR flights

ENR 1.3.2 Rules applicable to IFR flights within controlled airspace

ENR 1.3.3 Rules applicable to IFR flights outside controlled airspace

ENR 1.3.4 Free route airspace (FRA) general procedures

Procedures related to the free route airspace, including explanation and definitions of applied FRA relevant points. In case of cross-border FRA implementation, the involved FIRs/UIRs or CTAs/UTAs shall be indicated in point ENR 1.3.

ENR 1.4 ATS airspace classification and description

ENR 1.4.1 ATS airspace classification

The description of ATS airspace classes in the form of the ATS airspace classification table in Appendix 4 to Implementing Regulation (EU) No 923/2012, appropriately annotated to indicate those airspace classes not used by the Member State.

ENR 1.4.2 ATS airspace description

Other ATS airspace descriptions, as applicable, including general textual descriptions.

ENR 1.5 Holding, approach and departure procedures

ENR 1.5.1 General

The requirement is for a statement concerning the criteria on which holding, approach and departure procedures are established.

ENR 1.5.2 Arriving flights

Procedures (conventional or area navigation or both) for arriving flights which are common to flights into or within the same type of airspace shall be presented. If different procedures apply within a terminal airspace, a note to this effect shall be given together with a reference to where the specific procedures can be found.

ENR 1.5.3 Departing flights

Procedures (conventional or area navigation or both) for departing flights which are common to flights departing from any aerodrome/heliport shall be presented.

ENR 1.5.4 Other relevant information and procedures

Brief description of additional information, e.g. entry procedures, final approach alignment, holding procedures and patterns.

ENR 1.6 ATS surveillance services and procedures

ENR 1.6.1 Primary radar

Description of primary radar services and procedures, including:

1. supplementary services;
2. the application of radar control service;
3. radar and air-ground communication failure procedures;
4. voice and controller-pilot data link communications (CPDLC) position reporting requirements; and
5. graphic portrayal of the area of radar coverage.

ENR 1.6.2 Secondary surveillance radar (SSR)

Description of secondary surveillance radar (SSR) operating procedures, including:

1. emergency procedures;
2. air-ground communication failure and unlawful interference procedures;

3. the system of SSR code assignment;
4. voice and CPDLC position reporting requirements; and
5. graphic portrayal of the area of SSR coverage.

ENR 1.6.3 Automatic dependent surveillance – broadcast (ADS-B)

Description of automatic dependent surveillance – broadcast (ADS-B) operating procedures, including:

1. emergency procedures;
2. air-ground communication failure and unlawful interference procedures;
3. aircraft identification requirements;
4. voice and CPDLC position reporting requirements; and
5. graphic portrayal of the area of ADS-B coverage.

ENR 1.6.4 Other relevant information and procedures

Brief description of additional information and procedures, e.g. radar failure procedures and transponder failure procedures.

ENR 1.7 Altimeter setting procedures

A statement of altimeter setting procedures in use shall be published, containing:

1. brief introduction with a statement concerning the ICAO documents on which the procedures are based together with differences to ICAO provisions, if any;
2. basic altimeter setting procedures;
3. description of altimeter setting region(s);
4. procedures applicable to operators (including pilots); and
5. table of cruising levels.

ENR 1.8 ICAO regional supplementary procedures

Regional supplementary procedures (SUPPs) affecting the entire area of responsibility shall be presented.

ENR 1.9 Air traffic flow management (ATFM) and airspace management

Brief description of ATFM system and airspace management, including:

1. ATFM structure, service area, service provided, location of unit(s) and hours of operation;
2. types of flow messages and descriptions of the formats; and
3. procedures applicable to departing flights, containing:
 - a) service responsible for provision of information on applied ATFM measures;

- b) flight plan requirements; and
 - c) slot allocations.
4. information on overall responsibility regarding airspace management within FIR(s), details of civil/military airspace allocation and management coordination, structure of manageable airspace (allocation and changes to allocation) and general operating procedures.

ENR 1.10 Flight planning

Any restriction, limitation or advisory information related to the flight planning stage which may assist the user in the presentation of the intended flight operation shall be indicated, including:

1. procedures for the submission of a flight plan;
2. repetitive flight plan system; and
3. changes to the submitted flight plan.

ENR 1.11 Addressing of flight plan messages

An indication, in tabular form, of the addresses allocated to flight plans shall be included, showing:

1. category of flight (IFR, VFR or both);
2. route (into or via FIR and/or TMA); and
3. message address.

ENR 1.12 Interception of civil aircraft

A complete statement of interception procedures and visual signals to be used shall be indicated with a clear indication of whether ICAO provisions are applied and, if not, that differences exist.

ENR 1.13 Unlawful interference

Appropriate procedures to be applied in case of unlawful interference shall be presented.

ENR 1.14 Air traffic incidents

Description of air traffic incidents reporting system, including:

1. definition of air traffic incidents;
2. use of the 'Air Traffic Incident Reporting Form';
3. reporting procedures (including in-flight procedures); and
4. purpose of reporting and handling of the form.

ENR 2. AIR TRAFFIC SERVICES AIRSPACE**ENR 2.1 FIR, UIR, TMA and CTA**

Detailed description of flight information regions (FIRs), upper flight information regions (UIRs), and control areas (CTAs) (including specific CTAs such as TMAs), including:

1. name, geographical coordinates in degrees and minutes of the FIR/UIR lateral limits and in degrees, minutes and seconds of the CTA lateral limits, vertical limits and class of airspace;
2. identification of unit providing the service;
3. call sign of aeronautical station serving the unit and language(s) used, specifying the area and conditions, when and where to be used, if applicable;
4. frequencies, and if applicable SATVOICE number, supplemented by indications for specific purposes; and
5. remarks.

Control zones around military air bases not otherwise described in the AIP shall be included in this subsection. Where the requirements of Implementing Regulation (EU) No 923/2012 concerning flight plans, two-way communications and position reporting apply to all flights in order to eliminate or reduce the need for interceptions and/or where the possibility of interception exists and the maintenance of guard on the VHF emergency frequency 121.500 MHz is required, a statement to this effect shall be included for the relevant area(s) or portion(s) thereof.

A description of designated areas over which the carriage of an emergency locator transmitter (ELT) is required and where aircraft shall continuously guard the VHF emergency frequency 121.500 MHz, except for those periods when aircraft are carrying out communications on other VHF channels or when airborne equipment limitations or cockpit duties do not permit simultaneous guarding of two channels.

ENR 2.2 Other regulated airspace

Detailed description of radio mandatory zones (RMZs) and transponder mandatory zones (TMZs), including:

1. name, geographical coordinates in degrees and minutes of the RMZ/TMZ lateral limits;
2. vertical limits in flight levels, or feet;
3. time of activity; and
4. remarks.

Where established, a detailed description of other types of regulated airspace and airspace classification.

ENR 3. ATS ROUTES

ENR 3.1 Conventional navigation routes

Detailed description of conventional navigation routes, including:

1. route designator, designation of the required communication performance (RCP) specification(s), required surveillance performance (RSP) specification(s) applicable to a specified segment(s), names, coded designators or name-codes and the geographical coordinates in degrees, minutes and seconds of all significant points defining the route including 'compulsory' or 'on-request' reporting points;
2. tracks or VOR radials to the nearest degree, geodesic distance to the nearest tenth of a kilometre or tenth of a nautical mile between each successive designated significant point and, in the case of VOR radials, changeover points;

3. upper and lower limits or minimum en-route altitudes, to the nearest higher 50 m or 100 ft, and airspace classification;
4. lateral limits and minimum obstacle clearance altitudes;
5. direction of cruising levels;
6. remarks, including an indication of the controlling unit, its operating channel and, if applicable, its logon address, SATVOICE number, and any navigation RCP and RSP specification(s) limitations.

ENR 3.2 Area navigation routes

Detailed description of PBN (RNAV and RNP) routes, including:

1. route designator, designation of the required communication performance (RCP) specification(s), navigation specification(s) and/or required surveillance performance (RSP) specification(s) applicable to a specified segment(s), names, coded designators or name-codes and the geographical coordinates in degrees, minutes and seconds of all significant points defining the route including 'compulsory' or 'on-request' reporting points;
2. in respect of waypoints defining an area navigation route, additionally as applicable:
 - a) station identification of the reference VOR/DME;
 - b) bearing to the nearest degree and the distance to the nearest tenth of a kilometre or tenth of a nautical mile from the reference VOR/DME if the waypoint is not collocated with it;
 - c) elevation of the transmitting antenna of DME to the nearest 30 m (100 ft);
3. magnetic reference bearing to the nearest degree, geodesic distance to the nearest tenth of a kilometre or tenth of a nautical mile between defined end points and distance between each successive designated significant point;
4. upper and lower limits and airspace classification;
5. direction of cruising levels;
6. the navigation accuracy requirement for each PBN (RNAV or RNP) route segment;
7. remarks, including an indication of the controlling unit, its operating channel and, if applicable, its logon address, SATVOICE number and any navigation, RCP and RSP specification(s) limitations.

ENR 3.3 Other routes

The requirement is to describe other specifically designated routes which are compulsory within specified area(s).

Description of free route airspace (FRA), as specified airspace within which users may freely plan direct routes between a defined entry point and a defined exit point, including information on the direct routing, the restrictions on the use of waypoints for direct routings and the indication in the flight plan (item 15). The prerequisites for the issuance of ATC clearances shall be described.

ENR 3.4 En-route holding

The requirement is for a detailed description of en-route holding procedures, containing:

1. holding identification (if any) and holding fix (navigation aid) or waypoint with geographical coordinates in degrees, minutes and seconds;
2. inbound track;

3. direction of the procedure turn;
4. maximum indicated airspeed;
5. minimum and maximum holding level;
6. time/distance outbound;
7. indication of the controlling unit and its operating frequency.

ENR 4. RADIO NAVIGATION AIDS/SYSTEMS

ENR 4.1 Radio navigation aids – en-route

A list of stations providing radio navigation services established for en-route purposes and arranged alphabetically by name of the station, including:

1. name of the station and magnetic variation to the nearest degree and for VOR, station declination to the nearest degree, used for technical line-up of the aid;
2. identification;
3. frequency/channel for each element;
4. hours of operation;
5. geographical coordinates in degrees, minutes and seconds of the position of the transmitting antenna;
6. elevation of the transmitting antenna of DME to the nearest 30 m (100 ft); and
7. remarks.

If the operating authority of the facility is other than the designated authority, the name of the operating authority shall be indicated in the remarks column. Facility coverage shall be indicated in the remarks column.

ENR 4.2 Special navigation systems

Description of stations associated with special navigation systems, including:

1. name of station or chain;
2. type of service available (master signal, slave signal, colour);
3. frequency (channel number, basic pulse rate, recurrence rate, as applicable);
4. hours of operation;
5. geographical coordinates in degrees, minutes and seconds of the position of the transmitting station; and
6. remarks.

If the operating authority of the facility is other than the designated authority, the name of the operating authority shall be indicated in the remarks column. Facility coverage shall be indicated in the remarks column.

ENR 4.3 Global navigation satellite system (GNSS)

A list and description of elements of the global navigation satellite system (GNSS) providing the navigation service established for en-route purposes and arranged alphabetically by name of the element, including:

1. the name of the GNSS element (GPS, GLONASS, EGNOS, MSAS, WAAS, etc.);
2. frequency(ies), as appropriate;
3. geographical coordinates in degrees, minutes and seconds of the nominal service area and coverage area; and
4. remarks.

If the operating authority of the facility is other than the designated authority, the name of the operating authority shall be indicated in the remarks column.

ENR 4.4 Name-code designators for significant points

An alphabetically arranged list of name-code designators (five-letter pronounceable 'name-code') established for significant points at positions not marked by the site of radio navigation aids, including:

1. name-code designator;
2. geographical coordinates of the position in degrees, minutes and seconds;
3. reference to ATS or other routes where the point is located; and
4. remarks, including a supplementary definition of positions, where required.

ENR 4.5 Aeronautical ground lights – en-route

A list of aeronautical ground lights and other light beacons designating geographical positions that are selected by the Member State as being significant, including:

1. name of the city or town or other identification of the beacon;
2. type of beacon and intensity of the light in thousands of candelas;
3. characteristics of the signal;
4. operational hours; and
5. remarks.

ENR 5. NAVIGATION WARNINGS**ENR 5.1 Prohibited, restricted and danger areas**

Description, supplemented by graphic portrayal, where appropriate, of prohibited, restricted and danger areas together with information regarding their establishment and activation, including:

1. identification, name and geographical coordinates of the lateral limits in degrees, minutes and seconds, if inside, and in degrees and minutes, if outside control area/control zone boundaries;
2. upper and lower limits; and
3. remarks, including time of activity.

Type of restriction or nature of hazard and risk of interception in the event of penetration shall be indicated in the remarks column.

ENR 5.2 Military exercise and training areas and air defence identification zone (ADIZ)

Description, supplemented by graphic portrayal, where appropriate, of established military training areas and military exercises taking place at regular intervals, and established air defence identification zone (ADIZ), including:

1. geographical coordinates of the lateral limits in degrees, minutes and seconds, if inside, and in degrees and minutes, if outside control area/control zone boundaries;
2. upper and lower limits, and system and means of activation announcements together with information pertinent to civil flights and applicable ADIZ procedures; and
3. remarks, including time of activity and risk of interception in the event of penetration of ADIZ.

ENR 5.3 Other activities of a dangerous nature and other potential hazards

ENR 5.3.1 Other activities of a dangerous nature

Description, supplemented by charts where appropriate, of activities that constitute a specific or obvious danger to aircraft operation and could affect flights, including:

1. geographical coordinates in degrees and minutes of centre of area and range of influence;
2. vertical limits;
3. advisory measures;
4. authority responsible for the provision of information; and
5. remarks, including time of activity.

ENR 5.3.2 Other potential hazards

Description, supplemented by charts where appropriate, of other potential hazards that could affect flights (e.g. active volcanoes, nuclear power stations, etc.), including:

1. geographical coordinates in degrees and minutes of location of potential hazard;
2. vertical limits;
3. advisory measures;
4. authority responsible for the provision of information; and
5. remarks.

ENR 5.4 Air navigation obstacles

The list of obstacles affecting air navigation in Area 1 (the entire Member State territory), including:

1. obstacle identification or designation;
2. type of obstacle;
3. obstacle position, represented by geographical coordinates in degrees, minutes and seconds;

4. obstacle elevation and height to the nearest metre or foot;
5. type and colour of obstacle lighting (if any); and
6. if appropriate, an indication that the list of obstacles is available in electronic form, and a reference to point GEN 3.1.6.

ENR 5.5 Aerial sporting and recreational activities

Brief description, supplemented by graphic portrayal where appropriate, of intensive aerial sporting and recreational activities together with conditions under which they are carried out, including:

1. designation and geographical coordinates of the lateral limits in degrees, minutes and seconds, if inside, and in degrees and minutes, if outside, control area/control zone boundaries;
2. vertical limits;
3. operator/user telephone number; and
4. remarks, including time of activity.

ENR 5.6 Bird migration and areas with sensitive fauna

Description, supplemented by charts where practicable, of movements of birds associated with migration, including migration routes and permanent resting areas and areas with sensitive fauna.

ENR 6. EN-ROUTE CHARTS

The ICAO En-route Chart and index charts shall be included in this section.

PART 3 – AERODROMES (AD)

If an AIP is produced and made available in more than one volume with each having a separate amendment and supplement service, a separate preface, record of AIP Amendments, record of AIP Supplements, checklist of AIP pages and list of current hand amendments shall be included in each volume. In the case of an AIP being published as one volume, the annotation ‘not applicable’ shall be entered against each of the above subsections.

AD 0.6 Table of contents to Part 3

A list of sections and subsections contained in Part 3 – Aerodromes (AD).

AD 1. AERODROMES/HELIPORTS – INTRODUCTION

AD 1.1 Aerodrome/heliport availability and conditions of use

AD 1.1.1 General conditions

Brief description of the competent authority responsible for aerodromes and heliports, including:

1. the general conditions under which aerodromes/heliports and associated facilities are available for use; and
2. a statement concerning the provisions on which the services are based and a reference to the AIP location where differences from ICAO, if any, are listed.

AD 1.1.2 Use of military air bases

Regulations and procedures, if any, concerning civil use of military air bases.

AD 1.1.3 Low-visibility procedures (LVPs)

The general conditions under which the LVPs applicable to low-visibility operations, at aerodromes, if any, are applied.

AD 1.1.4 Aerodrome operating minima

Details of aerodrome operating minima applied by the Member State.

AD 1.1.5 Other information

If applicable, other information of a similar nature.

AD 1.2 Rescue and firefighting services (RFFSs), runway surface condition assessment and reporting, and snow plan

AD 1.2.1 Rescue and firefighting services

Brief description of rules governing the establishment of RFFSs at aerodromes/heliports available for public use together with an indication of rescue and firefighting categories established by a Member State.

AD 1.2.2 Runway surface condition assessment and reporting, and snow plan

Description of runway surface condition assessment and reporting; and brief snow plan considerations for aerodromes/heliports available for public use at which snow conditions are normally liable to occur, including:

1. organisation of the runway surface condition reporting and winter service;

2. surveillance of movement areas;
3. surface condition assessment methods used; operations on specially prepared winter runways;
4. actions taken to maintain the usability of movement areas;
5. system and means of reporting;
6. the cases of runway closure;
7. distribution of information about runway surface conditions.

AD 1.3 Index of aerodromes and heliports

A list, supplemented by graphic portrayal, of aerodromes/heliports within a Member State, including:

1. aerodrome/heliport name and ICAO location indicator;
2. type of traffic permitted to use the aerodrome/heliport (international/national, IFR/VFR, scheduled/non-scheduled, general aviation, military and other);
3. reference to AIP, Part 3 subsection in which aerodrome/heliport details are presented.

AD 1.4 Grouping of aerodromes/heliports

Brief description of the criteria applied by the Member State in grouping aerodromes/heliports for production/distribution/provision of information purposes.

AD 1.5 Status of certification of aerodromes

A list of aerodromes in the Member State, indicating the status of certification, including:

1. aerodrome name and ICAO location indicator;
2. date and, if applicable, validity of certification;
3. remarks, if any.

AD 2. AERODROMES

Note.— **** is to be replaced by the relevant ICAO location indicator.
--

****** AD 2.1 Aerodrome location indicator and name**

The ICAO location indicator allocated to the aerodrome and the name of aerodrome shall be indicated. An ICAO location indicator shall be an integral part of the referencing system applicable to all subsections in section AD 2.

****** AD 2.2 Aerodrome geographical and administrative data**

Aerodrome geographical and administrative data shall be published, including:

1. aerodrome reference point (geographical coordinates in degrees, minutes and seconds) and its site;
2. direction and distance of aerodrome reference point from centre of the city or town that the aerodrome serves;
3. aerodrome elevation to the nearest metre or foot, and reference temperature;

4. where appropriate, geoid undulation at the aerodrome elevation position to the nearest metre or foot;
5. magnetic variation to the nearest degree, date of information and annual change;
6. name of aerodrome operator, address, telephone and telefax numbers, email address, AFS address and, if available, website address;
7. types of traffic permitted to use the aerodrome (IFR/VFR); and
8. remarks.

****** AD 2.3 Operational hours**

Detailed description of the hours of operation of services at the aerodrome, including:

1. aerodrome operator;
2. customs and immigration;
3. health and sanitation;
4. AIS briefing office;
5. ATS reporting office (ARO);
6. MET briefing office;
7. ATS;
8. fuelling;
9. handling;
10. security;
11. de-icing; and
12. remarks.

****** AD 2.4 Handling services and facilities**

Detailed description of the handling services and facilities available at the aerodrome, including:

1. cargo-handling facilities;
2. fuel and oil types;
3. fuelling facilities and capacity;
4. de-icing facilities;
5. hangar space for visiting aircraft;
6. repair facilities for visiting aircraft;
7. remarks.

****** AD 2.5 Passenger facilities**

Passenger facilities available at the aerodrome, provided as a brief description or a reference to other information sources such as a website, including:

1. hotel(s) at or in the vicinity of the aerodrome;
2. restaurant(s) at or in the vicinity of the aerodrome;
3. transportation possibilities;
4. medical facilities;
5. bank and post office at or in the vicinity of the aerodrome;
6. tourist office;
7. remarks.

****** AD 2.6 Rescue and firefighting services**

Detailed description of the RFFSs and equipment available at the aerodrome, including:

1. aerodrome category for firefighting;
2. rescue equipment;
3. capability for removal of disabled aircraft; and
4. remarks.

****** AD 2.7 Runway surface condition assessment and reporting, and snow plan**

Information on runway surface condition assessment and reporting.

Detailed description of the equipment and operational priorities established for the clearance of aerodrome movement areas, including:

1. type(s) of clearing equipment;
2. clearance priorities;
3. use of material for movement area surface treatment;
4. specially prepared winter runways;
5. remarks.

****** AD 2.8 Aprons, taxiways and check locations/positions data**

Details related to the physical characteristics of aprons, taxiways and locations/positions of designated checkpoints, including:

1. designation, surface and strength of aprons;
2. designation, width, surface and strength of taxiways;
3. location and elevation to the nearest metre or foot of altimeter checkpoints;
4. location of VOR checkpoints;
5. position of INS checkpoints in degrees, minutes, seconds and hundredths of seconds;
6. remarks.

If check locations/positions are presented on an aerodrome chart, a note to that effect shall be provided under this subsection.

****** AD 2.9 Surface movement guidance and control system and markings**

Brief description of the surface movement guidance and control system and runway and taxiway markings, including:

1. use of aircraft stand identification signs, taxiway guide lines and visual docking/parking guidance system at aircraft stands;
2. runway and taxiway markings and lights;
3. stop bars (if any);
4. remarks.

****** AD 2.10 Aerodrome obstacles**

Detailed description of obstacles, including:

1. obstacles in Area 2:
 - a) obstacle identification or designation;
 - b) type of obstacle;
 - c) obstacle position, represented by geographical coordinates in degrees, minutes, seconds and tenths of seconds;
 - d) obstacle elevation and height to the nearest metre or foot;
 - e) obstacle marking, and type and colour of obstacle lighting (if any);
 - f) if appropriate, an indication that the list of obstacles is available in electronic form, and a reference to point GEN 3.1.6; and
 - g) 'NIL' indication, if appropriate.
2. the absence of an Area 2 data set for the aerodrome is to be clearly stated and obstacle data are to be provided for:
 - a) obstacles that penetrate the obstacle limitation surfaces;
 - b) obstacles that penetrate the take-off flight path area obstacle identification surface; and
 - c) other obstacles assessed as being hazardous to air navigation.
3. indication that information on obstacles in Area 3 is not provided, or if provided:
 - a) obstacle identification or designation;
 - b) type of obstacle;
 - c) obstacle position, represented by geographical coordinates in degrees, minutes, seconds and tenths of seconds;
 - d) obstacle elevation and height to the nearest tenth of a metre or tenth of a foot;
 - e) obstacle marking, and type and colour of obstacle lighting (if any);
 - f) if appropriate, an indication that the list of obstacles is available in electronic form, and a reference to point GEN 3.1.6; and
 - g) 'NIL' indication, if appropriate.

****** AD 2.11 Meteorological information provided**

Detailed description of meteorological information provided at the aerodrome and an indication of which meteorological office is responsible for the service enumerated, including:

1. name of the associated meteorological office;
2. hours of service and, where applicable, the designation of the responsible meteorological office outside these hours;
3. office responsible for preparation of TAFs and periods of validity and interval of issuance of the forecasts;
4. availability of the TREND forecasts for the aerodrome, and interval of issuance;
5. information on how briefing and/or consultation is provided;
6. types of flight documentation supplied and language(s) used in flight documentation;
7. charts and other information displayed or available for briefing or consultation;
8. supplementary equipment available for providing information on meteorological conditions, such as weather radar and receiver for satellite images;
9. the ATS unit(s) provided with meteorological information; 10) additional information such as any limitation of service,

****** AD 2.12 Runway physical characteristics**

Detailed description of runway physical characteristics, for each runway, including:

1. designations;
2. true bearings to one-hundredth of a degree;
3. dimensions of runways to the nearest metre or foot;
4. strength of pavement (pavement classification number (PCN) and associated data) and surface of each runway and associated stopways;
5. geographical coordinates in degrees, minutes, seconds and hundredths of seconds for each threshold and runway end and, where appropriate, geoid undulation of:
 - thresholds of a non-precision approach runway to the nearest metre or foot; and
 - thresholds of a precision approach runway to the nearest tenth of a metre or tenth of a foot;
6. elevations of:
 - thresholds of a non-precision approach runway to the nearest metre or foot; and
 - thresholds and the highest elevation of the touchdown zone of a precision approach runway to the nearest tenth of a metre or tenth of a foot;
7. slope of each runway and associated stopways;
8. dimensions of stopway (if any) to the nearest metre or foot;
9. dimensions of clearway (if any) to the nearest metre or foot;
10. dimensions of strips;
11. dimensions of runway end safety areas;

12. location (which runway end) and description of arresting system (if any);
13. the existence of an obstacle-free zone; and
14. remarks.

****** AD 2.13 Declared distances**

Detailed description of declared distances to the nearest metre or foot for each direction of each runway, including:

1. runway designator;
2. take-off run available;
3. take-off distance available and, if applicable, alternative reduced declared distances;
4. accelerate-stop distance available;
5. landing distance available; and
6. remarks, including runway entry or start point where alternative reduced declared distances have been declared.

If a runway direction cannot be used for take-off or landing, or both because it is operationally forbidden, then this shall be declared and the words 'not usable' or the abbreviation 'NU' entered.

****** AD 2.14 Approach and runway lighting**

Detailed description of approach and runway lighting, including:

1. runway designator;
2. type, length and intensity of approach lighting system;
3. runway threshold lights, colour and wing bars;
4. type of visual approach slope indicator system;
5. length of runway touchdown zone lights;
6. length, spacing, colour and intensity of runway centre line lights;
7. length, spacing, colour and intensity of runway edge lights;
8. colour of runway end lights and wing bars;
9. length and colour of stopway lights; and
10. remarks.

****** AD 2.15 Other lighting, secondary power supply**

Description of other lighting and secondary power supply, including:

1. location, characteristics and hours of operation of aerodrome beacon/identification beacon (if any);
2. location and lighting (if any) of anemometer/landing direction indicator;
3. taxiway edge and taxiway centre line lights;

4. secondary power supply including switchover time; and
5. remarks.

****** AD 2.16 Helicopter landing area**

Detailed description of helicopter landing area provided at the aerodrome, including:

1. geographical coordinates in degrees, minutes, seconds and hundredths of seconds and, where appropriate, geoid undulation of the geometric centre of touchdown and lift-off (TLOF) or of each threshold of final approach and take-off (FATO) area:
 - for non-precision approaches, to the nearest metre or foot; and
 - for precision approaches, to the nearest tenth of a metre or tenth of a foot;
2. TLOF and/or FATO area elevation:
 - for non-precision approaches, to the nearest metre or foot; and
 - for precision approaches, to the nearest tenth of a metre or tenth of a foot;
3. TLOF and FATO area dimensions to the nearest metre or foot, surface type, bearing strength and marking;
4. true bearings to one-hundredth of a degree of FATO;
5. declared distances available, to the nearest metre or foot;
6. approach and FATO lighting; and
7. remarks.

****** AD 2.17 Air traffic services airspace**

Detailed description of ATS airspace organised at the aerodrome, including:

1. airspace designation and geographical coordinates in degrees, minutes and seconds of the lateral limits;
2. vertical limits;
3. airspace classification;
4. call sign and language(s) of the ATS unit providing service;
5. transition altitude;
6. hours of applicability; and
7. remarks.

****** AD 2.18 Air traffic services communication facilities**

Detailed description of ATS communication facilities established at the aerodrome, including:

1. service designation;
2. call sign;
3. channel(s);

4. SATVOICE number(s), if available;
5. logon address, as appropriate;
6. hours of operation; and
7. remarks.

****** AD 2.19 Radio navigation and landing aids**

Detailed description of radio navigation and landing aids associated with the instrument approach and the terminal area procedures at the aerodrome, including:

1.
 - a) type of aids;
 - b) magnetic variation to the nearest degree, as appropriate;
 - c) type of supported operation for ILS/MLS/GLS, basic GNSS and SBAS;
 - d) classification for ILS;
 - e) facility classification and approach facility designation(s) for GBAS;
 - f) for VOR/ILS/MLS, also station declination to the nearest degree used for technical line-up of the aid;
2. identification, if required;
3. frequency(ies), channel number(s), service provider and reference path identifier(s) (RPI(s)), as appropriate;
4. hours of operation, as appropriate;
5. geographical coordinates in degrees, minutes, seconds and tenths of seconds of the position of the transmitting antenna, as appropriate;
6. elevation of the DME transmitting antenna to the nearest 30 m (100 ft) and of the distance-measuring equipment precision (DME/P) to the nearest 3 m (10 ft), elevation of GBAS reference point to the nearest metre or foot, and the ellipsoid height of the point to the nearest metre or foot; for SBAS, the ellipsoid height of the landing threshold point (LTP) or the fictitious threshold point (FTP) to the nearest metre or foot;
7. service volume radius from the GBAS reference point to the nearest kilometre or nautical mile;
8. remarks.

When the same aid is used for both en-route and aerodrome purposes, a description shall also be given in section ENR 4. If the ground-based augmentation system (GBAS) serves more than one aerodrome, a description of the aid shall be provided under each aerodrome. If the operating authority of the facility is other than the designated authority, the name of the operating authority shall be indicated in the remarks column. Facility coverage shall be indicated in the remarks column.

****** AD 2.20 Local aerodrome regulations**

Detailed description of regulations applicable to the use of the aerodrome, including the acceptability of training flights, non-radio and microlight aircraft and similar, and to ground manoeuvring and parking but excluding flight procedures.

****** AD 2.21 Noise abatement procedures**

Detailed description of noise abatement procedures established at the aerodrome.

****** AD 2.22 Flight procedures**

Detailed description of the conditions and flight procedures, including radar and/or ADS-B procedures, established on the basis of airspace organisation at the aerodrome. When established, detailed description of the LVP at the aerodrome, including:

1. runway(s) and associated equipment authorised for use when LVP are in effect, including for operations with operational credits with RVR less than 550 m, if applicable;
2. defined meteorological conditions under which initiation, use and termination of LVP would be made;
3. description of ground marking/lighting for use under LVP;
4. remarks.

****** AD 2.23 Additional information**

Additional information at the aerodrome, such as an indication of bird concentrations at the aerodrome, together with an indication of significant daily movement between resting and feeding areas, to the extent practicable.

Specific additional information regarding remote aerodrome ATS:

1. indication that remote aerodrome ATS is provided;
2. location of the signalling lamp by e.g. the phrase 'signalling lamp positioned at [geographical fix]' as well as a clear indication of the signalling lamp location in the aerodrome chart for each relevant aerodrome;
3. description of any specific communication methods as deemed necessary in case of multiple mode of operation, such as e.g. the inclusion of airport names/ATS unit call sign for all transmissions (i.e. not only for the first contact) between pilots and ATCOs/aerodrome flight information service offices (AFISOs);
4. description of any relevant actions required by the airspace users following an emergency/abnormal situation and possible contingency measures by the ATS provider in case of disruptions, if applicable (in point AD 2.22 'Flight Procedures'); and
5. description of the interdependencies of service availability or indication of aerodromes not suitable for diversion from the aerodrome (airspace users shall not plan an aerodrome as alternate when serviced by the same remote tower centre), if deemed applicable.

****** AD 2.24 Aeronautical charts related to an aerodrome**

Aeronautical charts related to an aerodrome shall be included in the following order:

1. Aerodrome/Heliport Chart – ICAO;
2. Aircraft Parking/Docking Chart – ICAO;
3. Aerodrome Ground Movement Chart – ICAO;
4. Aerodrome Obstacle Chart – ICAO Type A (for each runway);

5. Aerodrome Terrain and Obstacle Chart – ICAO (Electronic);
6. Precision Approach Terrain Chart – ICAO (precision approach Category II and III runways);
7. Area Chart – ICAO (departure and transit routes);
8. Standard Departure Chart – Instrument – ICAO;
9. Area Chart – ICAO (arrival and transit routes);
10. Standard Arrival Chart – Instrument – ICAO;
11. ATC Surveillance Minimum Altitude Chart – ICAO;
12. Instrument Approach Chart – ICAO (for each runway and procedure type);
13. Visual Approach Chart – ICAO; and
14. bird concentrations in the vicinity of the aerodrome.

If some of the aeronautical charts are not produced, a statement to this effect shall be given in section GEN 3.2 'Aeronautical charts'.

****** AD 2.25 Visual segment surface (VSS) penetration**

Visual segment surface (VSS) penetration, including procedure and procedure minima affected.

AD 3. HELIPORTS

Note.— **** is to be replaced by the relevant ICAO location indicator.
--

When a helicopter landing area is provided at the aerodrome, associated data shall be listed only under point **** AD 2.16.

****** AD 3.1 Heliport location indicator and name**

The ICAO location indicator assigned to the heliport and to the names of the heliport shall be included in AIP. An ICAO location indicator shall be an integral part of the referencing system applicable to all subsections in section AD 3.

****** AD 3.2 Heliport geographical and administrative data**

The requirement is for heliport geographical and administrative data, including:

1. heliport reference point (geographical coordinates in degrees, minutes and seconds) and its site;
2. direction and distance of heliport reference point from centre of the city or town that the heliport serves;
3. heliport elevation to the nearest metre or foot, and reference temperature;
4. where appropriate, geoid undulation at the heliport elevation position to the nearest metre or foot;
5. magnetic variation to the nearest degree, date of information and annual change;

6. name of heliport operator, address, telephone and telefax numbers, email address, AFS address and, if available, website address;
7. types of traffic permitted to use the heliport (IFR/VFR); and
8. remarks.

****** AD 3.3 Operational hours**

Detailed description of the hours of operation of services at the heliport, including:

1. heliport operator;
2. customs and immigration;
3. health and sanitation;
4. AIS briefing office;
5. ATS reporting office (ARO);
6. MET briefing office;
7. ATS;
8. fuelling;
9. handling;
10. security;
11. de-icing; and
12. remarks.

****** AD 3.4 Handling services and facilities**

Detailed description of the handling services and facilities available at the heliport, including:

1. cargo-handling facilities;
2. fuel and oil types;
3. fuelling facilities and capacity;
4. de-icing facilities;
5. hangar space for visiting helicopter;
6. repair facilities for visiting helicopter; and
7. remarks.

****** AD 3.5 Passenger facilities**

Passenger facilities available at the heliport, provided as a brief description or as a reference to other information sources such as a website, including:

1. hotel(s) at or in the vicinity of the heliport;
2. restaurant(s) at or in the vicinity of the heliport;
3. transportation possibilities;

4. medical facilities;
5. bank and post office at or in the vicinity of the heliport;
6. tourist office; and
7. remarks.

****** AD 3.6 Rescue and firefighting services**

Detailed description of the RFFSs and equipment available at the heliport, including:

1. heliport category for firefighting;
2. rescue equipment;
3. capability for removal of disabled helicopter; and
4. remarks.

****** AD 3.7 Seasonal availability – clearing**

Detailed description of the equipment and operational priorities established for the clearance of heliport movement areas, including:

1. type(s) of clearing equipment;
2. clearance priorities; and
3. remarks.

****** AD 3.8 Aprons, taxiways and check locations/positions data**

Details related to the physical characteristics of aprons, taxiways and locations/positions of designated checkpoints, including:

1. designation, surface and strength of aprons, helicopter stands;
2. designation, width, and surface type of helicopter ground taxiways;
3. width and designation of helicopter air taxiway and air transit route;
4. location and elevation to the nearest metre or foot of altimeter checkpoints;
5. location of VOR checkpoints;
6. position of INS checkpoints in degrees, minutes, seconds and hundredths of seconds; and
7. remarks.

If check locations/positions are presented on a heliport chart, a note to that effect shall be provided under this subsection.

****** AD 3.9 Markings and markers**

Brief description of final approach and take-off area and taxiway markings and markers, including:

1. final approach and take-off markings;
2. taxiway markings, air taxiway markers and air transit route markers; and

3. remarks.

****** AD 3.10 Heliport obstacles**

Detailed description of obstacles, including:

1. obstacle identification or designation;
2. type of obstacle;
3. obstacle position, represented by geographical coordinates in degrees, minutes, seconds and tenths of seconds;
4. obstacle elevation and height to the nearest metre or foot;
5. obstacle marking, and type and colour of obstacle lighting (if any);
6. if appropriate, an indication that the list of obstacles is available in electronic form, and a reference to point GEN 3.1.6; and
7. 'NIL' indication, if appropriate.

****** AD 3.11 Meteorological information provided**

Detailed description of meteorological information provided at the heliport and an indication of which meteorological office is responsible for the service enumerated, including:

1. name of the associated meteorological office;
2. hours of service and, where applicable, the designation of the responsible meteorological office outside these hours;
3. office responsible for preparation of TAFs, and periods of validity of the forecasts;
4. availability of the TREND forecasts for the heliport, and interval of issuance;
5. information on how briefing and/or consultation is provided;
6. type of flight documentation supplied and language(s) used in flight documentation;
7. charts and other information displayed or available for briefing or consultation;
8. supplementary equipment available for providing information on meteorological conditions, such as weather radar and receiver for satellite images;
9. the ATS unit(s) provided with meteorological information; and
10. additional information such as any limitation of service, etc.

****** AD 3.12 Heliport data**

Detailed description of heliport dimensions and related information, including:

1. heliport type – surface-level, elevated or helideck;
2. touchdown and lift-off (TLOF) area dimensions to the nearest metre or foot;
3. true bearings to one-hundredth of a degree of final approach and take-off (FATO) area;
4. dimensions to the nearest metre or foot of FATO, and surface type;
5. surface and bearing strength in tonnes (1 000 kg) of TLOF;

6. geographical coordinates in degrees, minutes, seconds and hundredths of seconds and, where appropriate, geoid undulation of the geometric centre of TLOF or of each threshold of FATO:
 - for non-precision approaches, to the nearest metre or foot; and
 - for precision approaches, to the nearest tenth of a metre or tenth of a foot;
7. TLOF and/or FATO slope and elevation:
 - for non-precision approaches, to the nearest metre or foot; and
 - for precision approaches, to the nearest tenth of a metre or tenth of a foot;
8. dimensions of safety area;
9. dimensions to the nearest metre or foot of helicopter clearway;
10. the existence of an obstacle-free sector; and
11. remarks.

****** AD 3.13 Declared distances**

Detailed description of declared distances to the nearest metre or foot, where relevant for a heliport, including:

1. take-off distance available, and if applicable, alternative reduced declared distances;
2. rejected take-off distance available;
3. landing distance available; and
4. remarks, including entry or start point where alternative reduced declared distances have been declared.

****** AD 3.14 Approach and FATO lighting**

Detailed description of approach and FATO lighting, including:

1. type, length and intensity of approach lighting system;
2. type of visual approach slope indicator system;
3. characteristics and location of FATO area lights;
4. characteristics and location of aiming point lights;
5. characteristics and location of TLOF lighting system; and
6. remarks.

****** AD 3.15 Other lighting, secondary power supply**

Description of other lighting and secondary power supply, including:

1. location, characteristics and hours of operation of heliport beacon;
2. location and lighting of wind direction indicator (WDI);
3. taxiway edge and taxiway centre line lights;
4. secondary power supply including switchover time; and

5. remarks.

****** AD 3.16 Air traffic services airspace**

Detailed description of ATS airspace organised at the heliport, including:

1. airspace designation and geographical coordinates in degrees, minutes and seconds of the lateral limits;
2. vertical limits;
3. airspace classification;
4. call sign and language(s) of ATS unit providing service;
5. transition altitude;
6. hours of applicability; and
7. remarks.

****** AD 3.17 Air traffic services communication facilities**

Detailed description of ATS communication facilities established at the heliport, including:

1. service designation;
2. call sign;
3. frequency(ies);
4. hours of operation; and
5. remarks.

****** AD 3.18 Radio navigation and landing aids**

Detailed description of radio navigation and landing aids associated with the instrument approach and the terminal area procedures at the heliport, including:

1.
 - a) type of aids;
 - b) magnetic variation to the nearest degree, as appropriate;
 - c) type of supported operation for ILS/MLS/GLS, basic GNSS and SBAS;
 - d) classification for ILS;
 - e) facility classification and approach facility designation(s) for GBAS;
 - f) for VOR/ILS/MLS, also station declination to the nearest degree used for technical line-up of the aid;
2. identification, if required;
3. frequency(ies), channel number(s), service provider and reference path identifier(s) (RPI(s)), as appropriate;
4. hours of operation, as appropriate;
5. geographical coordinates in degrees, minutes, seconds and tenths of seconds of the position of the transmitting antenna, as appropriate;

6. elevation of the DME transmitting antenna to the nearest 30 m (100 ft) and of the distance-measuring equipment precision (DME/P) to the nearest 3 m (10 ft), elevation of GBAS reference point to the nearest metre or foot, and the ellipsoid height of the point to the nearest metre or foot; for SBAS, the ellipsoid height of the landing threshold point (LTP) or the fictitious threshold point (FTP) to the nearest metre or foot;
7. service volume radius from the GBAS reference point to the nearest kilometre or nautical mile;
8. remarks.

When the same aid is used for both en-route and heliport purposes, a description shall also be given in section ENR 4. If the GBAS serves more than one heliport, a description of the aid shall be provided under each heliport. If the operating authority of the facility is other than the designated authority, the name of the operating authority shall be indicated in the remarks column. Facility coverage shall be indicated in the remarks column.

****** AD 3.19 Local heliport regulations**

Detailed description of regulations applicable to the use of the heliport, including the acceptability of training flights, non-radio and microlight aircraft and similar, and to ground manoeuvring and parking but excluding flight procedures.

****** AD 3.20 Noise abatement procedures**

Detailed description of noise abatement procedures established at the heliport.

****** AD 3.21 Flight procedures**

Detailed description of the conditions and flight procedures, including radar and/or ADS-B procedures, established on the basis of airspace organisation established at the heliport. When established, detailed description of the low visibility procedures at the heliport, including:

1. touchdown and lift-off (TLOF) area(s) and associated equipment authorised for use under low visibility procedures;
2. defined meteorological conditions under which initiation, use and termination of low visibility procedures would be made;
3. description of ground marking/lighting for use under low visibility procedures; and
4. remarks.

****** AD 3.22 Additional information**

Additional information about the heliport, such as an indication of bird concentrations at the heliport together with an indication of significant daily movement between resting and feeding areas, to the extent practicable.

****** AD 3.23 Charts related to a heliport**

Aeronautical charts related to a heliport shall be included in the following order:

1. Aerodrome/Heliport Chart – ICAO;

2. Area Chart – ICAO (departure and transit routes);
3. Standard Departure Chart – Instrument – ICAO;
4. Area Chart – ICAO (arrival and transit routes);
5. Standard Arrival Chart – Instrument – ICAO;
6. ATC Surveillance Minimum Altitude Chart – ICAO;
7. Instrument Approach Chart – ICAO (for each procedure type);
8. Visual Approach Chart – ICAO; and
9. bird concentrations in the vicinity of the heliport.

If some of the aeronautical charts are not produced, a statement to this effect shall be given in section GEN 3.2 'Aeronautical charts'.

Appendix 2

Commission Implementing Regulation (EU) 2020/469

NOTAM FORMAT

Priority Indicator												→
Address												
												≡
Date and time of filing												→
Originator's Indicator												≡(
Message Series, Number and Identifier												
NOTAM containing new informationNOTAMN (series and number/year)											
NOTAM replacing a previous NOTAMNOTAMR (series and number/year) (series and number/year of NOTAM to be replaced)											
NOTAM cancelling a previous NOTAMNOTAMC (series and number/year) (series and number/year of NOTAM to be cancelled)											≡
Qualifiers												
	FIR	NOTAM Code	Traffic	Purpose	Scope	Lower Limit	Upper Limit	Coordinates, Radius				
Q)		Q										≡
Identification of ICAO location indicator in which the facility, airspace or condition reported on is located							A) →					
Period of Validity												
From (date-time group)			B)							→		
To (PERM or date-time group)			C)							EST* PERM* ≡		
Time Schedule (if applicable)			D)							→		
										≡		
Text of NOTAM; Plain-language Entry (using ICAO Abbreviations)												
E)											≡	
Lower Limit	F)											→
Upper Limit	G)) ≡
Signature												

*Delete as appropriate

INSTRUCTIONS FOR THE COMPLETION OF THE NOTAM FORMAT**1. General**

The qualifier line (Item Q) and all identifiers (Items A to G inclusive) each followed by a closing parenthesis, as shown in the format, shall be transmitted unless there is no entry to be made against a particular identifier.

2. NOTAM numbering

Each NOTAM shall be allocated a series identified by a letter and a four-digit number followed by a stroke and a two-digit number for the year (e.g. A0023/03). Each series shall start on 1 January with the number 0001.

3. Qualifiers (Item Q)

Item Q is divided into eight fields, each separated by a stroke. An entry shall be made in each field. Examples of how fields are to be filled in are shown in the Aeronautical Information Services Manual (ICAO Doc 8126). The definition of the field is as follows:

1. FIR

- a) If the subject of the information is geographically located within one FIR, the ICAO location indicator shall be that of the FIR concerned. When an aerodrome is situated within the overlying FIR of another Member State, the first field of Item Q shall contain the code for that overlying FIR (e.g. Q) LFRR/...A) EGJJ);

or,

if the subject of the information is geographically located within more than one FIR, the FIR field shall be composed of the ICAO nationality letters of the Member State originating the NOTAM followed by 'XX'. The location indicator of the overlying UIR shall not be used. The ICAO location indicators of the FIRs concerned shall then be listed in Item A or the indicator of the Member State or the delegated entity which is responsible for provision of a navigation service in more than one Member State.

- b) If one Member State issues a NOTAM affecting FIRs in a group of Member States, the first two letters of the ICAO location indicator of the issuing Member State plus 'XX' shall be included. The location indicators of the FIRs concerned shall then be listed in Item A or the indicator of the Member State or the delegated entity which is responsible for provision of a navigation service in more than one Member State.

2. NOTAM CODE

All NOTAM Code groups contain a total of five letters, the first of which is always the letter 'Q'. The second and third letters identify the subject, and the fourth and fifth letters denote the status or condition of the subject reported upon. The two-letter codes for subjects and conditions are those contained in ICAO Doc 8400 'Procedures for Air Navigation Services – ICAO Abbreviations and Codes (PANS-ABC)'. For combinations of second and third, and fourth and fifth letters, refer to the 'NOTAM Selection Criteria' contained in ICAO Doc 8126 or insert one of the following combinations, as appropriate:

- a) if the subject is not listed in the NOTAM Code (ICAO Doc 8400) or in the NOTAM Selection Criteria (ICAO Doc 8126), insert 'XX' as the second and third letters (e.g. QXXAK); if the subject is 'XX', use 'XX' also for condition (e.g. QXXXX).

- b) if the condition of the subject is not listed in the NOTAM Code (ICAO Doc 8400) or in the NOTAM Selection Criteria (ICAO Doc 8126), insert 'XX' as the fourth and fifth letters (e.g. QFAXX);
- c) when a NOTAM containing operationally significant information is issued and when it is used to announce the existence of AIRAC AIP Amendments or Supplements, insert 'TT' as the fourth and fifth letters of the NOTAM Code;
- d) when a NOTAM is issued containing a checklist of valid NOTAM, insert 'KKKK' as the second, third, fourth and fifth letters; and
- e) the following fourth and fifth letters of the NOTAM Code shall be used in NOTAM cancellations:

AK = RESUMED NORMAL OPERATION

AL = OPERATIVE (OR RE-OPERATIVE) SUBJECT TO PREVIOUSLY PUBLISHED LIMITATIONS/CONDITIONS

AO = OPERATIONAL

CC = COMPLETED

CN = CANCELLED

HV = WORK COMPLETED

XX = PLAIN LANGUAGE

*As Q - - AO = Operational shall be used for NOTAM cancellation and NOTAM promulgating new equipment or services, use the following fourth and fifth letters
Q - - CS = Installed.*

*Q - - CN = CANCELLED shall be used to cancel planned activities, e.g. navigation warnings;
Q - - HV = WORK COMPLETED shall be used to cancel work in progress.*

3. TRAFFIC

I = IFR

V = VFR

K = NOTAM is a checklist

Depending on the NOTAM subject and content, the qualifier field TRAFFIC may contain combined qualifiers.

4. PURPOSE

N = NOTAM selected for the immediate attention of flight crew members

B = NOTAM of operational significance selected for PIB entry

O = NOTAM concerning flight operations

M = Miscellaneous NOTAM; not subject for a briefing, but available on request

K = NOTAM is a checklist

Depending on the NOTAM subject and content, the qualifier field PURPOSE may contain the combined qualifiers BO or NBO.

5. SCOPE

A = Aerodrome

E = En-route

W = Nav Warning

K = NOTAM is a checklist

Depending on the NOTAM subject and content, the qualifier field SCOPE may contain combined qualifiers.

6. and 7. LOWER/UPPER

LOWER and UPPER limits shall only be expressed in flight levels (FL) and shall express the actual vertical limits of the area of influence without the addition of buffers. In the case of navigation warnings and airspace restrictions, values entered shall be consistent with those provided under Items F and G.

If the subject does not contain specific height information, insert '000' for LOWER and '999' for UPPER as default values.

8. COORDINATES, RADIUS

The latitude and longitude accurate to one minute, as well as a three-digit distance figure giving the radius of influence in NM (e.g. 4700N01140E043). Coordinates present the approximate centre of circle whose radius encompasses the whole area of influence, and if the NOTAM affects the entire FIR/UIR or more than one FIR/UIR, enter the default value '999' for radius.

4. Item A

Insert the ICAO location indicator as contained in ICAO Doc 7910 of the aerodrome or FIR in which the facility, airspace, or condition being reported on is located. More than one FIR/UIR may be indicated, when appropriate. If there is no available ICAO location indicator, use the ICAO nationality letter as given in ICAO Doc 7910, Part 2, plus 'XX' and followed up in Item E by the name, in plain language.

If information concerns GNSS, insert the appropriate ICAO location indicator allocated for a GNSS element or the common location indicator allocated for all elements of the GNSS (except GBAS).

In the case of GNSS, the location indicator may be used when identifying a GNSS element outage such as KNMH for a GPS satellite outage.

5. Item B

For date-time group, use a ten-figure group, giving year, month, day, hours and minutes in UTC. This entry is the date-time at which the NOTAMN comes into force. In the cases of NOTAMR and NOTAMC, the date-time group is the actual date and time of the NOTAM origination. The start of a day shall be indicated by '0000'.

6. Item C

With the exception of NOTAMC, a date-time group (a ten-figure group giving year, month, day, hours and minutes in UTC) indicating duration of information shall be used unless the information is of a permanent nature in which case the abbreviation 'PERM' is inserted instead. The end of a day shall be

indicated by '2359', '2400' shall not be used. If the information on timing is uncertain, the approximate duration shall be indicated using a date-time group followed by the abbreviation 'EST'. Any NOTAM which includes an 'EST' shall be cancelled or replaced before the date-time specified in Item C.

7. Item D

If the hazard, status of operation or condition of facilities being reported on will be active in accordance with a specific time and date schedule between the dates-times indicated in Items B and C, insert such information under Item D. If Item D exceeds 200 characters, consideration shall be given to providing such information in a separate, consecutive NOTAM.

8. Item E

Use decoded NOTAM Code complemented, where necessary, by ICAO abbreviations, indicators, identifiers, designators, call signs, frequencies, figures and plain language. When NOTAM is selected for international distribution, English text shall be included for those parts expressed in plain language. This entry shall be clear and concise in order to provide a suitable PIB entry. In the case of NOTAMC, a subject reference and status message shall be included to enable accurate plausibility checks.

9. Items F and G

These items are normally applicable to navigation warnings or airspace restrictions and are usually part of the PIB entry. Insert both lower and upper height limits of activities or restrictions, clearly indicating only one reference datum and unit of measurement. The abbreviations 'GND' or 'SFC' shall be used in Item F to designate 'ground' and 'surface' respectively. The abbreviation 'UNL' shall be used in Item G to designate 'unlimited'.

Appendix 3

Regulation (EU) 2022/938

SNOWTAM FORMAT

(COM heading)	(PRIORITY INDICATOR)	(ADDRESSES)						<≡
	(DATE AND TIME OF FILING)	(ORIGINATOR'S (INDICATOR))						<≡
(Abbreviated heading)	(SWAA* NUMBER)	SERIAL	(LOCATION INDICATOR)	DATE-TIME OF ASSESSMENT			(OPTIONAL GROUP)	
	S W * *						<≡(
SNOWTAM →	(Serial number)	<≡						
Aeroplane performance calculation section								
(AERODROME LOCATION INDICATOR)	M	A)						<≡
(DATE/TIME OF ASSESSMENT <i>(Time of completion of assessment in UTC)</i>)	M	B)						→
(LOWER RUNWAY DESIGNATION NUMBER)	M	C)						→
(RUNWAY CONDITION CODE (RWYCC) ON EACH RUNWAY THIRD) (From Runway Condition Assessment Matrix (RCAM) 0, 1, 2, 3, 4, 5 or 6)	M	D)	/ /					→
(PER CENT COVERAGE CONTAMINANT FOR EACH RUNWAY THIRD)	C	E)	/ /					→
DEPTH (mm) OF LOOSE CONTAMINANT FOR EACH RUNWAY THIRD	C	F)	/ /					→
(CONDITION DESCRIPTION OVER TOTAL RUNWAY LENGTH (Observed on each runway third, starting from threshold having the lower runway designation number)	M	G)	/ /					
COMPACTED SNOW DRY DRY SNOW DRY SNOW ON TOP OF COMPACTED SNOW								

DRY SNOW ON TOP OF ICE FROST ICE SLIPPERY WET SLUSH SPECIALLY PREPARED WINTER RUNWAY STANDING WATER WATER ON TOP OF COMPACTED SNOW WET WET ICE WET SNOW WET SNOW ON TOP OF COMPACTED SNOW WET SNOW ON TOP OF ICE			→
(WIDTH OF RUNWAY TO WHICH THE RUNWAY CONDITIONS CODES APPLY, IF LESS THAN PUBLISHED WIDTH)	O	H)	←≡
Situational awareness section			
(REDUCED RUNWAY LENGTH, IF LESS THAN PUBLISHED LENGTH (m))	O	I)	→
(DRIFTING SNOW ON THE RUNWAY)	O	J)	→
(LOOSE SAND ON THE RUNWAY)	O	K)	→
(CHEMICAL TREATMENT ON RUNWAY)	O	L)	→
(SNOWBANKS ON THE RUNWAY (If present, distance from runway centre line (m) followed by 'L', 'R' or 'LR' as applicable))	O	M)	→
(SNOWBANKS ON A TAXIWAY)	O	N)	→
(SNOWBANKS ADJACENT TO THE RUNWAY)	O	O)	→
(TAXIWAY CONDITIONS)	O	P)	→
(APRON CONDITIONS)	O	R	→

)	
(MEASURED FRICTION COEFFICIENT)	O	S)	→
(PLAIN-LANGUAGE REMARKS)	O	T)) <<≡
NOTES: 1. *Enter ICAO nationality letters as given in ICAO Doc 7910, Part 2, or otherwise applicable aerodrome identifier. 2. Information on other runways, repeat from B to H. 3. Information in the situational awareness section repeated for each runway, taxiway and apron. Repeat as applicable, when reported. 4. Words in brackets () not to be transmitted. 5. For letters A) to T) refer to the <i>Instructions for the completion of the SNOWTAM format, paragraph 1, item b)</i> .			

 SIGNATURE OF ORIGINATOR (*not for transmission*)

INSTRUCTIONS FOR THE COMPLETION OF THE SNOWTAM FORMAT
1. General

- (a) When reporting on more than one runway, repeat Items B to H (aeroplane performance calculation section).
- (b) The letters used to indicate items are only used for reference purpose and shall not be included in the messages. The letters, M (mandatory), C (conditional) and O (optional) mark the usage and information and shall be included as explained below.
- (c) Metric units shall be used and the unit of measurement shall not be reported.
- (d) The maximum validity of SNOWTAM is 8 hours. New SNOWTAM shall be issued whenever a new runway condition report is received.
- (e) A SNOWTAM cancels the previous SNOWTAM.
- (f) The abbreviated heading 'TTAAiiii CCCC MMYGGgg (BBB)' is included to facilitate the automatic processing of SNOWTAM messages in computer databanks. The explanation of these symbols is:

TT = data designator for SNOWTAM = SW;

AA = geographical designator for Member States, e.g. LF = FRANCE;

iiii = SNOWTAM serial number in a four-digit group;

CCCC = four-letter location indicator of the aerodrome to which the SNOWTAM refers;

MMYGGgg = date/time of observation/measurement, whereby:

MM = month, e.g. January = 01, December = 12;

YY = day of the month;

GGgg = time in hours (GG) and minutes (gg) UTC;

(BBB) = optional group for:

Correction, in the case of an error, to a SNOWTAM message previously disseminated with the same serial number = COR. *Brackets in (BBB) shall be used to indicate that this group is optional. When reporting on more than one runway and individual dates/times of observation/assessment are indicated by repeated Item B, the latest date/time of observation/assessment shall be inserted in the abbreviated heading (MMYYGGgg).*

- (g) The text 'SNOWTAM' in the SNOWTAM Format and the SNOWTAM serial number in a four-digit group shall be separated by a space, e.g. SNOWTAM 0124.
- (h) For readability purposes for the SNOWTAM message, a linefeed shall be included after the SNOWTAM serial number, after Item A, and after the aeroplane performance calculation section.
- (i) When reporting on more than one runway, repeat the information in the aeroplane performance calculation section from the date and time of assessment for each runway before the information in the situational awareness section.
- (j) Mandatory information is:
 - 1) AERODROME LOCATION INDICATOR;
 - 2) DATE AND TIME OF ASSESSMENT;
 - 3) LOWER RUNWAY DESIGNATOR NUMBER;
 - 4) RUNWAY CONDITION CODE FOR EACH RUNWAY THIRD; and
 - 5) CONDITION DESCRIPTION FOR EACH RUNWAY THIRD (when runway condition code (RWYCC) is reported 0–6)

2. Aeroplane performance calculation section

Item A — Aerodrome location indicator (four-letter location indicator).

Item B — Date and time of assessment (eight-figure date/time group giving time of observation as month, day, hour and minute in UTC).

Item C — Lower runway designator number (nn[L] or nn[C] or nn[R]).

Only one runway designator shall be inserted for each runway and always the lower number.

Item D — Runway condition code for each runway third. Only one digit (0, 1, 2, 3, 4, 5 or 6) is inserted for each runway third, separated by an oblique stroke (n/n/n).

Item E — Per cent coverage for each runway third. When provided, insert 25, 50, 75 or 100 for each runway third, separated by an oblique stroke ([n]nn/[n]nn/[n]nn).

This information shall be provided only when there is a condition description for each runway third (Item G) that has been reported other than 'DRY'.

When the conditions are not reported, this shall be signified by the insertion of 'NR' for the appropriate runway third(s).

Item F — Depth of loose contaminant for each runway third. When provided, insert in millimetres for each runway third, separated by an oblique stroke (nn/nn/nn or nnn/nnn/nnn).

This information shall only be provided for the following contamination types:

- standing water, values to be reported 04, then assessed value. Significant changes 3 mm;
- slush, values to be reported 03, then assessed value. Significant changes 3 mm;
- wet snow, values to be reported 03, then assessed value. Significant changes 5 mm; and
- dry snow, values to be reported 03, then assessed value. Significant changes 20 mm.

When the conditions are not reported, this shall be signified by the insertion of 'NR' for the appropriate runway third(s).

Item G — Condition description for each runway third. Any of the following condition descriptions for each runway third, separated by an oblique stroke, shall be inserted.

COMPACTED SNOW

DRY SNOW

DRY SNOW ON TOP OF COMPACTED SNOW

DRY SNOW ON TOP OF ICE

FROST

ICE

SLIPPERY WET

SLUSH

SPECIALLY PREPARED WINTER RUNWAY

STANDING WATER

WATER ON TOP OF COMPACTED SNOW

WET

WET ICE

WET SNOW

WET SNOW ON TOP OF COMPACTED SNOW

WET SNOW ON TOP OF ICE

DRY (only reported when there is no contaminant)

When the conditions are not reported, this shall be signified by the insertion of 'NR' for the appropriate runway third(s).

Item H — Width of runway to which the runway condition codes apply. The width in metres, if less than the published runway width, shall be inserted.

3. Situational awareness section

Elements in the situational awareness section shall end with a full stop.

Elements in the situational awareness section for which no information exists, or where the conditional circumstances for publication are not fulfilled, shall be left out completely.

- Item I — Reduced runway length. The applicable runway designator and available length in metres shall be inserted (e.g. RWY nn [L] or nn [C] or nn [R] REDUCED TO [n]nnn).
This information is conditional when a NOTAM has been published with a new set of declared distances.
- Item J — Drifting snow on the runway. When reported, 'DRIFTING SNOW' shall be inserted with a space 'DRIFTING SNOW' (RWY nn or RWY nn[L] or nn[C] or nn[R] DRIFTING SNOW).
- Item K — Loose sand on the runway. When loose sand is reported on the runway, the lower runway designator shall be inserted with a space 'LOOSE SAND' (RWY nn or RWY nn[L] or nn[C] or nn[R] LOOSE SAND).
- Item L — Chemical treatment on the runway. When chemical treatment has been reported applied, the lower runway designator shall be inserted with a space 'CHEMICALLY TREATED' (RWY nn or RWY nn[L] or nn[C] or nn[R] CHEMICALLY TREATED).
- Item M — Snowbanks on the runway. When snowbanks are reported present on the runway, the lower runway designator shall be inserted with a space 'SNOWBANK' and with a space left 'L' or right 'R' or both sides 'LR', followed by the distance in metres from centre line separated by a space 'FM CL' (RWY nn or RWY nn[L] or nn[C] or nn[R] SNOWBANK Lnn or Rnn or LRnn FM CL).
- Item N — Snowbanks on a taxiway. When snowbanks are present on taxiway(s), the taxiway(s) designator(s) shall be inserted with a space 'SNOWBANKS' (TWY [nn]n or TWYS [nn]n/[nn]n/[nn]n... or ALL TWYS SNOWBANKS).
- Item O — Snowbanks adjacent to the runway. When snowbanks are reported present, penetrating the height profile in the aerodrome snow plan, the lower runway designator and 'ADJ SNOWBANKS' shall be inserted (RWY nn or RWY nn[L] or nn[C] or nn[R] ADJ SNOWBANKS).
- Item P — Taxiway conditions. When taxiway conditions are reported slippery or poor, the taxiway designator followed by a space 'POOR' shall be inserted (TWY [n or nn] POOR or TWYS [n or nn]/[n or nn]/[n or nn] POOR... or ALL TWYS POOR).
- Item R — Apron conditions. When apron conditions are reported slippery or poor, the apron designator followed by a space 'POOR' shall be inserted (APRON [nnnn] POOR or APRONS [nnnn]/[nnnn]/[nnnn] POOR or ALL APRONS POOR).
- Item S — (NR) Not reported.
- Item T — Plain-language remarks.

Appendix 4

Regulation (EU) 2020/469

ASHTAM FORMAT

(COM heading)	(PRIORITY INDICATOR)	(ADDRESSEE INDICATOR(S)) ¹																			
	(DATE AND TIME OF FILING)						(ORIGINATOR'S INDICATOR)														
(Abbreviated heading)	(VA* ² SERIAL NUMBER)						(LOCATION INDICATOR)			DATE/TIME OF ISSUANCE						(OPTIONAL GROUP)					
	V	A	*2	*2																	

ASHTAM	(SERIAL NUMBER)
{FLIGHT INFORMATION REGION AFFECTED}	A)
{DATE/TIME (UTC) OF ERUPTION}	B)
{VOLCANO NAME AND NUMBER}	C)
{VOLCANO LATITUDE/LONGITUDE OR VOLCANO RADIAL AND DISTANCE FROM NAVAID}	D)
{VOLCANO LEVEL OF ALERT COLOUR CODE, INCLUDING ANY PRIOR LEVEL OF ALERT COLOUR CODE} ³	E)
{EXISTENCE AND HORIZONTAL/VERTICAL EXTENT OF VOLCANIC ASH CLOUD} ⁴	F)
{DIRECTION OF MOVEMENT OF ASH CLOUD} ⁴	G)
{AIR ROUTES OR PORTIONS OF AIR ROUTES AND FLIGHT LEVELS AFFECTED}	H)
{CLOSURE OF AIRSPACE AND/OR AIR ROUTES OR PORTIONS OF AIR ROUTES, AND ALTERNATIVE AIR ROUTES AVAILABLE}	I)
{SOURCE OF INFORMATION}	J)
{PLAIN-LANGUAGE REMARKS}	K)
<p>NOTES:</p> <ol style="list-style-type: none"> See also AIS.TR.400 regarding addressee indicators used in predetermined distribution systems. *Enter ICAO nationality letter as given in ICAO Doc 7910, Part 2. See paragraph 3.5 below. Advice on the existence, extent and movement of volcanic ash cloud G) and H) may be obtained from the volcanic ash advisory centre(s) responsible for the FIR concerned. Item titles in brackets () not to be transmitted. 	

 SIGNATURE OF ORIGINATOR *(not for transmission)*

INSTRUCTIONS FOR THE COMPLETION OF THE ASHTAM FORMAT**1. General**

- 1.1 The ASHTAM provides information on the status of activity of a volcano when a change in its activity is, or is expected to be of operational significance. This information is provided using the volcano level of alert colour code given in 3.5 below.
- 1.2 In the event of a volcanic eruption producing ash cloud of operational significance, the ASHTAM also provides information on the location, extent and movement of the ash cloud and the air routes and flight levels affected.
- 1.3 Issuance of an ASHTAM giving information on a volcanic eruption, in accordance with section 3 below, shall not be delayed until complete information A to K is available but shall be issued immediately following receipt of notification that an eruption has occurred or is expected to occur, or a change in the status of activity of a volcano of operational significance has occurred or is expected to occur, or an ash cloud is reported. In the case of an expected eruption, and hence no ash cloud evident at that time, items A to E shall be completed and items F to I indicated as 'not applicable'. Similarly, if a volcanic ash cloud is reported, e.g. by special air-report, but the source volcano is not known at that time, the ASHTAM shall be issued initially with items A to E indicated as 'unknown', and items F to K completed, as necessary, based on the special air-report, pending receipt of further information. In other circumstances, if information for a specific field A to K is not available indicate 'NIL'.
- 1.4 The maximum period of validity of ASHTAM is 24 hours a day. New ASHTAM shall be issued whenever there is a change in the level of alert.

2. Abbreviated heading

- 2.1 Following the usual 'Aeronautical fixed – telecommunications network (AFTN)' communications header, the abbreviated heading 'TT AAiiii CCCC MMYGGgg (BBB)' shall be included to facilitate the automatic processing of ASHTAM messages in computer databanks. The explanation of these symbols is:

TT =	data designator for ASHTAM = VA;
AA =	geographical designator for States, e.g. NZ = New Zealand;
iiii =	ASHTAM serial number in a four-figure group;
CCCC =	four-letter location indicator of the flight information region concerned;
MMYYGGgg =	date/time of report, whereby:
MM =	month, e.g. January = 01, December = 12;
YY =	day of the month;
GGgg =	time in hours (GG) and minutes (gg) UTC;
(BBB) =	Optional group for correction to an ASHTAM message previously disseminated with the same serial number = COR.

Brackets in (BBB) shall be used to indicate that this group is optional.

3. Content of ASHTAM

- 3.1 *Item A* – Flight information region affected, plain-language equivalent of the location indicator given in the abbreviated heading, in this example: ‘Auckland Oceanic FIR’.
- 3.2 *Item B* – Date and time (UTC) of first eruption.
- 3.3 *Item C* – Name of volcano, and number of volcano as listed in ICAO Doc 9691 *Manual on Volcanic Ash, Radioactive Material and Toxic Chemical Clouds*, Appendix H, and on the World Map of Volcanoes and Principal Aeronautical Features.
- 3.4 *Item D* – Latitude/Longitude of the volcano in whole degrees or radial and distance of volcano from NAVAID, as listed in the ICAO Doc 9691 *Manual on Volcanic Ash, Radioactive Material and Toxic Chemical Clouds*, Appendix H, and on the World Map of Volcanoes and Principal Aeronautical Features.
- 3.5 *Item E* – Colour code for level of alert indicating volcanic activity, including any previous level of alert colour code as follows:

Level of alert colour code	Status of activity of volcano
GREEN ALERT	Volcano is in normal, non-eruptive state. or, after a change from a higher alert level: Volcanic activity considered to have ceased, and volcano reverted to its normal, non-eruptive state.
YELLOW ALERT	Volcano is experiencing signs of elevated unrest above known background levels. or, after a change from higher alert level: Volcanic activity has decreased significantly but continues to be closely monitored for possible renewed increase.
ORANGE ALERT	Volcano is exhibiting heightened unrest with increased likelihood of eruption. or, Volcanic eruption is underway with no or minor ash emission [specify ash-plume height, if possible].
RED ALERT	Eruption is forecasted to be imminent with significant emission of ash into the atmosphere likely. or, Eruption is underway with significant emission of ash into the atmosphere [specify ash-plume height, if possible].

The colour code for the level of alert indicating the status of activity of the volcano and any change from a previous status of activity shall be provided to the area control centre by the responsible vulcanological agency in the Member State concerned, e.g. ‘RED ALERT FOLLOWING YELLOW’ OR ‘GREEN ALERT FOLLOWING ORANGE’.

- 3.6 *Item F* – If volcanic ash cloud of operational significance is reported, the horizontal extent and base/top of the ash cloud shall be indicated using latitude/longitude (in whole degrees) and altitudes in thousands of metres (feet) and/or radial and distance from source volcano.

Information initially may be based only on special air-report, but subsequent information may be more detailed based on advice from the responsible meteorological watch office and/or volcanic ash advisory centre.

- 3.7 *Item G* – Forecast direction of movement of the ash cloud at selected levels shall be indicated based on advice from the responsible meteorological watch office and/or volcanic ash advisory centre.
- 3.8 *Item H* – Air routes and portions of air routes and flight levels affected, or expected to become affected, shall be indicated.
- 3.9 *Item I* – Closure of airspace, air routes or portions of air routes, and availability of alternative routes, shall be indicated.
- 3.10 *Item J* – Source of the information, e.g. ‘special air-report’ or ‘vulcanological agency’, etc. The source of information shall always be indicated, whether an eruption has actually occurred or ash cloud reported, or not.
- 3.11 *Item K* – Any operationally significant information, additional to the foregoing, shall be included in plain language.

ANNEX VII — PART-DAT

SPECIFIC REQUIREMENTS FOR PROVIDERS OF DATA SERVICES

SUBPART A — ADDITIONAL ORGANISATION REQUIREMENTS FOR PROVIDERS OF DATA SERVICES (DAT.OR)

SECTION 1 — GENERAL REQUIREMENTS

DAT.OR.100 Aeronautical data and information

Regulation (EU) 2017/373

- (a) The DAT provider shall receive, assemble, translate, select, format, distribute and/or integrate aeronautical data and information that is released by an authoritative source for use in aeronautical databases on certified aircraft application/equipment.

In specific cases, if aeronautical data is not provided in the aeronautical information publication (AIP) or by an authoritative source or does not meet the applicable data quality requirements (DQRs), that aeronautical data may be originated by the DAT provider itself and/or by other DAT providers. In this context, that aeronautical data shall be validated by the DAT provider originating it.

- (b) When so requested by its customers, the DAT provider may process tailored data provided by the aircraft operator or originating from other DAT providers for use by that aircraft operator. The responsibility for this data and its subsequent update shall remain with the aircraft operator.

AMC1 DAT.OR.100 Aeronautical data and information

ED Decision 2017/001/R

GENERAL

- (a) Aeronautical data and information in this context should consist of:
- (1) Integrated Aeronautical Information Package (IAIP); and/or
 - (2) obstacle data; and/or
 - (3) terrain data; and/or
 - (4) Aerodrome Mapping Data (AMD); and/or
 - (5) other data and information that is validated by the DAT provider for the purpose of provision of its services.
- (b) Aeronautical databases should be databases, used on certified aircraft application/equipment, that support the flight operation where incorrect data leads to failures having at least minor or higher failure effect.

- (c) The scope should not include databases that are approved as part of the type design of the aircraft or engine (e.g. engine power settings (take-off, climb, maximum continuous thrust (MCT), cruise) and aircraft performance data (e.g. take-off distance, V speeds)).

GM1 DAT.OR.100 Aeronautical data and information

ED Decision 2017/001/R

GENERAL

- (a) In the context of this Regulation, aeronautical databases should include databases, used on certified aircraft applications, that support the flight operation of aircraft for the purpose of primary communication, navigation and surveillance (CNS) or supplementing CNS.
- (1) Database used in primary CNS applications (e.g. flight management system (FMS)).
 - (2) Database used in supplementary CNS applications including but not limited to systems generating alerts and used for awareness having the following databases:
 - (i) database for synthetic vision systems;
 - (ii) terrain database (TAWS);
 - (iii) obstacle database (TAWS);
 - (iv) aerodrome mapping database (AMDB);
 - (v) brake assistance to vacate; and
 - (vi) surface indication and alert system.
- (b) Databases for which the DAT provider is not required to be certified in accordance with this Regulation include but are not limited to:
- (1) databases provided and/or used by the operator of the aircraft that are monitored under the operator's responsibility and not loaded into certified aircraft applications (e.g. airport moving map used in electronic flight bags (EFBs), take-off and landing performance used in EFBs);
 - (2) databases not having any safety affect (e.g. used for passenger in-flight entertainment (IFE) systems outside the flight deck, etc.); and
 - (3) databases for systems applications/equipment installed on aircraft certified for visual flight rules (VFR) operation only, except those used for primary navigation to meet the airspace usage requirements.

AMC1 DAT.OR.100(a) Aeronautical data and information

ED Decision 2017/001/R

DATA SOURCE

The DAT provider should use data coming from authoritative sources. If such data is not formally made available by an authoritative source or does not meet the applicable data quality requirements, but is required by end users, the DAT provider may use data from other (non-authoritative) sources, provided these have been verified and validated by the DAT provider itself and/or other DAT providers to conform with the relevant standards and data quality requirements.

If a non-authoritative source is used for the data release, the DAT provider should issue a statement at its discretion.

GM1 to AMC1 DAT.OR.100(a) Aeronautical data and information

ED Decision 2017/001/R

NON-AUTHORITATIVE SOURCE

- (a) A non-authoritative source may be an organisation other than those defined in point 32 of Annex I, but providing and/or publishing data derived from data gathering or measuring performed (e.g. by aircraft operators, air crew, DAT providers, or other similar operational organisations, or a combination thereof), transformation of various sources to provide aeronautical data which conform with relevant standards and data quality requirements as specified by the airspace end users.
- (b) When validating data from a non-authoritative source, the DAT provider should proceed by using either additional information sources to validate this data (like satellite imagery, data or manuals from other providers, users, military, etc.), or data which has been tested and confirmed through operations.

GM2 to AMC1 DAT.OR.100(a) Aeronautical data and information

ED Decision 2017/001/R

DATA SOURCE

The first known DAT provider that uses data coming from other (non-authoritative) sources in the aeronautical data chain, accepts the responsibility of the data originator (i.e. ensuring that the data meets the data quality requirements).

GM3 to AMC1 DAT.OR.100(a) Aeronautical data and information

ED Decision 2017/001/R

END USER

In the context of this Regulation, the end users should be considered the 'airspace users' as defined in Article 2(8) of [Regulation \(EC\) No 549/2004](#).

GM1 DAT.OR.100(a) Aeronautical data and information

ED Decision 2017/001/R

VALIDATION OF AERONAUTICAL DATA

The processes of validating the aeronautical data by DAT provider should meet the standards specified in EUROCAE ED-76A/RTCA DO-200B 'Standards for Processing Aeronautical Data', dated June 2015, especially Section 2.4.1 (6) and Appendix C, in particular points C.2.1 and C.2.2. EUROCAE ED-76/RTCA DO-200A may be also used for the demonstration of compliance.

GM1 DAT.OR.100(b) Aeronautical data and information

ED Decision 2017/001/R

GENERAL

- (a) The full responsibility for the origination and provision of tailored data and its subsequent updates, as required, should lie with the aircraft operator.

- (b) The origination and provision of tailored data by an aircraft operator or on the aircraft operator's behalf for the purpose of air operation is not part of the DAT provider's scope of activities and this Regulation does not cover its oversight.
- (c) The use of tailored data is related and limited to the operational purposes of the aircraft operator that requested the insertion of the tailored data.

DAT.OR.105 Technical and operational competence and capability

Regulation (EU) 2017/373

- (a) In addition to [ATM/ANS.OR.B.001](#), the DAT provider shall:
 - (1) perform the reception, assembly, translation, selection, formatting, distribution and/or integration of aeronautical data and information that is released by aeronautical data source provider(s) into aeronautical databases for certified aircraft application/equipment under the applicable requirements. The type 2 DAT provider shall ensure that the DQRs are compatible with the intended use of the certified aircraft application/equipment through an appropriate arrangement with the specific equipment design approval holder or an applicant for an approval of that specific design;
 - (2) issue a statement of conformity that the aeronautical databases it has produced are produced in accordance with this Regulation and the applicable industry standards;
 - (3) provide assistance to the equipment design approval holder in dealing with any continuing airworthiness actions that are related to the aeronautical databases that have been produced.
- (b) For release of databases, the accountable manager shall nominate attesting staff identified in point [DAT.TR.100\(b\)](#) and allocate their responsibilities in an independent manner to attest through the statement of conformity that data meets the DQRs and processes are followed. The ultimate responsibility for the databases release statements signed by the attesting staff shall remain with the accountable manager of the DAT provider.

GM1 DAT.OR.105(a)(1) Technical and operational competence and capability

ED Decision 2017/001/R

AERONAUTICAL DATA SOURCE PROVIDER

Aeronautical data source providers should be considered at least, but are not limited to:

- (a) organisations providing authoritative data for the purpose of air navigation (e.g. AIS providers);
- (b) the DAT provider itself or another DAT provider;
- (c) the aircraft operator(s) for tailored data; and
- (d) the aerodrome operator(s), in case the information is not provided in the AIPs.

GM2 DAT.OR.105(a)(1) Technical and operational competence and capability

ED Decision 2017/001/R

DQR COMPATIBILITY

The Type 2 DAT provider should ensure through an appropriate arrangement that the equipment design approval holder or an applicant for an approval of that specific design is responsible for demonstrating (e.g. using system verification tests, sampling checks, etc.) that the DQRs are consistent with the intended function of the equipment.

AMC1 DAT.OR.105(a)(2) Technical and operational competence and capability

ED Decision 2017/001/R

STATEMENT OF CONFORMITY FOR AERONAUTICAL DATABASES

Logo of the DAT provider	Statement of conformity for aeronautical databases	
1. DAT provider certificate number:	No	
2. Type 1/Type 2* DAT provider: <i>* delete as appropriate</i>	Name	
3. Address:	Address	
4. Database identification:	Identification	
5. Database use:	Applications/standards	
6. Deviations:	Deviations	
7. New database release:	8. Additional database release (correction):	
9. Declaration of conformity: [XXX] databases released and distributed are produced in compliance with Regulation (EU) 2017/373		
10. Attesting staff:		
Date:	Name: Name	Signature: Signature
AIRAC cycle/ validity period:		

Information to be entered into the statement of conformity for DAT form:

Field 4: List all the identifications of the databases covered under this release, or make reference to the document listing all the identifications of the released databases.

Field 5:

In case of Type 1 DAT provider, list the standard data formats.

In case of Type 2 DAT provider, list the equipment models and part numbers where compatibility has been demonstrated, or make reference to the document containing equipment models and part numbers where compatibility has been demonstrated.

Field 6: List the deviations or make reference to where the deviation information can be found (e.g. a weblink).

Field 10: Signature of an authorised representative of the applicant.

AMC2 DAT.OR.105(a)(2) Technical and operational competence and capability

ED Decision 2017/001/R

PRODUCING AND UPDATING AERONAUTICAL DATABASES

The processes of producing and updating aeronautical databases should meet the standards specified in EUROCAE ED-76A/RTCA DO-200B 'Standards for Processing Aeronautical Data', dated June 2015. EUROCAE ED-76/RTCA DO-200A may be also used for the demonstration of compliance.

GM1 DAT.OR.105(b) Technical and operational competence and capability

ED Decision 2017/001/R

INDEPENDENCE

A DAT provider should ensure that the attesting staff and the person involved in the database release is not a single person (i.e. the four-eye principle).

DAT.OR.110 Management system

Regulation (EU) 2017/373

In addition to point [ATM/ANS.OR.B.005](#), the DAT provider, as applicable for the type of DAT provision, shall establish and maintain a management system that includes control procedures for:

- (a) document issue, approval or change;
- (b) DQRs change;
- (c) verification that incoming data has been produced in accordance with the applicable standards;
- (d) timely update of the data used;
- (e) identification and traceability;
- (f) processes for reception, assembly, translation, selection, formatting, distribution and/or integration of data into a generic database or database compatible with the specific aircraft application/equipment;
- (g) data verification and validation techniques;
- (h) identification of tools, including configuration management and tools qualification, as necessary;
- (i) handling of errors/deficiencies;

- (j) coordination with the aeronautical data source provider(s) and/or DAT provider(s), and with the equipment design approval holder or an applicant for an approval of that specific design when providing type 2 DAT services;
- (k) issue of statement of conformity;
- (l) controlled distribution of databases to users.

AMC1 DAT.OR.110 Management system

ED Decision 2017/001/R

ISO 9001/EN 9100 CERTIFICATE(S) FOR TYPE 1 DAT PROVIDERS

In reference to ISO 9001/EN 9100 certificates issued by appropriate accredited organisations, please refer to [AMC1 ATM/ANS.OR.B.005\(a\)](#) 'Management system' ISO 9001/EN 9100 CERTIFICATE(S) FOR TYPE 1 DAT PROVIDERS.

AMC2 DAT.OR.110 Management system

ED Decision 2017/001/R

EN 9100 CERTIFICATE FOR TYPE 2 DAT PROVIDERS

In reference to EN 9100 certificate issued by appropriate accredited organisations, please refer to [AMC1 ATM/ANS.OR.B.005\(a\)](#) 'Management system' EN 9100 CERTIFICATE FOR TYPE 2 DAT PROVIDERS.

AMC1 DAT.OR.110(h) Management system

ED Decision 2017/001/R

TOOLS QUALIFICATION

Tools qualification should meet the standards specified in EUROCAE ED-76A/RTCA DO-200B 'Standards for Processing Aeronautical Data', dated June 2015. EUROCAE ED-76/RTCA DO-200A may be also used for the demonstration of compliance.

DAT.OR.115 Record-keeping

Regulation (EU) 2017/373

In addition to [ATM/ANS.OR.B.030](#), the DAT provider shall include in its record-keeping system the elements indicated in [DAT.OR.110](#).

SECTION 2 — SPECIFIC REQUIREMENTS

DAT.OR.200 Reporting requirements

Regulation (EU) 2017/373

- (a) The DAT provider shall:
- (1) report to the customer and, where applicable, the equipment design approval holder all the cases where aeronautical databases have been released by the DAT provider and have been subsequently identified to have deficiencies and/or errors, thus not meeting the applicable data requirements;
 - (2) report to the competent authority the deficiencies and/or errors identified according to point (1), which could lead to an unsafe condition. Such reports shall be made in a form and manner acceptable to the competent authority;
 - (3) where the certified DAT provider is acting as a supplier to another DAT provider, report also to that other organisation all the cases where it has released aeronautical databases to that organisation and have been subsequently identified to have errors;
 - (4) report to the aeronautical data source provider instances of erroneous, inconsistent or missing data in the aeronautical source.
- (b) The DAT provider shall establish and maintain an internal reporting system in the interest of safety to enable the collection and assessment of reports in order to identify adverse trends or to address deficiencies, and to extract reportable events and actions.

This internal reporting system may be integrated into the management system as required in point [ATM/ANS.OR.B.005](#).

GM1 DAT.OR.200 Reporting requirements

ED Decision 2017/001/R

GENERAL

The DAT provider should notify the competent authority of the following by using the occurrence reporting form:

- (a) errors/deficiencies affecting safe operations in an airspace segment/block;
- (b) errors/deficiencies with negative impact on safety stemming from a source in a Member State or a functional airspace block (FAB); and
- (c) errors/deficiencies with negative impact on safety stemming from erroneous processing of the data or information within the intended aircraft application/equipment.

GM1 DAT.OR.200(b) Reporting requirements

ED Decision 2017/001/R

UNSAFE CONDITION

‘Unsafe condition’ may be considered as a situation where due to a data error there will be, but is not limited to:

- aircraft deviation from the published procedure;
- erroneous warning (red colour) in the cockpit (e.g. PULL UP, TERRAIN, RWY TOO SHORT);
- pilot workload increase due to presentation of misleading or conflicting data in the primary flight display; and
- malfunction or defect of an indication system at a critical phase of the flight, etc.

SUBPART B — TECHNICAL REQUIREMENTS FOR PROVIDERS OF DATA SERVICES (DAT.TR)

SECTION 1 — GENERAL REQUIREMENTS

DAT.TR.100 Working methods and operating procedures

Regulation (EU) 2017/373

The DAT provider shall:

- (a) with regard to all the necessary aeronautical data:
 - (1) establish DQRs that are agreed upon with the other DAT provider and in the case of a type 2 DAT provider, with the equipment design approval holder or an applicant for an approval of that specific design, to determine the compatibility of these DQRs with the intended use;
 - (2) use data from an authoritative source(s) and, if required, other aeronautical data verified and validated by the DAT provider itself and/or by other DAT provider(s);
 - (3) establish a procedure to ensure that the data is correctly processed;
 - (4) establish and implement processes to ensure that the tailored data provided or requested by an aircraft operator or other DAT provider shall only be distributed to the requester itself; and
- (b) with regard to attesting staff that sign the statements of conformity issued under [DAT.OR.105\(b\)](#) ensure that:
 - (1) the knowledge, background (including other functions in the organisation), and experience of the attesting staff are appropriate to their allocated responsibilities;
 - (2) it maintains records of all attesting staff which include details of the scope of their authorisation;
 - (3) attesting staff are provided with evidence of the scope of their authorisation.

AMC1 DAT.TR.100(a)(1) Working methods and operating procedures

ED Decision 2017/001/R

COMPATIBILITY WITH CERTIFIED AIRCRAFT APPLICATION/EQUIPMENT — TYPE 2 DAT PROVIDER

A Type 2 DAT provider should perform tests to ensure that the database works as intended with the application by performing sampling checks on individual data sets (e.g. in a simulation/test bench environment).

AMC1 DAT.TR.100(a)(2) Working methods and operating procedures

ED Decision 2017/001/R

DATA SOURCE

In reference to the 'data source', please refer to [AMC1 DAT.OR.100\(a\)](#) 'Aeronautical data and information'.

GM1 DAT.TR.100(a)(2) Working methods and operating procedures

ED Decision 2017/001/R

DATA EXCHANGE

To support data integrity, the DAT provider may use digital data sets as a preferred means of data exchange.

AMC1 DAT.TR.100(a)(3) Working methods and operating procedures

ED Decision 2017/001/R

DATA PROCESSING

The DAT provider should keep the records for a period of at least 3 years after the end of the validity period of the database unless otherwise specified by other applicable requirements.

GM1 DAT.TR.100(b) Working methods and operating procedures

ED Decision 2017/001/R

SIGNATURE

The attesting staff, authorised by the DAT provider, may sign the statements issued in accordance with [DAT.OR.105\(b\)](#) manually or in a digital manner (e.g. digital signature).

AMC1 DAT.TR.100(b)(1) Working methods and operating procedures

ED Decision 2017/001/R

ATTESTING STAFF

- (a) To qualify as attesting staff, appropriate knowledge, background, experience and specific training or assessment established by the DAT provider should be required.
- (b) Training should be provided to develop a satisfactory level of knowledge of organisational procedures, processes and products, aviation law, and associated IRs, AMC and GM, relevant to the particular role.
- (c) In addition to the general training policy, the DAT provider should define its own standards for training, including qualification standards, for personnel to be identified as attesting staff.
- (d) The training should be updated in response to experience gained and technological advancements.

AMC1 DAT.TR.100(b)(2) Working methods and operating procedures

ED Decision 2017/001/R

RECORDS OF ATTESTING STAFF

- (a) The following is the minimum information that should be recorded by the DAT provider in respect of each attesting staff member:
- (1) name;
 - (2) general training and standard attained;
 - (3) specific training and standard attained;
 - (4) continuation training, if appropriate;
 - (5) background experience;
 - (6) scope of the authorisation; and
 - (7) date of first issue of the authorisation.
- (b) The record should be kept in an appropriate format and should be controlled through an internal procedure of the organisation. This procedure could be part of the management system.
- (c) The DAT provider should ensure that the number of persons authorised to access the system of personnel data record-keeping is limited and an appropriate access control mechanism is in place.
- (d) The attesting staff member should be given access, upon request, to his or her own records.
- (e) The DAT provider should keep the record for at least two years after the attesting staff member has ceased employment with the organisation or the withdrawal of the authorisation, whichever occurs first.

GM1 DAT.TR.100(b)(2) Working methods and operating procedures

ED Decision 2017/001/R

RECORDS OF ATTESTING STAFF

Records of the attesting staff may be stored electronically.

AMC1 DAT.TR.100(b)(3) Working methods and operating procedures

ED Decision 2017/001/R

EVIDENCE OF THE SCOPE OF THE ATTESTING STAFF AUTHORISATION

- (a) The authorisation document should clearly indicate the scope of the authorisation to allow attesting staff and any other authorised persons to verify the privileges.
- (b) Attesting staff should make the authorisation document available to the competent authority upon request.

DAT.TR.105 Required interfaces

Regulation (EU) 2017/373

The DAT provider shall ensure the necessary formal interfaces with:

- (a) aeronautical data source(s) and/or other DAT providers;
- (b) the equipment design approval holder for type 2 DAT provision, or an applicant for an approval of that specific design;
- (c) aircraft operators, as applicable.

AMC1 DAT.TR.105(a) Required interfaces

ED Decision 2017/001/R

INTERFACES WITH THE AERONAUTICAL DATA SOURCE AND/OR OTHER DAT PROVIDERS

- (a) The DAT provider should demonstrate that formal interfaces with aeronautical data sources or other DAT providers are implemented. Procedures should be established to communicate instances of erroneous, inconsistent or missing data to such providers and monitor that timely and effective responses are received.
- (b) Where resolution and correction cannot be obtained for data that has been called into question, the DAT provider's procedures for dealing with this situation should ensure that the DAT provider communicates the alteration or removal of data which the aeronautical data source and/or other DAT provider has not concurred with or resolved. The DAT provider's procedures should confirm that effective controls are in place to ensure that an unsafe product is not released and that such concerns are communicated to customers in accordance with the requirements laid down in [DAT.OR.200](#).

AMC1 DAT.TR.105(b) Required interfaces

ED Decision 2017/001/R

INTERFACES WITH THE AIRCRAFT EQUIPMENT DESIGN APPROVAL HOLDER FOR TYPE 2 DAT PROVISION

The DAT provider should demonstrate that formal interfaces exist with the equipment design approval holder. In particular, the DAT provider's procedures should stipulate that the equipment design approval holder communicates and responds to issues and constraints concerning compatibility/eligibility for installation between their equipment and the databases of the DAT provider.

AMC1 DAT.TR.105(c) Required interfaces

ED Decision 2017/001/R

INTERFACES WITH AIRCRAFT OPERATORS — TYPE 2 DAT PROVIDERS

The Type 2 DAT provider should demonstrate that a formal interface with aircraft operators is in place to confirm that operators' requests are clearly defined and subject to review.

ANNEX VIII — PART-CNS

SPECIFIC REQUIREMENTS FOR PROVIDERS OF COMMUNICATION, NAVIGATION, OR SURVEILLANCE SERVICES

SUBPART A — ADDITIONAL ORGANISATION REQUIREMENTS FOR PROVIDERS OF COMMUNICATION, NAVIGATION, OR SURVEILLANCE SERVICES (CNS.OR)

SECTION 1 — GENERAL REQUIREMENTS

CNS.OR.100 Technical and operational competence and capability

Regulation (EU) 2017/373

- (a) A communication, navigation or surveillance services provider shall ensure the availability, continuity, accuracy and integrity of their services.
- (b) A communication, navigation or surveillance services provider shall confirm the quality level of the services they are providing, and shall demonstrate that their equipment is regularly maintained and, where required, calibrated.

AMC1 CNS.OR.100 Technical and operational competence and capability

ED Decision 2021/008/R

- (a) In this AMC:
 - (1) SAR point of contact (SPOC) refers to a SAR point of contact that is designated by a State to receive COSPAS-SARSAT distress data in accordance with ICAO Annex 12;
 - (2) 'competent SPOC' refers to the SAR point of contact that is competent for the SAR region(s) where an aircraft in distress is indicated to be by the transmitted information; and
 - (3) 'transmission service for locating an aircraft in distress' refers to a service that transmits to the competent SPOC information that is contained in signals sent by an airborne system, to comply with point CAT.GEN.MPA.210 'Location of an aircraft in distress' of Annex IV (Part-CAT) to Regulation (EU) No 965/2012 ('Air OPS Regulation').
- (b) A surveillance service provider for which EASA is the competent authority pursuant to Article 80 of Regulation (EU) No 2018/1139 ('Basic Regulation') may provide the transmission service as per point (a) of this AMC; in that case, the surveillance service provider should:
 - (1) establish the performance specifications of the transmission service as per point (a);

-
- (2) establish a list of airborne systems that are compatible with their use for locating an aircraft in distress as specified in the Certification Specifications for Airborne Communications, Navigation and Surveillance (CS-ACNS), Subpart E, Section 3;
 - (3) demonstrate that the transmission service as per point (a) can:
 - (i) automatically process activation signals and deactivation signals that are received from any compatible airborne system that is listed as per point (b)(2) of this AMC in the conditions specified in the CS-ACNS Subpart E, Section 3; and
 - (ii) automatically transmit to the competent SPOC the information that is contained in those signals;
 - (4) demonstrate that the transmission service as per point (a) can process signals that are simultaneously transmitted by up to 15 compatible airborne systems as per point (b)(2);
 - (5) demonstrate that the total time from transmission of a signal by a compatible airborne system as per point (b)(2) to delivering the corresponding data to the competent SPOC does not exceed 20 minutes, with a probability of 95 %;
 - (6) demonstrate that the SPOC contact information that is used by the transmission service as per point (a) to meet point (b)(3) of this AMC is global and that there are processes to maintain this information up to date;
 - (7) deliver the data to the competent SPOC in plain text and in a format recognised by the International Aeronautical and Maritime Search and Rescue Manual (IAMSAR Manual); and
 - (8) perform an operational record-keeping function that:
 - (i) integrally records data corresponding to signals transmitted by a compatible airborne system as per point (b)(2);
 - (ii) retains this data for at least 30 days; and
 - (iii) can retrieve data that is recorded in the preceding 48 hours within 30 minutes of receiving an appropriate request.

SUBPART B — TECHNICAL REQUIREMENTS FOR PROVIDERS OF COMMUNICATION, NAVIGATION OR SURVEILLANCE SERVICES (CNS.TR)

SECTION 1 — GENERAL REQUIREMENTS

CNS.TR.100 Working methods and operating procedures for providers of communication, navigation or surveillance services

Regulation (EU) 2017/373

A communication, navigation or surveillance services provider shall be able to demonstrate that its working methods and operating procedures are compliant with the standards of Annex 10 to the Chicago Convention on aeronautical telecommunications in the following versions as far as they are relevant to the provision of communication, navigation or surveillance services in the airspace concerned:

- (a) Volume I on radio navigation aids in its 6th edition of July 2006, including all amendments up to and including No 89;
- (b) Volume II on communication procedures, including those with PANS status in its 6th edition of October 2001, including all amendments up to and including No 89;
- (c) Volume III on communications systems in its 2nd edition of July 2007, including all amendments up to and including No 89;
- (d) Volume IV on surveillance radar and collision avoidance systems in its 4th edition of July 2007, including all amendments up to and including No 89;
- (e) Volume V on aeronautical radio frequency spectrum utilisation in its 3rd edition of July 2013, including all amendments up to and including No 89.

**ACCEPTABLE MEANS OF COMPLIANCE (AMC) AND GUIDANCE
MATERIAL (GM) TO PART-CNS SPECIFIC REQUIREMENTS FOR
PROVIDERS OF COMMUNICATION, NAVIGATION, OR SURVEILLANCE
SERVICES**

Reserved

ANNEX IX — PART-ATFM

SPECIFIC REQUIREMENTS FOR PROVIDERS OF AIR TRAFFIC FLOW MANAGEMENT

TECHNICAL REQUIREMENTS FOR PROVIDERS OF AIR TRAFFIC FLOW MANAGEMENT (ATFM.TR)

SECTION 1 — GENERAL REQUIREMENTS

ATFM.TR.100 Working methods and operating procedures for providers of air traffic flow management

Regulation (EU) 2017/373

An air traffic flow management provider shall be able to demonstrate that its working methods and operating procedures are compliant with Commission Regulations [\(EU\) No 255/2010](#)¹ and [\(EU\) No 677/2011](#).

¹ Commission Regulation (EU) No 255/2010 of 25 March 2010 laying down common rules on air traffic flow management (OJ L 80, 26.3.2010, p. 10).

ACCEPTABLE MEANS OF COMPLIANCE (AMC) AND GUIDANCE MATERIAL (GM) TO PART-ATFM

Reserved

ANNEX X — PART-ASM

SPECIFIC REQUIREMENTS FOR PROVIDERS OF AIRSPACE MANAGEMENT

TECHNICAL REQUIREMENTS FOR PROVIDERS OF AIRSPACE MANAGEMENT (ASM.TR)

SECTION 1 — GENERAL REQUIREMENTS

ASM.TR.100 Working methods and operating procedures for providers of airspace management

Regulation (EU) 2017/373

An airspace management provider shall be able to demonstrate that its working methods and operating procedures are compliant with Commission Regulations [\(EC\) No 2150/2005](#)¹ and [\(EU\) No 677/2011](#).

¹ Commission Regulation (EC) No 2150/2005 of 23 December 2005 laying down common rules for the flexible use of airspace (OJ L 342, 24.12.2005, p. 20).

GM1 TO AMC1 ATS.TR.210(A)(3) OPERATION OF AIR TRAFFIC CONTROL SERVICE

Reserved

ANNEX XI — PART-FPD

SPECIFIC REQUIREMENTS FOR PROVIDERS OF FLIGHT PROCEDURE DESIGN SERVICES

SUBPART A — ADDITIONAL ORGANISATION REQUIREMENTS FOR PROVIDERS OF FLIGHT PROCEDURE DESIGN SERVICES (FPD.OR)

SECTION 1 — GENERAL REQUIREMENTS

FPD.OR.100 Flight procedure design (FPD) services

Commission Implementing Regulation (EU) 2020/469

- (a) A flight procedure design services provider shall perform design, documentation and validation of flight procedure(s) subject, if necessary, to approval by the competent authority thereof before being deployed and used.

In this context, the aeronautical data and aeronautical information used by the FPD provider shall meet the requirements of accuracy, resolution, and integrity as specified in the aeronautical data catalogue in accordance with [Appendix 1 to Annex III](#) (Part-ATM/ANS.OR).

- (b) If aeronautical data for the design of flight procedures is not provided by an authoritative source or does not meet the applicable data quality requirements (DQRs), such aeronautical data may be obtained from other sources by the FPD provider. In this context, such aeronautical data shall be validated by the FPD provider intending to use it.

AMC1 FPD.OR.100 Flight procedure design (FPD) services

ED Decision 2020/008/R

SOURCE

The FPD provider should use data coming from authoritative sources. If the data used is not formally made available by an authoritative source or does not meet the applicable data quality requirements (DQRs), but is required by end users, the FPD provider may use data from other (non-authoritative) sources, provided such data has been verified and validated by the FPD provider itself and/or other ATM/ANS providers to conform with the relevant standards and DQRs.

GM1 to AMC1 FPD.OR.100 Flight procedure design (FPD) services

ED Decision 2020/008/R

NON-AUTHORITATIVE SOURCE

- (a) A non-authoritative source may be an organisation other than those defined in point 32 of Annex I, but providing and/or publishing data derived from data gathering or measuring performed (e.g. by aircraft operators, air crew, DAT providers, or other similar operational

organisations, or a combination thereof), transforming various sources to provide aeronautical data which conform to relevant standards and DQRs as specified by the airspace end users.

- (b) When validating data from a non-authoritative source, the FPD provider should proceed by using either additional information sources to validate this data (like satellite imagery, data or manuals from other providers, users, military, etc.), or data which has been tested and confirmed through operations.
- (c) The first known FPD provider that uses data coming from other (non-authoritative) sources in the aeronautical data chain accepts the responsibility of the data originator (i.e. ensuring that the data meets the DQRs).

GM1 FPD.OR.100 Flight procedure design (FPD) services

ED Decision 2020/008/R

GENERAL

- (a) If the flight procedure(s) or a change thereto result in a change to the functional system of an ATS provider, a safety assessment of the change to the functional system in accordance with [ATS.OR.205](#) needs to be carried out by that ATS provider before the deployment of that flight procedure.
- (b) In other situations, the organisations that perform the safety assessment may vary. For instance, the safety assessment of the a change of flight procedure(s) at an aerodrome may be performed by the aerodrome operator as per ADR.OR.B.040(f) of [Commission Regulation \(EU\) No 139/2014](#) or as per national legislation for aerodromes that are not certified in accordance with [Commission Regulation \(EU\) No 139/2014](#).
- (c) An approval may not be required, when there are minor changes, including but not limited to:
 - (1) publication of new standard instrument departures (SIDs), as a result of shortening already published SIDs;
 - (2) incorporation in existing standard instrument arrivals (STARs) routes of segments already published in other STARs, with altitudes equal to or higher than those published;
 - (3) change in the procedure approach chart identification: transition planning for change to instrument flight procedure approach chart identification from RNAV to RNP, according to ICAO Circular 353; and
 - (4) removal of segments of SID or STAR to the flight procedures.

GM2 FPD.OR.100 Flight procedure design (FPD) services

ED Decision 2020/008/R

DESIGN AND DOCUMENTATION

Design and documentation of flight procedures includes maintenance and periodic review activities.

In reference to periodic review, please refer to [AMC1 Article 3\(9\)](#) Provision of ATM/ANS and design of airspace structures 'PERIODIC REVIEW'.

GM3 FPD.OR.100 Flight procedure design (FPD) services

ED Decision 2020/008/R

VALIDATION OF AERONAUTICAL DATA

The processes for validating the aeronautical data by the FPD provider should meet the standards specified in EUROCAE ED-76A/RTCA DO-200B 'Standards for Processing Aeronautical Data', dated June 2015, especially Section 2.4.1 (6) and Appendix C, in particular points C.2.1 and C.2.2. EUROCAE ED-76/RTCA DO-200A may be also used for the demonstration of compliance.

FPD.OR.105 Management system

Commission Implementing Regulation (EU) 2020/469

In addition to point [ATM/ANS.OR.B.005](#) of Annex III, the FPD provider shall establish and maintain a management system that includes control procedures for:

- (a) data acquisition;
- (b) flight procedure design in accordance with design criteria as set out in point [FPD.TR.100](#);
- (c) flight procedure design documentation;
- (d) stakeholders consultation;
- (e) ground validation and, when appropriate, flight validation of flight procedure;
- (f) identification of tools, including configuration management and tools qualification, as necessary; and
- (g) maintenance and periodic review of the flight procedure(s), as applicable.

GM1 FPD.OR.105 Management system

ED Decision 2020/008/R

GENERAL

ICAO Doc 9906 Volume 1 'Flight Procedure Design Quality Assurance System' provides guidance for a flight procedure design process.

GM1 FPD.OR.105(a) Management system

ED Decision 2020/008/R

DATA ACQUISITION

The flight procedure design process starts with the verification of input data in coordination with affected stakeholders. The following aspects should be addressed:

- (a) aerodrome, navigation aids, obstacles and terrain data;
- (b) airspace data and associated requirements;
- (c) user requirements, i.e. airspace users and air traffic services provider;
- (d) airport infrastructure and equipment;
- (e) environmental considerations (e.g. population likely to be significantly affected by aircraft noise); and

- (f) any other information as potentially specified by the competent authority.

AMC1 FPD.OR.105(c) Management system

ED Decision 2020/008/R

FLIGHT PROCEDURE DESIGN DOCUMENTATION

Flight procedure design documentation should be kept at least during the lifetime of the flight procedure, unless otherwise specified by the competent authority.

GM1 FPD.OR.105(e) Management system

ED Decision 2020/008/R

GENERAL

- (a) Validation is the necessary final quality assurance step in the flight procedure design. Validation may consist of ground validation and/or flight validation. ICAO Doc 9906 Volume 5 'Validation of Instrument Flight Procedures' provides guidance for conducting the validation process for instrument flight procedures, including safety, ability to be flown and verification of data accuracy and completeness. Ground validation is always undertaken, but flight validation may not always be required.
- (b) The flight procedure may be validated using one or more of the following methods as deemed necessary for the intended use:
- (1) airspace modelling;
 - (2) ATC simulation;
 - (3) live trials;
 - (4) flight simulation;
 - (5) data analytical tools;
 - (6) statistical analysis;
 - (7) collision risk modelling; and/or
 - (8) noise and emissions modelling.

AMC1 FPD.OR.105(e) Management system

ED Decision 2020/008/R

GROUND VALIDATION

- (a) Ground validation should be always undertaken to ensure compliance with applicable requirements, i.e. to detect errors in criteria and documentation, and evaluate on the ground, to the extent possible, those elements that could be evaluated in a flight validation whenever necessary.

Ground validation should be performed by a person trained in flight procedure design as per [FPD.OR.115](#) other than the one who designed the flight procedure and with appropriate knowledge of flight validation issues.

- (b) Ground validation should include a systematic review of the steps and calculation involved in the flight procedure design and its impact, aiming at:

- (1) providing assurance that adequate obstacle and terrain clearances have been provided;
- (2) verifying that the navigation data (e.g. tracks, distances and altitudes to be flown) to be published are correct;
- (3) conducting an assessment of fly-ability to determine that the procedure can be safely flown; and
- (4) evaluating the charting, obstacle clearance and other operational factors.

AMC2 FPD.OR.105(e) Management system

ED Decision 2020/008/R

FLIGHT VALIDATION

- (a) Based on the results from the ground validation as per [AMC1 FPD.OR.105\(e\)](#), the flight validation should:
 - (1) verify that the navigation data to be published is correct;
 - (2) verify that all required infrastructure supports the procedure (e.g. runway markings, lighting, communications and navigation sources);
 - (3) verify the fly-ability of the procedure; and
 - (4) evaluate the draft charting, obstacle and terrain clearances and other operational factors.
- (b) Flight validation should be required if new navigation aids or minimum obstacle clearance reduction is affected by a change of an existing procedure.
- (c) For the airways with lower limit equal to or higher than FL145, the flight validation is not required, when the ground validation is completed and satisfied.

GM2 FPD.OR.105(e) Management system

ED Decision 2020/008/R

FLIGHT VALIDATION

- (a) Flight validation may be required if:
 - (1) the fly-ability of a procedure cannot be determined by other means;
 - (2) the procedure contains non-standard design elements (deviations from criteria e.g. non-standard approach angles/gradients, non-standard segment lengths, speeds, bank angles, etc.);
 - (3) the accuracy and/or integrity of obstacle and terrain data cannot be determined by other means;
 - (4) new procedures differ significantly from existing procedures; and
 - (5) helicopter PinS procedures are to be deployed.
- (b) ICAO Doc 9906 Volume 5 'Validation of Instrument Flight Procedures' provides further guidance for the flight validation.

FPD.OR.110 Record-keeping

Commission Implementing Regulation (EU) 2020/469

In addition to point [ATM/ANS.OR.B.030](#) of Annex III, the FPD provider shall include in its record-keeping system the elements indicated in point [FPD.OR.105](#) of this Annex.

FPD.OR.115 Technical and operational competence and capability

Commission Implementing Regulation (EU) 2020/469

- (a) In addition to point [ATM/ANS.OR.B.005\(a\)\(6\)](#) of Annex III, the FPD provider shall ensure that its flight procedure designers:
 - (1) have successfully completed a training course that provides competency in flight procedure design;
 - (2) are suitably experienced to successfully apply the theoretical knowledge; and
 - (3) successfully complete continuation training.
- (b) When flight validation is deemed necessary to be performed, the FPD provider shall ensure that it is undertaken by a competent pilot.
- (c) In addition to point [ATM/ANS.OR.B.030](#) of Annex III, the FPD provider shall maintain records of all the training as well as any design activity completed by the employed flight procedure designers and make such records available on request:
 - (1) to the flight procedure designers concerned; and
 - (2) in agreement with the flight procedure designers, to the new employer when a flight procedure designer is employed by a new entity.

AMC1 FPD.OR.115(a)(1) Technical and operational competence and capability

ED Decision 2020/008/R

TRAINING

The training should provide the flight procedure designers with:

- (a) knowledge of technical rules for the design and the establishment of instrument flight procedures;
- (b) knowledge of design criteria;
- (c) knowledge of the data catalogue, including the applicable DQRs; and
- (d) competence in designing flight procedures with the selected tools in accordance with the design criteria.

GM1 FPD.OR.115(a)(1) Technical and operational competence and capability

ED Decision 2020/008/R

TRAINING

In addition to the PANS-OPS design training, the training should consider:

- (a) [Commission Implementing Regulation \(EU\) 2017/373](#) laying down common requirements for service providers and the oversight in air traffic management/air navigation services and other air traffic management network functions;
- (b) [Commission Implementing Regulation \(EU\) No 923/2012](#) laying down the common rules of the air and operational provisions regarding services and procedures in air navigation;
- (c) design criteria defined in [FPD.TR.100](#);
- (d) ICAO Annex 4 'Aeronautical Charts';
- (e) ICAO Doc 9613 'Performance-based Navigation (PBN) Manual';
- (f) ICAO Doc 9906 'Quality Assurance Manual for Flight Procedure Design'; and
- (g) tools used in the design, which may be acquired as part of the on-the-job training.

GM2 FPD.OR.115(a)(1) Technical and operational competence and capability

ED Decision 2020/008/R

TRAINING

The FPD provider's personnel involved in the flight procedure charting and/or coding should have successfully completed a training course that provides a basic level of competency in charting and/or coding.

GM3 FPD.OR.115(a)(1) Technical and operational competence and capability

ED Decision 2020/008/R

TRAINING

ICAO Doc 9906 Volume 2 'Flight Procedure Designer Training' provides guidance for the establishment of flight procedure designer training and possible content.

AMC1 FPD.OR.115(a)(2) Technical and operational competence and capability

ED Decision 2020/008/R

FLIGHT PROCEDURE DESIGNER EXPERIENCE

In order for flight procedure designers to show that they are suitably experienced to successfully apply the theoretical knowledge, they should be prove that they have either:

- (a) worked in flight procedure design work over a period of time specified by the competent authority; or
- (b) undergone sufficient on-the-job training. In doing so, the procedure designer should have undergone a minimum of time on-the-job PANS-OPS design training until demonstrating adequate competency in the practical application of design criteria.

GM1 to AMC1 FPD.OR.115(a)(2) Technical and operational competence and capability

ED Decision 2020/008/R

DURATION OF THE ON-THE-JOB TRAINING

The on-the-job training is recommended to be minimum 2 years. This period may be substantially reduced in cases where the designer has experience in flight procedures.

GM1 FPD.OR.115(a)(3) Technical and operational competence and capability

ED Decision 2020/008/R

CONTINUATION TRAINING

Continuation training aims at addressing changes in the applicable design criteria and regulations.

ICAO Doc 9906 Volume 2 'Flight Procedure Designer Training' provides guidance for the establishment of flight procedure designer training.

GM1 FPD.OR.115(b) Technical and operational competence and capability

ED Decision 2020/008/R

COMPETENT PILOT

ICAO Doc 9906 Volume 6 'Flight Validation Pilot Training and Evaluation' provides guidance for the establishment of flight procedure validation pilot training.

FPD.OR.120 Required interfaces

Commission Implementing Regulation (EU) 2020/469

- (a) When obtaining the aeronautical data and aeronautical information in accordance with point [FPD.OR.100](#), the FPD provider shall ensure the necessary formal arrangements are established, as applicable, with:
 - (1) aeronautical data sources;
 - (2) other service providers;
 - (3) aerodrome operators; and
 - (4) aircraft operators.
- (b) To ensure that the requests for flight procedure design are clearly defined and subject to review, the FPD service provider shall establish the necessary formal arrangements with the next intended user.

GM1 FPD.OR.120 Required interfaces

ED Decision 2020/008/R

FORMAL ARRANGEMENTS

- (a) Formal arrangements could be in, but not limited to, the form of a service-level agreement (SLA), a contract or a memorandum of understanding (MoU) that should specify the scope of aeronautical data and aeronautical information to be received/provided.
- (b) The FPD provider should demonstrate that formal arrangements with the aeronautical data sources are implemented. In this context, procedures should be established to communicate and address instances of erroneous, inconsistent or missing data.
- (c) The FPD provider's procedures should confirm that effective controls are in place to ensure that an unsafe product is not released and that such concerns are communicated to other service providers, aerodrome operators and/or aircraft operators.
- (d) The FPD provider should demonstrate that formal arrangements with the next intended user are in place to confirm that its requests are clearly defined and subject to review.

SUBPART B — TECHNICAL REQUIREMENTS FOR PROVIDERS OF FLIGHT PROCEDURE DESIGN SERVICES (FPD.TR)

SECTION 1 — GENERAL REQUIREMENTS

FPD.TR.100 Flight procedure design requirements

Commission Implementing Regulation (EU) 2020/469

The flight procedures shall be designed by flight procedure design services provider in compliance with the requirements laid down in [Appendix 1](#) and with the design criteria as determined by the competent authority, so as to ensure safe aircraft operations. The design criteria shall permit the establishment of appropriate obstacle clearance for flight procedures, where required.

AMC1 FPD.TR.100 Flight procedure design requirements

ED Decision 2020/008/R

DESIGN CRITERIA

- (a) The design criteria determined by the competent authority should be based on ICAO Doc 8168 (PANS-OPS) Volume II ‘Construction of Visual and Instrument Flight Procedures’, as last amended, so as to ensure safe aircraft operations.
- (b) As regards the required navigation performance authorisation required (RNP AR) procedure, the design criteria should be based on ICAO Doc 9905 ‘Required Navigation Performance Authorization Required (RNP AR) Procedure Design Manual’, as last amended.

FPD.TR.105 Coordinates and aeronautical data

Commission Implementing Regulation (EU) 2020/469

- (a) In addition to point [ATM/ANS.OR.A.090](#) of Annex III, geographical coordinates indicating latitude and longitude shall be determined and reported to the aeronautical information services provider(s) (AIS provider(s)) in terms of the World Geodetic System – 1984 (WGS-84) geodetic reference datum or equivalent.
- (b) The order of accuracy of the field work and the determinations and calculations derived therefrom shall be such that the resulting operational navigation data for the phases of flight are within the maximum deviations with respect to an appropriate reference frame, as specified in [Appendix 1 to Annex III](#) (Part-ATM/ANS.OR).

APPENDIX 1 — REQUIREMENTS FOR AIRSPACE STRUCTURES AND FLIGHT PROCEDURES CONTAINED THEREIN

SECTION I

Specifications for flight information regions, control areas, control zones and flight information zones

Commission Implementing Regulation (EU) 2020/469

(a) FLIGHT INFORMATION REGIONS

Flight information regions as defined in point 23 of Article 2 to [Regulation \(EC\) No 549/2004](#) shall:

- (1) cover the whole of the air route structure to be served by such regions; and
- (2) include all airspace within its horizontal limits, except when limited by an upper flight information region.

Member States shall retain their responsibilities towards the ICAO within the geographical limits of the flight information regions entrusted to them by the ICAO on the date of entry into force of this Regulation.

(b) CONTROL AREAS

- (1) Control areas shall be delineated so as to encompass sufficient airspace to contain the flight paths of those instrument flight rules (IFR) flights or portions thereof to which the applicable parts of the air traffic control (ATC) service are provided, taking into account the capabilities of the navigation aids normally used in that area.
- (2) A lower limit of a control area shall be established at a height above the ground or water of not less than 200 m (700 ft), unless otherwise prescribed by the competent authority.
- (3) An upper limit of a control area shall be established when either:
 - (i) ATC service will not be provided above such upper limit; or
 - (ii) the control area is situated below an upper control area, in which case, the upper limit shall coincide with the lower limit of the upper control area.

(c) CONTROL ZONES

- (1) The horizontal limits of a control zone shall encompass at least those portions of the airspace, which are not within control areas that contain the paths of IFR flights arriving at and departing from aerodromes to be used under instrument meteorological conditions (IMC).
- (2) If located within the horizontal limits of a control area, the control zone shall extend upwards from the surface of the earth to at least the lower limit of the control area.

(d) FLIGHT INFORMATION ZONES

- (1) The horizontal limits of a flight information zone shall encompass at least those portions of the airspace, which are neither within control areas nor within control zone, that contain the paths of IFR and/or VFR flights arriving at and departing from aerodromes.

- (2) If located within the horizontal limits of a control area, the flight information zone shall extend upwards from the surface of the earth to at least the lower limit of the control area.

AMC1 SECTION I — (a) FLIGHT INFORMATION REGIONS

ED Decision 2020/008/R

LIMITED BY AN UPPER FLIGHT INFORMATION REGION

When limited by an upper flight information region, the lower limit specified for the upper flight information region should constitute the upper vertical limit of the flight information region and should coincide with a VFR cruising level as specified in the tables in Appendix 3 to [Commission Implementing Regulation \(EU\) No 923/2012](#).

AMC1 SECTION I — (b) CONTROL AREAS

ED Decision 2020/008/R

UPPER LIMITS

When established, the upper limits of a control area should coincide with a VFR cruising level of the tables in Appendix 3 to [Commission Implementing Regulation \(EU\) No 923/2012](#).

GM1 SECTION I — (b) CONTROL AREAS

ED Decision 2020/008/R

GENERAL

- (a) When the lower limit of a control area is above 900 m (3 000 ft) mean sea level (MSL), it should coincide with a VFR cruising level as specified in the tables in Appendix 3 to [Commission Implementing Regulation \(EU\) No 923/2012](#).
- (b) In a given control area, the lower limit may be established non-uniformly.
- (c) The selected VFR cruising level of the lower limit of a control area should be such that expected local atmospheric pressure variations do not result in a lowering of this limit to a height of less than 200 m (700 ft) above ground or water.
- (d) In a control area other than one formed by a system of airways, a system of routes may be established to facilitate the provision of air traffic control.

AMC1 SECTION I — (c) CONTROL ZONES

ED Decision 2020/008/R

HORIZONTAL LIMITS

The horizontal limits of a control zone should extend to at least 9.3 km (5 NM) from the centre of the aerodrome or aerodromes concerned in the directions from which approaches will be made.

GM1 SECTION I — (c) CONTROL ZONES

ED Decision 2020/008/R

GENERAL

- (a) If a control zone is located outside of the horizontal limits of a control area, an upper limit should be established.
- (b) An upper limit higher than the lower limit of the overlying control area may be established when desired.
- (c) If it is desired to establish the upper limit of a control zone at a level higher than the lower limit of the control area established above it, or if the control zone is located outside of the lateral limits of a control area, its upper limit should be established at a level which can easily be identified by pilots. When this limit is above 900 m (3 000 ft) MSL, it should coincide with a VFR cruising level as specified in the tables in Appendix 3 to [Commission Implementing Regulation \(EU\) No 923/2012](#).
- (d) The selected VFR cruising level of the upper limit of a control zone should be such that the expected local atmospheric pressure variations do not result in a lowering of this limit to a height of less than 200 m (700 ft) above ground or water.
- (e) A control zone may include two or more aerodromes situated close together.
- (f) When designing the lateral limits of control zones, aircraft holding in the vicinity of aerodromes are considered as arriving aircraft.

SECTION II

Identification of ATS routes other than standard departure and arrival routes

Commission Implementing Regulation (EU) 2020/469

- (a) When ATS routes are established, a protected airspace along each ATS route and a safe spacing between adjacent ATS routes shall be provided.
- (b) ATS routes shall be identified through designators.
- (c) When identifying ATS routes other than standard departure and arrival routes, the designation system used shall:
 - (1) permit the identification of any ATS route in a simple and unique manner;
 - (2) avoid redundancy;
 - (3) be usable by both ground and airborne automation systems;
 - (4) permit utmost brevity in operational use; and
 - (5) provide for a sufficient possibility of extension to cater for any future requirements without the need for fundamental changes;
- (d) Basic ATS route designators shall be assigned in accordance with the following principles:
 - (1) the same basic designator shall be assigned to a main trunk route throughout its entire length, irrespective of terminal control areas, States or regions traversed;
 - (2) where two or more trunk routes have a common segment, the segment in question shall be assigned each of the designators of the routes concerned, except where this would introduce difficulties in the provision of air traffic services (ATS), in which case, by common agreement, one designator only shall be assigned; and
 - (3) a basic designator assigned to one route shall not be assigned to any other route.

AMC1 SECTION II

ED Decision 2020/008/R

GENERAL

Controlled, advisory and uncontrolled ATS routes, with the exception of standard arrival and departure routes should be identified as follows:

- (a) The basic designator should consist of one letter of the alphabet followed by a number from 1 to 999. The selection of the letter should be made from those listed hereunder:
 - (1) 'A', 'B', 'G', 'R' for routes which form part of the regional networks of ATS routes and are not area navigation routes;
 - (2) 'L', 'M', 'N', 'P' for area navigation routes which form part of the regional networks of ATS routes;
 - (3) 'H', 'J', 'V', 'W' for routes which do not form part of the regional networks of ATS routes and are not area navigation routes; and

- (4) 'Q', 'T', 'Y', 'Z' for area navigation routes which do not form part of the regional networks of ATS routes.
- (b) The ATS route designator should consist of a basic designator supplemented, if necessary, by:
- (1) one prefix; where applicable, one supplementary letter may be added as a prefix to the basic designator in accordance with the following:
 - (i) 'K' to indicate a low-level route established for use primarily by helicopters;
 - (ii) 'U' to indicate that the route or portion thereof is established in the upper airspace; and
 - (iii) 'S' to indicate a route established exclusively for use by supersonic aircraft during acceleration, deceleration and while in supersonic flight; and
 - (2) one additional letter; when prescribed by the competent authority or on the basis of regional air navigation agreements, a supplementary letter may be added after the basic designator of the ATS route in question in order to indicate the type of service provided in accordance with the following:
 - (i) 'F' to indicate that on the route or portion thereof only advisory service is provided; and
 - (ii) 'G' to indicate that on the route or portion thereof only flight information service is provided.
- (c) The number of characters required to compose the designator should not exceed six.
- (d) The number of characters required to compose the designator should, whenever possible, be kept to a maximum of five.

GM1 SECTION II

ED Decision 2020/008/R

GENERAL

- (a) Guidance material on the establishment of ATS routes and procedures is contained in ICAO Doc 9426 'Air Traffic Services Planning Manual'.
- (b) Guidance material on the establishment of ATS routes defined by omni-directional range (VOR) is contained in Attachment A to ICAO Annex 11.
- (c) Guidance material on ICAO Codes and Routes Designators (ICARD) is contained in the ICAO Five-Letter Name-Codes (5LNC) Guidelines.
- (d) The spacing between parallel tracks or between parallel ATS route centre lines based on performance-based navigation should be dependent upon the relevant navigation specification required.
- (e) When warranted by density, complexity or nature of the traffic, special routes should be established for use by low-level traffic, including helicopters operating to and from helidecks on the high seas. When determining the horizontal spacing between such routes, account should be taken of the navigational means available and the navigation equipment carried on helicopters' board.

SECTION III

Identification of standard departure and standard arrival routes and associated procedures

Commission Implementing Regulation (EU) 2020/469

- (a) When identifying standard departure and standard arrival routes and associated procedures, it shall be ensured that:
 - (1) the system of designators shall permit the identification of each route in a simple and unambiguous manner;
 - (2) each route shall be identified by a plain language designator and a corresponding coded designator; and
 - (3) in voice communications, the designators shall be easily recognisable as relating to a standard departure or standard arrival route and shall not create any difficulties in pronunciation for pilots and ATS personnel.
- (b) When composing designators for standard departure and standard arrival routes and associated procedures, the following shall be used:
 - (1) a plain language designator;
 - (2) a basic indicator;
 - (3) a validity indicator that shall be a number from 1 to 9;
 - (4) a route indicator that shall be one letter of the alphabet; the letters 'I' and 'O' shall not be used; and
 - (5) a coded designator of a standard departure or standard arrival route, instrument or visual.
- (c) Assignment of designators
 - (1) Each route shall be assigned a separate designator.
 - (2) To distinguish between two or more routes that relate to the same significant point (and are therefore assigned the same basic indicator), a separate route indicator as described in point (b)(4) shall be assigned to each route.
- (d) Assignment of validity indicators
 - (1) A validity indicator shall be assigned to each route to identify the route that is currently in effect.
 - (2) The first validity indicator to be assigned shall be the number '1'.
 - (3) Whenever a route is amended, a new validity indicator, which consists of the next higher number, shall be assigned. The number '9' shall be followed by the number '1'.

AMC1 SECTION III — (a)(1)

ED Decision 2020/008/R

SYSTEM OF DESIGNATORS

The system of designators should:

- (a) make a clear distinction between:
 - (1) departure routes and arrival routes;
 - (2) departure or arrival routes and other ATS routes; and
 - (3) routes requiring navigation by reference to ground-based radio aids or self-contained airborne aids, and routes requiring navigation by visual reference to the ground;
- (b) be compatible with ATS and aircraft data processing and display requirements;
- (c) be of utmost brevity in its operational application;
- (d) avoid redundancy; and
- (e) provide sufficient possibility for extension to cater for any future requirements without the need for fundamental changes.

GM1 to AMC1 SECTION III — (a)(1)

ED Decision 2020/008/R

SYSTEM OF DESIGNATORS

The term 'route' is used in the meaning of 'route and associated procedures'.

AMC1 SECTION III — (a)(2)

ED Decision 2020/008/R

PLAIN LANGUAGE DESIGNATOR

A plain language designator of a standard departure or arrival route should consist of:

- (a) a basic indicator followed by;
- (b) a validity indicator followed by;
- (c) a route indicator, where required, followed by;
- (d) the word 'departure' or 'arrival' followed by;
- (e) the word 'visual', if the route has been established for use by aircraft operating in accordance with the visual flight rules (VFR) or in accordance with the instrument flight rules (IFR) under visual meteorological conditions (VMC).

AMC1 SECTION III — (b)(2)

ED Decision 2020/008/R

BASIC INDICATOR

The basic indicator should be considered the name or name-code of the significant point where a standard departure route terminates or a standard arrival route begins.

AMC1 SECTION III — (b)(5)

ED Decision 2020/008/R

CODED DESIGNATOR

The coded designator of a standard departure or standard arrival route, instrument or visual, should consist of:

- (a) the coded designator or name-code of the significant point followed by;
- (b) the validity indicator followed by;
- (c) the route indicator, where required.

GM1 SECTION III

ED Decision 2020/008/R

GENERAL

- (a) Guidance material relating to the establishment of standard departure and arrival routes and associated procedures is contained in ICAO Doc 9426 'Air Traffic Services Planning Manual'.
- (b) The flight procedure naming convention is contained in ICAO Doc 8168 (PANS-OPS) Volume II 'Construction of Visual and Instrument Flight Procedures', as last amended.
- (c) The plain language designator used for the phraseology is contained in ICAO Doc 4444 (PANS-ATM) 'Air Traffic Management', as last amended.
- (d) The runway designator detailed requirements are contained in ICAO Annex 14 Volume I, Section 5.2.2.
- (e) Examples of plain language and coded designators for standard departure and arrival routes and associated procedures

- (1) Example 1: Standard departure route — instrument

Plain language designator: BRECON ONE DEPARTURE

Coded designator: BCN 1

Meaning: The designator identifies a standard instrument departure route which terminates at the significant point BRECON (basic indicator). BRECON is a radio navigation facility with the identification BCN (basic indicator of the coded designator). The validity indicator ONE (1 in the coded designator) signifies either that the original version of the route is still in effect or that a change has been made from the previous version NINE (9) to the now effective version ONE (1). The absence of a route indicator signifies that only one route, in this case a departure route, has been established with reference to BRECON.

- (2) Example 2: Standard arrival route — instrument

Plain language designator: KODAP TWO ALPHA ARRIVAL

Coded designator: KODAP2A

Meaning: This designator identifies a standard instrument arrival route which begins at the significant point KODAP (basic indicator). KODAP is a significant point not marked by the site of a radio navigation facility and therefore assigned a five-letter name-code in accordance with Appendix 2 to ICAO Annex 11. The validity indicator TWO (2) signifies that a change has been made from the previous version ONE (1) to the now effective

version TWO (2). The route indicator ALPHA (A) identifies one of several routes established with reference to KODAP and is a specific character assigned to this route.

(3) Example 3: Standard departure route — visual

Plain language designator: ADOLA FIVE BRAVO DEPARTURE VISUAL

Coded designator: ADOLA 5 B

Meaning: This designator identifies a standard departure route with visual portion of flight, which terminates at ADOLA, a significant point not marked by the site of a radio navigation facility. The validity indicator FIVE (5) signifies that a change has been made from the previous version FOUR (4) to the now effective version FIVE (5). The route indicator BRAVO (B) identifies one of several routes established with reference to ADOLA.

(f) Examples of plain language and coded designators for approach procedures

(1) Example 1: Instrument approach to a runway

Plain language designator: RNP ZULU APPROACH RUNWAY ONE EIGHT

Coded designator: RNP Z RWY18

Meaning: The designator identifies an RNAV approach procedure to runway 18. The suffix letter ZULU (Z) identifies one of several RNAV approaches established on runway 18 and is a specific character assigned to this procedure.

(2) Example 2: Instrument approach to a runway

Plain language designator: ILS ZULU APPROACH RUNWAY THREE TWO

Coded designator: ILS Z RWY32

Meaning: The designator identifies an ILS approach procedure to runway 32. The suffix letter ZULU (Z) identifies one of several ILS approaches established on runway 32 and is a specific character assigned to this procedure.

(3) Example 3: Instrument approach to a helipad (PinS)

Plain language designator: RNP APPROACH TWO THREE TWO

Coded designator: RNP 232

Meaning: The designator identifies an RNAV approach procedure to a helipad for which the final approach track is equal to 232°.

(g) In this section, the term ‘route’ is used in the meaning of ‘route and associated procedures’.

SECTION IV

Establishment and identification of significant points

Commission Implementing Regulation (EU) 2020/469

- (a) Significant points shall be established for the purpose of defining an ATS route or flight procedure and/or in relation to the ATS requirements for information on the progress of aircraft in flight.
- (b) Significant points shall be identified by designators.

AMC1 SECTION IV

ED Decision 2020/008/R

GENERAL

- (a) The significant points should, whenever possible, be established with reference to ground-based or space-based radio navigation aids. Where such ground-based or space-based radio navigation aids do not exist, significant points should be established at a location which can be determined by self-contained airborne navigation aids, or, where navigation by visual reference to the ground is to be effected, by visual observation. Specific points may be designated as 'transfer of control' points by agreement between adjacent air traffic control units or control positions concerned.
- (b) The designator for a significant point should be marked by the site of a radio navigation aid.
 - (1) Plain language name for significant points marked by the site of a radio navigation aid
 - (i) Whenever practicable, significant points should be named with reference to an identifiable and preferably prominent geographical location.
 - (ii) In selecting a name for the significant point, care should be taken to ensure that the following conditions are met:
 - (A) the name should not create difficulties in pronunciation for pilots or ATS personnel when speaking in the language used in ATS communications. Where the name of a geographical location in the national language selected for designating a significant point gives rise to difficulties in pronunciation, an abbreviated or contracted version of this name, which retains as much of its geographical significance as possible, should be selected (for example, FUERSTENFELDBRUCK = FURSTY);
 - (B) the name should be easily recognisable in voice communications and should be free of ambiguity with those of other significant points in the same general area. In addition, the name should not create confusion with respect to other communications exchanged between air traffic services and pilots;
 - (C) the name should, if possible, consist of at least six letters and form two syllables and preferably not more than three; and
 - (D) the selected name should be the same for both the significant point and the radio navigation aid marking it.

-
- (2) Composition of coded designators for significant points marked by the site of a radio navigation aid
- (i) The coded designator should be the same as the radio identification of the radio navigation aid. It should be so composed, if possible, as to facilitate association with the name of the point in plain language.
 - (ii) Coded designators should not be duplicated within 1 100 km (600 NM) of the location of the radio navigation aid concerned, except as noted hereunder.
 - (iii) States' requirements for coded designators should be notified to the Regional Offices of ICAO for coordination.
- (c) The designator for a significant point not marked by the site of a radio navigation aid
- (1) Where a significant point is required at a position not marked by the site of a radio navigation aid, and is used for ATC purposes, it should be designated by a unique five-letter pronounceable 'name-code'. This name-code designator then serves both as the name as well as the coded designator of the significant point.
 - (2) The name-code designator should be selected so as to avoid any difficulties in pronunciation by pilots or ATS personnel when speaking in the language used in ATS communications.

Examples: ADOLA, KODAP
 - (3) The name-code designator should be easily recognisable in voice communications and should be free of ambiguity with those used for other significant points in the same general area.
 - (4) The unique five-letter pronounceable name-code designator assigned to a significant point should not be assigned to any other significant point. When there is a need to relocate a significant point, a new name-code designator should be chosen. In cases when a State wishes to keep the allocation of specific name-codes for reuse at a different location, such name-codes should not be used until after a period of at least 6 months.
 - (5) States' requirements for unique five-letter pronounceable name-code designators should be notified to the Regional Offices of ICAO for coordination.
 - (6) In areas where no system of fixed routes is established or where the routes followed by aircraft vary depending on operational considerations, significant points should be determined and reported in terms of World Geodetic System — 1984 (WGS-84) geographical coordinates, except that permanently established significant points serving as exit and/or entry points into such areas should be designated.
- (d) The significant points are used for reporting purposes
- (1) In order to permit ATS to obtain information regarding the progress of aircraft in flight, selected significant points may need to be designated as reporting points.
 - (2) In establishing such points, consideration should be given to the following factors:
 - (i) the type of air traffic services provided;
 - (ii) the amount of traffic normally encountered;
 - (iii) the accuracy with which aircraft are capable of adhering to the current flight plan;
 - (iv) the speed of the aircraft;

- (v) the separation minima applied;
 - (vi) the complexity of the airspace structure;
 - (vii) the control method(s) employed;
 - (viii) the start or end of significant phases of a flight (climb, descent, change of direction, etc.);
 - (ix) transfer of control procedures;
 - (x) safety and search and rescue aspects;
 - (xi) the cockpit and air-ground communication workload.
- (3) Reporting points should be established either as ‘compulsory’ or as ‘on-request’.
- (4) In establishing ‘compulsory’ reporting points, the following principles should apply:
- (i) compulsory reporting points should be limited to the minimum necessary for the routine provision of information to air traffic services units on the progress of aircraft in flight, bearing in mind the need to keep cockpit and controller workload and air-ground communications load to a minimum;
 - (ii) the availability of a radio navigation aid at a location should not necessarily determine its designation as a compulsory reporting point; and
 - (iii) compulsory reporting points should not necessarily be established at flight information region or control area boundaries.
- (5) The designation of compulsory and on-request reporting points should be reviewed regularly with a view to keeping the requirements for routine position reporting to the minimum necessary to ensure efficient air traffic services.

GM1 SECTION IV

ED Decision 2020/008/R

GENERAL

- (a) When two radio navigation aids operating in different bands of the frequency spectrum are situated at the same location, their radio identifications are normally the same.
- (b) ‘On-request’ reporting points may be established in relation to the requirements of air traffic services for additional position reports when traffic conditions so demand.
- (c) The ICAO International Codes and Routes Designators (ICARD) system is used to manage the allocation of unique five-letter name-codes (5LNC) for significant points. They are notified to the Regional Offices of ICAO for coordination and registration on the ‘ICAO five-letter name-codes and route designators (ICARD)’ data base system.
- (d) Additional details on the use of the ICARD system and associated database can be found in the ‘ICAO codes and route designators. Five-Letter Name-Codes. Guidelines’.
- (e) To avoid confusion, the significant point designator should not be reused for a period of at least 6 months after cancellation of the point to which they refer.

SECTION V

Minimum flight altitudes

Commission Implementing Regulation (EU) 2020/469

Minimum flight altitudes shall be determined for each ATS route and control area and shall be provided for promulgation. These minimum flight altitudes shall provide a minimum obstacle clearance within the areas concerned.

GM1 SECTION V

ED Decision 2020/008/R

GENERAL

- (a) An altitude determined and published for each segment of the route provides the required minimum obstacle clearance (MOC) above obstacles contained inside the obstacle clearance areas.
- (b) Procedure altitude/height is used in defining the vertical profile of the flight procedure at or above the minimum obstacle clearance altitude/height, where established.

SECTION VI

Identification and delineation of prohibited, restricted and danger areas

Commission Implementing Regulation (EU) 2020/469

When prohibited areas, restricted areas or danger areas are established, upon initial establishment, they shall be given an identification, and full details shall be provided for promulgation.

AMC1 SECTION VI

ED Decision 2020/008/R

IDENTIFICATION OF PROHIBITED, RESTRICTED AND DANGER AREAS

- (a) The identification should be used to identify the area in all subsequent notifications pertaining to that area.
- (b) The identification should be composed of a group of letters and figures as follows:
 - (1) nationality letters for location indicators assigned to the State or territory which has established the airspace;
 - (2) the letter 'P' for prohibited area, the letter 'R' for restricted area, and the letter 'D' for danger area as appropriate;
 - (3) a number, unduplicated within the State or territory concerned.
- (c) To avoid confusion, identification numbers should not be reused for a period of at least 1 year after cancellation of the area to which they refer.

GM1 SECTION VI

ED Decision 2020/008/R

PROHIBITED, RESTRICTED AND DANGER AREAS

- (a) When a prohibited, restricted or danger area is established, the area should be as small as practicable and be contained within simple geometrical limits, so as to permit ease of reference by all concerned.
- (b) Nationality letters are those contained in ICAO Doc 7910 'Location Indicators'.

ANNEX XII — PART-NM

SPECIFIC REQUIREMENTS FOR THE NETWORK MANAGER

TECHNICAL REQUIREMENTS FOR THE NETWORK MANAGER (NM.TR)

SECTION 1 — GENERAL REQUIREMENTS

NM.TR.100 Working methods and operating procedures for the Network Manager

Regulation (EU) 2017/373

The Network Manager shall be able to demonstrate that its working methods and operating procedures are compliant with other Union legislation and in particular with [Regulation \(EU\) No 255/2010](#) and [\(EU\) No 677/2011](#).

ACCEPTABLE MEANS OF COMPLIANCE (AMC) AND GUIDANCE MATERIAL (GM) TO PART-NM SPECIFIC REQUIREMENTS FOR THE NETWORK MANAGER

Reserved

ANNEX XIII — PART-PERS

REQUIREMENTS FOR SERVICE PROVIDERS CONCERNING PERSONNEL TRAINING AND COMPETENCE ASSESSMENT

SUBPART A — AIR TRAFFIC SAFETY ELECTRONICS PERSONNEL

SECTION 1 — GENERAL REQUIREMENTS

ATSEP.OR.100 Scope

Regulation (EU) 2017/373

- (a) This Subpart establishes the requirements to be met by the service provider with respect to the training and the competence assessment of air traffic safety electronics personnel (ATSEP).
- (b) For the service providers applying for a limited certificate in accordance with points (a) and (b) of point [ATM/ANS.OR.A.010](#) and/or declaring its activities in accordance with point [ATM/ANS.OR.A.015](#), the minimum requirements to be met with respect to the training and the competence assessment of ATSEP may be determined by the competent authority. Those minimum requirements shall be based on qualification, experience and recent experience, to maintain specific equipment or types of equipment and ensuring equivalent level of safety.

GM1 ATSEP.OR.100 Scope

ED Decision 2020/020/R

GENERAL

It is acknowledged that ‘power supply’ and ‘air conditioning’ systems and equipment can be critical elements of the aviation safety chain and that personnel should be competent in those areas. Personnel that maintain these systems should not be considered as ATSEP. In general, ATSEP do not work on these systems, but rather control and manage the release of power supply and air conditioning systems, to and from operational service.

ATSEP.OR.105 Training and competence assessment programme

Regulation (EU) 2017/343

In accordance with point [ATM/ANS.OR.B.005\(a\)\(6\)](#), the service provider employing ATSEP shall establish a training and competence assessment programme to cover the duties and responsibilities to be performed by ATSEP.

When ATSEP are employed by a contracted organisation, the service provider shall ensure that those ATSEP have received the applicable training and competences foreseen in this Subpart.

AMC1 ATSEP.OR.105 Training and competence assessment

ED Decision 2020/020/R

GENERAL — METEOROLOGICAL SERVICE PROVIDERS, AERONAUTICAL INFORMATION SERVICE PROVIDERS, DATA SERVICE PROVIDERS, FLIGHT PROCEDURE DESIGN SERVICE PROVIDERS

- (a) Service providers should identify authorised personnel who are competent to operate, maintain, release from, and return into operations equipment of the functional system.
- (b) Service providers could demonstrate compliance with the relevant requirements of Subpart A — AIR TRAFFIC SAFETY ELECTRONICS PERSONNEL of Annex XIII (Part-PERS) to Regulation (EU) 2017/373 by performing a gap analysis (e.g. a specific compliance matrix) that describes and compares the requirements for the training of the persons identified as air traffic safety electronics personnel (ATSEP), as well as for their qualification, experience, and recent experience, and by maintaining specific equipment or types of equipment to ensure an equivalent level of safety thereof.
- (c) The gap analysis (e.g. specific compliance matrix) that is referred to in point (b) should also detail the competence assessment(s) to be conducted by the service providers for ATSEP that meet the applicable requirements, and include copies or references of all the documents that are required for demonstrating compliance.

GM1 to AMC1 ATSEP.OR.105(b) Training and competence

ED Decision 2020/020/R

GENERAL — METEOROLOGICAL SERVICE PROVIDERS, AERONAUTICAL INFORMATION SERVICE PROVIDERS, DATA SERVICE PROVIDERS, FLIGHT PROCEDURE DESIGN SERVICE PROVIDERS

The gap analysis (e.g. specific compliance matrix) should:

- (a) describe the qualification, experience, and recent experience of the ATSEP;
- (b) indicate for which requirements of Subpart A of Part-PERS exemptions should be granted;
- (c) indicate the training, including the required examinations and assessments, to be provided to the ATSEP; and
- (d) include an assessment that confirms that the compliance of the ATSEP with the training, examination, and assessment requirements that are described in the analysis can be considered as equivalent to the successful completion of the training that is required by Regulation (EU) 2017/373 for the purpose of demonstrating compliance.

GM2 to AMC1 ATSEP.OR.105(b) Training and competence assessment programme

ED Decision 2020/020/R

GENERAL — METEOROLOGICAL SERVICE PROVIDERS, AERONAUTICAL INFORMATION SERVICE PROVIDERS, DATA SERVICE PROVIDERS, FLIGHT PROCEDURE DESIGN SERVICE PROVIDERS

The authorised persons who are competent to operate, maintain, release from, and return into operations equipment of the functional system may be information technology (IT) personnel or technicians with maintenance tasks at a service provider.

GM1 ATSEP.OR.105 Training and competence assessment programme

ED Decision 2017/001/R

GENERAL

The training and competence assessment programme should include:

- (a) the training policy;
- (b) the description of all training activities and the interrelations between different training activities;
- (c) the description of the function/role of the phase/course supervisor, instructors and assessors;
- (d) the description of the qualifications of instructional and competence assessment personnel;
- (e) the target group of learners;
- (f) the description of the minimum qualification of learners or required entry levels ('learner' is the generic term for a person performing a learning activity without any reference to his or her status (ab initio/student/trainee));
- (g) the description of knowledge outcome and performance objectives;
- (h) the record of supervisory, instructional and competence assessment personnel participating in a course;
- (i) the training environment (e.g. infrastructure, equipment, etc.);
- (j) the training methodology (e.g. classroom instruction, self-study, computer-based training (CBT), on-the-job training (OJT), etc.);
- (k) the training material;
- (l) the training schedule;
- (m) the competence assessment method (e.g. pre-course, on-training evaluation, post-course, etc.);
- (n) the record of individual learners training and competence assessment; and
- (o) the feedback mechanisms.

GM2 ATSEP.OR.105 Training and competence assessment programme

ED Decision 2017/001/R

CHANGE OF ORGANISATION

When already qualified and experienced ATSEP move from one service provider to another, the receiving service provider may conduct an analysis and/or competence assessment of their previous training. Any identified training shortcomings, relative to their new duties assignments should be addressed through additional training.

ATSEP.OR.110 Record-keeping

Regulation (EU) 2017/373

In addition to point [ATM/ANS.OR.B.030](#), the service provider employing ATSEP shall maintain records of all the training completed by ATSEP, as well as the competence assessment of ATSEP and make such records available:

- (a) on request, to the ATSEP concerned;
- (b) on request, and with the agreement of the ATSEP, to the new employer when the ATSEP is employed by a new entity.

ATSEP.OR.115 Language proficiency

Regulation (EU) 2017/373

The service provider shall ensure that ATSEP are proficient in the language(s) required to perform their duties.

AMC1 ATSEP.OR.115 Language proficiency

ED Decision 2017/001/R

LANGUAGE LEVEL

Service providers should determine the level of language proficiency based on the particular ATSEP duties, the safety criticality of the system ATSEP will need to work on, and taking into account the language requirements related to operating instructions, manuals, and the need to communicate across operational boundaries that require a common language.

SECTION 2 — TRAINING REQUIREMENTS

ATSEP.OR.200 Training requirements — General

Regulation (EU) 2017/373

A service provider shall ensure that ATSEP:

- (a) have successfully completed:
 - (1) the basic training as set out in point [ATSEP.OR.205](#);
 - (2) the qualification training as set out in point [ATSEP.OR.210](#);
 - (3) the system/equipment rating training as set out in point [ATSEP.OR.215](#);
- (b) have completed continuation training in accordance with point [ATSEP.OR.220](#).

GM1 ATSEP.OR.200 Training requirements — General

ED Decision 2020/020/R

ATSEP TRAINING PHASES

The following diagram illustrates the phases of ATSEP training:

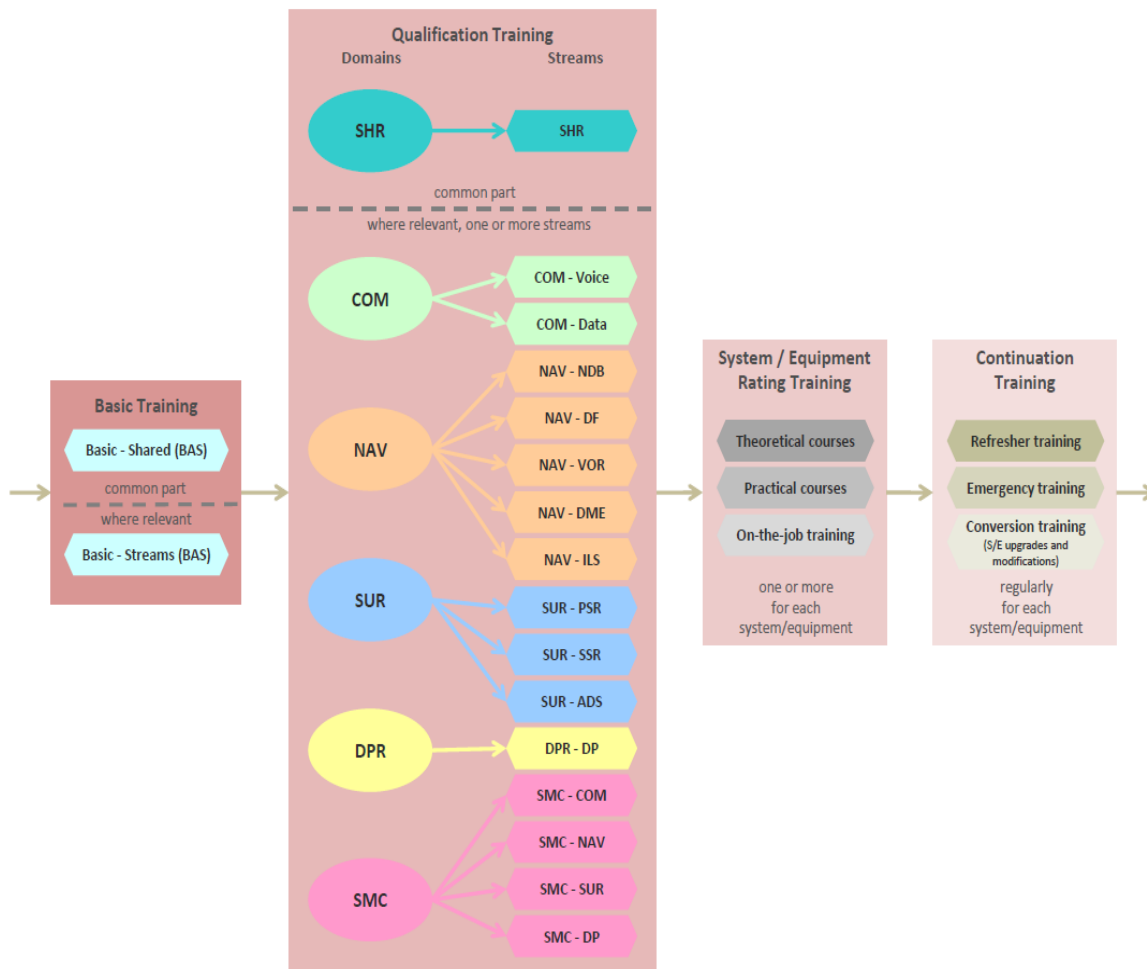

GM2 ATSEP.OR.200 Training requirements — General

ED Decision 2017/001/R

STRUCTURE SYLLABI

Guidance material on how to read the tables in the appendices contained in this Subpart A of ANNEX XIII is provided in Appendix 5a.

GM1 ATSEP.OR.200(a) Training requirements — General

ED Decision 2017/001/R

BASIC TRAINING

For the purpose of this section, ‘basic training’ is understood as being training designed to impart fundamental knowledge of the service provider’s operational environment.

QUALIFICATION TRAINING

For the purpose of this section, ‘qualification training’ is understood as being training designed to impart knowledge and skills appropriate to the qualification stream to be pursued in the service provider’s operational environment.

SYSTEM/EQUIPMENT RATING TRAINING

For the purpose of this section, ‘system/equipment rating training’ is understood as being training designed to impart system/equipment-related knowledge and skills leading towards operational competence.

CONTINUATION TRAINING

For the purpose of this section, ‘continuation training’ is understood as being training designed to maintain and/or augment existing knowledge and skills related to the ATSEP assigned responsibilities and duties.

ATSEP.OR.205 Basic training

Regulation (EU) 2017/373

- (a) The basic training of ATSEPs shall comprise:
 - (1) the subjects, topics, and sub-topics contained in Appendix 1 (Basic training — Shared);
 - (2) where relevant to service provider's activities, the subjects contained in Appendix 2 ([Basic training — Streams](#)).
- (b) A service provider may determine the most suitable educational requirements for its candidate ATSEP and, consequently, adapt the number and/or level of subjects, topics or sub-topics referred to in point (a) where relevant.

GM1 ATSEP.OR.205 Basic training

ED Decision 2017/001/R

MINIMUM TRAINING

The basic training contained within the requirement is the minimum training that needs to be followed by all who aim at becoming ATSEP. However, service providers may decide to add additional subjects or topics that may be specific to their national or local environment.

COMPOSITION OF COURSES

Basic training may be provided as a stand-alone course or as part of a larger initial training course (i.e. basic plus qualification training).

AMC1 ATSEP.OR.205(a) Basic training

ED Decision 2020/020/R

GENERAL

The selection of the subjects, topics, and subtopics should be tailored to:

- (a) the duties of the ATSEP regarding the service provider's activities; and
- (b) prior experience and education of the candidate ATSEP.

AMC1 ATSEP.OR.205(a)(1) Basic training

ED Decision 2017/001/R

SHARED

The objectives contained in Appendix 1a to this AMC should be included in the basic training course.

AMC1 ATSEP.OR.205(a)(2) Basic training

ED Decision 2017/001/R

STREAMS

The topics, sub-topics and objectives contained in Appendix 2a to this AMC should be included in the basic training course.

GM1 ATSEP.OR.205(b) Basic training

ED Decision 2020/020/R

ENTRY LEVEL

In some instances, only a limited number of training objectives will need to be taught to ATSEP learners. This is usually the case when the entry level of learners includes some form of previous qualification (e.g. engineering degree or diploma). In this case, the length of training and the number of objectives may be less than that of a course directed to learners who have little or no engineering or technical qualifications. If no engineering or technical qualifications are required prior to starting the basic training, then it may be necessary to include additional objectives in the training that will prepare learners to deal with the basic training.

ATSEP.OR.210 Qualification training

Regulation (EU) 2017/373

The qualification training of ATSEPs shall comprise:

- (a) the subjects, topics, and sub-topics contained in [Appendix 3](#) (Qualification training — Shared);
- (b) where relevant to its activities, at least one of the qualification streams, contained in [Appendix 4](#) (Qualification training — Streams).

AMC1 ATSEP.OR.210 Qualification training

ED Decision 2020/020/R

GENERAL

The selection of the subjects, topics, and subtopics should be tailored to:

- (a) the duties of the ATSEP regarding the service provider's activities; and
- (b) prior experience and education of the candidate ATSEP.

AMC2 ATSEP.OR.210 Qualification training

ED Decision 2017/001/R

SHARED

The objectives contained in Appendix 3a to this AMC should be included in the qualification training course.

GM1 ATSEP.OR.210 Qualification training

ED Decision 2017/001/R

MINIMUM TRAINING

The qualification training contained within the requirement is the minimum training that needs to be followed by all who aim at becoming ATSEP. However, service providers may decide to add additional subjects or topics that may be specific to their national or local environment.

COMPOSITION OF COURSES

Qualification training may be provided as (a) stand-alone course(s) or as part of a larger course.

AMC1 ATSEP.OR.210(a) Qualification training

ED Decision 2017/001/R

STREAMS

The objectives contained in Appendix 4a to this AMC should be included in the qualification training course.

GM1 ATSEP.OR.210(b) Qualification training

ED Decision 2017/001/R

STREAMS

For the purpose of this section, 'streams' is understood as being a cluster of training objectives that support a particular area of work.

ATSEP.OR.215 System and equipment rating training

Regulation (EU) 2017/373

- (a) The system and equipment rating training of ATSEPs shall be applicable to the duties to be performed and include one or several of the following:
 - (1) theoretical courses;
 - (2) practical courses;
 - (3) on-the-job training.
- (b) The system and equipment rating training shall ensure that candidate ATSEP acquire knowledge and skills pertaining to:
 - (1) the functionality of the system and equipment;
 - (2) the actual and potential impact of ATSEP actions on the system and equipment;
 - (3) the impact of the system and equipment on the operational environment.

GM1 ATSEP.OR.215 System and equipment rating training

ED Decision 2017/001/R

SYSTEM AND EQUIPMENT RATING

A system and equipment rating is the authorisation which allows the ATSEP to perform operational tasks on specific system/equipment and may, optionally, include an association with operational site/s, location/s and/or maintenance task levels. The award of this rating follows the successful assessment of operational competence.

The term 'rating' in the definition of 'system/equipment rating training' should not be associated with the definition of 'rating' in [Regulation \(EC\) No 216/2008](#).

ATSEP.OR.220 Continuation training

Regulation (EU) 2017/373

The continuation training of ATSEPs shall comprise refresher, equipment/systems upgrades and modifications, and/or emergency training.

AMC1 ATSEP.OR.220 Continuation training

ED Decision 2017/001/R

GENERAL

The frequency and duration of continuation training should be determined by taking into account the ATSEP task exposure (recency) as well as the complexity of the operation and of the maintenance of systems.

GM1 ATSEP.OR.220 Continuation training

ED Decision 2017/001/R

REFRESHER TRAINING

- (a) For the purpose of this section, ‘refresher training’ is understood as being training designed to review, reinforce or upgrade existing knowledge and skills (including team skills).
- (b) Refresher training may periodically include training to refresh and augment ATSEP team skills. Team skills include but are not limited to communication, negotiation, decision-making, conflict resolution and listening skills.

EMERGENCY TRAINING

- (c) ‘Emergency training’ is understood as being training designed to broaden knowledge, skills, and behaviour in case of emergency, unusual or degraded situation. Most of the training will be site-specific or may make use of incident or accident analysis.
- (d) The term ‘emergency’ is considered as a serious, unexpected and/or potentially dangerous situation requiring immediate action(s), e.g. complete loss of any of the following:
 - radar display picture;
 - Electronic Flight Progress Strip system;
 - main, standby and emergency communications on multiple frequencies due to external interference blocking the radiotelephony channels.
- (e) The term ‘unusual situation’ is considered as a set of circumstances which are neither habitually nor commonly experienced and for which an ATSEP has not developed a practised response.
- (f) The term ‘degraded situation’ is considered as a situation that is the result of a technical system failure or malfunction or a set of circumstances arising from human error or violation of rules affecting the quality of the service provided (i.e. the service continues to be available, even though in a reduced or limited way). For instance, external main supply’s failure to a Category III ILS localiser field site cabin or a normally dual channel DME having a fault on one channel.

SECTION 3 — COMPETENCE ASSESSMENT REQUIREMENTS

ATSEP.OR.300 Competence assessment — General

Regulation (EU) 2017/373

A service provider shall ensure that ATSEP:

- (a) have been assessed as competent before performing their duties;
- (b) are subject to ongoing competence assessment in accordance with point [ATSEP.OR.305](#).

GM1 ATSEP.OR.300(a) Competence assessment — General

ED Decision 2017/001/R

MEANING

‘Competence’ is understood as a situation where ATSEP possess the required level of knowledge, technical and behavioural skills and experience, and language proficiency when required, in order to be authorised to perform duties on the system and equipment they are competent to work on.

ATSEP.OR.305 Assessment of initial and ongoing competence

Regulation (EU) 2017/373

A service provider employing ATSEP shall:

- (a) establish, implement and document processes for:
 - (1) assessing the initial and ongoing competence of ATSEP;
 - (2) addressing a failure or degradation of ATSEP competence, including an appeal process;
 - (3) ensuring the supervision of personnel who have not been assessed as competent;
- (b) define the following criteria against which initial and ongoing competence shall be assessed:
 - (1) technical skills;
 - (2) behavioural skills;
 - (3) knowledge.

GM1 ATSEP.OR.305(a)(1) Assessment of initial and ongoing competence

ED Decision 2017/001/R

INITIAL COMPETENCE ASSESSMENT

If the competence assessment is done by the same person training the ATSEP learner during the S/E training phase, the service provider should have in place a process to reduce biases.

GM1 ATSEP.OR.305(a)(3) Assessment of initial and ongoing competence

ED Decision 2017/001/R

SUPERVISION OF NON-COMPETENT PERSONNEL

Supervision of personnel for lack of competence may be necessary due to a number of circumstances including but not restricted to:

- (a) the ATSEP still being trained;
- (b) the ATSEP undergoing remedial training due to loss of competence; and
- (c) the ATSEP having lost competence due to extended absence from tasks that require competence.

GM1 ATSEP.OR.305(b)(2) Assessment of initial and ongoing competence

ED Decision 2017/001/R

BEHAVIOURAL SKILLS

Behavioural skills are non-technical skills and attitudes that ATSEP need to perform effectively. Examples of potential behavioural skills criteria related to initial and ongoing competence are:

- (a) cooperation within a team;
- (b) attitudes towards safety and security;
- (c) flexibility;
- (d) analytical thinking; and
- (e) ability to communicate effectively.

SECTION 4 — INSTRUCTORS AND ASSESSORS REQUIREMENTS

ATSEP.OR.400 ATSEP training instructors

Regulation (EU) 2017/373

A service provider employing ATSEP shall ensure that:

- (a) ATSEP training instructors are suitably experienced in the field where instruction is to be given;
- (b) on-the-job training instructors have successfully completed an on-the-job-training course and have the skills to intervene in instances where safety may be compromised during the training.

ATSEP.OR.405 Technical skills assessors

Regulation (EU) 2017/373

A service provider employing ATSEP shall ensure that technical skills assessors have successfully completed an assessor course and are suitably experienced to assess the criteria defined in point [ATSEP.OR.305\(b\)](#).

AMC1 ATSEP.OR.405 Technical-skill assessors

ED Decision 2020/020/R

EXPERIENCE

To be considered suitably experienced, technical skills assessors should:

- (a) have clear understanding of the service provider's assessment process and procedures applicable;
- (b) have clear understanding of the performance required of the ATSEP during the assessment and/or on-going assessment;
- (c) have the ability to evaluate, in an objective and independent manner, whether the ATSEP has achieved or is maintaining the level of performance required;
- (d) have the ability to assess and, if required, act when intervention is necessary to ensure that safety is not compromised;
- (e) have the ability to analyse and accurately describe and/or record strengths and weaknesses of an ATSEP performance; and
- (f) use appropriate interpersonal and communication skills to brief and debrief an ATSEP, if required.

GM1 ATSEP.OR.405 Technical skills assessors

ED Decision 2017/001/R

GENERAL

The technical skills assessor is the person who is considered suitable to determine whether an ATSEP is technically competent to operate, maintain, release from and return into operations systems that are necessary for the provision of services. This assessment may be in any context where assessment of technical skills is required, e.g. assessment of first competence, ongoing competence.

GM2 ATSEP.OR.405 Technical-skill assessors

ED Decision 2020/020/R

ASSESSMENT RESPONSIBILITIES

- (a) Where a technical-skill assessor works regularly with an ATSEP and he or she is required to assess the ATSEP, then continuous assessment may be appropriate, i.e. assessment may be achieved by the technical assessor observing the standard of an ATSEP's work on a continuous basis during normal operational duties. In that case, the technical-skill assessor should inform the ATSEP of when they will be assessed.
- (b) If the appointed technical assessor also acts as line manager to the individual ATSEP, the service provider should have in place a process to reduce biases. Responsibility for determining competence lies with the person having the safety accountability for the ATSEP function.

APPENDICES TO ANNEX XIII

Appendix 1 — Basic training — Shared

Regulation (EU) 2017/373

Subject 1: INDUCTION

TOPIC 1 BASIND — Induction

Sub-topic 1.1 — Training and Assessment Overview

Sub-topic 1.2 — National Organisation

Sub-topic 1.3 — Workplace

Sub-topic 1.4 — ATSEP role

Sub-topic 1.5 — European/Worldwide Dimension

Sub-topic 1.6 — International Standards and Recommended Practices

Sub-topic 1.7 — Data Security

Sub-topic 1.8 — Quality Management

Sub-topic 1.9 — Safety Management System

Sub-topic 1.10 — Health and Safety

Subject 2: AIR TRAFFIC FAMILIARISATION

TOPIC 1 BASATF — Air Traffic Familiarisation

Sub-topic 1.1 — Air Traffic Management

Sub-topic 1.2 — Air Traffic Control

Sub-topic 1.3 — Ground-based Safety Nets

Sub-topic 1.4 — Air Traffic Control Tools and Monitoring Aids

Sub-topic 1.5 — Familiarisation

Appendix 1a — Basic training — Shared

ED Decision 2020/020/R

The subjects, topics and sub-topics are repeated in this AMC for the convenience of the reader and do not form a part of it.

ATSEP UID <i>(Unique Identifier)</i>	Objective	CORPUS	T A X	CONTENT
ATSEP.BAS		ATSEP BASIC		
ATSEP.BAS.IND		INDUCTION		
ATSEP.BAS.IND_1		INDUCTION		
ATSEP.BAS.IND_1.1		Training and Assessment Overview		
ATSEP.BAS.IND_1.1.1	Describe the training scheme and progression towards ATSEP competence		2	Initial (Basic and Qualification), S/E Rating and Continuation training; course aims, objectives, and topics
ATSEP.BAS.IND_1.1.2	State the assessment requirements, procedures, and methods		1	-
ATSEP.BAS.IND_1.2		National Organisation		
ATSEP.BAS.IND_1.2.1	Describe the organisational structure, purpose and functions of the service provider(s) and regulatory structures		2	e.g. headquarters, control centres, training facilities, airports, outstations, civil/military interfaces, regulatory interfaces
ATSEP.BAS.IND_1.2.2	Describe the structure and functions of the major departments within the service provider		2	e.g. organisational handbook (plans, concepts and structure, finance model)
ATSEP.BAS.IND_1.2.3	State appropriate accountabilities and responsibilities of the service provider(s) and competent authority		1	-
ATSEP.BAS.IND_1.3		Workplace		

ATSEP UID <i>(Unique Identifier)</i>	<i>Objective</i> CORPUS	T A X	CONTENT
ATSEP.BAS.IND_1.3.1	State the role of trade unions and professional organisations	1	e.g. international, European, national, local level
ATSEP.BAS.IND_1.3.2	Consider security of site facilities and personnel against unlawful interference	2	Environmental, physical and information security measures, employee vetting, and reference checks
ATSEP.BAS.IND_1.3.3	Describe actions when suspecting a security breach	2	e.g. inform police, security agencies and managers; follow the security manual and/or contingency plan
ATSEP.BAS.IND_1.4	ATSEP Role		
ATSEP.BAS.IND_1.4.1	Describe the key responsibilities of an ATSEP	2	-
ATSEP.BAS.IND_1.5	European/Worldwide Dimension		
ATSEP.BAS.IND_1.5.1	Explain the relationship between States and its relevance to ATM operations	2	e.g. harmonisation, flow management, bilateral agreement, sharing of ATM relevant data, major studies, research programmes, and policy documents
ATSEP.BAS.IND_1.5.2	Define the regulatory framework of international and national ATM	1	e.g. ICAO, European and national concepts, responsibilities
ATSEP.BAS.IND_1.5.3	State the purpose of a range of international bodies	1	ICAO, EU, EASA e.g. ECAC, EUROCONTROL, RTCA, EUROCAE
ATSEP.BAS.IND_1.6	International Standards and Recommended Practices		
ATSEP.BAS.IND_1.6.1	Explain how the regulatory environment of ICAO notifies and implements legislation	2	ICAO Annexes
ATSEP.BAS.IND_1.6.2	State which major/key ATM engineering ‘standards’ and ‘practices’ are applicable	1	e.g. ICAO Annex 10, ICAO Doc 8071, ICAO Doc 9426-3, available EUROCONTROL standards, guidance material on reliability, maintainability and availability

ATSEP UID <i>(Unique Identifier)</i>	<i>Objective</i> CORPUS	T A X	CONTENT
ATSEP.BAS.IND_1.7	Data Security		
ATSEP.BAS.IND_1.7.1	Explain the importance of ATM security	2	-
ATSEP.BAS.IND_1.7.2	Describe the security of operational data	2	Secure, restricted access by authorised personnel
ATSEP.BAS.IND_1.7.3	Explain security policies and practices for information and data	2	Backup, storing, hacking, confidentiality, copyright
ATSEP.BAS.IND_1.7.4	Describe the possible external interventions which may interrupt or corrupt ATM services	2	Introduction of software viruses, illegal broadcasts, jamming, spoofing
ATSEP.BAS.IND_1.8	Quality Management		
ATSEP.BAS.IND_1.8.1	Explain the need for quality management	2	e.g. ISO, EFQM (European Foundation for Quality Management)
ATSEP.BAS.IND_1.8.2	Explain the need for configuration management	2	Importance for safe operations
ATSEP.BAS.IND_1.9	Safety Management System		
ATSEP.BAS.IND_1.9.1	Explain why there is a need for high-level safety requirements for ATM/ANS activities	2	Safety policy and rules, system safety cases, system safety requirements
ATSEP.BAS.IND_1.10	Health and Safety		
ATSEP.BAS.IND_1.10.1	Explain personal safety responsibilities in the work environment	2	Safety statement, first aid, rules about climbing
ATSEP.BAS.IND_1.10.2	Explain potential hazards to health and safety generated by equipment, or contained within the work environment	2	e.g. health consequences of electric shock and static discharges, precautions with chemical products (batteries), mechanical hazards (rotating machinery/antennas), toxic materials (beryllium), biological hazards, faulty earthing

ATSEP UID <i>(Unique Identifier)</i>	<i>Objective</i> CORPUS	T A X	CONTENT
ATSEP.BAS.IND_1.10.3	Describe fire safety and first-aid regulations and practices	2	Requirements and rules e.g. standards
ATSEP.BAS.IND_1.10.4	State any applicable legal requirements and safety rules	1	National, international regulations e.g. for working on power supply and/or air conditioning
ATSEP.BAS.IND_1.10.5	Describe the main features and uses of the different types of fire detectors and extinguishers	2	e.g. VESDA, Type A, B, C, D extinguishers
ATSEP.BAS.ATF	AIR TRAFFIC FAMILIARISATION		
ATSEP.BAS.ATF_1	AIR TRAFFIC FAMILIARISATION		
ATSEP.BAS.ATF_1.1	Air Traffic Management		
ATSEP.BAS.ATF_1.1.1	Define Air Traffic Management	1	ICAO, EU regulations
ATSEP.BAS.ATF_1.1.2	Describe operational ATM functions	2	ATFCM, ATS, ASM
ATSEP.BAS.ATF_1.1.3	Describe ATM concepts and associated terminology	2	e.g. concepts: FUA, free flight, gate-to-gate, performance-based ATM operations (PBN, RCP), operational concepts (ICAO, EUROCONTROL, SESAR)
ATSEP.BAS.ATF_1.1.4	Explain the operational importance of technical services required for ATM	2	e.g. Interoperability
ATSEP.BAS.ATF_1.1.5	State future developments in systems and/or ATM/ANS practices which may have an impact on services provided	1	e.g. data link, satellite-based navigation, gate-to-gate (CDM), ATC tools, continuous approach, 4D trajectory, business trajectory, SWIM, NOP, SESAR (UDPP, modes of separation), ASAS
ATSEP.BAS.ATF_1.1.6	List the standard units of measurement used in aviation	1	Speed, distance, vertical distance, time, direction, pressure, temperature

ATSEP UID <i>(Unique Identifier)</i>	<i>Objective</i> CORPUS	T A X	CONTENT
ATSEP.BAS.ATF_1.2	Air Traffic Control		
ATSEP.BAS.ATF_1.2.1	Define airspace organisation	1	ICAO Annex 11, Regulation (EU) No 923/2012 e.g. FIR, UTA, TMA, CTR, ATS routes
ATSEP.BAS.ATF_1.2.2	Describe commonly used airspace terminologies and concepts	2	e.g. sectorisation, identification of ATS routes, restricted airspace, significant points
ATSEP.BAS.ATF_1.2.3	State the general organisation of aerodromes	1	e.g. obstacle limitation surfaces, different departure and arrival trajectories, approach and landing categories, operational status of radio navigation aids
ATSEP.BAS.ATF_1.2.4	State the purpose of ATC	1	ICAO Doc 4444
ATSEP.BAS.ATF_1.2.5	State the organisation of ATC services	1	ICAO Doc 4444 e.g. area, approach, aerodrome control services
ATSEP.BAS.ATF_1.3	Ground-based Safety Nets		
ATSEP.BAS.ATF_1.3.1	Describe the purpose of ground-based safety nets	2	e.g. STCA, MSAW, APW, runway incursion alerts
ATSEP.BAS.ATF_1.4	Air Traffic Control Tools and Monitoring Aids		
ATSEP.BAS.ATF_1.4.1	Explain the main characteristics and use of ATC support and monitoring tools	2	e.g. MTCD, sequencing and metering tools (AMAN, DMAN), A-SMGCS, CLAM, RAM, CORA
ATSEP.BAS.ATF_1.5	Familiarisation		
ATSEP.BAS.ATF_1.5.1	Take account of the tasks of ATC	2	e.g. simulation, role play, PC, Part Task Trainer, observations in the operational environment
ATSEP.BAS.ATF_1.5.2	Explain the need for good communication, coordination and cooperation between operational staff	2	e.g. handovers, MIL/CIV, planner/tactical, SV Tech (SMC) and SV ATCO, site visit(s) to ATC units

ATSEP UID <i>(Unique Identifier)</i>	<i>Objective</i> CORPUS	T A X	CONTENT
ATSEP.BAS.ATF_1.5.3	Consider the purpose, function and role of various operational stations in respect of ATM-related operations	2	Site visit(s) to ATC units e.g. meteorological services providers, remote sites, airport operations
ATSEP.BAS.ATF_1.5.4	Define the phases of flight	1	Take-off, climb, cruise, descent and initial approach, final approach and landing
ATSEP.BAS.ATF_1.5.5	Recognise the cockpit environment and associated equipment, in relation to ATC	1	Relevant pilot HMI e.g. familiarisation flight or cockpit simulator training (where practicable), antenna
ATSEP.BAS.ATF_1.5.6	Define airborne collision avoidance systems	1	ACAS, EGPWS e.g. TCAS
ATSEP.BAS.AIS	AERONAUTICAL INFORMATION SERVICES		
ATSEP.BAS.AIS_1	AERONAUTICAL INFORMATION SERVICES (AIS)		
ATSEP.BAS.AIS_1.1	Aeronautical Information Services		
ATSEP.BAS.AIS_1.1.1	State the organisation of the AIS	1	-
ATSEP.BAS.AIS_1.1.2	Define the AIP	1	e.g. contents of AIP, AIC and types of publication: AIRAC, non-AIRAC, data collection and preparation, data format, distribution channels, supporting systems and tools
ATSEP.BAS.AIS_1.1.3	Define the aeronautical charting service	1	Types of aeronautical charts, operational use of charts, supporting systems and tools
ATSEP.BAS.AIS_1.1.4	Define the NOTAM services	1	-
ATSEP.BAS.AIS_1.1.5	Define the ATS Reporting Office	1	e.g. purpose of flight plans and other ATS messages, types of flight plans (FPL and RPL), contents of flight plans and other ATS messages, distribution of flight plans and other ATS messages, supporting systems and tools

ATSEP UID <i>(Unique Identifier)</i>	<i>Objective</i> CORPUS	T A X	CONTENT
ATSEP.BAS.AIS_1.1.6	Define the European AIS Database	1	e.g. central single source, validation, redundancy, EAD structure
ATSEP.BAS.AIS_1.1.7	Define procedures for providing Communications, Navigation and Surveillance (CNS) data	1	Information of a permanent nature, information of a temporary nature, status report of NAVAIDs
ATSEP.BAS.MET	METEOROLOGY		
ATSEP.BAS.MET_1	METEOROLOGY (MET)		
ATSEP.BAS.MET_1.1	Introduction to Meteorology		
ATSEP.BAS.MET_1.1.1	State the relevance of meteorology in aviation	1	Influence on the operation of aircraft, flying conditions, aerodrome conditions
ATSEP.BAS.MET_1.1.2	State the weather prediction and measurement systems available	1	wind, visibility, temperature, pressure, humidity, cloud base
ATSEP.BAS.MET_1.2	Impact on Aircraft and ATS Operation		
ATSEP.BAS.MET_1.2.1	State the meteorological conditions and their impact on aircraft operations	1	e.g. wind, visibility, temperature/humidity, clouds, precipitation, pressure, density
ATSEP.BAS.MET_1.2.2	State the meteorological conditions hazardous to aircraft operations	1	e.g. turbulence, thunderstorms, icing, squall, macro bursts, wind shear, contaminated runway
ATSEP.BAS.MET_1.2.3	Explain the impact of meteorological conditions and hazards on ATS operations	2	Increased vertical and horizontal separation, low visibility procedures, anticipation of flights not adhering to tracks, diversions, missed approaches e.g. effects on equipment performance
ATSEP.BAS.MET_1.2.4	Explain the effects of weather on propagation	2	e.g. anaprop, rain noise, sunspots

ATSEP UID <i>(Unique Identifier)</i>	<i>Objective</i> CORPUS	T A X	CONTENT
ATSEP.BAS.MET_1.3	Meteorological Parameters and Information		
ATSEP.BAS.MET_1.3.1	List the main meteorological parameters	1	Wind, visibility, temperature, pressure, humidity
ATSEP.BAS.MET_1.3.2	List the most common weather messages and broadcasts used in aviation	1	Meteorology messages: TAF, METAR, SNOWTAM, SIGMET Broadcasts: ATIS/VOLMET e.g. Regulation (EU) 2017/373 – Annex V (Part-MET)
ATSEP.BAS.MET_1.4	Meteorological Systems		
ATSEP.BAS.MET_1.4.1	Explain the basic principles of the main meteorological systems in use	2	e.g. weather display and information systems, wind speed (anemometer), wind direction (weather vane), visibility (types of IRVR, forward scatter), temperature probes, pressure (aneroid barometers), humidity, cloud base (laser ceilometers)

Appendix 2 — Basic training — Streams

Regulation (EU) 2017/373

Subject 3: AERONAUTICAL INFORMATION SERVICES

Subject 4: METEOROLOGY

Subject 5: COMMUNICATION

Subject 6: NAVIGATION

Subject 7: SURVEILLANCE

Subject 8: DATA PROCESSING

Subject 9: SYSTEM MONITORING & SYSTEM CONTROL

Subject 10: MAINTENANCE PROCEDURES

Appendix 2a — Basic training — Streams

ED Decision 2020/020/R

The subjects, topics and sub-topics are repeated in this AMC for the convenience of the reader and do not form a part of it.

ATSEP UID (Unique Objective Identifier)	CORPUS	T A X	CONTENT
ATSEP.BAS.COM	COMMUNICATION		
ATSEP.BAS.COM_1	GENERAL INTRODUCTION		
ATSEP.BAS.COM_1.1	Introduction to Communications		
ATSEP.BAS.COM_1.1.1	State the structure of the communication domain	1	Voice communication, data communication
ATSEP.BAS.COM_1.1.2	State major substructures of the communication domain	1	Air-ground, ground-ground, air-air communications
ATSEP.BAS.COM_1.1.3	State ATS requirements for safe communications	1	Safety, reliability, availability, coverage, QoS, latency
ATSEP.BAS.COM_1.1.4	State the aeronautical communication services	1	Mobile, fixed
ATSEP.BAS.COM_2	VOICE COMMUNICATION		
ATSEP.BAS.COM_2.1	Introduction to Voice Communications		
ATSEP.BAS.COM_2.1.1	Describe system architecture	2	-
ATSEP.BAS.COM_2.1.2	Explain the purpose, principles and role of voice communication systems in ATS	2	e.g. audio bandwidth, dynamic range, fidelity, routing, switching, lineside/deskside, coverage, communication chain between controller and pilot
ATSEP.BAS.COM_2.1.3	Describe the way in which voice communication systems function	2	VoIP VCS, analogue/digital comparisons, distortion, harmonics
ATSEP.BAS.COM_2.1.4	State methods used to route and switch voice communications	1	e.g. multichannels, multi-users, party lines, VHF/UHF linkage, HF, SELCAL
ATSEP.BAS.COM_2.1.5	State how systems interface to produce an integrated service to ATS	1	-
ATSEP.BAS.COM_2.1.6	State radio spectrum and frequency allocation constraints and procedures	1	Spectrum, interference sources, commercial allocations, world radio conference, ITU, efficient utilisation of frequency bands, channel spacing
ATSEP.BAS.COM_2.1.7	State voice recording systems in use	1	e.g. digital recording equipment

ATSEP.BAS.COM_2.1.8	State ICAO and local legal requirements regarding recording and retention of voice communications	1	Regulatory requirements, incident recording and playback, recording equipment
ATSEP.BAS.COM_2.1.9	State the purpose of ATIS and VOLMET	1	-
ATSEP.BAS.COM_2.2	Air-Ground Communication		
ATSEP UID <i>(Unique Objective Identifier)</i>	CORPUS	T A X	CONTENT
ATSEP.BAS.COM_2.2.1	State the functions and basic operation of routing and switching equipment in use in the ATS environment	1	Voice switching
ATSEP.BAS.COM_2.2.2	Describe the purpose and operation of the elements of a communication chain in use in the ATS environment	2	Functionality, emergency systems, transmission/reception, CWP, on- board equipment e.g. channel spacing, antenna switching, CLIMAX, voting systems
ATSEP.BAS.COM_2.2.3	State ways of achieving quality of service	1	e.g. importance of coverage and redundancy of equipment, overlapping coverage, backup system, functional redundancy vs element redundancy
ATSEP.BAS.COM_2.2.4	Recognise the elements of the CWP that are used for air-ground communication	1	Frequency selection, emergency, station selection, coupling, microphone, headset, loudspeaker, footswitch, Push-To-Talk
ATSEP.BAS.COM_2.2.5	List techniques and future developments which have, or may have an impact on ATS voice communications	1	e.g. CPDLC, VDL Mode 2
ATSEP.BAS.COM_2.3	Ground-Ground Communication		
ATSEP.BAS.COM_2.3.1	State the functions and the basic operations of routing and switching equipment in use in ATS environment	1	General architecture
ATSEP.BAS.COM_2.3.2	Describe how ground-ground systems interface to provide an integrated service to ATS environment	2	International/national links, ACC interoperability, voice and data integration
ATSEP.BAS.COM_2.3.3	Describe the functionality of the elements of a ground-ground communication system	2	Main and emergency systems, interfaces to telecom providers e.g. MFC and ATS-Qsig, switching, local PABX equipment

ATSEP.BAS.COM_2.3.4	Recognise the elements of the CWP used for ground-ground communication	1	Selection, emergency, loudspeaker, headset, microphone
ATSEP.BAS.COM_2.3.5	Describe developments in ground-ground technologies which may impact on ATS voice communication	2	TCP/IP, voice-over IP e.g. protocols future development
ATSEP.BAS.COM_3	DATA COMMUNICATION		
ATSEP.BAS.COM_3.1	Introduction to Data Communication		
ATSEP.BAS.COM_3.1.1	Explain the purpose, principles and role of data communication systems in ATS	2	e.g. terminology, principles and theory of networks, layering (OSI or TCP/IP), data links, LAN, WAN
ATSEP.BAS.COM_3.1.2	Define the concept of data transmission	1	e.g. packet switching, protocols, multiplexing, demultiplexing, error detection and correction, routing, switching, hops, cost, bandwidth/speed
ATSEP.BAS.COM_3.1.3	Describe the function of various elements of the data systems in use in ATS environment	2	Switch, router, gateways, end systems, redundancy
ATSEP UID <i>(Unique Objective Identifier)</i>	CORPUS	T A X	CONTENT
ATSEP.BAS.COM_3.1.4	Define protocols in current use	1	e.g. TCP/IP, frame relay, asynchronous transfer mode
ATSEP.BAS.COM_3.2	Networks		
ATSEP.BAS.COM_3.2.1	State ATS requirements for safe data communications	1	Reliability, availability
ATSEP.BAS.COM_3.2.2	Describe the different types of networks	2	LAN, WAN, ATN, national network for ATM e.g. satellite-dedicated networks, AFTN Priorities, rights
ATSEP.BAS.COM_3.2.3	State the functions of a network management system	1	e.g. SNMP
ATSEP.BAS.COM_3.3	Aviation Specific Networks, Applications and ATM/ANS Providers		

ATSEP.BAS.COM_3.3.1	Name a range of air-ground aviation-related network concepts	1	ATN e.g. Subnetworks: ATN air-ground subnetwork, AMSS, VDL, HFDL Protocols: ACARS Communication service providers: ARINC, SITA
ATSEP.BAS.COM_3.3.2	Name a range of ground-ground aviation-related network concepts	1	ATN, PENS e.g. Physical networks: PENS, AFTN, RAPNET Communication protocols: IP, ASTERIX, FMTP Communication service providers: SITA, ARINC, national carriers, ANSPs Applications: AMHS, AIDC, OLDI
ATSEP.BAS.COM_3.3.3	Define SWIM	1	SWIM institutional framework and applications e.g. SWIM providers and users
ATSEP.BAS.NAV	NAVIGATION		
ATSEP.BAS.NAV_1	INTRODUCTION		
ATSEP.BAS.NAV_1.1	Purpose and Use of Navigation		
ATSEP.BAS.NAV_1.1.1	Explain the need for navigation in aviation	2	Positioning, guidance, planning
ATSEP.BAS.NAV_1.1.2	Characterise navigation methods	2	e.g. historical overview, visual, celestial, electronic (on-board, radio, space-based and relative)
ATSEP.BAS.NAV_2	THE EARTH		
ATSEP.BAS.NAV_2.1	Form of the Earth		
ATSEP.BAS.NAV_2.1.1	State the shape of the Earth and its parameters	1	Oblate spheroid e.g. diameter, gravity, rotation, axis, magnetic field
ATSEP.BAS.NAV_2.1.2	Explain the Earth's properties and their effects	2	Polar axis, direction of rotation
ATSEP.BAS.NAV_2.1.3	State the accepted conventions for describing 2D position on a globe	1	Meridians, parallels of latitude, equatorial plane
ATSEP.BAS.NAV_2.2	Coordinate Systems, Direction and Distance		

ATSEP.BAS.NAV_2.2.1	State the general principles of reference systems	1	Geoid, reference ellipsoids, WGS 84 Latitude and longitude, undulation
ATSEP UID <i>(Unique Objective Identifier)</i>	CORPUS	T A X	CONTENT
ATSEP.BAS.NAV_2.2.2	Explain why a global reference system is required for aviation	2	-
ATSEP.BAS.NAV_2.3	Earth's Magnetism		
ATSEP.BAS.NAV_2.3.1	State the general principles of Earth's magnetism	1	True North, magnetic North e.g. variation, declination, deviation, inclination
ATSEP.BAS.NAV_3	NAVIGATIONAL SYSTEM PERFORMANCE		
ATSEP.BAS.NAV_3.1	Factors Affecting Electronic Navigation Performance		
ATSEP.BAS.NAV_3.1.1	State how radio waves propagate	1	Ground, sky, line of sight
ATSEP.BAS.NAV_3.1.2	State why the siting of a terrestrial navigation aid is important	1	Multipath, blanking
ATSEP.BAS.NAV_3.2	Performance of Navigation Systems		
ATSEP.BAS.NAV_3.2.1	State the performance of navigation systems	1	Coverage, accuracy, integrity, continuity of service, availability
ATSEP.BAS.NAV_3.2.2	Explain the need for redundancy in navigation systems	2	Ensuring continuity of service, maintainability, reliability
ATSEP.BAS.NAV_3.3	Means of Navigation		
ATSEP.BAS.NAV_3.3.1	State the different means of navigation	1	Sole, primary, supplementary
ATSEP.BAS.NAV_4	NAVIGATION SYSTEMS		
ATSEP.BAS.NAV_4.1	Terrestrial Navigation Aids		

ATSEP.BAS.NAV_4.1.1	Explain the basic working principles of electronic positioning	2	Distance measurements (time and phase), angular measurements
ATSEP.BAS.NAV_4.1.2	Describe ground-based navigation systems	2	NDB, VOR, DME, ILS, DF e.g. TACAN, marker beacons
ATSEP.BAS.NAV_4.1.3	Recognise how the navigation information is displayed on the relevant pilot HMI	1	-
ATSEP.BAS.NAV_4.1.4	Explain the operational use of ground-based navigation systems in the different phases of flight	2	NDB, VOR, DME, ILS, DF
ATSEP.BAS.NAV_4.1.5	Recognise the frequency bands used by the ground-based navigation systems	1	-
ATSEP.BAS.NAV_4.1.6	State the need for calibration	1	Flight calibration, ground-based calibration and/or maintenance
ATSEP.BAS.NAV_4.2	On-board Navigation Systems		
ATSEP.BAS.NAV_4.2.1	State the use of on-board navigation systems	1	e.g. barometric altimetry, radio altimetry, INS/IRS, compass
ATSEP.BAS.NAV_4.2.2	State the use of an FMS	1	Sensors, navigation database
ATSEP.BAS.NAV_4.3	Space-based Navigation Systems		
ATSEP.BAS.NAV_4.3.1	Explain the basic working principles of satellite positioning	2	GNSS e.g. Galileo, GPS
ATSEP UOID <i>(Unique Objective Identifier)</i>	CORPUS	T A X	CONTENT
ATSEP.BAS.NAV_4.3.2	Recognise the basic architecture of a core satellite positioning system	1	GNSS e.g. Galileo, GPS
ATSEP.BAS.NAV_4.3.3	Recognise the frequency bands used by the space-based navigational systems	1	-

ATSEP.BAS.NAV_4.3.4	State the benefits of satellite-based navigation	1	Global coverage, accuracy, time dissemination e.g. redundancy, interoperability, single set of avionics
ATSEP.BAS.NAV_4.3.5	State the current limitations of space-based navigation systems	1	e.g. single frequency, weak signal, ionospheric delay, institutional, military, multipath
ATSEP.BAS.NAV_4.3.6	Describe the basic working principles of satellite augmentation	2	ABAS (RAIM, AAIM), SBAS (WAAS, EGNOS), GBAS
ATSEP.BAS.NAV_4.3.7	State the current implementations of satellite-based navigation systems	1	Core systems: GPS, GLONASS, GALILEO , BEIDOU, Augmentation systems: RAIM, AAIM, EGNOS, WAAS, GBAS
ATSEP.BAS.NAV_5	PERFORMANCE-BASED NAVIGATION (PBN)		
ATSEP.BAS.NAV_5.1	PBN		
ATSEP.BAS.NAV_5.1.1	Describe the performance based navigation concept	2	ICAO Doc 9613
ATSEP.BAS.NAV_5.1.2	List the navigation applications in use in Europe	1	RNAV-5 (B-RNAV), RNAV-1 (P-RNAV), RNP approaches
ATSEP.BAS.NAV_5.2	Current Developments		
ATSEP.BAS.NAV_5.2.1	State current navigation developments	1	e.g. 4D-RNAV, free routes, rationalisation plans, advanced RNP
ATSEP.BAS.SUR	SURVEILLANCE		
ATSEP.BAS.SUR_1	INTRODUCTION TO SURVEILLANCE		
ATSEP.BAS.SUR_1.1	Introduction to Surveillance		
ATSEP.BAS.SUR_1.1.1	Define surveillance in the context of ATM	1	What (positioning/identification) and why (maintain separation)
ATSEP.BAS.SUR_1.1.2	Define the various surveillance domains	1	Air-air, ground-air, ground-ground
ATSEP.BAS.SUR_1.1.3	List the surveillance techniques	1	Non-cooperative, cooperative, dependent, independent techniques

ATSEP.BAS.SUR_1.1.4	Define the current and emerging surveillance systems in use in ATM	1	Radar technology, ADS technology, multilateration e.g. TIS
ATSEP.BAS.SUR_1.1.5	Explain the role and the current use of surveillance equipment by ATM	2	Separation, vectoring, data acquisition Detection and ranging, safety nets e.g. weather mapping
ATSEP.BAS.SUR_1.1.6	State ICAO and any local legal requirements	1	e.g. ICAO Annex 10 Vol. IV
ATSEP.BAS.SUR_1.1.7	List the main users of surveillance data	1	HMI, safety nets, FDPS, air defence systems, flow management
ATSEP.BAS.SUR_1.2	Avionics		
ATSEP.BAS.SUR_1.2.1	State the avionics used for the surveillance in ATM and their interdependencies	1	Transponder, GNSS, data link equipment, ACAS, ATC control panel e.g. FMS
ATSEP UID <i>(Unique Objective Identifier)</i>	CORPUS	T A X	CONTENT
ATSEP.BAS.SUR_1.2.2	Define the role of TCAS as a safety net	1	e.g. FMS
ATSEP.BAS.SUR_1.3	Primary Radar		
ATSEP.BAS.SUR_1.3.1	Describe the need for and the use of primary radar in ATC	2	Non-cooperative detection, improvement of detection and tracking e.g. types of PSR (en-route, terminal, SMR, weather)
ATSEP.BAS.SUR_1.3.2	Explain the principles of operation, basic elements and overall architecture of a primary radar	2	Detection, range measurement, azimuth indication, Doppler shift, antenna system, TX/RX, signal processing, plot extraction, local tracking, data transmission e.g. use of the parameters of the radar equation
ATSEP.BAS.SUR_1.3.3	State the limitations of primary radar	1	Line of sight, environmental, clutter, no identification of the target, no height information (in case of 2D radar)
ATSEP.BAS.SUR_1.4	Secondary Radar		

ATSEP.BAS.SUR_1.4.1	Describe needs for and the use of secondary radars in ATC	2	Cooperative detection, ICAO-defined standard, IFF, military and civil modes (include Mode S) and related code protocols, code limitations e.g. identification, SPI, flight level, BDS, specific and emergency codes
ATSEP.BAS.SUR_1.4.2	Explain the principles of operation, basic elements and overall architecture of a secondary radar	2	SSR, MSSR, Mode S antenna, TX/RX, extractor, tracking processor e.g. use of the parameters of the radar equation
ATSEP.BAS.SUR_1.4.3	State the limitations of secondary radar	1	FRUIT, garbling, ghost reply, code shortage, cooperation by the aircraft needed
ATSEP.BAS.SUR_1.5	Surveillance Data Message Format		
ATSEP.BAS.SUR_1.5.1	State the need for harmonisation	1	Surveillance data sharing, interoperability
ATSEP.BAS.SUR_1.5.2	State the techniques used for transmission of surveillance data	1	e.g. point-to-point, network, microwave, satellite
ATSEP.BAS.SUR_1.5.3	State main formats in use	1	ASTERIX, etc.
ATSEP.BAS.SUR_1.6	Automatic Dependent Surveillance (ADS)		
ATSEP.BAS.SUR_1.6.1	State surveillance-related FANS concepts and their impact on ATM	1	Sources of aircraft parameters (e.g. FMS outputs), communication mediums Application within oceanic and other non-radar airspace, ATC requirements
ATSEP.BAS.SUR_1.6.2	Explain the principles of operation, basic elements and overall architecture of ADS-C and ADS-B and the differences between them	2	Advantages/disadvantages, standards, data update rates
ATSEP.BAS.SUR_1.6.3	State the data link technologies proposed and the current situation of deployment	1	Extended squitter 1 090 MHz e.g. VDL 4, HFDL, UAT, AMSS

ATSEP UID (Unique Objective Identifier)	CORPUS	TAX	CONTENT
ATSEP.BAS.SUR_1.7	Weather Radar		
ATSEP.BAS.SUR_1.7.1	Define the use of weather radar in ATM	1	e.g. role in adverse weather in dense airspace, antenna, coverage, polarisation, multi-elevation scanning, frequency band
ATSEP.BAS.SUR_1.8	Integration of Surveillance Information		
ATSEP.BAS.SUR_1.8.1	Describe complementary use of different sensors	2	-
ATSEP.BAS.SUR_1.9	Multilateration (MLAT)		
ATSEP.BAS.SUR_1.9.1	State the use of MLAT in ATC	1	LAM and WAM
ATSEP.BAS.SUR_1.9.2	Explain the principles of operation, basic elements and overall architecture of MLAT	2	TDOA principle, hyperbolic positioning, accuracy, transmissions used
ATSEP.BAS.SUR_1.10	Airport Surface Surveillance		
ATSEP.BAS.SUR_1.10.1	State typical ATC requirements	1	e.g. safety (aircraft and mobiles), clear runway, low visibility, collision warnings, displays, mapping, data merging, aircraft identification, ground mobiles
ATSEP.BAS.SUR_1.10.2	State the current technologies for airport surface surveillance	1	Radar-based and MLAT-based technologies, example layout of airport surveillance infrastructure e.g. other systems (acoustic, vibration, induction loop, video, infrared, GNSS, ADS-B)
ATSEP.BAS.SUR_1.11	Display of Surveillance Information		
ATSEP.BAS.SUR_1.11.1	Recognise surveillance information on a display	1	e.g. PSR and MSSR tracks, position identification, FL, speed vector, RDP and FDP information
ATSEP.BAS.SUR_1.12	Analysis Tools		

ATSEP.BAS.SUR_1.12.1	State analysis tools	1	e.g. SASS-C, SASS-S, RAPS
ATSEP.BAS.DPR	DATA PROCESSING		
ATSEP.BAS.DPR_1	DATA PROCESSING		
ATSEP.BAS.DPR_1.1	Introduction to Data Processing		
ATSEP.BAS.DPR_1.1.1	Describe the functions and generic architecture of the systems	2	Generic FDP and SDP overall functional block diagrams
ATSEP.BAS.DPR_1.1.2	Describe how the systems interface with other systems	2	Surveillance sensors, displays, NMOC, recording, international ATM networks e.g. safety nets, military interfaces
ATSEP.BAS.DPR_1.1.3	Define basic software functions/applications	1	FDP (IFPS, route processing, code/call sign correlation, code allocation, strip distribution, track labelling) SDP (coordinate conversion, plot and track processing, MRP, safety nets, track labelling)
ATSEP UOID <i>(Unique Objective Identifier)</i>	CORPUS	T A X	CONTENT
ATSEP.BAS.DPR_1.1.4	State the legal aspects for data processing in ATM	1	Traceability and recording of data and actions, configuration control
ATSEP.BAS.DPR_1.1.5	State current developments and future possibilities	1	e.g. Coflight, iTEC, SESAR, multisensor tracking, SWIM, flight object
ATSEP.BAS.DPR_1.2	System Software and Hardware Principles		
ATSEP.BAS.DPR_1.2.1	Describe the current hardware configurations used in ATM	2	Redundancy and backup e.g. driver, interfaces, hardware platforms, fault tolerant systems
ATSEP.BAS.DPR_1.2.2	Describe the current software platforms, used in ATM	2	Operating systems

ATSEP.BAS.DPR_1.2.3	Describe concepts of virtualisation in ATM	2	Virtual Centre (Remote CWP - SESAR) e.g. display virtualisation (RDU: Remote Display Unit), server virtualisation (server consolidation)
ATSEP.BAS.DPR_1.3	Surveillance Data Processing (SDP)		
ATSEP.BAS.DPR_1.3.1	State ATC requirements	1	QoS, mandatory data recording, dependability
ATSEP.BAS.DPR_1.3.2	Explain the principles of SDP	2	e.g. single, multi, plot, track
ATSEP.BAS.DPR_1.3.3	Describe the functions of SDP	2	Plot processing, tracking, single sensor and multisensor tracker (e.g. radar, ADS, MLAT), estimating limits and accuracy of multisensor tracker, recording e.g. ARTAS tracker
ATSEP.BAS.DPR_1.3.4	Describe radar data inputs/outputs	2	Tracks, plots, messages, code/call sign, time, control and monitoring, conflict alerts, FDP interface, maps, adaptation
ATSEP.BAS.DPR_1.3.5	Describe the surveillance data-based monitoring functions	2	Safety nets, ATC tools e.g. safety nets: STCA, MSAW, APW, runway incursion alerts ATC Tools: MTCD, AMAN, DMAN, A-SMGCS
ATSEP.BAS.DPR_1.4	Flight Data Processing (FDP)		
ATSEP.BAS.DPR_1.4.1	State ATC requirements	1	QoS, unambiguous, accurate, error free, timely
ATSEP.BAS.DPR_1.4.2	Explain the functions of FDP	2	Flight strip production, flight plan data updates, code/call sign correlation, flight progress monitoring, coordination and transfer e.g. CIV/MIL coordination
ATSEP.BAS.DPR_1.4.3	Define inputs and outputs	1	Flow control (NMOC/IFPS/FMP, ETFMS), flight strips/data displays, MRT, environmental data, static data, airspace adaptation
ATSEP.BAS.DPR_1.4.4	Describe the basic software functions/applications	2	FDP (IFPS, route processing, code/call sign correlation, code allocation, strip distribution, track labelling)
ATSEP.BAS.DPR_1.4.5	Describe the FPL data update process	2	Automatic and manual update

ATSEP.BAS.DPR_1.5	Human Machine Interface (HMI)		
ATSEP UID (Unique Objective Identifier)	CORPUS	T A X	CONTENT
ATSEP.BAS.DPR_1.5.1	Describe the different display technologies and interfaces	2	Common graphic display interface, LCD, TFT, Touch Input Device, video interfaces, extenders e.g. DVI, HDMI, DisplayPort, Thunderbolt, video and USB signal extenders, video splitters and video frame rate encoders
ATSEP.BAS.DPR_1.5.2	Recognise what information is normally displayed on the ATCO and ATSEP HMI	1	-
ATSEP.BAS.DPR_1.6	Miscellaneous Information		
ATSEP.BAS.DPR_1.6.1	State the additional data used by ATM system	1	e.g. MET, AIM (NOTAMs), CDM, aircraft data
ATSEP.BAS.SMC	SYSTEM MONITORING AND CONTROL		
ATSEP.BAS.SMC_1	SYSTEM MONITORING AND CONTROL (SMC)		
ATSEP.BAS.SMC_1.1	Overview of SMC Function		
ATSEP.BAS.SMC_1.1.1	Describe the principles and purpose of the operational management of the technical services	2	Service requirements, interfaces, boundaries of tactical responsibility e.g. hierarchy of authority for the technical and ATC structures
ATSEP.BAS.SMC_1.1.2	Describe the technical system architecture of the SMC function and its subordinate systems	2	Main monitoring and control architecture e.g. Surveillance: Radar stations, communications, processing, display Communication: TX/RX, circuit management, networks, HMI, standby facilities, recording Navigation: NDB, VOR, ILS, DF

			Facilities: Power, generators, UPS, battery, environmental (heating, cooling), fire and security DP: FDPS, data communications
ATSEP.BAS.SMC_1.1.3	Describe the transfer of responsibility for a service	2	Operational and technical responsibility Configuration and monitoring access and responsibility
ATSEP.BAS.SMC_1.2	System Configuration		
ATSEP.BAS.SMC_1.2.1	Describe the range of configurations that can be used	2	Equipment or channel switching, parameter settings
ATSEP.BAS.SMC_1.2.2	Describe the general techniques that are employed to make configuration changes	2	e.g. physical switching
ATSEP.BAS.SMC_1.2.3	State procedures required to implement a planned major system change	1	e.g. safety requirement, authorisation, coordination, implementation plan, fallback strategies, major system change, activation of new version of software in a subordinate system, transfer of a service to a new system, change of a database
ATSEP.BAS.SMC_1.3	Monitoring and Control Functions		
ATSEP UID (Unique Objective Identifier)	CORPUS	T A X	CONTENT
ATSEP.BAS.SMC_1.3.1	State the monitoring functions that are available	1	e.g. BITE, status, parameters, software and hardware watchdogs
ATSEP.BAS.SMC_1.3.2	State the control functions that are available	1	e.g. switching, parameters, set configurations
ATSEP.BAS.SMC_1.3.3	Explain the importance of SMC management and coordination of maintenance activities	2	-

ATSEP.BAS.SMC_1.3.4	State analysis tools associated with SMC	1	e.g. possible malfunctions (SASS-C, SASS-S, RAPS, track and noise monitoring tools)
ATSEP.BAS.SMC_1.4	Coordination and Reporting		
ATSEP.BAS.SMC_1.4.1	State why coordination and reporting is required and how it is achieved	1	Facility interrupts, deconflict multiple outages, legal requirements e.g. causes: service failure, planned outage, loss of backup, software upgrade Relevant parties: external service providers, ATC, other centres Relevant information: NOTAM, logbook
ATSEP.BAS.SMC_1.5	Emergency Coordination		
ATSEP.BAS.SMC_1.5.1	Describe situations where coordination and reporting will be necessary	2	e.g. hijack, mayday, R/T fail, loss of aircraft, MIL action, fire, flood, security, terrorist threat or action, medical
ATSEP.BAS.SMC_1.5.2	State which parties may be involved in the coordination and reporting of emergency situations	1	e.g. ATC supervisors (local and remote), ATSEP supervisors (local and remote), management, police, MIL, medical, accident investigation branch
ATSEP.BAS.SMC_1.5.3	Explain the responsibilities and/or duties of SMC members during an emergency situation by using an example scenario	2	-
ATSEP.BAS.SMC_1.5.4	State the succession of authorities and responsibilities in the event that the nominated person or function is not available	1	Hierarchy of responsibility
ATSEP.BAS.SMC_1.6	Equipment Operating		
ATSEP.BAS.SMC_1.6.1	Define the principles and ergonomics of the HMI of the SMC central system and its subordinate systems	1	Permissions, control tokens, ergonomic conventions (e.g. green is good or safe, red is fail or unsafe)
ATSEP.BAS.SMC_1.6.2	State the routine tasks required and the criticality of their completion and any legal requirements	1	e.g. audio circuit voice checking, audio recording checking, archive media changing and storage, VOLMET
ATSEP.BAS.MTN	MAINTENANCE PROCEDURES		

ATSEP.BAS.MTN_1	MAINTENANCE PROCEDURES		
ATSEP.BAS.MTN_1.1	Maintenance Procedures		
ATSEP.BAS.MTN_1.1.1	Explain handling precautions to be taken to ensure equipment protection	2	Isolation, protection devices, electrostatic sensitive devices, power supplies, heavy loads, high voltage
ATSEP UOID <i>(Unique Objective Identifier)</i>	CORPUS	T A X	CONTENT
ATSEP.BAS.MTN_1.1.2	Explain the classifications of maintenance	2	e.g. preventative, corrective, service configuration
ATSEP.BAS.MTN_1.1.3	Explain the maintenance strategy and rules	2	Organisation and planning of maintenance, rules controlling deviation from planned maintenance, intervention tracking, return to service
ATSEP.BAS.MTN_1.1.4	State the scope or responsibility of an S/E rated person	1	e.g. tracing maintenance actions and objectives, liability of maintenance personnel actions, safety of service, safety of equipment
ATSEP.BAS.FAC	FACILITIES		
ATSEP.BAS.FAC_1	FACILITIES		
ATSEP.BAS.FAC_1.1	Power Supply Systems		
ATSEP.BAS.FAC_1.1.1	Define the performance for power supply systems in the operational environment	1	Availability, quality, Continuity of Service
ATSEP.BAS.FAC_1.1.2	Define the main features of current power supply systems	1	e.g. UPS systems, batteries and emergency generators, high voltage, earthing techniques, power provider(s)
ATSEP.BAS.FAC_1.1.3	Describe the power distribution system at an example operational site	2	e.g. power distribution redundancy, input, output, protections, measurements and monitoring, block schematic
ATSEP.BAS.FAC_1.2	Air Conditioning Systems		

ATSEP.BAS.FAC_1.2.1	State the function, appropriate terminology and performance of current air conditioning systems in use	1	e.g. air conditioning, water cooling, humidity control, air filtering system, visit to stations
ATSEP.BAS.FAC_1.2.2	State the importance and criticality of maintaining a controlled environment	1	Short- and long-term effect on people and equipment

Appendix 3 — Qualification training — Shared

Regulation (EU) 2017/373

Subject 1: SAFETY

TOPIC 1 — Safety Management

- Sub-topic 1.1 — Policy and Principles
- Sub-topic 1.2 — Concept of Risk and Principles of Risk Assessment
- Sub-topic 1.3 — Safety Assessment Process
- Sub-topic 1.4 — Air Navigation System Risk Classification Scheme
- Sub-topic 1.5 — Safety Regulation

Subject 2: HEALTH AND SAFETY

TOPIC 1 — Hazard Awareness and Legal Rules

- Sub-topic 1.1 — Hazard Awareness
- Sub-topic 1.2 — Regulations and Procedures
- Sub-topic 1.3 — Handling of Hazardous Material

Subject 3: HUMAN FACTORS

TOPIC 1 — Introduction to Human Factors

- Sub-topic 1.1 — Introduction

TOPIC 2 — Working Knowledge and Skills

- Sub-topic 2.1 — ATSEP knowledge, skills and competence

TOPIC 3 — Psychological Factors

- Sub-topic 3.1 — Cognition

TOPIC 4 — Medical

- Sub-topic 4.1 — Fatigue
- Sub-topic 4.2 — Fitness
- Sub-topic 4.3 — Work Environment

TOPIC 5 — Organisational and Social Factors

- Sub-topic 5.1 — Basic Needs of People at Work
- Sub-topic 5.2 — Team Resource Management
- Sub-topic 5.3 — Teamwork and Team Roles

TOPIC 6 — Communication

- Sub-topic 6.1 — Written Report
- Sub-topic 6.2 — Verbal and Non-verbal Communication

TOPIC 7 — Stress

- Sub-topic 7.1 — Stress
- Sub-topic 7.2 — Stress Management

TOPIC 8 — Human Error

Sub-topic 8.1 — Human Error

Appendix 3a — Qualification training — Shared

ED Decision 2020/020/R

The subjects, topics and sub-topics are repeated in this AMC for the convenience of the reader and do not form a part of it.

ATSEP UID <i>(Unique Identifier)</i>	<i>Objective</i> CORPUS	T A X	CONTENT
ATSEP.QLF.SHR	ATSEP QUALIFICATION DOMAIN - SHARED		
ATSEP.QLF.SHR.SAF	SAFETY		
ATSEP.QLF.SHR.SAF_1	SAFETY MANAGEMENT		
ATSEP.QLF.SHR.SAF_1.1	Policies and Principles		
ATSEP.QLF.SHR.SAF_1.1.1	Explain the underlying need for safety management policies and principles	2	ICAO Annex 19, lessons learnt from events, evolving environment, requirements
ATSEP.QLF.SHR.SAF_1.1.2	State the safety management policy	1	ICAO Annex 19, priority of safety, the safety objective of ATM, roles and responsibilities
ATSEP.QLF.SHR.SAF_1.1.3	Explain safety management principles	2	ICAO Annex 19, safety achievement, safety assurance, safety promotion
ATSEP.QLF.SHR.SAF_1.1.4	Differentiate the reactive and proactive nature of safety management policy and principles	3	e.g. ICAO Annex 19, nature of events, Swiss Cheese Model (J. Reason), events investigation, safety assessment
ATSEP.QLF.SHR.SAF_1.1.5	Explain the link between safety management principles and the life cycle of an ATM system	2	ICAO Annex 19, safety occurrences, setting of safety levels, system safety assessment, safety surveys, safety monitoring, system safety assessment documentation, lesson dissemination, safety improvement, use of safety data to assist in decommissioning or replacement of system

ATSEP UID <i>(Unique Identifier)</i> <i>Objective</i>	CORPUS	T A X	CONTENT
ATSEP.QLF.SHR.SAF_1.1.6	Appreciate the ATSEP role and responsibilities to safety management	3	Competency, occurrence reporting
ATSEP.QLF.SHR.SAF_1.1.7	State the role and content of a typical SMS within an ANSP	1	ICAO Annex 19
ATSEP.QLF.SHR.SAF_1.1.8	Explain the ‘just culture’ concept	2	Benefits, prerequisites, constraints
ATSEP.QLF.SHR.SAF_1.2	Concept of Risk and Principles of Risk Assessment		
ATSEP.QLF.SHR.SAF_1.2.1	Describe the concept of risk	2	Types of risk, components of risk, risk contributors (people, procedure, organisations and equipment)
ATSEP.QLF.SHR.SAF_1.2.2	State ways of assessing risk	1	Risk comparisons, risk analysis
ATSEP.QLF.SHR.SAF_1.2.3	Describe the concept of risk tolerability	2	Risk assessment and mitigation, ALARP Principle e.g. Risk perception, risk management
ATSEP.QLF.SHR.SAF_1.3	Safety Assessment Process		
ATSEP.QLF.SHR.SAF_1.3.1	Explain the methods for the assessment of hazards and possible failures	2	e.g. Failure and hazard brainstorm session, Fault tree analysis
ATSEP.QLF.SHR.SAF_1.3.2	Characterise the importance of adopting a total system approach covering human, procedure, organisation and equipment elements	2	ATM system description (including scope definition and limitation), end-to-end integrity of safety assessment e.g. Concept of TRM
ATSEP.QLF.SHR.SAF_1.3.3	Describe the overall safety assessment process and its relationships with risk assessment during the total life cycle of ANS system	2	Collection and presentation of results, contingency arrangements, back-up procedures e.g. Risk-based process, FHA, (safety objectives), preliminary system safety assessment PSSA (safety requirements), system safety assessment SSA (safety monitoring and evidence)

ATSEP UID <i>(Unique Identifier)</i>	<i>Objective</i> CORPUS	T A X	CONTENT
ATSEP.QLF.SHR.SAF_1.4	Air Navigation System Risk Classification Scheme		
ATSEP.QLF.SHR.SAF_1.4.1	Describe the ATM system risk classification scheme	2	e.g. Scenario of failure of air navigation system (incident chain), component of a risk classification scheme, severity classes, probability classes (qualitative and quantitative)
ATSEP.QLF.SHR.SAF_1.5	Safety Regulation		
ATSEP.QLF.SHR.SAF_1.5.1	Describe the role of safety regulation	2	The purpose of European (EASA, EU) regulations and international standards, objective of the national regulator
ATSEP.QLF.SHR.SAF_1.5.2	Explain the relationship between the safety regulation documents	2	ICAO documentation (SARPS), EASA/EU Regulations, AMCs and GM, national regulation
ATSEP.QLF.SHR.SAF_1.5.3	Explain how the safety regulation documents affect ATM service provision	2	ICAO documentation (SARPS), EASA/EU Regulations, AMCs and GM, national regulation
ATSEP.QLF.SHR.SAF_1.5.4	Explain the interface between the safety regulator and the ANSP	2	Information to be provided to regulator by ANSP and vice versa, importance of incident reporting
ATSEP.QLF.SHR.HAS	HEALTH AND SAFETY		
ATSEP.QLF.SHR.HAS_1	HAZARD AWARENESS AND LEGAL RULES		
ATSEP.QLF.SHR.HAS_1.1	Hazard Awareness		
ATSEP.QLF.SHR.HAS_1.1.1	Consider potential hazards to health and safety generated by equipment used in the functional system	2	e.g. mechanical hazards, electrical hazards (LV, HV, EMI), chemical hazards DP: none
ATSEP.QLF.SHR.HAS_1.2	Regulations and Procedures		

ATSEP UID <i>(Unique Identifier)</i>	<i>Objective</i>	CORPUS	T A X	CONTENT
ATSEP UID <i>(Unique Identifier)</i>	<i>Objective</i>	CORPUS	T A X	CONTENT
ATSEP.QLF.SHR.HAS_1.2.1	State applicable international requirements		1	e.g. European and industry standards
ATSEP.QLF.SHR.HAS_1.2.2	State any applicable national requirements		1	-
ATSEP.QLF.SHR.HAS_1.2.3	Describe safety procedures or measures for persons working on or near relevant equipment and generally in working environment		2	e.g. Protection and isolation (clothing, tools), fire extinguisher types, safety man presence, safety interlocks, isolating switches, security of the site, climbing procedures, earthing, direct or indirect contact with HV
ATSEP.QLF.SHR.HAS_1.3	Handling of Hazardous Material			
ATSEP.QLF.SHR.HAS_1.3.1	State European and local regulations for electronic device disposal		1	Protection of environment e.g. WEEE (Directive 2012/19/EU), ROHS (Directive 2011/65/EU) and other corresponding European Regulations
ATSEP.QLF.SHR.HUF	HUMAN FACTORS			
ATSEP.QLF.SHR.HUF_1	INTRODUCTION TO HUMAN FACTORS			
ATSEP.QLF.SHR.HUF_1.1	Introduction			
ATSEP.QLF.SHR.HUF_1.1.1	Explain why human factors are particularly important in the ATM environment		2	Historical background, safety impact on ATM, incidents
ATSEP.QLF.SHR.HUF_1.1.2	Define human factors		1	e.g. ICAO Human Factors Training Manual

ATSEP UID <i>(Unique Identifier)</i>	Objective CORPUS	T A X	CONTENT
ATSEP.QLF.SHR.HUF_1.1.3	Explain the concept of systems and its relevance in the ATM environment	2	People, procedures, equipment
ATSEP.QLF.SHR.HUF_1.1.4	Explain the use of the SHELL model	2	e.g. ICAO Human Factors Training Manual, visits to OPS and technical rooms
ATSEP.QLF.SHR.HUF_1.1.5	State the factors which can affect personal and team performance	1	e.g. psychological, medical, physiological, social, organisational, communication, stress, human error, working knowledge and skills
ATSEP.QLF.SHR.HUF_2	WORKING KNOWLEDGE AND SKILLS		
ATSEP.QLF.SHR.HUF_2.1	ATSEP Knowledge, Skills and Competence		
ATSEP.QLF.SHR.HUF_2.1.1	Explain the importance of maintaining and updating professional knowledge and skills	2	Assure safety
ATSEP.QLF.SHR.HUF_2.1.2	Explain the importance of maintaining non-technical skills and professional competence	2	e.g. communication, human relationship, knowledge of environment, human limit awareness
ATSEP.QLF.SHR.HUF_2.1.3	State the available means to maintain professional knowledge and skills	1	e.g. practice, personal study, briefing, seminars, courses, technical periodicals, technical books, OJT, simulation, CBT, e-learning, visits, feedback, TRM
ATSEP UID <i>(Unique Identifier)</i>	Objective CORPUS	T A X	CONTENT
ATSEP.QLF.SHR.HUF_3	PSYCHOLOGICAL FACTORS		
ATSEP.QLF.SHR.HUF_3.1	Cognition		

ATSEP UID <i>(Unique Identifier)</i>	<i>Objective</i> CORPUS	T A X	CONTENT
ATSEP.QLF.SHR.HUF_3.1.1	Describe major aspects of human information processing	2	Attention, memory, situation awareness (perception, comprehension, projection), decision making, action, feedback, environment
ATSEP.QLF.SHR.HUF_3.1.2	Describe the factors which influence information processing	2	e.g. stress and strain, experience, knowledge, distraction, interpersonal relations, working environment, risk perception, attitude, workload, fatigue, confidence, job security
ATSEP.QLF.SHR.HUF_3.1.3	Characterise factors which influence information processing	3	e.g. case study, simulation, role playing
ATSEP.QLF.SHR.HUF_4	MEDICAL FACTORS		
ATSEP.QLF.SHR.HUF_4.1	Fatigue		
ATSEP.QLF.SHR.HUF_4.1.1	Describe the effect of fatigue on human performance	2	Physiological, cognitive and relational effects e.g. lack of concentration, irritability, frustration
ATSEP.QLF.SHR.HUF_4.1.2	Recognise the signs of fatigue in oneself and in others	1	e.g. making frequent mistakes, unable to concentrate, lack of normal humour, sleeping and/or eating disorders
ATSEP.QLF.SHR.HUF_4.1.3	Explain how to respond to indications of fatigue in an appropriate manner	2	Take time off, rest for short periods of time, seek professional help
ATSEP.QLF.SHR.HUF_4.2	Fitness		
ATSEP.QLF.SHR.HUF_4.2.1	Describe signs of lack of personal fitness	2	-

ATSEP UID <i>(Unique Identifier)</i>	Objective CORPUS	T A X	CONTENT
ATSEP.QLF.SHR.HUF_4.2.2	Describe actions to prevent or resolve lack of personal fitness	2	Healthy lifestyle e.g. healthy diet, sleeping, physical and mental activities
ATSEP.QLF.SHR.HUF_4.2.3	Explain the influence of psychoactive substances on human performance	2	e.g. nervous system, medication, smoking, alcohol, habitual and occasional use of psychoactive substances
ATSEP.QLF.SHR.HUF_4.3 Work Environment			
ATSEP.QLF.SHR.HUF_4.3.1	Describe the influence of the work environment on human performance	2	Ergonomics, effects of noise, electromagnetic waves, temperature, working circumstances
ATSEP.QLF.SHR.HUF_5 ORGANISATIONAL AND SOCIAL FACTORS			
ATSEP.QLF.SHR.HUF_5.1 Basic Needs of People at Work			
ATSEP.QLF.SHR.HUF_5.1.1	Explain basic needs of people at work	2	e.g. balance between individual ability and workload, working time and rest periods; adequate working conditions, positive working environment
ATSEP UID <i>(Unique Identifier)</i>	Objective CORPUS	T A X	CONTENT
ATSEP.QLF.SHR.HUF_5.1.2	Characterise the factors of work satisfaction	2	e.g. money, motivation, achievement, recognition, advancement, challenge
ATSEP.QLF.SHR.HUF_5.2 Team Resource Management (TRM)			
ATSEP.QLF.SHR.HUF_5.2.1	State the objectives of TRM	1	Experience sharing, feedback, improved interpersonal relations, indirect increase in safety

ATSEP UID <i>(Unique Identifier)</i>	<i>Objective</i> CORPUS	T A X	CONTENT
ATSEP.QLF.SHR.HUF_5.3	Teamwork and Team Roles		
ATSEP.QLF.SHR.HUF_5.3.1	Describe the differences between social human relations and professional interactions	2	-
ATSEP.QLF.SHR.HUF_5.3.2	Take account of reasons for loss of team effectiveness and actions to prevent it and prevent repetition	2	e.g. roles poorly defined, goals poorly identified, bad planning, too many leaders or not enough, respect for others, divergence in values, misunderstandings
ATSEP.QLF.SHR.HUF_5.3.3	Describe the principles of teamwork	2	e.g. team membership, group dynamics, advantages/disadvantages of teamwork
ATSEP.QLF.SHR.HUF_5.3.4	Appreciate reasons for conflict	3	-
ATSEP.QLF.SHR.HUF_5.3.5	Describe actions to prevent human conflicts	2	-
ATSEP.QLF.SHR.HUF_5.3.6	Describe strategies to cope with human conflicts	2	-
ATSEP.QLF.SHR.HUF_6	COMMUNICATION		
ATSEP.QLF.SHR.HUF_6.1	Written Report		
ATSEP.QLF.SHR.HUF_6.1.1	Describe the importance of recording information by writing effectively	2	ATSEP technical report, logs, system degradation reports, specification, system manager report
ATSEP.QLF.SHR.HUF_6.1.2	Use appropriate terminology to communicate effectively in writing	3	Be concise, clear; common technical terms; convey key points
ATSEP.QLF.SHR.HUF_6.2	Verbal and Non-Verbal Communication		
ATSEP.QLF.SHR.HUF_6.2.1	Describe the human communication process	2	-

ATSEP UID <i>(Unique Identifier)</i>	Objective CORPUS	T A X	CONTENT
ATSEP.QLF.SHR.HUF_6.2.2	Characterise the factors which affect verbal communication	2	e.g. Cognitive: lack of knowledge of the procedures, of technical terms, workload, poor receiver references Affective: being shy, feelings of not being listened to, not being part of the group, not being assertive, poor eye contact while talking, stress Physiological: stuttering, low voice level
ATSEP.QLF.SHR.HUF_6.2.3	Describe factors which affect non- verbal communication	2	e.g. touch, noise, interruption, body language
ATSEP UID <i>(Unique Identifier)</i>	Objective CORPUS	T A X	CONTENT
ATSEP.QLF.SHR.HUF_6.2.4	Use appropriate vocabulary to communicate effectively on technical matters	3	Technical ‘jargon’, language differences, standard words/phrases
ATSEP.QLF.SHR.HUF_6.2.5	Use appropriate language for professional communication with non-ATSEP	3	Term sharing, translation, being concise, simple words, selection of information and detail level according to the receiver
ATSEP.QLF.SHR.HUF_7	STRESS		
ATSEP.QLF.SHR.HUF_7.1	Stress		
ATSEP.QLF.SHR.HUF_7.1.1	Explain the process of stress	2	Causes, stress mechanism, consequences in different work situations (e.g. online intervention, maintenance, training)
ATSEP.QLF.SHR.HUF_7.1.2	State the symptoms of stress	1	e.g. frustration, anger, irritability, aggressive and/or irrational behaviour, helplessness

ATSEP UID <i>(Unique Identifier)</i>	<i>Objective</i> CORPUS	T A X	CONTENT
ATSEP.QLF.SHR.HUF_7.2	Stress Management		
ATSEP.QLF.SHR.HUF_7.2.1	Explain to relieve or minimise stress in self and/or others	2	The effect of personality in coping with stress, benefits of active stress management
ATSEP.QLF.SHR.HUF_7.2.2	Appreciate how assistance is obtained in stressful situations	3	Benefits of asking, offering and accepting help in stressful situations e.g. CISM
ATSEP.QLF.SHR.HUF_7.2.3	Recognise the effects of shocking and stressful situations	1	For oneself and for others, abnormal situations
ATSEP.QLF.SHR.HUF_7.2.4	Consider the benefits of critical incident stress management	2	-
ATSEP.QLF.SHR.HUF_8	HUMAN ERROR		
ATSEP.QLF.SHR.HUF_8.1	Human Error		
ATSEP.QLF.SHR.HUF_8.1.1	Describe human error	2	-
ATSEP.QLF.SHR.HUF_8.1.2	Explain the relationship between human error and safety	2	Mechanism, error-prone conditions, consequences e.g. Reason model, feedback
ATSEP.QLF.SHR.HUF_8.1.3	State different types of errors using an appropriate model	1	e.g. Rasmussen model, Gagne model
ATSEP.QLF.SHR.HUF_8.1.4	Differentiate between errors and violations	2	-
ATSEP.QLF.SHR.HUF_8.1.5	Explain how to detect errors	2	e.g. individual and collective strategy, event report, procedure
ATSEP.QLF.SHR.HUF_8.1.6	Explain, in general terms, how errors are mitigated	2	-
ATSEP.QLF.SHR.HUF_8.1.7	Describe two significant ATM incidents/accidents involving ATSEP/engineering contributory factors	2	-
ATSEP.QLF.SHR.FST	FUNCTIONAL SAFETY		

ATSEP UID <i>(Unique Identifier)</i>	<i>Objective</i>	CORPUS	T A X	CONTENT
ATSEP.QLF.SHR.FST_1		SAFETY ATTITUDE		
ATSEP.QLF.SHR.FST_1.1		Safety Attitude		
ATSEP UID <i>(Unique Identifier)</i>	<i>Objective</i>	CORPUS	T A X	CONTENT
ATSEP.QLF.SHR.FST_1.1.1		State the role of ATSEP in safety management routines and in reporting processes	1	Safety assessment documentation related to navigation, communication and surveillance system, safety reports and occurrences, safety monitoring
ATSEP.QLF.SHR.FST_2		FUNCTIONAL SAFETY		
ATSEP.QLF.SHR.FST_2.1		Functional Safety		
ATSEP.QLF.SHR.FST_2.1.1		Describe the implications of functional failures in terms of exposure time, environment, effect on controller and effect on pilot	2	Total or partial, premature or delayed operation, spurious, intermittent, loss or corruption of data, missing or incorrect input or output Ref.: safety policy and implementation
ATSEP.QLF.SHR.FST_2.1.2		Explain the need for NOTAMs	2	e.g. for PBN and GNSS status
ATSEP.QLF.SHR.ISS		INFORMATION SYSTEM SECURITY		
ATSEP.QLF.SHR.ISS_1		INTRODUCTION		
ATSEP.QLF.SHR.ISS_1.1		Purpose and Principles		
ATSEP.QLF.SHR.ISS_1.1.1		Define information system security and the relevant terminology	1	e.g. information security, cyber security, network security, physical security, etc.

ATSEP UID <i>(Unique Identifier)</i>	<i>Objective</i> CORPUS	T A X	CONTENT
ATSEP.QLF.SHR.ISS_1.1.2	Define the regulatory framework	1	ICAO, EU regulations, NIS Directive
ATSEP.QLF.SHR.ISS_1.1.3	List the concepts governing a security policy	1	Security objectives, business continuity e.g. resilience, recovery plan
ATSEP.QLF.SHR.ISS_1.1.4	List the relevant security managerial personnel	1	
ATSEP.QLF.SHR.ISS_1.1.5	Appreciate the security risk management system in an ANSP's organisation	3	Risk based approach, risk assessment, threats, vulnerabilities, residual risks, impact, likelihood, risk treatment
ATSEP.QLF.SHR.ISS_1.1.6	Explain information security frameworks	2	e.g. ISO, NIST
ATSEP.QLF.SHR.ISS_1.1.7	Explain the Confidentiality, Integrity and Availability (CIA) concept	2	
ATSEP.QLF.SHR.ISS_1.1.8	Appreciate the security threats faced by the functional system	3	ATM/ANS
ATSEP.QLF.SHR.ISS_1.1.9	Explain different network and physical attacks	2	DoS, DDoS, port scanning, network sniffing, spoofing, MITM, APT(Advance Persistent Threat) e.g. tailgating, crypto-jacking
ATSEP.QLF.SHR.ISS_1.1.10	Explain social engineering techniques	2	Social networking, human flaws, phishing, spear head phishing
ATSEP.QLF.SHR.ISS_1.1.11	Explain different types of malware	2	Viruses, worms, spyware, ransomware
ATSEP.QLF.SHR.ISS_1.1.12	Identify the different phases of security attack	3	e.g. cyber kill chain, Swiss cheese model
ATSEP.QLF.SHR.ISS_1.1.13	Appreciate how to detect and stop security attacks	3	e.g. cyber kill chain

ATSEP UID <i>(Unique Identifier)</i>	<i>Objective</i> CORPUS	T A X	CONTENT
ATSEP UID <i>(Unique Identifier)</i>	<i>Objective</i> CORPUS	T A X	CONTENT
ATSEP.QLF.SHR.ISS_1.1.14	Appreciate a holistic security architecture	3	Application security, network security, operating systems security, role of SOC/CERT, system of systems e.g. firewalls, proxies, routers, switches, network data flow, PKIs, DMZ, IDS/IPS, etc.

Appendix 4 — Qualification training — Streams

Regulation (EU) 2017/343

1. COMMUNICATION — VOICE

Subject 1: VOICE

TOPIC 1 — Air-Ground

Sub-topic 1.1 — Transmission/Reception

Sub-topic 1.2 — Radio Antenna Systems

Sub-topic 1.3 — Voice Switch

Sub-topic 1.4 — Controller Working Position

Sub-topic 1.5 — Radio Interfaces

TOPIC 2 — COMVCE — Ground-Ground

Sub-topic 2.1 — Interfaces

Sub-topic 2.2 — Protocols

Sub-topic 2.3 — Switch

Sub-topic 2.4 — Communication chain

Sub-topic 2.5 — Controller working position

Subject 2: TRANSMISSION PATH

TOPIC 1 — Lines

Sub-topic 1.1 — Lines Theory

Sub-topic 1.2 — Digital Transmissions

Sub-topic 1.3 — Types of Lines

TOPIC 2 — Specific Links

Sub-topic 2.1 — Microwave Link

Sub-topic 2.2 — Satellite

Subject 3: RECORDERS

TOPIC 1 — Legal Recorders

Sub-topic 1.1 — Regulations

Sub-topic 1.2 — Principles

Subject 4: FUNCTIONAL SAFETY

TOPIC 1 — Safety Attitude

Sub-topic 1.1 — Safety Attitude

TOPIC 2 — Functional Safety

Sub-topic 2.1 — Functional safety

2. COMMUNICATION — DATA

Subject 1: DATA

TOPIC 1 — Introduction to Networks

Sub-topic 1.1 — Types

Sub-topic 1.2 — Networks

Sub-topic 1.3 — External Network Services

Sub-topic 1.4 — Measuring Tools

Sub-topic 1.5 — Troubleshooting

TOPIC 2 — Protocols

Sub-topic 2.1 — Fundamental Theory

Sub-topic 2.2 — General Protocols

Sub-topic 2.3 — Specific Protocols

TOPIC 3 — National Networks

Sub-topic 3.1 — National Networks

TOPIC 4 — European Networks

Sub-topic 4.1 — Network Technologies

TOPIC 5 — Global Networks

Sub-topic 5.1 — Networks and Standards

Sub-topic 5.2 — Description

Sub-topic 5.3 — Global Architecture

Sub-topic 5.4 — Air-Ground Sub-Networks

Sub-topic 5.5 — Ground-Ground Sub-Networks

Sub-topic 5.6 — Networks on Board of the Aircraft

Sub-topic 5.7 — Air-Ground Applications

Subject 2: TRANSMISSION PATH*TOPIC 1 — Lines*

Sub-topic 1.1 — Lines Theory

Sub-topic 1.2 — Digital Transmission

Sub-topic 1.3 — Types of Lines

TOPIC 2 — Specific Links

Sub-topic 2.1 — Microwave Link

Sub-topic 2.2 — Satellite

Subject 3: RECORDERS*TOPIC 1 — Legal Recorders*

Sub-topic 1.1 — Regulations

Sub-topic 1.2 — Principles

Subject 4: FUNCTIONAL SAFETY

TOPIC 1 — Safety Altitude

Sub-topic 1.1 — Safety Attitude

TOPIC 2 — Functional Safety

Sub-topic 2.1 — Functional Safety

3. NAVIGATION — NON-DIRECTIONAL BEACON (NDB)

Subject 1: PERFORMANCE-BASED NAVIGATION

TOPIC 1 — Navigation Concepts

Sub-topic 1.1 — Operational Requirements

Sub-topic 1.2 — Performance-based Navigation

Sub-topic 1.3 — Area Navigation Concept (RNAV)

Sub-topic 1.4 — NOTAM

Subject 2: GROUND-BASED SYSTEMS — NDB

TOPIC 1 — NDB/Locator

Sub-topic 1.1 — Use of the System

Sub-topic 1.2 — Ground Station Architecture

Sub-topic 1.3 — Transmitter Sub-system

Sub-topic 1.4 — Antenna Sub-system

Sub-topic 1.5 — Monitoring and Control Sub-systems

Sub-topic 1.6 — On-board Equipment

Sub-topic 1.7 — System Check and Maintenance

Subject 3: GLOBAL NAVIGATION SATELLITE SYSTEM

TOPIC 1 — GNSS

Sub-topic 1.1 — General View

Subject 4: ON-BOARD EQUIPMENT

TOPIC 1 — On-board Systems

Sub-topic 1.1 — On-board Systems

TOPIC 2 — Autonomous Navigation

Sub-topic 2.1 — Inertial Navigation

TOPIC 3 — Vertical Navigation

Sub-topic 3.1 — Vertical Navigation

Subject 5: FUNCTIONAL SAFETY

TOPIC 1 — Safety Attitude

Sub-topic 1.1 — Safety Attitude

TOPIC 2 — Functional Safety

Sub-topic 2.1 — Functional Safety

4. NAVIGATION — DIRECTION FINDING (DF)**Subject 1: PERFORMANCE-BASED NAVIGATION***TOPIC 1 — Navigation Concepts*

Sub-topic 1.1 — Operational Requirements

Sub-topic 1.2 — Performance-Based Navigation

Sub-topic 1.3 — Area Navigation Concept (RNAV)

Sub-topic 1.4 — NOTAM

Subject 2: GROUND-BASED SYSTEMS — DF*TOPIC 1 — DF*

Sub-topic 1.1 — Use of the System

Sub-topic 1.2 — VDF/DDF Equipment Architecture

Sub-topic 1.3 — Receiver Sub-system

Sub-topic 1.4 — Antenna Sub-system

Sub-topic 1.5 — Monitoring and Control Sub-systems

Sub-topic 1.6 — System Check and Maintenance

Subject 3: GLOBAL NAVIGATION SATELLITE SYSTEM*TOPIC 1 — GNSS*

Sub-topic 1.1 — General View

Subject 4: ON-BOARD EQUIPMENT*TOPIC 1 — On-board Systems*

Sub-topic 1.1 — On-board Systems

TOPIC 2 — Autonomous Navigation

Sub-topic 2.1 — Inertial Navigation

TOPIC 3 — Vertical Navigation

Sub-topic 3.1 — Vertical Navigation

Subject 5: FUNCTIONAL SAFETY*TOPIC 1 — Safety Attitude*

Sub-topic 1.1 — Safety Attitude

TOPIC 2 — Functional Safety

Sub-topic 2.1 — Functional Safety

5. NAVIGATION — VHF OMNIDIRECTIONAL RADIO RANGE (VOR)**Subject 1: PERFORMANCE-BASED NAVIGATION***TOPIC 1 — Navigation Concepts*

Sub-topic 1.1 — Operational Requirements

Sub-topic 1.2 — Performance-Based Navigation

Sub-topic 1.3 — Area Navigation Concept (RNAV)

Sub-topic 1.4 — NOTAM

Subject 2: GROUND-BASED SYSTEMS — VOR

TOPIC 1 — VOR

Sub-topic 1.1 — Use of the System

Sub-topic 1.2 — Fundamentals of CVOR and/or DVOR

Sub-topic 1.3 — Ground Station Architecture

Sub-topic 1.4 — Transmitter Sub-system

Sub-topic 1.5 — Antenna Sub-system

Sub-topic 1.6 — Monitoring and Control Sub-system

Sub-topic 1.7 — On-board Equipment

Sub-topic 1.8 — System Check and Maintenance

Subject 3: GLOBAL NAVIGATION SATELLITE SYSTEM

TOPIC 1 — GNSS

Sub-topic 1.1 — General View

Subject 4: ON-BOARD EQUIPMENT

TOPIC 1 — On-board Systems

Sub-topic 1.1 — On-board Systems

TOPIC 2 — Autonomous Navigation

Sub-topic 2.1 — Inertial Navigation

TOPIC 3 — Vertical Navigation

Sub-topic 3.1 — Vertical Navigation

Subject 5: — FUNCTIONAL SAFETY

TOPIC 1 — Safety Attitude

Sub-topic 1.1 — Safety Attitude

TOPIC 2 — Functional Safety

Sub-topic 2.1 — Functional Safety

6. NAVIGATION — DISTANCE MEASURING EQUIPMENT (DME)

Subject 1: PERFORMANCE-BASED NAVIGATION

TOPIC 1 — Navigation concepts

Sub-topic 1.1 — Operational Requirements

Sub-topic 1.2 — Performance-Based Navigation

Sub-topic 1.3 — Area Navigation Concept (RNAV)

Sub-topic 1.4 — NOTAM

Subject 2: GROUND-BASED SYSTEMS — DME

TOPIC 1 — DME

Sub-topic 1.1 — Use of the System

Sub-topic 1.2 — Fundamentals of DME

Sub-topic 1.3 — Ground Station Architecture

Sub-topic 1.4 — Receiver Sub-system

Sub-topic 1.5 — Signal Processing

Sub-topic 1.6 — Transmitter Sub-system

Sub-topic 1.7 — Antenna Sub-system

Sub-topic 1.8 — Monitoring and Control Sub-system

Sub-topic 1.9 — On-board Equipment

Sub-topic 1.10 — System Check and Maintenance

Subject 3: GLOBAL NAVIGATION SATELLITE SYSTEM*TOPIC 1 — GNSS*

Sub-topic 1.1 — General View

Subject 4: ON-BOARD EQUIPMENT*TOPIC 1 — On-board Systems*

Sub-topic 1.1 — On-board Systems

TOPIC 2 — Autonomous Navigation

Sub-topic 2.1 — Inertial Navigation

TOPIC 3 — Vertical Navigation

Sub-topic 3.1 — Vertical Navigation

Subject 5: FUNCTIONAL SAFETY*TOPIC 1 — Safety Attitude*

Sub-topic 1.1 — Safety Attitude

TOPIC 2 — Functional Safety

Sub-topic 2.1 — Functional Safety

7. NAVIGATION — INSTRUMENT LANDING SYSTEM (ILS)**Subject 1: PERFORMANCE-BASED NAVIGATION***TOPIC 1 — Navigation concepts*

Sub-topic 1.1 — Operational Requirements

Sub-topic 1.2 — Performance-Based Navigation

Sub-topic 1.3 — Area Navigation Concept (RNAV)

Sub-topic 1.4 — NOTAM

Subject 2: GROUND-BASED SYSTEMS — ILS*TOPIC 1 — ILS*

Sub-topic 1.1 — Use of the System

Sub-topic 1.2 — Fundamentals of ILS

Sub-topic 1.3 — 2F-Systems

Sub-topic 1.4 — Ground Station Architecture

Sub-topic 1.5 — Transmitter Sub-system

Sub-topic 1.6 — Antenna Sub-system

Sub-topic 1.7 — Monitoring and Control Sub-system

Sub-topic 1.8 — On-board Equipment

Sub-topic 1.9 — System Check and Maintenance

Subject 3: GLOBAL NAVIGATION SATELLITE SYSTEM

TOPIC 1 — GNSS

Sub-topic 1.1 — General View

Subject 4: ON-BOARD EQUIPMENT

TOPIC 1 — On-board Systems

Sub-topic 1.1 — On-board Systems

TOPIC 2 — Autonomous navigation

Sub-topic 2.1 — Inertial Navigation

TOPIC 3 — Vertical Navigation

Sub-topic 3.1 — Vertical Navigation

Subject 5: FUNCTIONAL SAFETY

TOPIC 1 — Safety Attitude

Sub-topic 1.1 — Safety Attitude

TOPIC 2 — Functional Safety

Sub-topic 2.1 — Functional Safety

8. NAVIGATION — MICROWAVE LANDING SYSTEM (MLS)

Subject 1: PERFORMANCE-BASED NAVIGATION

TOPIC 1 — Navigation Concepts

Sub-topic 1.1 — Operational Requirements

Sub-topic 1.2 — Performance-Based Navigation

Sub-topic 1.3 — Area Navigation Concept (RNAV)

Sub-topic 1.4 — NOTAM

Subject 2: GROUND-BASED SYSTEMS — MLS

TOPIC 1 — MLS

Sub-topic 1.1 — Use of the System

Sub-topic 1.2 — Fundamentals of MLS

Sub-topic 1.3 — Ground Station Architecture

Sub-topic 1.4 — Transmitter Sub-system

Sub-topic 1.5 — Antenna Sub-system

Sub-topic 1.6 — Monitoring and Control Sub-system

Sub-topic 1.7 — On-board Equipment

Sub-topic 1.8 — System Check and Maintenance

Subject 3: GLOBAL NAVIGATION SATELLITE SYSTEM

TOPIC 1 — GNSS

Sub-topic 1.1 — General View

Subject 4: ON-BOARD EQUIPMENT

TOPIC 1 — On-board Systems

Sub-topic 1.1 — On-board Systems

TOPIC 2 — Autonomous navigation

Sub-topic 2.1 — Inertial Navigation

TOPIC 3 — Vertical navigation

Sub-topic 3.1 — Vertical Navigation

Subject 5: FUNCTIONAL SAFETY

TOPIC 1 — Safety attitude

Sub-topic 1.1 — Safety Attitude

TOPIC 2 — Functional safety

Sub-topic 2.1 — Functional Safety

9. SURVEILLANCE — PRIMARY SURVEILLANCE RADAR

Subject 1: PRIMARY SURVEILLANCE RADAR

TOPIC 1 — ATC surveillance

Sub-topic 1.1 — Use of PSR for Air Traffic Services

Sub-topic 1.2 — Antenna (PSR)

Sub-topic 1.3 — Transmitters

Sub-topic 1.4 — Characteristics of Primary Targets

Sub-topic 1.5 — Receivers

Sub-topic 1.6 — Signal Processing and Plot Extraction

Sub-topic 1.7 — Plot Combining

Sub-topic 1.8 — Characteristics of Primary Radar

TOPIC 2 — SURPSR — Surface Movement Radar

Sub-topic 2.1 — Use of SMR for Air Traffic Services

Sub-topic 2.2 — Radar Sensor

TOPIC 3 — SURPSR — Test and Measurement

Sub-topic 3.1 — Test and Measurement

Subject 2: HUMAN MACHINE INTERFACE (HMI)*TOPIC 1 — SURPSR — HMI*

Sub-topic 1.1 — ATCO HMI

Sub-topic 1.2 — ATSEP HMI

Sub-topic 1.3 — Pilot HMI

Sub-topic 1.4 — Displays

Subject 3: SURVEILLANCE DATA TRANSMISSION*TOPIC 1 — SDT*

Sub-topic 1.1 — Technology and Protocols

Sub-topic 1.2 — Verification Methods

Subject 4: FUNCTIONAL SAFETY*TOPIC 1 — SURPSR — Safety Attitude*

Sub-topic 1.1 — Safety Attitude

TOPIC 2 — SURPSR — Functional Safety

Sub-topic 2.1 — Functional Safety

Subject 5: DATA PROCESSING SYSTEMS*TOPIC 1 — System Components*

Sub-topic 1.1 — Surveillance Data Processing Systems

10. SURVEILLANCE — SECONDARY SURVEILLANCE RADAR**Subject 1: SECONDARY SURVEILLANCE RADAR (SSR)***TOPIC 1 — SSR and Mono-pulse SSR*

Sub-topic 1.1 — Use of SSR for Air Traffic Services

Sub-topic 1.2 — Antenna (SSR)

Sub-topic 1.3 — Interrogator

Sub-topic 1.4 — Transponder

Sub-topic 1.5 — Receivers

Sub-topic 1.6 — Signal Processing and Plot Extraction

Sub-topic 1.7 — Plot Combining

Sub-topic 1.8 — Test and Measurement

TOPIC 2 — Mode S

Sub-topic 2.1 — Introduction to Mode S

Sub-topic 2.2 — Mode S System

TOPIC 3 — Multilateration

Sub-topic 3.1 — MLAT in use

Sub-topic 3.2 — MLAT Principles

TOPIC 4 — SURSSR — Environment

Sub-topic 4.1 — SSR Environment

Subject 2: HUMAN MACHINE INTERFACE (HMI)

TOPIC 1 — HMI

Sub-topic 1.1 — ATCO HMI

Sub-topic 1.2 — ATSEP HMI

Sub-topic 1.3 — Pilot HMI

Sub-topic 1.4 — Displays

Subject 3: SURVEILLANCE DATA TRANSMISSION

TOPIC 1 — SDT

Sub-topic 1.1 — Technology and Protocols

Sub-topic 1.2 — Verification Methods

Subject 4: FUNCTIONAL SAFETY

TOPIC 1 — Safety attitude

Sub-topic 1.1 — Safety Attitude

TOPIC 2 — Functional safety

Sub-topic 2.1 — Functional Safety

Subject 5: DATA PROCESSING SYSTEMS

TOPIC 1 — System components

Sub-topic 1.1 — Surveillance Data Processing Systems

11. SURVEILLANCE — AUTOMATIC DEPENDENT SURVEILLANCE

Subject 1: AUTOMATIC DEPENDENT SURVEILLANCE (ADS)

TOPIC 1 — General view on ADS

Sub-topic 1.1 — Definition of ADS

TOPIC 2 — SURADS — ADS-B

Sub-topic 2.1 — Introduction to ADS-B

Sub-topic 2.2 — Techniques of ADS-B

Sub-topic 2.3 — VDL Mode 4 (STDMA)

Sub-topic 2.4 — Mode S Extended Squitter

Sub-topic 2.5 — UAT

Sub-topic 2.6 — ASTERIX

TOPIC 3 — ADS-C

Sub-topic 3.1 — Introduction to ADS-C

Sub-topic 3.2 — Techniques in ADS-C

Subject 2: HUMAN MACHINE INTERFACE (HMI)

TOPIC 1 — HMI

Sub-topic 1.1 — ATCO HMI

Sub-topic 1.2 — ATSEP HMI

Sub-topic 1.3 — Pilot HMI

Sub-topic 1.4 — Displays

Subject 3: SURVEILLANCE DATA TRANSMISSION

TOPIC 1 — SDT

Sub-topic 1.1 — Technology and Protocols

Sub-topic 1.2 — Verification Methods

Subject 4: FUNCTIONAL SAFETY

TOPIC 1 — Safety Attitude

Sub-topic 1.1 — Safety Attitude

TOPIC 2 — SURADS — Functional Safety

Sub-topic 2.1 — Functional Safety

Subject 5: DATA PROCESSING SYSTEMS

TOPIC 1 — System components

Sub-topic 1.1 — Surveillance Data Processing Systems

12. DATA — DATA PROCESSING

Subject 1: FUNCTIONAL SAFETY

TOPIC 1 — Functional Safety

Sub-topic 1.1 — Functional Safety

Sub-topic 1.2 — Software Integrity and Security

TOPIC 2 — Safety Attitude

Sub-topic 2.1 — Safety Attitude

Subject 2: DATA PROCESSING SYSTEMS

TOPIC 1 — User requirements

Sub-topic 1.1 — Controller requirements

Sub-topic 1.2 — Trajectories, Prediction and Calculation

Sub-topic 1.3 — Ground-based Safety Nets

Sub-topic 1.4 — Decision Support

TOPIC 2 — System Components Data

Sub-topic 2.1 — Data processing Systems

Sub-topic 2.2 — Flight Data Processing Systems

Sub-topic 2.3 — Surveillance Data Processing Systems

Subject 3: DATA PROCESS

TOPIC 1 — Software process

Sub-topic 1.1 — Middleware

Sub-topic 1.2 — Operating Systems

Sub-topic 1.3 — Configuration Control

Sub-topic 1.4 — Software Development Process

TOPIC 2 — Hardware platform

Sub-topic 2.1 — Equipment Upgrade

Sub-topic 2.2 — COTS

Sub-topic 2.3 — Interdependence

Sub-topic 2.4 — Maintainability

TOPIC 3 — Testing

Sub-topic 3.1 — Testing

Subject 4: DATA

TOPIC 1 — Data Essential Features

Sub-topic 1.1 — Data Significance

Sub-topic 1.2 — Data Configuration Control

Sub-topic 1.3 — Data Standards

TOPIC 2 — ATM Data — Detailed structure

Sub-topic 2.1 — System Area

Sub-topic 2.2 — Characteristic Points

Sub-topic 2.3 — Aircraft Performances

Sub-topic 2.4 — Screen Manager

Sub-topic 2.5 — Auto-coordination Messages

Sub-topic 2.6 — Configuration Control Data

Sub-topic 2.7 — Physical Configuration Data

Sub-topic 2.8 — Relevant Meteo Data

Sub-topic 2.9 — Alert and Error Messages to ATSEP

Sub-topic 2.10 — Alert and Error Messages to ATCO

Subject 5: COMMUNICATION DATA

TOPIC 1 — Introduction to Networks

Sub-topic 1.1 — Types

Sub-topic 1.2 — Networks

Sub-topic 1.3 — External Network Services

Sub-topic 1.4 — Measuring Tools

Sub-topic 1.5 — Troubleshooting

TOPIC 2 — Protocols

Sub-topic 2.1 — Fundamental Theory

Sub-topic 2.2 — General Protocols

Sub-topic 2.3 — Specific Protocols

TOPIC 3 — DATDP — National Networks

Sub-topic 3.1 — National Networks

Subject 6: SURVEILLANCE — PRIMARY

TOPIC 1 — ATC Surveillance

Sub-topic 1.1 — Use of PSR for Air Traffic Services

Subject 7: SURVEILLANCE — SECONDARY

TOPIC 1 — SSR AND MSSR

Sub-topic 1.1 — Use of SSR for Air Traffic Services

TOPIC 2 — Mode S

Sub-topic 2.1 — Introduction to Mode S

TOPIC 3 — Multilateration

Sub-topic 3.1 — MLAT Principles

Subject 8: SURVEILLANCE — HMI

TOPIC 1 — HMI

Sub-topic 1.1 — ATCO HMI

Subject 9: SURVEILLANCE DATA TRANSMISSION

TOPIC 1 — Surveillance Data Transmission

Sub-topic 1.1 — Technology and Protocols

13. SYSTEM MONITORING AND CONTROL — COMMUNICATION

Subject 1: ANS STRUCTURE

TOPIC 1 — ANSP Organisation and Operation

Sub-topic 1.1 — SMCCOM — ANSP Organisation and Operation

TOPIC 2 — ANSP Maintenance Program

Sub-topic 2.1 — Policy

TOPIC 3 — ATM Context

Sub-topic 3.1 — ATM Context

TOPIC 4 — ANSP Administrative Practices

Sub-topic 4.1 — Administration

Subject 2: ANS SYSTEM/EQUIPMENT

TOPIC 1 — Operational Impacts

Sub-topic 1.1— Degradation or Loss of System/Equipment Services

TOPIC 2 — SMCCOM — User Working Position Functionality and Operation

Sub-topic 2.1 — User Working Position

Sub-topic 2.2 — SMC Working Position

Subject 3: TOOLS, PROCESSES AND PROCEDURES*TOPIC 1 — Requirements*

Sub-topic 1.1 — SMS

Sub-topic 1.2 — QMS

Sub-topic 1.3 — SMS application in the working environment

TOPIC 2 — Maintenance Agreements with Outside Agencies

Sub-topic 2.1 — Principles of agreements

TOPIC 3 — SMC General Processes

Sub-topic 3.1 — Roles and responsibilities

TOPIC 4 — Maintenance Management Systems

Sub-topic 4.1 — Reporting

Subject 4: TECHNOLOGY*TOPIC 1 — Technologies and Principles*

Sub-topic 1.1 — General

Sub-topic 1.2 — Communication

Sub-topic 1.3 — Facilities

Subject 5: COMMUNICATION VOICE*TOPIC 1 — Air-Ground*

Sub-topic 1.1 — Controller Working Position

TOPIC 2 — Ground-Ground

Sub-topic 2.1 — Interfaces

Sub-topic 2.2 — Switch

Sub-topic 2.3 — Controller Working Position

Subject 6: COMMUNICATION — DATA*TOPIC 1 — European Networks*

Sub-topic 1.1 — Network Technologies

TOPIC 2 — Global Networks

Sub-topic 2.1 — Networks and Standards

Sub-topic 2.2 — Description

Sub-topic 2.3 — Global Architecture

Sub-topic 2.4 — Air-Ground Sub-networks

Sub-topic 2.5 — Ground-Ground Sub-networks

Sub-topic 2.6 — Air-Ground Applications

Subject 7: COMMUNICATION — RECORDERS

TOPIC 1 — Legal recorders

Sub-topic 1.1 — Regulations

Sub-topic 1.2 — Principles

Subject 8: NAVIGATION — PBN

TOPIC 1 — NAV Concepts

Sub-topic 1.1 — NOTAM

14. SYSTEM MONITORING AND CONTROL — NAVIGATION

Subject 1: ANS STRUCTURE

TOPIC 1 — ANSP Organisation and Operation

Sub-topic 1.1 — ANSP Organisation and Operation

TOPIC 2 — ANSP Maintenance Program

Sub-topic 2.1 — Policy

TOPIC 3 — ATM Context

Sub-topic 3.1 — ATM Context

TOPIC 4 — ANSP Administrative Practices

Sub-topic 4.1 — Administration

Subject 2: ANS SYSTEM/EQUIPMENT

TOPIC 1 — Operational Impacts

Sub-topic 1.1 — SMCNAV — Degradation or Loss of System/Equipment Services

TOPIC 2 — User Position Functionality and Operation

Sub-topic 2.1 — User Working Position

Sub-topic 2.2 — SMC Working Position

Subject 3: TOOLS, PROCESSES AND PROCEDURES

TOPIC 1 — SMCNAV — Requirements

Sub-topic 1.1 — SMS

Sub-topic 1.2 — QMS

Sub-topic 1.3 — SMS application in the working environment

TOPIC 2 — Maintenance Agreements with Outside Agencies

Sub-topic 2.1 — Principles of agreements

TOPIC 3 — SMC General Processes

Sub-topic 3.1 — Roles and responsibilities

TOPIC 4 — SMCNAV — Maintenance Management Systems

Sub-topic 4.1 — Reporting

Subject 4: TECHNOLOGY

TOPIC 1 — SMCNAV — Technologies and Principles

Sub-topic 1.1 — General

Sub-topic 1.2 — Communication

Sub-topic 1.3 — Facilities

Subject 5: COMMUNICATION — DATA

TOPIC 1 — SMCNAV — European Networks

Sub-topic 1.1 — Network Technologies

TOPIC 2 — Global Networks

Sub-topic 2.1 — Networks and Standards

Sub-topic 2.2 — Description

Sub-topic 2.3 — Global Architecture

Sub-topic 2.4 — Air-Ground Sub-networks

Sub-topic 2.5 — Ground-Ground Sub-networks

Sub-topic 2.6 — Air-Ground Applications

Subject 6: COMMUNICATION — RECORDERS

TOPIC 1 — Legal Recorders

Sub-topic 1.1 — Regulations

Sub-topic 1.2 — Principles

Subject 7: NAVIGATION — PBN

TOPIC 1 — NAV Concepts

Sub-topic 1.1 — NOTAM

Subject 8: NAVIGATION — GROUND-BASED SYSTEMS — NDB

TOPIC 1 — NDB/Locator

Sub-topic 1.1 — Use of the System

Subject 9: NAVIGATION — GROUND-BASED SYSTEMS — DFI

TOPIC 1 — SMCNAV — DF

Sub-topic 1.1 — Use of the System

Subject 10: NAVIGATION — GROUND-BASED SYSTEMS — VOR

TOPIC 1 — VOR

Sub-topic 1.1 — Use of the System

Subject 11: NAVIGATION — GROUND-BASED SYSTEMS — DME

TOPIC 1 — DME

Sub-topic 1.1 — Use of the System

Subject 12: NAVIGATION — GROUND-BASED SYSTEMS — ILS

TOPIC 1 — ILS

Sub-topic 1.1 — Use of the System

15. SYSTEM MONITORING AND CONTROL — SURVEILLANCE

Subject 1: ANS STRUCTURE

TOPIC 1 — ANSP Organisation and Operation

Sub-topic 1.1 — ANSP Organisation and Operation

TOPIC 2 — ANSP Maintenance Program

Sub-topic 2.1 — Policy

TOPIC 3 — ATM Context

Sub-topic 3.1 — ATM Context

TOPIC 4 — ANSP Administrative Practices

Sub-topic 4.1 — Administration

Subject 2: ANS SYSTEM/EQUIPMENT

TOPIC 1 — Operational Impacts

Sub-topic 1.1 — SMCSUR — Degradation or Loss of System/Equipment Services

TOPIC 2 — User Position Functionality and Operation

Sub-topic 2.1 — User Working Position

Sub-topic 2.2 — SMC Working Position

Subject 3: TOOLS, PROCESSES AND PROCEDURES

TOPIC 1 — Requirements

Sub-topic 1.1 — SMS

Sub-topic 1.2 — QMS

Sub-topic 1.3 — SMS application in the working environment

TOPIC 2 — Maintenance Agreements with Outside Agencies

Sub-topic 2.1 — Principles of agreements

TOPIC 3 — SMC General Processes

Sub-topic 3.1 — Roles and responsibilities

TOPIC 4 — Maintenance Management Systems

Sub-topic 4.1 — Reporting

Subject 4: TECHNOLOGY

TOPIC 1 — Technologies and Principles

Sub-topic 1.1 — General

Sub-topic 1.2 — Communication

Sub-topic 1.3 — Facilities

Subject 5: COMMUNICATION — DATA

TOPIC 1 — European Networks

Sub-topic 1.1 — Network Technologies

TOPIC 2 — Global Networks

Sub-topic 2.1 — Networks and Standards

Sub-topic 2.2 — Description

Sub-topic 2.3 — Global Architecture

Sub-topic 2.4 — Air-Ground Sub-networks

Sub-topic 2.5 — Ground-Ground sub-networks

Sub-topic 2.6 — Air-Ground Applications

Subject 6: COMMUNICATION — RECORDERS

TOPIC 1 — Legal Recorders

Sub-topic 1.1 — Regulations

Sub-topic 1.2 — Principles

Subject 7: NAVIGATION — PBN

TOPIC 1 — NAV Concepts

Sub-topic 1.1 — NOTAM

Subject 8: SURVEILLANCE — PRIMARY

TOPIC 1 — ATC Surveillance

Sub-topic 1.1 — Use of PSR for Air Traffic Services

Subject 9: SURVEILLANCE — SECONDARY

TOPIC 1 — SSR AND MSSR

Sub-topic 1.1 — Use of SSR for Air Traffic Services

TOPIC 2 — Mode S

Sub-topic 2.1 — Introduction to Mode S

TOPIC 3 — Multilateration

Sub-topic 3.1 — MLAT Principles

Subject 10: SURVEILLANCE — HMI

TOPIC 1 — HMI

Sub-topic 1.1 — ATCO HMI

Subject 11: SURVEILLANCE — DATA TRANSMISSION

TOPIC 1 — Surveillance Data Transmission

Sub-topic 1.1 — Technology and Protocols

16. SYSTEM MONITORING AND CONTROL — DATA

Subject 1: ANS STRUCTURE*TOPIC 1 — ANSP Organisation and Operation*

Sub-topic 1.1 — ANSP Organisation and Operation

TOPIC 2 — ANSP Maintenance Program

Sub-topic 2.1 — Policy

TOPIC 3 — ATM Context

Sub-topic 3.1 — ATM Context

TOPIC 4 — ANSP ADMINISTRATIVE PRACTICES

Sub-topic 4.1 — Administration

Subject 2: ANS SYSTEM/EQUIPMENT*TOPIC 1 — Operational Impacts*

Sub-topic 1.1 — Degradation or Loss of System/Equipment Services

TOPIC 2 — User Position Functionality and Operation

Sub-topic 2.1 — User Working Position

Sub-topic 2.2 — SMC Working Position

Subject 3: TOOLS, PROCESSES AND PROCEDURES*TOPIC 1 — SMCDAT — Requirements*

Sub-topic 1.1 — SMS

Sub-topic 1.2 — QMS

Sub-topic 1.3 — SMS application in the working environment

TOPIC 2 — Maintenance Agreements with Outside Agencies

Sub-topic 2.1 — Principles of agreements

TOPIC 3 — SMC General Processes

Sub-topic 3.1 — Roles and responsibilities

TOPIC 4 — Maintenance Management Systems

Sub-topic 4.1 — Reporting

Subject 4: TECHNOLOGY*TOPIC 1 — Technologies and Principles*

Sub-topic 1.1 — General

Sub-topic 1.2 — Communication

Sub-topic 1.3 — Facilities

Subject 5: COMMUNICATION — DATA*TOPIC 1 — European Networks*

Sub-topic 1.1 — Network Technologies

TOPIC 2 — Global Networks

Sub-topic 2.1 — Networks and Standards

Sub-topic 2.2 — Description

Sub-topic 2.3 — Global Architecture

Sub-topic 2.4 — Air-Ground Sub-networks

Sub-topic 2.5 — Ground-Ground sub-networks

Sub-topic 2.6 — Air-Ground Applications

Subject 6: COMMUNICATION — RECORDERS

TOPIC 1 — Legal Recorders

Sub-topic 1.1 — Regulations

Sub-topic 1.2 — Principles

Subject 7: NAVIGATION — PBN

TOPIC 1 — SMCDAT — NAV Concepts

Sub-topic 1.1 — NOTAM

Subject 8: SURVEILLANCE — PRIMARY

TOPIC 1 — ATC Surveillance

Sub-topic 1.1 — Use of PSR for Air Traffic Services

Subject 9: SURVEILLANCE — SECONDARY

TOPIC 1 — SSR AND MSSR

Sub-topic 1.1 — Use of SSR for Air Traffic Services

TOPIC 2 — Mode S

Sub-topic 2.1 — Introduction to Mode S

TOPIC 3 — Multilateration

Sub-topic 3.1 — MLAT Principles

Subject 10: SURVEILLANCE — HMI

TOPIC 1 — HMI

Sub-topic 1.1 — ATCO HMI

Subject 11: SURVEILLANCE — DATA TRANSMISSION

TOPIC 1 — Surveillance Data Transmission

Sub-topic 1.1 — Technology and Protocols

Subject 12: SURVEILLANCE — DATA PROCESSING SYSTEMS

TOPIC 1 — User Requirements

Sub-topic 1.1 — Controller requirements

Sub-topic 1.2 — Trajectories, Prediction and Calculation

Sub-topic 1.3 — Ground-based Safety Nets

Sub-topic 1.4 — Decision Support

Subject 13: SURVEILLANCE — DATA PROCESS*TOPIC 1 — Hardware Platform*

Sub-topic 1.1 — Equipment Upgrade

Sub-topic 1.2 — COTS

Sub-topic 1.3 — Interdependence

Subject 14: SURVEILLANCE — DATA*TOPIC 1 — Data Essentials Features*

Sub-topic 1.1 — Data Significance

Sub-topic 1.2 — Data Configuration Control

Sub-topic 1.2 — Data Standards

Appendix 4a — Qualification training — Streams

ED Decision 2020/020/R

Subjects, topics and sub-topics from Appendix 4a are repeated in this AMC for the convenience of the reader and do not form a part of it.

ATSEP QUALIFICATION - Streams														ATSEP UID (Unique Objective Identifier)	CORPUS	Tax	CONTENT	
COM-	COM-Data	NAV-NDR	NAV-DE	NAV-VOR	NAV-DMF	NAV-IIS	SLIP-DCP	SLIP-SSR	SLIP-ADS	DPR-DP	SMC-COM	SMC-NAV	SMC-SLR					SMC-DP
X	X	X	X	X	X	X	X	X	X		X				ATSEP.QLF.COM	ATSEP QUALIFICATION DOMAIN - COMMUNICATION		
X		X	X	X	X	X	X	X	X		X				ATSEP.QLF.COM.VCE	VOICE		
X		X	X	X	X	X	X	X	X		X				ATSEP.QLF.COM.VCE_1	AIR-GROUND		
X															ATSEP.QLF.COM.VCE_1.1	Transmission/Reception		
X															ATSEP.QLF.COM.VCE_1.1.1	Appreciate typical measurements on a transmitter	3	Frequency (single carrier, offset carrier), modulation, output power, SWR, adjacent channel power
X															ATSEP.QLF.COM.VCE_1.1.2	Appreciate a generic radio transmitter	3	Frequency power, modulation index, audio input level
X															ATSEP.QLF.COM.VCE_1.1.3	Identify the main elements in a block diagram of a generic radio transmitter	3	Characteristics (modulation, single carrier, channel spacing), functionalities
X															ATSEP.QLF.COM.VCE_1.1.4	Perform typical measurements on a receiver	3	Frequency, modulation, channel spacing, sensitivity, selectivity
X															ATSEP.QLF.COM.VCE_1.1.5	Appreciate a generic radio receiver	3	Signal to noise ratio, audio input level, frequency
X															ATSEP.QLF.COM.VCE_1.1.6	Identify the main elements of a block diagram of a generic radio receiver	3	Characteristics (single carrier, channel spacing, sensitivity, selectivity)

ATSEP QUALIFICATION - Streams														ATSEP UID (Unique Objective Identifier)	CORPUS	Tax	CONTENT	
COM-	COM-Data	NAV-NDR	NAV-DE	NAV-VOR	NAV-DMF	NAV-ILS	SLIP-DCR	SLIP-SSR	SLIP-ADS	DPR-DP	SMC-COM	SMC-NAV	SMC-SLR					SMC-DP
X															ATSEP.QLF.COM.VCE_1.1.7	Characterise intermodulation and interference phenomena	2	Collocation of multiple transmitters at the same radio site, external interference (jamming, etc.)
X		X	X	X	X	X	X	X	X						ATSEP.QLF.COM.VCE_1.2	Radio Antenna Systems		
X		X	X	X	X	X	X	X	X						ATSEP.QLF.COM.VCE_1.2.1	Explain antenna parameters	2	Impedance, polar diagram, bandwidth, gain, polarisation, types of antennas
X		X	X	X	X	X	X	X	X						ATSEP.QLF.COM.VCE_1.2.2	Characterise the coverage of the radio system	2	Polar diagram, types of antennas, frequency bands, propagation mode
X															ATSEP.QLF.COM.VCE_1.2.3	Characterise link budget according to various conditions	2	Output power, antennae, propagation, geographic, meteorological, day and night
X															ATSEP.QLF.COM.VCE_1.2.4	Characterise the elements of a generic antenna system	2	Filters, combiners, multi-cavity system
X															ATSEP.QLF.COM.VCE_1.2.5	Consider the conformity of a system to ITU and national regulation	2	Ref.: ICAO Annex 10 (VHF, UHF)
X															ATSEP.QLF.COM.VCE_1.2.6	Appreciate measurements with generic radio test equipment	3	e.g. Spectrum analyser, scanner
X															ATSEP.QLF.COM.VCE_1.3	Voice Switch		
X															ATSEP.QLF.COM.VCE_1.3.1	Explain switching functionalities	2	General architecture, digital, analogue, multiplex types, PCM e.g. cross-coupling, split headset (radio both ears, telephone single ear)
X															ATSEP.QLF.COM.VCE_1.3.2	Explain the principles of non-blocking	2	Advantages, disadvantages, delays (digital)

ATSEP QUALIFICATION - Streams													ATSEP UID (Unique Objective Identifier)	CORPUS	Tax	CONTENT		
COM-	COM-Data	NAV-NDR	NAV-DE	NAV-VOR	NAV-DMF	NAV-IIS	SLIP-DSP	SLIP-SSR	SLIP-ADS	DPR-DP	SMC-COM	SMC-NAV					SMC-SLIP	SMC-DP
																switches		
X															ATSEP.QLF.COM.VCE_1.3.3	Describe the signal processing all along the chain	2	Signal tracing treatment, protocols (a few), data flow
X											X				ATSEP.QLF.COM.VCE_1.4	Controller Working Position		
X											X				ATSEP.QLF.COM.VCE_1.4.1	Describe the most common features of a controller working position and the HMI	2	Frequency selection, emergency, station selection, coupling, headset, loudspeaker, footswitch, Push to Talk e.g. microphone (noise cancelling), short time recording
X															ATSEP.QLF.COM.VCE_1.5	Radio Interfaces		
X															ATSEP.QLF.COM.VCE_1.5.1	Describe the different types of interface	2	Internal, external, phantom signalling, in-band signal
X											X				ATSEP.QLF.COM.VCE_2	GROUND-GROUND		
X											X				ATSEP.QLF.COM.VCE_2.1	Interfaces		
ATSEP QUALIFICATION - Streams													ATSEP UID (Unique Objective Identifier)	CORPUS	Tax	CONTENT		
COM-	COM-Data	NAV-NDR	NAV-DE	NAV-VOR	NAV-DMF	NAV-IIS	SLIP-DSP	SLIP-SSR	SLIP-ADS	DPR-DP	SMC-COM	SMC-NAV					SMC-SLIP	SMC-DP
X											X				ATSEP.QLF.COM.VCE_2.1.1	Describe the different types of interfaces	2	e.g. Analogue (2, 4, 6 and 8 wires), digital (ISDN; 64 Kb, 2 Mb, IP)
X															ATSEP.QLF.COM.VCE_2.1.2	Explain the advantages and disadvantages of each type	2	e.g. Analogue (2, 4, 6 and 8 wires), digital (ISDN; 64 Kb, 2 Mb, IP)
X															ATSEP.QLF.COM.VCE_2.1.3	Operate measuring equipment	3	e.g. dB meters, level meters, generators, sniffer

ATSEP QUALIFICATION - Streams													ATSEP UID (Unique Objective Identifier)	CORPUS	Tax	CONTENT		
COM-	COM-Data	NAV-NDR	NAV-DE	NAV-VOR	NAV-DMF	NAV-ILS	SLIP-DCR	SLIP-SSR	SLIP-ADS	DPR-DP	SMC-COM	SMC-NAV					SMC-SLR	SMC-DP
X															ATSEP.QLF.COM.VCE_2.2	Protocols		
X															ATSEP.QLF.COM.VCE_2.2.1	Operate standard protocol analysers	3	e.g. MFC R2 and/or ATS QSIG (rerouting), impulse dialling and DTMF dialling, ISDN, SIP, RTP
X															ATSEP.QLF.COM.VCE_2.2.2	Analyse communication protocol with appropriate tools and documentation	4	e.g. MFC R2 , ATS QSIG (rerouting), impulse dialling and DTMF dialling, ISDN, national protocols, SIP, RTP
X											X				ATSEP.QLF.COM.VCE_2.3	Switch		
X											X				ATSEP.QLF.COM.VCE_2.3.1	State the similarities between ground- ground and air-ground switches	1	Switching techniques
X											X				ATSEP.QLF.COM.VCE_2.3.2	Describe the most commonly used functionality of PABX	2	General architecture, digital, analogue, multiplex types, PCM30 e.g. IPBX
X											X				ATSEP.QLF.COM.VCE_2.3.3	Explain conversion analogue-digital, digital-analogue	2	General architecture, analogue-digital-analogue
X															ATSEP.QLF.COM.VCE_2.4	Communication Chain		
X															ATSEP.QLF.COM.VCE_2.4.1	Appreciate the replacement of components in a communication chain in a safe way	3	Continuity of service, communication chain integrity
X											X				ATSEP.QLF.COM.VCE_2.5	Controller Working Position		
X											X				ATSEP.QLF.COM.VCE_2.5.1	Describe the most common features of a controller working position and the HMI	2	-
X										X	X	X	X	X	ATSEP.QLF.COM.DTA	DATA		

ATSEP QUALIFICATION - Streams													ATSEP UID (Unique Objective Identifier)	CORPUS	Tax	CONTENT		
COM-	COM-Data	NAV-NDR	NAV-DE	NAV-VOR	NAV-DMF	NAV-ILS	SLIP-DSP	SLIP-SSR	SLIP-ADS	DPR-DP	SMC-COM	SMC-NAV					SMC-SLIP	SMC-DP
X										X					ATSEP.QLF.COM.DTA_1	INTRODUCTION TO NETWORKS		
X										X					ATSEP.QLF.COM.DTA_1.1	Types		
X										X					ATSEP.QLF.COM.DTA_1.1.1	State the evolution of network topologies	1	LAN, WAN e.g. architectures, size of the segments, length of the systems, quality of service
X										X					ATSEP.QLF.COM.DTA_1.1.2	Explain how networks meet requirements	2	Redundancy, bandwidth, BER, time delay, network security
X										X					ATSEP.QLF.COM.DTA_1.2	Networks		
X										X					ATSEP.QLF.COM.DTA_1.2.1	Analyse the features of a network	3	Routing scheme, rate, internal networking, routers, gateways, switches, firewalls e.g. wireless networks, bridges, modems, IRB, vrf, etherchannels, vlan-trunking, nfv, spanning-tree, ipsec-tunnels, hierarchical design-mode
X										X					ATSEP.QLF.COM.DTA_1.2.2	Describe network standards and devices	2	Ethernet, optical fibre e.g. LAN/MAN: CSMA/CD, Ethernet frame types, VLAN tag (802.1q), FO cable qualities for SM and MM, connectors, SFP module types,

ATSEP QUALIFICATION - Streams														ATSEP UID (Unique Objective Identifier)	CORPUS	Tax	CONTENT	
COM-	COM-Data	NAV-NDR	NAV-DE	NAV-VOR	NAV-DMF	NAV-ILS	SLIR-DSP	SLIR-SSR	SLIR-ADS	DPR-DP	SMC-COM	SMC-NAV	SMC-SLIR					SMC-DP
																		wireless; WAN: MPLS, pdH, sdH networks
	X									X					ATSEP.QLF.COM.DTA_1.2.3	Appreciate the replacement of components in a network in a safe way	3	Continuity of service, network integrity
	X									X					ATSEP.QLF.COM.DTA_1.3	External Network Services		
	X									X					ATSEP.QLF.COM.DTA_1.3.1	Explain aspects of external network services	2	Provided QoS e.g. SLAs
	X									X					ATSEP.QLF.COM.DTA_1.4	Measuring Tools		
	X									X					ATSEP.QLF.COM.DTA_1.4.1	Identify the main parameters of the network to be measured as well as the corresponding instruments to be used	3	Types of measurements, typical parameters e.g. Data analyser (sniffer), NetScout, Wireshark
ATSEP QUALIFICATION - Streams														ATSEP UID (Unique Objective Identifier)	CORPUS	Tax	CONTENT	
COM-	COM-Data	NAV-NDR	NAV-DE	NAV-VOR	NAV-DMF	NAV-ILS	SLIR-DSP	SLIR-SSR	SLIR-ADS	DPR-DP	SMC-COM	SMC-NAV	SMC-SLIR					SMC-DP
	X									X					ATSEP.QLF.COM.DTA_1.5	Troubleshooting		
	X									X					ATSEP.QLF.COM.DTA_1.5.1	Appreciate how to troubleshoot a network	3	
	X									X					ATSEP.QLF.COM.DTA_1.5.2	Explain the principles on how to troubleshoot a network	2	-
	X									X					ATSEP.QLF.COM.DTA_2	PROTOCOLS		

ATSEP QUALIFICATION - Streams													ATSEP UID (Unique Objective Identifier)	CORPUS	Tax	CONTENT		
COM-	COM-Data	NAV-NDR	NAV-DE	NAV-VOR	NAV-DMF	NAV-ILS	SLIP-DCR	SLIP-SSR	SLIP-ADS	DPR-DP	SMC-COM	SMC-NAV					SMC-SLR	SMC-DP
	X									X					ATSEP.QLF.COM.DTA_2.1	Fundamental Theory		
	X									X					ATSEP.QLF.COM.DTA_2.1.1	Appreciate the principles of layers	3	Differences between layers e.g. layer(s) of sniffer information
	X									X					ATSEP.QLF.COM.DTA_2.1.2	Appreciate the principles of network addressing	3	Masks, prefixes, subnets IP addressing, (unicast, multicast) IPv4 and IPv6, MAC addressing e.g. same logical network computers and systems, broadcast, multicast mac addressing, dhcpv4, dhcpv6
	X									X					ATSEP.QLF.COM.DTA_2.1.3	Appreciate the principles of IP routing	3	Routing tables, preferences, fault tolerance, static and dynamic routing protocols for IPv4 and IPv6, HSRP/VRRP e.g. unicast, multicast, broadcast, OSPF, BGP, IS-IS, IDRP, multicast routing, ECMP, route summarisation
	X									X					ATSEP.QLF.COM.DTA_2.2	General Protocols		
	X									X					ATSEP.QLF.COM.DTA_2.2.1	Describe the general protocol structure	2	IPv4 and IPv6 (header, fragmentation), UDP and TCP header, TCP reliable transport
	X									X					ATSEP.QLF.COM.DTA_2.2.2	Appreciate the general application layer protocols using the appropriate tools and documentation	3	NTP, FTP e.g. SIP (Session Initiation Protocol), SMTP, HTTP
	X									X					ATSEP.QLF.COM.DTA_2.3	Specific Protocols		
	X									X					ATSEP.QLF.COM.DTA_2.3.1	Describe the specific protocols	2	FMTP e.g. BATAP — ARINC 620

ATSEP QUALIFICATION - Streams													ATSEP UID (Unique Objective Identifier)	CORPUS	Tax	CONTENT		
COM-	COM-Data	NAV-NDR	NAV-DE	NAV-VOR	NAV-DMF	NAV-IIS	SLIP-DSP	SLIP-SSR	SLIP-ADS	DPR-DP	SMC-COM	SMC-NAV					SMC-SLIP	SMC-DP
X										X					ATSEP.QLF.COM.DTA_3	NATIONAL NETWORKS		
X										X					ATSEP.QLF.COM.DTA_3.1	National Networks		
ATSEP QUALIFICATION - Streams													ATSEP UID (Unique Objective Identifier)	CORPUS	Tax	CONTENT		
COM-	COM-Data	NAV-NDR	NAV-DE	NAV-VOR	NAV-DMF	NAV-IIS	SLIP-DSP	SLIP-SSR	SLIP-ADS	DPR-DP	SMC-COM	SMC-NAV					SMC-SLIP	SMC-DP
X										X					ATSEP.QLF.COM.DTA_3.1.1	Name the national networks to which the organisation is connected	1	e.g. ANSP, MET, Military, Commercial Telecom providers, airlines, national network(s)
X										X					ATSEP.QLF.COM.DTA_3.1.2	Describe the interfaces between national and global networks	2	-
X											X	X	X	X	ATSEP.QLF.COM.DTA_4	EUROPEAN NETWORKS		
X											X	X	X	X	ATSEP.QLF.COM.DTA_4.1	Network Technologies		
X											X	X	X	X	ATSEP.QLF.COM.DTA_4.1.1	State current and emerging network concepts	1	e.g.as used AMHS, PENS
X											X	X	X	X	ATSEP.QLF.COM.DTA_4.1.2	Describe the characteristics of current networks	2	Surveillance data, flight plan data and AIS networks e.g. OLDI, quality of service, architecture, FMTP, AMHS
X											X	X	X	X	ATSEP.QLF.COM.DTA_5	GLOBAL NETWORKS		
X											X	X	X	X	ATSEP.QLF.COM.DTA_5.1	Networks and Standards		
X											X	X	X	X	ATSEP.QLF.COM.DTA_5.1.1	List the global networks and the standards on which they are based	1	e.g. ICAO for AFTN/CIDIN/AMHS, ICAO for ATN, FANS 1 and FANS A for ACARS applications (SITA and ARINC)
X											X	X	X	X	ATSEP.QLF.COM.DTA_5.2	Global Architecture		

ATSEP QUALIFICATION - Streams														ATSEP UID (Unique Objective Identifier)	CORPUS	Tax	CONTENT	
COM-	COM-Data	NAV-NDR	NAV-DE	NAV-VOR	NAV-DMF	NAV-IIS	SLIP-DCR	SLIP-SSR	SLIP-ADS	DPR-DP	SMC-COM	SMC-NAV	SMC-SLIP					SMC-DP
	X														ATSEP.QLF.COM.DTA_5.2.1	Describe the architecture of the ATN	2	Air-ground subnetworks, ground-ground subnetworks, airborne networks
	X									X	X	X	X	X	ATSEP.QLF.COM.DTA_5.2.2	Describe the SWIM concept	2	Main SWIM Standards, SWIM Profiles, standards & protocols, TCP/IP version, compatibility issues e.g. topology, potential development, challenges (cyber security), opportunities
	X									X	X	X	X	X	ATSEP.QLF.COM.DTA_5.2.3	Describe SWIM data	2	Types of aeronautical data (dynamic, static), other data relevant for aviation e.g. AMHS data, MET data, 4D trajectory data, aerodrome data, flight procedures
	X														ATSEP.QLF.COM.DTA_5.3	Air-ground Subnetworks		
ATSEP QUALIFICATION - Streams														ATSEP UID (Unique Objective Identifier)	CORPUS	Tax	CONTENT	
COM-	COM-Data	NAV-NDR	NAV-DE	NAV-VOR	NAV-DMF	NAV-IIS	SLIP-DCR	SLIP-SSR	SLIP-ADS	DPR-DP	SMC-COM	SMC-NAV	SMC-SLIP					SMC-DP
	X														ATSEP.QLF.COM.DTA_5.3.1	Describe the air-ground subnetworks	2	VDL (mode 2), AMSS
	X														ATSEP.QLF.COM.DTA_5.4	Ground-ground Subnetworks		
	X														ATSEP.QLF.COM.DTA_5.4.1	Describe the composition of ground-ground subnetworks	2	Commercial telecom providers, Rockwell Collins, SITA
	X														ATSEP.QLF.COM.DTA_5.5	Networks On Board of the Aircraft		

ATSEP QUALIFICATION - Streams														ATSEP UID (Unique Objective Identifier)	CORPUS	Tax	CONTENT	
COM-	COM-Data	NAV-NDR	NAV-DE	NAV-VOR	NAV-DMF	NAV-ILS	SLIP-DCR	SLIP-SSR	SLIP-ADS	DPR-DP	SMC-COM	SMC-NAV	SMC-SLR					SMC-DP
	X														ATSEP.QLF.COM.DTA_5.5.1	State the existence of subnetworks inside the aircraft relevant for ATM communications	1	e.g. AFDX — ARINC 429
	X														ATSEP.QLF.COM.DTA_5.6	Air-ground Applications		
	X														ATSEP.QLF.COM.DTA_5.6.1	State the main communication applications using data link systems	1	e.g. CPDLC, DLIC/AFN, ATIS, DCL
X	X	X	X	X	X	X	X	X	X						ATSEP.QLF.COM.TRP	TRANSMISSION PATH		
X	X	X	X	X	X	X	X	X	X						ATSEP.QLF.COM.TRP_1	LINES		
X	X														ATSEP.QLF.COM.TRP_1.1	Lines Theory		
X	X														ATSEP.QLF.COM.TRP_1.1.1	Explain parameters of a line	2	e.g. equation, attenuation, impedance, S- parameters, Smith chart, bandwidth, HF specifics (dipoles, multipoles), SWR
X	X														ATSEP.QLF.COM.TRP_1.2	Digital Transmission		
X	X														ATSEP.QLF.COM.TRP_1.2.1	Describe parameters for digital transmission	2	e.g. signal definition, Fourier Theory, signal processing (sampling, etc.), bandwidth, carrier, modulation, noises, S/N, delays, group delay, line quality (signal distortion, rate of failure), transmission speed
X	X	X	X	X	X	X	X	X	X						ATSEP.QLF.COM.TRP_1.3	Types of Lines		

ATSEP QUALIFICATION - Streams													ATSEP UID (Unique Objective Identifier)	CORPUS	Tax	CONTENT		
COM-	COM-Data	NAV-NDR	NAV-DE	NAV-VOR	NAV-DMF	NAV-IIS	SLIP-DCP	SLIR-SSR	SLIR-ADS	DPR-DP	SMC-COM	SMC-NAV					SMC-SLIR	SMC-DP
X	X	X	X	X	X	X	X	X	X						ATSEP.QLF.COM.TRP_1.3.1	Describe the different types of lines and their physical characteristics	2	e.g. copper wires (twisted pairs, symmetrical cables), optic fibres (mono or multimodes, connectors, splicer), coaxial attenuation, losses, bending, characteristic impedance, EMC and noise immunity, crosstalk
ATSEP QUALIFICATION - Streams													ATSEP UID (Unique Objective Identifier)	CORPUS	Tax	CONTENT		
COM-	COM-Data	NAV-NDR	NAV-DE	NAV-VOR	NAV-DMF	NAV-IIS	SLIP-DCP	SLIR-SSR	SLIR-ADS	DPR-DP	SMC-COM	SMC-NAV					SMC-SLIR	SMC-DP
X	X														ATSEP.QLF.COM.TRP_1.3.2	Consider the appropriate type of line for a given specific application	2	e.g. bandwidth, noise immunity
X	X														ATSEP.QLF.COM.TRP_1.3.3	Describe the typical parameters of lines	2	e.g. impedance, insulation, signal level, time delay
X	X														ATSEP.QLF.COM.TRP_2	SPECIFIC LINKS		
X	X														ATSEP.QLF.COM.TRP_2.1	Microwave Link		
X	X														ATSEP.QLF.COM.TRP_2.1.1	Describe a microwave link	2	e.g. carrier frequency, type of modulation, Fresnel Theory, loss, atmospheric influences
X	X														ATSEP.QLF.COM.TRP_2.2	Satellite		
X	X														ATSEP.QLF.COM.TRP_2.2.1	Describe the parameters of a satellite link	2	Uplinks, downlinks, antennas, footprint, delays, atmospheric influences
X	X										X	X	X	X	ATSEP.QLF.COM.REC	RECORDERS		
X	X										X	X	X	X	ATSEP.QLF.COM.REC_1	LEGAL RECORDERS		

ATSEP QUALIFICATION - Streams														ATSEP UID (Unique Objective Identifier)	CORPUS	Tax	CONTENT	
COM-	COM-Data	NAV-NDR	NAV-DE	NAV-VOR	NAV-DMF	NAV-IIS	SLIP-DCP	SLIR-SSR	SLIR-ADS	DPR-DP	SMC-COM	SMC-NAV	SMC-SLIR					SMC-DP
X	X										X	X	X	X	ATSEP.QLF.COM.REC_1.1	Regulations		
X	X										X	X	X	X	ATSEP.QLF.COM.REC_1.1.1	Explain the international regulations	2	ICAO (recording and reproducing)
X	X										X	X	X	X	ATSEP.QLF.COM.REC_1.1.2	Explain national regulations	2	Appropriate national regulations
X	X										X	X	X	X	ATSEP.QLF.COM.REC_1.1.3	Consider recording and reproducing processes	2	e.g. confidentiality when handling recorders, procedures for access to recorders, storage media, access to recording and reproducing room, time to store information (overwrite/erase voice or data), procedure to reproduce information
X	X										X	X	X	X	ATSEP.QLF.COM.REC_1.2	Principles		
X	X										X	X	X	X	ATSEP.QLF.COM.REC_1.2.1	Explain the principles of voice recording	2	Recording Interfaces, codecs, ambient recording e.g. analogue - A/D converters, E1, VoIP office telephony, VoIP VCS ED-137; A-law, u-law codecs; frequency range (300 to 3400 Hz)
ATSEP QUALIFICATION - Streams														ATSEP UID (Unique Objective Identifier)	CORPUS	Tax	CONTENT	
COM-	COM-Data	NAV-NDR	NAV-DE	NAV-VOR	NAV-DMF	NAV-IIS	SLIP-DCP	SLIR-SSR	SLIR-ADS	DPR-DP	SMC-COM	SMC-NAV	SMC-SLIR					SMC-DP
X	X										X	X	X	X	ATSEP.QLF.COM.REC_1.2.2	Explain the principles of video recording	2	Software recording, hardware recording, evidence

ATSEP QUALIFICATION - Streams														ATSEP UID (Unique Objective Identifier)	CORPUS	Tax	CONTENT	
COM-	COM-Data	NAV-NDR	NAV-DE	NAV-VOR	NAV-DMF	NAV-ILS	SLIP-DCR	SLIP-SSR	SLIP-ADS	DPR-DP	SMC-COM	SMC-NAV	SMC-SLR					SMC-DP
X	X										X	X	X	X	ATSEP.QLF.COM.REC_1.2.3	Explain security of recorded data	2	Confidentiality, protection against tampering, access protection, access logging
X	X										X	X	X	X	ATSEP.QLF.COM.REC_1.2.4	Explain the principles of replay	2	Synchronisation of screen / radar and voice recording, replay limitations e.g. inability of measuring separation on screen replay
		X	X	X	X	X					X	X	X	X	ATSEP.QLF.NAV	ATSEP QUALIFICATION DOMAIN - NAVIGATION		
		X	X	X	X	X					X	X	X	X	ATSEP.QLF.NAV.PBN	PERFORMANCE-BASED NAVIGATION		
		X	X	X	X	X					X	X	X	X	ATSEP.QLF.NAV.PBN_1	NAV CONCEPTS		
		X	X	X	X	X									ATSEP.QLF.NAV.PBN_1.1	Operational Requirements		
		X	X	X	X	X									ATSEP.QLF.NAV.PBN_1.1.1	Explain the main performance characteristics of a navigation system	2	Accuracy, precision, stability, integrity, availability, continuity of service, coverage, robustness e.g. Time To First Fix
		X	X	X	X	X									ATSEP.QLF.NAV.PBN_1.1.2	Explain the relationship between performance measures and the phases of flight	2	PBN Manual ICAO Doc 9613
		X	X	X	X	X									ATSEP.QLF.NAV.PBN_1.2	Performance-based Navigation		
		X	X	X	X	X									ATSEP.QLF.NAV.PBN_1.2.1	Describe the PBN concept	2	ICAO and EUROCONTROL documents, airspace concept, application supported by navigation infrastructure and navigation

ATSEP QUALIFICATION - Streams													ATSEP UID (Unique Objective Identifier)	CORPUS	Tax	CONTENT			
COM-	COM-Data	NAV-NDR	NAV-DE	NAV-VOR	NAV-DMF	NAV-ILS	SLIR-DSP	SLIR-SSR	SLIR-ADS	DPR-DP	SMC-COM	SMC-NAV					SMC-SLIR	SMC-DP	
																			specifications, functionality of the avionics
		X	X	X	X	X										ATSEP.QLF.NAV.PBN_1.2.2	Differentiate between an RNAV and an RNP navigation specification	2	On-Board Performance Monitoring and Alerting
		X	X	X	X	X										ATSEP.QLF.NAV.PBN_1.2.3	State which navigation applications support the different phases of flight	1	PBN Manual ICAO Doc 9613
		X	X	X	X	X										ATSEP.QLF.NAV.PBN_1.2.4	Describe the navigation infrastructure supporting the PBN concept	2	e.g. VOR/DME, DME/DME, ILS, GNSS
ATSEP QUALIFICATION - Streams													ATSEP UID (Unique Objective Identifier)	CORPUS	Tax	CONTENT			
COM-	COM-Data	NAV-NDR	NAV-DE	NAV-VOR	NAV-DMF	NAV-ILS	SLIR-DSP	SLIR-SSR	SLIR-ADS	DPR-DP	SMC-COM	SMC-NAV					SMC-SLIR	SMC-DP	
		X	X	X	X	X										ATSEP.QLF.NAV.PBN_1.3	Area Navigation Concept (RNAV)		
		X	X	X	X	X										ATSEP.QLF.NAV.PBN_1.3.1	Differentiate between conventional navigation and area navigation	2	Fixed route vs flexible route structure
																ATSEP.QLF.NAV.PBN_1.4	NOTAM		
																-	-		-
X												X				ATSEP.QLF.NAV.NDB	GROUND-BASED SYSTEMS - NDB		

ATSEP QUALIFICATION - Streams													ATSEP UID (Unique Objective Identifier)	CORPUS	Tax	CONTENT		
COM-	COM-Data	NAV-NDR	NAV-DE	NAV-VOR	NAV-DMF	NAV-ILS	SLIR-DCR	SLIR-SSR	SLIR-ADS	DPR-DP	SMC-COM	SMC-NAV					SMC-SLR	SMC-DP
		X										X			ATSEP.QLF.NAV.NDB_1	NON-DIRECTIONAL BEACON (NDB)		
		X										X			ATSEP.QLF.NAV.NDB_1.1	Use of the System		
		X										X			ATSEP.QLF.NAV.NDB_1.1.1	Appreciate the principles of NDB	3	Relative bearing, measuring method
		X										X			ATSEP.QLF.NAV.NDB_1.1.2	Describe the overall performance	2	Coverage, accuracy, availability of the system, integrity, continuity
		X										X			ATSEP.QLF.NAV.NDB_1.1.3	Explain the technical limitations of NDB	2	Lack of accuracy, lack of integrity, sensitivity to interference
		X										X			ATSEP.QLF.NAV.NDB_1.1.4	Describe the current situation	2	e.g. number, type, users, user groups, European context
		X													ATSEP.QLF.NAV.NDB_1.2	Ground Station Architecture		
		X													ATSEP.QLF.NAV.NDB_1.2.1	Describe the main components of an NDB ground station	2	Electronic cabinet, antennas, power supply, remote controls and monitoring
		X													ATSEP.QLF.NAV.NDB_1.2.2	Relate NDB station design to operational requirements	4	Coverage, ID code, VOR backup, double beacon approach, siting
		X													ATSEP.QLF.NAV.NDB_1.3	Transmitter Subsystem		
		X													ATSEP.QLF.NAV.NDB_1.3.1	Characterise the main NDB signal parameters	2	Carrier and ident frequency, output power, depth of modulation
		X													ATSEP.QLF.NAV.NDB_1.3.2	Perform typical measurements on the main NDB signal parameters	3	e.g. carrier and ident frequency, power measurements, depth of modulation, audio distortion, antenna current, spectrum measurements, ID code
		X													ATSEP.QLF.NAV.NDB_1.4	Antenna Subsystem		

ATSEP QUALIFICATION - Streams														ATSEP UID (Unique Objective Identifier)	CORPUS	Tax	CONTENT	
COM-	COM-Data	NAV-NDR	NAV-DE	NAV-VOR	NAV-DMF	NAV-IIS	SIIR-DCR	SIIR-SSR	SIIR-ADS	DPR-DP	SMC-COM	SMC-NAV	SMC-SIIR					SMC-DP
		X													ATSEP.QLF.NAV.NDB_1.4.1	Explain NDB antenna characteristics	2	Impedance, polar diagram, polarisation, ground reflections
ATSEP QUALIFICATION - Streams														ATSEP UID (Unique Objective Identifier)	CORPUS	Tax	CONTENT	
COM-	COM-Data	NAV-NDR	NAV-DE	NAV-VOR	NAV-DMF	NAV-IIS	SIIR-DCR	SIIR-SSR	SIIR-ADS	DPR-DP	SMC-COM	SMC-NAV	SMC-SIIR					SMC-DP
		X													ATSEP.QLF.NAV.NDB_1.4.2	Appreciate the interface between power stage and the antenna	3	Antenna tuning units, matching filter, SWR, radiated power
		X													ATSEP.QLF.NAV.NDB_1.5	Monitoring and Control Subsystems		
		X													ATSEP.QLF.NAV.NDB_1.5.1	Describe the purpose of monitoring	2	Integrity, continuity of service, availability
		X													ATSEP.QLF.NAV.NDB_1.5.2	Describe which parameters are used for the monitoring	2	Antenna current, ID code, depth of modulation
		X													ATSEP.QLF.NAV.NDB_1.5.3	Appreciate how the operational status of the NDB monitoring system is checked	3	System status
		X													ATSEP.QLF.NAV.NDB_1.5.4	Describe the issues associated with NDB obstacle limitations and obstacle removal	2	Siting
		X													ATSEP.QLF.NAV.NDB_1.6	On-board Equipment		
		X													ATSEP.QLF.NAV.NDB_1.6.1	Describe the on-board equipment (ADF)	2	Receiver, antenna, displays
		X													ATSEP.QLF.NAV.NDB_1.6.2	Describe how NDB information is used on-board	2	ADF indicator, RMI, HSI, ND

ATSEP QUALIFICATION - Streams														ATSEP UID (Unique Objective Identifier)	CORPUS	Tax	CONTENT	
COM-	COM-Data	NAV-NDR	NAV-DF	NAV-VOR	NAV-DMF	NAV-ILS	SLIP-PCR	SLIP-SSR	SLIP-ADS	DPR-DP	SMC-COM	SMC-NAV	SMC-SLR					SMC-DP
		X													ATSEP.QLF.NAV.NDB_1.7	System Check and Maintenance		
		X													ATSEP.QLF.NAV.NDB_1.7.1	Describe the conformity to international and national regulations	2	ITU regulations (EMC + SAR), ICAO Annex 10 e.g. European regulations
		X													ATSEP.QLF.NAV.NDB_1.7.2	Appreciate calibration tasks and flight inspection results	3	e.g. maintenance and flight inspection manuals, procedures and reports
		X													ATSEP.QLF.NAV.NDB_1.7.3	Appreciate troubleshooting of an NDB	3	e.g. maintenance and flight inspection manuals, procedures and reports
		X													ATSEP.QLF.NAV.NDB_1.7.4	Appreciate the origins of NDB errors	3	e.g. multipath, EMC, interference with radio broadcast transmissions
		X										X			ATSEP.QLF.NAV.DFI	GROUND-BASED SYSTEMS - DF		
		X										X			ATSEP.QLF.NAV.DFI_1	DIRECTION FINDER (DF)		
		X										X			ATSEP.QLF.NAV.DFI_1.1	Use of the System		
ATSEP QUALIFICATION - Streams														ATSEP UID (Unique Objective Identifier)	CORPUS	Tax	CONTENT	
COM-	COM-Data	NAV-NDR	NAV-DF	NAV-VOR	NAV-DMF	NAV-ILS	SLIP-PCR	SLIP-SSR	SLIP-ADS	DPR-DP	SMC-COM	SMC-NAV	SMC-SLR					SMC-DP
		X										X			ATSEP.QLF.NAV.DFI_1.1.1	State the different types of DF	1	VDF, DDF, IDF
		X										X			ATSEP.QLF.NAV.DFI_1.1.2	Describe the user HMI	2	Indication on radar picture, DF indicator
		X										X			ATSEP.QLF.NAV.DFI_1.1.3	Appreciate the principles of DF	3	Bearing, measuring method (standard, Doppler, interferometry)

ATSEP QUALIFICATION - Streams														ATSEP UID (Unique Objective Identifier)	CORPUS	Tax	CONTENT	
COM-	COM-Data	NAV-NDR	NAV-DF	NAV-VOR	NAV-DMF	NAV-ILS	SLIP-DCR	SLIP-SSR	SLIP-ADS	DPR-DP	SMC-COM	SMC-NAV	SMC-SLR					SMC-DP
		X										X			ATSEP.QLF.NAV.DFI_1.1.4	Describe the overall performance	2	Coverage, accuracy, availability of the system, integrity, continuity
		X										X			ATSEP.QLF.NAV.DFI_1.1.5	Explain the technical limitations of DF	2	Sensitivity to interference
		X										X			ATSEP.QLF.NAV.DFI_1.1.6	Describe the current situation	2	e.g. number, type, users, national context
		X													ATSEP.QLF.NAV.DFI_1.2	VDF/DDF Equipment Architecture		
		X													ATSEP.QLF.NAV.DFI_1.2.1	Describe the main components of DF equipment	2	Electronic cabinet, antennas, power supply, remote controls and monitoring
		X													ATSEP.QLF.NAV.DFI_1.3	Receiver Subsystem		
		X													ATSEP.QLF.NAV.DFI_1.3.1	Explain the main signal parameters	2	Frequency band (UHF, VHF)
		X													ATSEP.QLF.NAV.DFI_1.4	Antenna Subsystem		
		X													ATSEP.QLF.NAV.DFI_1.4.1	Explain DF antenna characteristics	2	Impedance, polar diagram, polarisation, types of antennas
		X													ATSEP.QLF.NAV.DFI_1.4.2	Appreciate protection areas	3	Obstacles, ICAO Annex 10 e.g. manufacturers manuals
		X													ATSEP.QLF.NAV.DFI_1.5	Monitoring and Control Subsystems		
		X													ATSEP.QLF.NAV.DFI_1.5.1	Describe the purpose of monitoring	2	Integrity, continuity of service, availability
		X													ATSEP.QLF.NAV.DFI_1.5.2	Describe which parameters are used for the monitoring	2	Noise figure, stability of measurement

ATSEP QUALIFICATION - Streams														ATSEP UID (Unique Objective Identifier)	CORPUS	Tax	CONTENT	
COM-	COM-Data	NAV-NDR	NAV-DE	NAV-VOR	NAV-DMF	NAV-ILS	SLIP-DSP	SLIR-SSR	SLIR-ADS	DPR-DP	SMC-COM	SMC-NAV	SMC-SLIR					SMC-DP
		X													ATSEP.QLF.NAV.DFI_1.5.3	Appreciate how the operational status of the DF monitoring system is checked	3	System status
		X													ATSEP.QLF.NAV.DFI_1.5.4	Describe the issues associated with DF obstacle limitations and obstacle removal	2	Surrounding environment, protection of bearing accuracy
		X													ATSEP.QLF.NAV.DFI_1.6	System Check and Maintenance		
ATSEP QUALIFICATION - Streams														ATSEP UID (Unique Objective Identifier)	CORPUS	Tax	CONTENT	
COM-	COM-Data	NAV-NDR	NAV-DE	NAV-VOR	NAV-DMF	NAV-ILS	SLIP-DSP	SLIR-SSR	SLIR-ADS	DPR-DP	SMC-COM	SMC-NAV	SMC-SLIR					SMC-DP
		X													ATSEP.QLF.NAV.DFI_1.6.1	Describe the conformity to international and national regulations	2	ITU regulations (EMV + SAR), ICAO Annex 10 e.g. European regulations
		X													ATSEP.QLF.NAV.DFI_1.6.2	Perform typical measurements on a DF system	3	Frequency, channel spacing, sensitivity, selectivity, bearing accuracy
		X													ATSEP.QLF.NAV.DFI_1.6.3	Appreciate calibration tasks and flight inspection results	3	Ground-based bearing checks, test oscillator e.g. North setting, range, multipath maintenance and flight inspection manuals, procedures and reports

ATSEP QUALIFICATION - Streams													ATSEP UID (Unique Objective Identifier)	CORPUS	Tax	CONTENT		
COM-	COM-Data	NAV-NDR	NAV-DF	NAV-VOR	NAV-DMF	NAV-ILS	SLIP-DSP	SLIP-SSR	SLIP-ADS	DPR-DP	SMC-COM	SMC-NAV					SMC-SLR	SMC-DP
			X												ATSEP.QLF.NAV.DFI_1.6.4	Appreciate troubleshooting of DF	3	e.g. sensitivity, local oscillator level Maintenance and flight inspection manuals, procedures and reports
			X												ATSEP.QLF.NAV.DFI_1.6.5	Appreciate the origin of DF errors	3	e.g. multipath, EMC, interference with radio broadcast transmissions
			X									X			ATSEP.QLF.NAV.VOR	GROUND-BASED SYSTEMS - VOR		
			X									X			ATSEP.QLF.NAV.VOR_1	VHF OMNIDIRECTIONAL RADIO RANGE (VOR)		
			X									X			ATSEP.QLF.NAV.VOR_1.1	Use of the System		
			X									X			ATSEP.QLF.NAV.VOR_1.1.1	State the types of VOR Systems	1	Conventional, Doppler
			X									X			ATSEP.QLF.NAV.VOR_1.1.2	Describe the overall performance	2	Coverage, accuracy, availability of the system, integrity, continuity
			X									X			ATSEP.QLF.NAV.VOR_1.1.3	Explain the technical limitations of CVOR	2	Type of information (azimuth), accuracy, integrity, suitable for a network of fixed routes
			X									X			ATSEP.QLF.NAV.VOR_1.1.4	Appreciate the differences between CVOR and DVOR	3	Signal broadcast differences, bearing information robustness
			X									X			ATSEP.QLF.NAV.VOR_1.1.5	Describe the current situation	2	e.g. number, type, users, user groups, national context, European context
			X												ATSEP.QLF.NAV.VOR_1.2	Fundamentals of CVOR and/or DVOR		
			X												ATSEP.QLF.NAV.VOR_1.2.1	Appreciate the mathematical signal description	3	Declination, equations of CVOR and/or DVOR, reference and variable signals
ATSEP QUALIFICATION - Streams													ATSEP UID	CORPUS		CONTENT		

ATSEP QUALIFICATION - Streams													ATSEP UID (Unique Objective Identifier)	CORPUS	Tax	CONTENT		
COM-	COM-Data	NAV-ADR	NAV-DE	NAV-VOR	NAV-DMF	NAV-ILS	SLIP-DCR	SLIP-SSR	SLIP-ADS	DPR-DP	SMC-COM	SMC-NAV					SMC-SLR	SMC-DP
				X											ATSEP.QLF.NAV.VOR_1.2.2	Appreciate the principles for generating the variable signal	3	CVOR Rotating antennae principle Generating a rotating radiation pattern with static antennae and/or DVOR Frequency modulation through switching antenna
				X											ATSEP.QLF.NAV.VOR_1.3	Ground Station Architecture		
				X											ATSEP.QLF.NAV.VOR_1.3.1	Describe the main components of a CVOR and/or DVOR ground station	2	Electronic cabinet, antenna system, power supply, remote controls and monitoring
				X											ATSEP.QLF.NAV.VOR_1.3.2	Identify the relation between VOR station design and the operational requirements	4	Siting, coverage, ID code, backup systems
				X											ATSEP.QLF.NAV.VOR_1.4	Transmitter Subsystem		
				X											ATSEP.QLF.NAV.VOR_1.4.1	Characterise main signal parameters for a CVOR and/or DVOR	2	Carrier frequency stability, output power, signals generated
				X											ATSEP.QLF.NAV.VOR_1.4.2	Perform typical transmitter measurements on VOR signals	3	Radiation pattern accuracy, power and modulation measurements, spectrum measurements, ID coding
				X											ATSEP.QLF.NAV.VOR_1.5	Antenna Subsystem		
				X											ATSEP.QLF.NAV.VOR_1.5.1	Explain VOR antenna characteristics	2	Impedance, polar diagram, polarisation, types of antennas

ATSEP QUALIFICATION - Streams														ATSEP UID (Unique Objective Identifier)	CORPUS	Tax	CONTENT	
COM-	COM-Data	NAV-NDR	NAV-DE	NAV-VOR	NAV-DMF	NAV-ILS	SLIP-DSP	SLIR-SSR	SLIR-ADS	DPR-DP	SMC-COM	SMC-NAV	SMC-SIR					SMC-DP
				X											ATSEP.QLF.NAV.VOR_1.5.2	Appreciate the interface between power stage and the antennae	3	SWR, radiated power
				X											ATSEP.QLF.NAV.VOR_1.5.3	Appreciate protection areas	3	Obstacles, ICAO Annex 10 e.g. manufacturers manuals
				X											ATSEP.QLF.NAV.VOR_1.6	Monitoring and Control Subsystem		
				X											ATSEP.QLF.NAV.VOR_1.6.1	Describe the purpose of monitoring	2	Integrity, continuity of service, availability
				X											ATSEP.QLF.NAV.VOR_1.6.2	Describe which VOR parameters are monitored	2	ICAO and RTCA/EUROCAE requirements e.g. NSA requirements
				X											ATSEP.QLF.NAV.VOR_1.6.3	Describe the principles of the CVOR and/or DVOR monitoring systems	2	Near field sensors, far field sensors, Local and remote monitoring
ATSEP QUALIFICATION - Streams														ATSEP UID (Unique Objective Identifier)	CORPUS	Tax	CONTENT	
COM-	COM-Data	NAV-NDR	NAV-DE	NAV-VOR	NAV-DMF	NAV-ILS	SLIP-DSP	SLIR-SSR	SLIR-ADS	DPR-DP	SMC-COM	SMC-NAV	SMC-SIR					SMC-DP
				X											ATSEP.QLF.NAV.VOR_1.6.4	Appreciate how the operational status of the CVOR and/or DVOR monitoring systems are checked	3	Near field sensors, far field sensors, recombination, Local and remote monitoring e.g. BITE, Watchdog
				X											ATSEP.QLF.NAV.VOR_1.6.5	Describe the issues associated with VOR obstacle limitations and obstacle removal	2	Surrounding environment, multipath prevention
				X											ATSEP.QLF.NAV.VOR_1.7	On-board Equipment		

ATSEP QUALIFICATION - Streams													ATSEP UID (Unique Objective Identifier)	CORPUS	Tax	CONTENT		
COM-	COM-Data	NAV-NDR	NAV-DE	NAV-VOR	NAV-DMF	NAV-IIS	SLIP-DSP	SLIP-SSR	SLIP-ADS	DPR-DP	SMC-COM	SMC-NAV					SMC-SLIP	SMC-DP
				X											ATSEP.QLF.NAV.VOR_1.7.1	Describe the on-board equipment	2	Antenna, receiver HMI e.g. CDI, RMI, HSI, ND
				X											ATSEP.QLF.NAV.VOR_1.7.2	Describe how the VOR information is used on board	2	e.g. single VOR, VOR-VOR, approach procedures, manual mode, automatic mode
				X											ATSEP.QLF.NAV.VOR_1.8	System Check and Maintenance		
				X											ATSEP.QLF.NAV.VOR_1.8.1	Describe the conformity to international and national regulations	2	ITU regulations (EMC + SAR), ICAO Annex 10
				X											ATSEP.QLF.NAV.VOR_1.8.2	Perform typical system measurements	3	In space modulation, phase sideband/carrier, ground check for bearing errors
				X											ATSEP.QLF.NAV.VOR_1.8.3	Appreciate calibration tasks and flight inspection results	3	Flight inspection (coverage, flight check for bearing errors and modulation) e.g. maintenance manuals, procedures and reports
				X											ATSEP.QLF.NAV.VOR_1.8.4	Appreciate troubleshooting of a CVOR and/or DVOR	3	Carrier frequency deviation, depth of modulation, lack of power, harmonics ratio e.g. maintenance and flight inspection manuals, procedures and reports
ATSEP QUALIFICATION - Streams													ATSEP UID (Unique Objective Identifier)	CORPUS	Tax	CONTENT		
COM-	COM-Data	NAV-NDR	NAV-DE	NAV-VOR	NAV-DMF	NAV-IIS	SLIP-DSP	SLIP-SSR	SLIP-ADS	DPR-DP	SMC-COM	SMC-NAV					SMC-SLIP	SMC-DP

ATSEP QUALIFICATION - Streams													ATSEP UID (Unique Objective Identifier)	CORPUS	Tax	CONTENT		
COM-	COM-Data	NAV-NDR	NAV-DE	NAV-VOR	NAV-DMF	NAV-ILS	SLIR-DCR	SLIR-SSR	SLIR-ADS	DPR-DP	SMC-COM	SMC-NAV					SMC-SLR	SMC-DP
				X											ATSEP.QLF.NAV.VOR_1.8.5	Analyse the origins of CVOR and/or DVOR errors	4	CVOR System-dependent, adjustments, drifts, multipath, on-board errors and/or DVOR North Adjustment e.g. DVOR: antenna feeding DVOR and CVOR: multipath, EMC, interference with radio broadcast transmissions
				X								X			ATSEP.QLF.NAV.DME	GROUND-BASED SYSTEMS - DME		
				X								X			ATSEP.QLF.NAV.DME_1	DISTANCE MEASURING EQUIPMENT (DME)		
				X								X			ATSEP.QLF.NAV.DME_1.1	Use of the System		
				X								X			ATSEP.QLF.NAV.DME_1.1.1	Describe the overall performances for DME	2	Coverage, accuracy, availability of the system, integrity, continuity, number of users
				X								X			ATSEP.QLF.NAV.DME_1.1.2	Explain the limitations of DME	2	Accuracy, integrity, capacity
				X								X			ATSEP.QLF.NAV.DME_1.1.3	Describe the current situation	2	e.g. number, types, users, user groups, national context, European context
				X								X			ATSEP.QLF.NAV.DME_1.1.4	State the role of the DME infrastructure in the future navigation applications	1	PBN
				X								X			ATSEP.QLF.NAV.DME_1.1.5	Explain the differences between DME and TACAN for civilian use	2	e.g. azimuth and range
				X											ATSEP.QLF.NAV.DME_1.2	Fundamentals of DME		
				X											ATSEP.QLF.NAV.DME_1.2.1	Describe the key elements of DME system operation	2	Two-way ranging technique, slant range, time measurement A/C interrogation, pulse pairs, ground

ATSEP QUALIFICATION - Streams														ATSEP UID (Unique Objective Identifier)	CORPUS	Tax	CONTENT	
COM-	COM-Data	NAV-NDR	NAV-DE	NAV-VOR	NAV-DMF	NAV-ILS	SLIP-DSP	SLIR-SSR	SLIR-ADS	DPR-DP	SMC-COM	SMC-NAV	SMC-SLIR					SMC-DP
																		reply, fixed time delay, interrogation stagger, 'X' and 'Y' channels
					X										ATSEP.QLF.NAV.DME_1.2.2	Explain the frequency spectrum and the channel spacing allocated	2	ICAO Annex 10, EUROCAE ED-57, L-band
					X										ATSEP.QLF.NAV.DME_1.3	Ground Station Architecture		
					X										ATSEP.QLF.NAV.DME_1.3.1	Describe the main components of a DME ground station	2	Electronic cabinet, antenna system, power supply, remote controls and monitoring
ATSEP QUALIFICATION - Streams														ATSEP UID (Unique Objective Identifier)	CORPUS	Tax	CONTENT	
COM-	COM-Data	NAV-NDR	NAV-DE	NAV-VOR	NAV-DMF	NAV-ILS	SLIP-DSP	SLIR-SSR	SLIR-ADS	DPR-DP	SMC-COM	SMC-NAV	SMC-SLIR					SMC-DP
					X										ATSEP.QLF.NAV.DME_1.3.2	Identify the relation between DME station design and the operational requirements	3	Coverage, ID code, siting
					X										ATSEP.QLF.NAV.DME_1.4.1	Explain the main receiver parameters for a DME	2	Sensitivity, selectivity, dynamic range, jamming immunity
					X										ATSEP.QLF.NAV.DME_1.4.2	Appreciate the typical measurements on the interrogation signals	3	Sensitivity, selectivity, dynamic range, jamming immunity
					X										ATSEP.QLF.NAV.DME_1.5	Signal Processing		

ATSEP QUALIFICATION - Streams													ATSEP UID (Unique Objective Identifier)	CORPUS	Tax	CONTENT		
COM-	COM-Data	NAV-NDR	NAV-DE	NAV-VOR	NAV-DMF	NAV-ILS	SLIP-DCR	SLIP-SSR	SLIP-ADS	DPR-DP	SMC-COM	SMC-NAV					SMC-SLR	SMC-DP
					X										ATSEP.QLF.NAV.DME_1.5.1	Explain the functions performed by a DME signal processor	2	Decode, reply delay, automatic reply rate control, encode, priority (Ident, DME signal, squitter)
					X										ATSEP.QLF.NAV.DME_1.5.2	Appreciate the typical measurement on the DME transponder signals	3	Reply delay, Reply delay offset, decode parameters, rate of replies
					X										ATSEP.QLF.NAV.DME_1.6	Transmitter Subsystem		
					X										ATSEP.QLF.NAV.DME_1.6.1	Characterise the main signal parameters from the ground station	2	Carrier frequency, output power, pulse shape, pulse spacing, pulse repetition frequency, main delay, ID code
					X										ATSEP.QLF.NAV.DME_1.6.2	Appreciate the typical measurements on a DME	3	Power and pulse measurements, spectrum measurements, modulation measurements
					X										ATSEP.QLF.NAV.DME_1.7	Antenna Subsystem		
					X										ATSEP.QLF.NAV.DME_1.7.1	Explain DME antenna characteristics	2	Patterns, antennas
					X										ATSEP.QLF.NAV.DME_1.7.2	Appreciate the interface between power stage and the antenna	3	SWR, radiated power, propagation delay, distribution circuit (e.g. duplexer, circulator)
					X										ATSEP.QLF.NAV.DME_1.7.3	Appreciate protection areas	3	ICAO Annex 10, protection area criteria and enforcement e.g. manufacturers manuals
					X										ATSEP.QLF.NAV.DME_1.8	Monitoring and Control Subsystem		

ATSEP QUALIFICATION - Streams														ATSEP UID (Unique Objective Identifier)	CORPUS	Tax	CONTENT	
COM-	COM-Data	NAV-NDR	NAV-DE	NAV-VOR	NAV-DMF	NAV-IIS	SIIR-PCR	SIIR-SSR	SIIR-ADS	DPR-DP	SMC-COM	SMC-NAV	SMC-SIIR					SMC-DP
					X										ATSEP.QLF.NAV.DME_1.8.1	Describe the purpose of monitoring	2	Integrity, continuity of service, availability
ATSEP QUALIFICATION - Streams														ATSEP UID (Unique Objective Identifier)	CORPUS	Tax	CONTENT	
COM-	COM-Data	NAV-NDR	NAV-DE	NAV-VOR	NAV-DMF	NAV-IIS	SIIR-PCR	SIIR-SSR	SIIR-ADS	DPR-DP	SMC-COM	SMC-NAV	SMC-SIIR					SMC-DP
					X										ATSEP.QLF.NAV.DME_1.8.2	Describe which DME parameters are monitored	2	ICAO and RTCA/EUROCAE requirements e.g. NSA requirements
					X										ATSEP.QLF.NAV.DME_1.8.3	Appreciate how the operational status of the DME monitoring system is checked	3	-
					X										ATSEP.QLF.NAV.DME_1.8.4	Describe the issues associated with DME obstacle limitations and obstacle removal	2	Multipath, blanking
					X										ATSEP.QLF.NAV.DME_1.9	On-board Equipment		
					X										ATSEP.QLF.NAV.DME_1.9.1	Describe the on-board equipment	2	Transmitter, antenna, receiver, HMI e.g. HSI, DME range indication, ND
					X										ATSEP.QLF.NAV.DME_1.9.2	Describe how the DME information is used on board	2	e.g. single DME, multi-DME navigation (rho rho), approach procedures, manual mode, automatic mode
					X										ATSEP.QLF.NAV.DME_1.10	System Check and Maintenance		
					X										ATSEP.QLF.NAV.DME_1.10.1	Describe the conformity to international and national regulations	2	ITU regulations (EMC + SAR), ICAO Annex 10 e.g. European regulations

ATSEP QUALIFICATION - Streams													ATSEP UID (Unique Objective Identifier)	CORPUS	Tax	CONTENT		
COM-	COM-Data	NAV-NDR	NAV-DE	NAV-VOR	NAV-DMF	NAV-ILS	SLIR-DSP	SLIR-SSR	SLIR-ADS	DPR-DP	SMC-COM	SMC-NAV					SMC-SLIR	SMC-DP
					X										ATSEP.QLF.NAV.DME_1.10.2	Appreciate calibration tasks and flight inspection results	3	e.g. maintenance and flight inspection manuals, procedures and reports
					X										ATSEP.QLF.NAV.DME_1.10.3	Appreciate troubleshooting of a DME	3	Carrier frequency deviation, depth of modulation, lack of power, harmonics ratio e.g. main delay and monitor shutdown errors, interference Maintenance and flight inspection manuals, procedures and reports
					X										ATSEP.QLF.NAV.DME_1.10.4	Appreciate the origin of DME errors	3	e.g. Multipath, EMC, interference with radio broadcast transmissions (harmonics)
					X							X			ATSEP.QLF.NAV.ILS	GROUND-BASED SYSTEMS - ILS		
					X							X			ATSEP.QLF.NAV.ILS_1	INSTRUMENT LANDING SYSTEM (ILS)		
					X							X			ATSEP.QLF.NAV.ILS_1.1	Use of the System		
ATSEP QUALIFICATION - Streams													ATSEP UID (Unique Objective Identifier)	CORPUS	Tax	CONTENT		
COM-	COM-Data	NAV-NDR	NAV-DE	NAV-VOR	NAV-DMF	NAV-ILS	SLIR-DSP	SLIR-SSR	SLIR-ADS	DPR-DP	SMC-COM	SMC-NAV					SMC-SLIR	SMC-DP
					X							X			ATSEP.QLF.NAV.ILS_1.1.1	Describe the overall performance for ILS	2	ICAO Annexes 10 and 14 Coverage, accuracy, availability of the system, integrity, continuity, number of users
					X							X			ATSEP.QLF.NAV.ILS_1.1.2	Explain the limitations of ILS	2	ICAO Annexes 10 and 14 Only 40 channels, no segmented paths of

ATSEP QUALIFICATION - Streams													ATSEP UID (Unique Objective Identifier)	CORPUS	Tax	CONTENT		
COM-	COM-Data	NAV-NDR	NAV-DE	NAV-VOR	NAV-DMF	NAV-ILS	SLIP-DCR	SLIP-SSR	SLIP-ADS	DPR-DP	SMC-COM	SMC-NAV					SMC-SLR	SMC-DP
																		approach, beam corruption due to multipath
						X						X			ATSEP.QLF.NAV.ILS_1.1.3	Explain ILS facility performance categories	2	ICAO Annexes 10 and 14 Cat I, Cat II, Cat III Different operational category depending on operational minima, equipment and airport facilities
						X						X			ATSEP.QLF.NAV.ILS_1.1.4	Explain the importance and need for ILS obstacle-free zones	2	ICAO Annexes 10 and 14 Dimensions ILS beam protection, increased significance during LVP conditions e.g. national regulations
						X						X			ATSEP.QLF.NAV.ILS_1.1.5	Consider the need for ATC ILS status indications	2	No continuous monitoring by ATSEP
						X						X			ATSEP.QLF.NAV.ILS_1.1.6	Explain the current situation	2	e.g. number, type, users, national context
						X									ATSEP.QLF.NAV.ILS_1.2	Fundamentals of ILS		
						X									ATSEP.QLF.NAV.ILS_1.2.1	Explain how to obtain a change in depth of modulation of an amplitude-modulated signal as a function of angular position	2	Addition of a carrier signal and a side band signal in space
						X									ATSEP.QLF.NAV.ILS_1.2.2	Characterise the signals to be radiated	2	Amplitude and phase relationship, antenna systems
						X									ATSEP.QLF.NAV.ILS_1.2.3	Appreciate the relation between adjustment of signals generated and the resulting beam patterns and standards	3	Phases and amplitudes in antenna array, modulations on carrier signal, phase and amplitude of side band

ATSEP QUALIFICATION - Streams													ATSEP UID (Unique Objective Identifier)	CORPUS	Tax	CONTENT		
COM-	COM-Data	NAV-NDR	NAV-DE	NAV-VOR	NAV-DMF	NAV-ILS	SLIP-DSP	SLIP-SSR	SLIP-ADS	DPR-DP	SMC-COM	SMC-NAV					SMC-SLIP	SMC-DP
						X									ATSEP.QLF.NAV.ILS_1.2.4	Describe the required performance of an antenna array	2	Beam bend potential, coverage, impact on location of critical and sensitive area
ATSEP QUALIFICATION - Streams													ATSEP UID (Unique Objective Identifier)	CORPUS	Tax	CONTENT		
COM-	COM-Data	NAV-NDR	NAV-DE	NAV-VOR	NAV-DMF	NAV-ILS	SLIP-DSP	SLIP-SSR	SLIP-ADS	DPR-DP	SMC-COM	SMC-NAV					SMC-SLIP	SMC-DP
						X									ATSEP.QLF.NAV.ILS_1.3	2F-Systems		
						X									ATSEP.QLF.NAV.ILS_1.3.1	Explain the limitations of a 1F system	2	Multipath in adverse environment and terrain
						X									ATSEP.QLF.NAV.ILS_1.3.2	Describe the capture effect	2	Capture effect in receiver circuits and its consequences on monitoring
						X									ATSEP.QLF.NAV.ILS_1.3.3	Explain radiation parameters for 2F- LOC and 2F-GP	2	Types of antenna arrays, patterns, coverage, signal distribution, radiated power and their consequences on monitoring
						X									ATSEP.QLF.NAV.ILS_1.4	Ground Station Architecture		
						X									ATSEP.QLF.NAV.ILS_1.4.1	Describe the layout of an ILS	2	-
						X									ATSEP.QLF.NAV.ILS_1.4.2	Describe the main components of the LOC (1F and 2F), GP (1F and 2F), markers and field monitors	2	Electronic cabinet, antennas, power supply, remote controls and monitoring, tower indication e.g. DME
						X									ATSEP.QLF.NAV.ILS_1.4.3	Identify the relation between an ILS station design and operational requirements	3	Coverage, ID code, siting

ATSEP QUALIFICATION - Streams													ATSEP UID (Unique Objective Identifier)	CORPUS	Tax	CONTENT		
COM-	COM-Data	NAV-NDR	NAV-DE	NAV-VOR	NAV-DMF	NAV-ILS	SLIP-DCR	SLIR-SSR	SLIR-ADS	DPR-DP	SMC-COM	SMC-NAV					SMC-SLIR	SMC-DP
						X									ATSEP.QLF.NAV.ILS_1.4.4	Explain the optional DME interface	2	Identity coding ratio
						X									ATSEP.QLF.NAV.ILS_1.5	Transmitter Subsystem		
						X									ATSEP.QLF.NAV.ILS_1.5.1	Appreciate main signal parameters for LOC (1F and 2F), GP (1F and 2F) and markers	2	Carrier frequency, output power, signals generated
						X									ATSEP.QLF.NAV.ILS_1.5.2	Explain the block diagram of the ILS transmitters	4	LOC, GP, Marker beacons Synthesizer, modulator, power amplifier, control coupler, RF changeover
						X									ATSEP.QLF.NAV.ILS_1.6	Antenna Subsystem		
						X									ATSEP.QLF.NAV.ILS_1.6.1	Explain ILS antenna characteristics: LOC, GP and Marker Beacons	2	Types, position, polarisation, patterns, coverage, antenna matching, distribution circuits, radiated power, ground reflection
						X									ATSEP.QLF.NAV.ILS_1.7	Monitoring and Control Subsystem		
ATSEP QUALIFICATION - Streams													ATSEP UID (Unique Objective Identifier)	CORPUS	Tax	CONTENT		
COM-	COM-Data	NAV-NDR	NAV-DE	NAV-VOR	NAV-DMF	NAV-ILS	SLIP-DCR	SLIR-SSR	SLIR-ADS	DPR-DP	SMC-COM	SMC-NAV					SMC-SLIR	SMC-DP
						X									ATSEP.QLF.NAV.ILS_1.7.1	Describe the purpose of monitoring	2	Integrity, continuity of service, availability
						X									ATSEP.QLF.NAV.ILS_1.7.2	Describe the parameters for the monitoring according to ICAO	2	RF level, DDM, SDM on position and width

ATSEP QUALIFICATION - Streams														ATSEP UID (Unique Objective Identifier)	CORPUS	Tax	CONTENT	
COM-	COM-Data	NAV-NDR	NAV-DE	NAV-VOR	NAV-DMF	NAV-ILS	SLIP-DCR	SLIP-SSR	SLIP-ADS	DPR-DP	SMC-COM	SMC-NAV	SMC-SLR					SMC-DP
																Annex 10: LOC, GP and Marker Beacons		
						X									ATSEP.QLF.NAV.ILS_1.7.3	Explain the key additional required monitoring: LOC and GP	2	External, internal and integral monitoring
						X									ATSEP.QLF.NAV.ILS_1.7.4	Explain the purpose, advantages and disadvantages of the FFM system	2	e.g. content position, width, requirement for Cat III operations (some States)
						X									ATSEP.QLF.NAV.ILS_1.7.5	Describe (with a diagram) the monitoring system: LOC, GP, FFM and Marker Beacons	2	Near-field, integral network, internal network, monitor signal processor e.g. DME
						X									ATSEP.QLF.NAV.ILS_1.8	On-board Equipment		
						X									ATSEP.QLF.NAV.ILS_1.8.1	Describe the on-board equipment associated with LOC, GP and Marker Beacon	2	Antennas, receiver, pilot interface (cross pointer) e.g. FMS
						X									ATSEP.QLF.NAV.ILS_1.8.2	Describe how ILS information is used on board	2	e.g. approach procedures, landing, roll-out, manual, automatic mode (auto-pilot)
						X									ATSEP.QLF.NAV.ILS_1.9	System Check and Maintenance		
						X									ATSEP.QLF.NAV.ILS_1.9.1	Describe the conformity of LOC, GP and marker beacons to international and national regulations	2	ITU regulations (EMC + SAR), ICAO Annex 10 e.g. European regulations

ATSEP QUALIFICATION - Streams													ATSEP UID (Unique Objective Identifier)	CORPUS	Tax	CONTENT		
COM-	COM-Data	NAV-NDR	NAV-DE	NAV-VOR	NAV-DMF	NAV-ILS	SLIP-DSP	SLIR-SSR	SLIR-ADS	DPR-DP	SMC-COM	SMC-NAV					SMC-SLIR	SMC-DP
						X									ATSEP.QLF.NAV.ILS_1.9.2	Explain the occasions when it is necessary to downgrade an ILS facility performance category	2	e.g. system failures, environmental changes/disturbance
						X									ATSEP.QLF.NAV.ILS_1.9.3	Explain the implications of ILS facility performance categories to the pilot	2	Link with prevailing Instrument RVR, weather dictating decision height
						X									ATSEP.QLF.NAV.ILS_1.9.4	Perform some typical measurements	3	Output power, spectrum analysis, modulation, ID code
ATSEP QUALIFICATION - Streams													ATSEP UID (Unique Objective Identifier)	CORPUS	Tax	CONTENT		
COM-	COM-Data	NAV-NDR	NAV-DE	NAV-VOR	NAV-DMF	NAV-ILS	SLIP-DSP	SLIR-SSR	SLIR-ADS	DPR-DP	SMC-COM	SMC-NAV					SMC-SLIR	SMC-DP
						X									ATSEP.QLF.NAV.ILS_1.9.5	Appreciate calibration tasks and flight inspection results	3	LOC, GP and marker beacons Flight inspection and ground calibration results, LOC Centreline measurement, width and centreline field measurements e.g. RF interference monitoring maintenance and flight inspection manuals, procedures and reports

ATSEP QUALIFICATION - Streams													ATSEP UID (Unique Objective Identifier)	CORPUS	Tax	CONTENT		
COM-	COM-Data	NAV-NDR	NAV-DE	NAV-VOR	NAV-DMF	NAV-ILS	SLIR-DCR	SLIR-SSR	SLIR-ADS	DPR-DP	SMC-COM	SMC-NAV					SMC-SLR	SMC-DP
						X									ATSEP.QLF.NAV.ILS_1.9.6	Appreciate troubleshooting of ILS LOC, GP and marker beacons	3	DDM and SDM misalignment, coverage pilot reported errors, field checks, monitor checks e.g. lack of power, carrier frequency deviation, harmonic ratio, depth of modulation maintenance and flight inspection manuals, procedures and reports
						X									ATSEP.QLF.NAV.ILS_1.9.7	Appreciate the origin of ILS errors	3	e.g. Multipath, EMC, interference with radio broadcast transmissions (harmonics)
		X	X	X	X	X									ATSEP.QLF.NAV.GNS	GLOBAL NAVIGATION SATELLITE SYSTEM		
		X	X	X	X	X									ATSEP.QLF.NAV.GNS_1	GLOBAL NAVIGATION SATELLITE SYSTEM (GNSS)		
		X	X	X	X	X									ATSEP.QLF.NAV.GNS_1.1	General View		
		X	X	X	X	X									ATSEP.QLF.NAV.GNS_1.1.1	Explain the importance of continuing the development of GNSS in aviation	2	ICAO Doc 9849, SESAR ATM Master Plan, EU Navigation Strategy
		X	X	X	X	X									ATSEP.QLF.NAV.GNS_1.1.2	Describe the elements of GNSS within Europe	2	Core systems : GPS, GLONASS, GALILEO, BEIDOU, Augmentations e.g. Augmentation systems: RAIM, AAIM, EGNOS, WAAS, GBA
		X	X	X	X	X									ATSEP.QLF.NAV.GNS_1.1.3	Appreciate the sources of interference to GNSS signals	3	Intentional, unintentional, ionospheric interference, solar activity, jamming, spoofing
ATSEP QUALIFICATION - Streams													ATSEP UID	CORPUS		CONTENT		

ATSEP QUALIFICATION - Streams														ATSEP UID (Unique Objective Identifier)	CORPUS	Tax	CONTENT	
COM-	COM-Data	NAV-NDR	NAV-DE	NAV-VOR	NAV-DMF	NAV-ILS	SIIP-DCR	SIIR-SSR	SIIR-ADS	DPR-DP	SMC-COM	SMC-NAV	SMC-SIIR					SMC-DP
		X	X	X	X	X									ATSEP.QLF.NAV.GNS_1.1.4	Explain who has responsibility for GNSS oversight in your State and how it is carried out	2	e.g. EASA, GSA, NSA, ANSP
		X	X	X	X	X									ATSEP.QLF.NAV.GNS_1.1.5	Appreciate the impact of the modernisation of GNSS on the ARNS bands	3	Introduction of L5, E5A, E5B
		X	X	X	X	X									ATSEP.QLF.NAV.GNS_1.1.6	Describe the purpose of the GNSS NOTAM	2	ICAO Annex 10, Vol. 1 e.g. AUGUR
		X	X	X	X	X									ATSEP.QLF.NAV.OBE	ON-BOARD EQUIPMENT		
		X	X	X	X	X									ATSEP.QLF.NAV.OBE_1	ON-BOARD SYSTEMS		
		X	X	X	X	X									ATSEP.QLF.NAV.OBE_1.1	On-board Systems		
		X	X	X	X	X									ATSEP.QLF.NAV.OBE_1.1.1	Explain the purpose and use of a navigation computer	2	Sensors, navigation database
		X	X	X	X	X									ATSEP.QLF.NAV.OBE_1.1.2	Explain the purpose and use of an FMS	2	Sensors, navigation database, path steering, displays
		X	X	X	X	X									ATSEP.QLF.NAV.OBE_2	AUTONOMOUS NAVIGATION		
		X	X	X	X	X									ATSEP.QLF.NAV.OBE_2.1	Inertial Navigation		
		X	X	X	X	X									ATSEP.QLF.NAV.OBE_2.1.1	Describe the principles and key features of INS/IRS navigation	2	Gyros, accelerometer, accuracy, drift, updating
		X	X	X	X	X									ATSEP.QLF.NAV.OBE_3	VERTICAL NAVIGATION		
		X	X	X	X	X									ATSEP.QLF.NAV.OBE_3.1	Vertical Navigation		

ATSEP QUALIFICATION - Streams													ATSEP UID (Unique Objective Identifier)	CORPUS	Tax	CONTENT			
COM-	COM-Data	NAV-NDR	NAV-DE	NAV-VOR	NAV-DMF	NAV-IIS	SLIP-PSR	SLIP-SSR	SLIP-ADS	DPR-DP	SMC-COM	SMC-NAV					SMC-SLR	SMC-DP	
		X	X	X	X	X										ATSEP.QLF.NAV.OBE_3.1.1	Describe the different types of vertical sensors and their limitations	2	Barometric, Radio Altimetry, Geodetic e.g. air data computers, manual intervention, dynamic information (AGL), undulation (WGS84)
							X			X		X	X			ATSEP.QLF.SUR	ATSEP QUALIFICATION DOMAIN - SURVEILLANCE		
							X			X		X	X			ATSEP.QLF.SUR.PSR	PRIMARY SURVEILLANCE RADAR (PSR)		
							X			X		X	X			ATSEP.QLF.SUR.PSR_1	PSR		
							X			X		X	X			ATSEP.QLF.SUR.PSR_1.1	Use of PSR for Air Traffic Services		
ATSEP QUALIFICATION - Streams													ATSEP UID (Unique Objective Identifier)	CORPUS	Tax	CONTENT			
COM-	COM-Data	NAV-NDR	NAV-DE	NAV-VOR	NAV-DMF	NAV-IIS	SLIP-PSR	SLIP-SSR	SLIP-ADS	DPR-DP	SMC-COM	SMC-NAV					SMC-SLR	SMC-DP	
							X			X		X	X			ATSEP.QLF.SUR.PSR_1.1.1	Describe the operational requirements of an en-route or an approach PSR	2	Range, resolution, coverage, availability
							X									ATSEP.QLF.SUR.PSR_1.1.2	Relate key parameters of PSR to system performance	4	Key parameters: PRF, signal energy, frequency diversity, antenna gain, update rate, polarisation, receiver MDS, beamwidth Performance: range, accuracy, resolution, extractor minimum target threshold, weather influence, PD, blind speed,

ATSEP QUALIFICATION - Streams														ATSEP UID (Unique Objective Identifier)	CORPUS	Tax	CONTENT	
COM-	COM-Data	NAV-NDR	NAV-DE	NAV-VOR	NAV-DMF	NAV-ILS	SLIP-DCR	SLIP-SSR	SLIP-ADS	DPR-DP	SMC-COM	SMC-NAV	SMC-SLR					SMC-DP
																		ambiguities, capacity e.g. weather channel
						X									ATSEP.QLF.SUR.PSR_1.2	Antenna (PSR)		
						X									ATSEP.QLF.SUR.PSR_1.2.1	Describe antenna types, accuracy and problems	2	Antenna beam(s), side lobes, reflector antenna, active (phased array) antenna, rotating joints, waveguide interface, pressurisation, dehumidification, polarisation, azimuth encoding, drive systems
						X									ATSEP.QLF.SUR.PSR_1.3	Transmitters		
						X									ATSEP.QLF.SUR.PSR_1.3.1	Describe the basic characteristics of a transmitter	2	Timing, coherence, modulation, pulse width, pulse compression, pulse energy, frequency diversity/agility
						X									ATSEP.QLF.SUR.PSR_1.3.2	Describe the signals at all key points	2	Supply, EHT, RF source (appropriate to type chosen), modulation, interlocks
						X									ATSEP.QLF.SUR.PSR_1.3.3	Describe a generic transmitter block diagram for both compressed and non-compressed system	2	e.g. solid state, klystron, magnetron, travelling wave tube

ATSEP QUALIFICATION - Streams													ATSEP UID (Unique Objective Identifier)	CORPUS	Tax	CONTENT		
COM-	COM-Data	NAV-NDR	NAV-DE	NAV-VOR	NAV-DMF	NAV-ILS	SLIP-DSR	SLIP-SSR	SLIP-ADS	DPR-DP	SMC-COM	SMC-NAV					SMC-SLIP	SMC-DP
							X								ATSEP.QLF.SUR.PSR_1.3.4	State possible failures and where they can occur in the transmitter system	1	e.g. solid state modules, arcing, corona discharge, component stress, control loops, isolation
ATSEP QUALIFICATION - Streams													ATSEP UID (Unique Objective Identifier)	CORPUS	Tax	CONTENT		
COM-	COM-Data	NAV-NDR	NAV-DE	NAV-VOR	NAV-DMF	NAV-ILS	SLIP-DSR	SLIP-SSR	SLIP-ADS	DPR-DP	SMC-COM	SMC-NAV					SMC-SLIP	SMC-DP
							X								ATSEP.QLF.SUR.PSR_1.3.5	State constraints and problems on the high voltage circuitry	1	e.g. corona discharge, dielectric stress, isolation, arcing, ageing, interlocks, stability (including control loop)
							X								ATSEP.QLF.SUR.PSR_1.4	Characteristics of Primary Targets		
							X								ATSEP.QLF.SUR.PSR_1.4.1	Appreciate the characteristics of targets detected by PSR	3	Backscatter, radar cross section (such as reflectivity, stealth technologies, aspect), Doppler shift, ground speed, wind turbines e.g. Swerling Case
							X								ATSEP.QLF.SUR.PSR_1.5	Receivers		
							X								ATSEP.QLF.SUR.PSR_1.5.1	Describe the basic characteristics of a receiver	2	Low noise, high dynamic range, bandwidth, detection, frequency, sensitivity, selectivity
							X								ATSEP.QLF.SUR.PSR_1.5.2	Describe the basic elements of a generic receiver	2	LNA, local oscillator, coherent oscillator, down-converter, filtering, rejection, IF, PSD, AGC, STC, beam switching

ATSEP QUALIFICATION - Streams													ATSEP UID (Unique Objective Identifier)	CORPUS	Tax	CONTENT		
COM-	COM-Data	NAV-NDR	NAV-DE	NAV-VOR	NAV-DMF	NAV-ILS	SLIR-DCR	SLIR-SSR	SLIR-ADS	DPR-DP	SMC-COM	SMC-NAV					SMC-SLIR	SMC-DP
							X								ATSEP.QLF.SUR.PSR_1.5.3	Appreciate the importance of STC	3	Saturation, RF-IF dynamic range
							X								ATSEP.QLF.SUR.PSR_1.6	Signal Processing and Plot Extraction		
							X								ATSEP.QLF.SUR.PSR_1.6.1	Describe the basic function of data processing	2	Plot extraction (range bin reports, range correlation, azimuth correlation), target reports, sliding window, weighted centre, local tracking
							X								ATSEP.QLF.SUR.PSR_1.6.2	Appreciate the basic functions of a current radar signal processor	3	A/D conversion, I/Q matching, target detection, detection criteria (fixed, adaptive), MTD and clutter maps
							X								ATSEP.QLF.SUR.PSR_1.6.3	Describe the processing techniques to improve the quality of target reports using scan-to-scan information	2	Tracking, environment mapping, adaptive feedback to extraction parameters
							X								ATSEP.QLF.SUR.PSR_1.7	Plot Combining		
ATSEP QUALIFICATION - Streams													ATSEP UID (Unique Objective Identifier)	CORPUS	Tax	CONTENT		
COM-	COM-Data	NAV-NDR	NAV-DE	NAV-VOR	NAV-DMF	NAV-ILS	SLIR-DCR	SLIR-SSR	SLIR-ADS	DPR-DP	SMC-COM	SMC-NAV					SMC-SLIR	SMC-DP
							X								ATSEP.QLF.SUR.PSR_1.7.1	Describe the basic function of plot combining	2	Secondary/primary combining, secondary/primary assigning, prime target, range and azimuth collimation

ATSEP QUALIFICATION - Streams													ATSEP UID (Unique Objective Identifier)	CORPUS	Tax	CONTENT		
COM-	COM-Data	NAV-NDR	NAV-DE	NAV-VOR	NAV-DMF	NAV-ILS	SLIP-DCR	SLIR-SSR	SLIR-ADS	DPR-DP	SMC-COM	SMC-NAV					SMC-SLR	SMC-DP
							X								ATSEP.QLF.SUR.PSR_1.7.2	Describe the basic functions of a current radar plot combiner	2	Scan-to-scan correlation, angle filtering, vehicle filtering, output format
							X								ATSEP.QLF.SUR.PSR_1.8	Characteristics of Primary Radar		
							X								ATSEP.QLF.SUR.PSR_1.8.1	Explain the basic principles of electromagnetism, propagation, signal detection, RF power generation and distribution	2	Frequency and phase, electromagnetic radiation, spectrum and bandwidth, noise, HPA, waveguide problems
							X								ATSEP.QLF.SUR.PSR_2	SURFACE MOVEMENT RADAR		
							X								ATSEP.QLF.SUR.PSR_2.1	Use of SMR for Air Traffic Services		
							X								ATSEP.QLF.SUR.PSR_2.1.1	Describe the operational requirements of SMR	2	Range, resolution, coverage, MTBF, availability
							X								ATSEP.QLF.SUR.PSR_2.1.2	Relate key parameters and necessity to achieve performances	4	Specific equations for ranging and power budget, PRF, frequency with respect to range and accuracy, PD, frequency diversity, range with respect to TX power, antenna gain, receiver MDS, update rate, beamwidth, extractor minimum target threshold, polarisation, influence to meteorology
							X								ATSEP.QLF.SUR.PSR_2.2	Radar Sensor		
							X								ATSEP.QLF.SUR.PSR_2.2.1	Explain the layout of the SMR	2	Dual system, service display

ATSEP QUALIFICATION - Streams													ATSEP UID (Unique Objective Identifier)	CORPUS	Tax	CONTENT		
COM-	COM-Data	NAV-NDR	NAV-DE	NAV-VOR	NAV-DMF	NAV-ILS	SLIP-PCR	SLIR-SSR	SLIR-ADS	DPR-DP	SMC-COM	SMC-NAV					SMC-SLR	SMC-DP
							X								ATSEP.QLF.SUR.PSR_2.2.2	Describe the basic functions of the receiver/transmitter unit	2	Hardware/function overview
							X								ATSEP.QLF.SUR.PSR_2.2.3	Describe how to operate a sensor	2	e.g. block diagram, timing relations, video path, frequency diversity, polarisation, controller structure
ATSEP QUALIFICATION - Streams													ATSEP UID (Unique Objective Identifier)	CORPUS	Tax	CONTENT		
COM-	COM-Data	NAV-NDR	NAV-DE	NAV-VOR	NAV-DMF	NAV-ILS	SLIP-PCR	SLIR-SSR	SLIR-ADS	DPR-DP	SMC-COM	SMC-NAV					SMC-SLR	SMC-DP
							X								ATSEP.QLF.SUR.PSR_2.2.4	Describe the basic functions of the antenna unit	2	e.g. hardware function overview, control/switch unit, external interface, azimuth encoding, monopulse techniques
							X								ATSEP.QLF.SUR.PSR_3	TEST AND MEASUREMENT		
							X								ATSEP.QLF.SUR.PSR_3.1	Test and Measurement		
							X								ATSEP.QLF.SUR.PSR_3.1.1	Appreciate how measurements can be made on PSR and SMR	3	e.g. spectrum analyser, vector voltmeter, oscilloscope, SWR meter, sensor analysis tools
							X	X				X	X		ATSEP.QLF.SUR.SSR	SECONDARY SURVEILLANCE RADAR (SSR)		
							X	X				X	X		ATSEP.QLF.SUR.SSR_1	SSR AND MONO-PULSE SSR (MSSR)		
							X	X				X	X		ATSEP.QLF.SUR.SSR_1.1	Use of SSR for Air Traffic Services		
							X	X				X	X		ATSEP.QLF.SUR.SSR_1.1.1	Describe the operational requirements of an en-route or an approach SSR	2	Range, coverage, resolution, performance, update rate ICAO Doc 9684

ATSEP QUALIFICATION - Streams													ATSEP UID (Unique Objective Identifier)	CORPUS	Tax	CONTENT		
COM-	COM-Data	NAV-NDR	NAV-DE	NAV-VOR	NAV-DMF	NAV-IIS	SLIP-PCR	SLIR-SSR	SLIR-ADS	DPR-DP	SMC-COM	SMC-NAV					SMC-SLIR	SMC-DP
								X							ATSEP.QLF.SUR.SSR_1.1.2	Relate key parameters of SSR to system performance	4	Key parameters: rotation rate, PRF, interlaced modes, capacity, frequencies, power budget (uplink, downlink), monopulse techniques Consequences: FRUIT, garbling, side lobes reception and transmission, transponder availability, PD, 2nd recurrence replies
								X							ATSEP.QLF.SUR.SSR_1.2	Antenna (SSR)		
								X							ATSEP.QLF.SUR.SSR_1.2.1	Describe the principles of SSR/MSSR antenna	2	Monopulse antenna techniques, coaxial connection, sum, difference and control pattern, off-boresight angle measurement, azimuth encoding, beam sharpening, side lobes
								X							ATSEP.QLF.SUR.SSR_1.3	Interrogator		
								X							ATSEP.QLF.SUR.SSR_1.3.1	Describe the characteristics of an interrogator	2	Frequency, spectrum, interrogation modes, duty cycle, ISLS, IISLS, staggering
ATSEP QUALIFICATION - Streams													ATSEP UID (Unique Objective Identifier)	CORPUS	Tax	CONTENT		
COM-	COM-Data	NAV-NDR	NAV-DE	NAV-VOR	NAV-DMF	NAV-IIS	SLIP-PCR	SLIR-SSR	SLIR-ADS	DPR-DP	SMC-COM	SMC-NAV					SMC-SLIR	SMC-DP
								X							ATSEP.QLF.SUR.SSR_1.3.2	Explain a generic interrogator	2	Timing, interface, modulator, BITE

ATSEP QUALIFICATION - Streams													ATSEP UID (Unique Objective Identifier)	CORPUS	Tax	CONTENT		
COM-	COM-Data	NAV-NDR	NAV-DE	NAV-VOR	NAV-DMF	NAV-ILS	SLIP-DCR	SLIR-SSR	SLIR-ADS	DPR-DP	SMC-COM	SMC-NAV					SMC-SLR	SMC-DP
								X							ATSEP.QLF.SUR.SSR_1.3.3	Explain the need and methods for integrity monitoring	2	Safeguards against erroneous transmission, BITE, power and temperature monitoring
								X							ATSEP.QLF.SUR.SSR_1.4	Transponder		
								X							ATSEP.QLF.SUR.SSR_1.4.1	Explain the operational use of the transponder	2	Diagram of interaction between transponder and aeroplane
								X							ATSEP.QLF.SUR.SSR_1.4.2	Define the global performances	1	Range, accuracy, fixed delay to respond
								X							ATSEP.QLF.SUR.SSR_1.4.3	Describe the basic characteristics of a transponder	2	Transceiver, aerial location, switching and polar diagram, size ACAS Mode S and ADS compatibility, maximum reply rate, ISLS compatibility
								X							ATSEP.QLF.SUR.SSR_1.4.4	Explain the advantages of the transponder	2	Longer range, more information
								X							ATSEP.QLF.SUR.SSR_1.4.5	Explain the limitations of the transponder	2	Hundreds of feet precision, 3A limited codes
								X							ATSEP.QLF.SUR.SSR_1.4.6	Describe the conformity to regulations	2	Equipage obligations, ICAO Annex 10
								X							ATSEP.QLF.SUR.SSR_1.4.7	Describe the data format of the messages received by the transponder	2	P1, P2, P3, P4, P5, P6 signals and DPSK modulation (P6)
								X							ATSEP.QLF.SUR.SSR_1.4.8	Describe the data format of the transmitted transponder messages	2	Field lengths, data bits, Gray code, unused bits, Mode S reply (preamble and data)

ATSEP QUALIFICATION - Streams													ATSEP UID (Unique Objective Identifier)	CORPUS	Tax	CONTENT		
COM-	COM-Data	NAV-NDR	NAV-DE	NAV-VOR	NAV-DMF	NAV-IIS	SLIP-DSP	SLIR-SSR	SLIR-ADS	DPR-DP	SMC-COM	SMC-NAV					SMC-SLIR	SMC-DP
								X							ATSEP.QLF.SUR.SSR_1.4.9	Describe the basic characteristics of a transmitter	2	Timing, modulation, pulse width, power output
								X							ATSEP.QLF.SUR.SSR_1.4.10	Describe the use of the transponder as a field monitor	2	-
								X							ATSEP.QLF.SUR.SSR_1.5	Receivers		
ATSEP QUALIFICATION - Streams													ATSEP UID (Unique Objective Identifier)	CORPUS	Tax	CONTENT		
COM-	COM-Data	NAV-NDR	NAV-DE	NAV-VOR	NAV-DMF	NAV-IIS	SLIP-DSP	SLIR-SSR	SLIR-ADS	DPR-DP	SMC-COM	SMC-NAV					SMC-SLIR	SMC-DP
								X							ATSEP.QLF.SUR.SSR_1.5.1	Describe the basic characteristics of an SSR receiver	2	Standard/MSSR receiver, sensibility, bandwidth, dynamic range, GTC (normal, sectorised), monopulse processor, RSLs, multi-path and interferences
								X							ATSEP.QLF.SUR.SSR_1.6	Signal Processing and Plot Extraction		
								X							ATSEP.QLF.SUR.SSR_1.6.1	Describe monopulse extraction	2	Phase and amplitude modulation, off boresight angle calculation, azimuth encoding
								X							ATSEP.QLF.SUR.SSR_1.6.2	Describe sliding window SSR extraction	2	Leading edge, trailing edge, azimuth accuracy, azimuth encoding
								X							ATSEP.QLF.SUR.SSR_1.6.3	Describe the signal processing	2	Video digitiser, pulse processor, reply decoder (bracket pair detector), synchronous reply correlator
								X							ATSEP.QLF.SUR.SSR_1.6.4	Decode a transponder message	3	Standard message with SPI set e.g.

ATSEP QUALIFICATION - Streams													ATSEP UID (Unique Objective Identifier)	CORPUS	Tax	CONTENT		
COM-	COM-Data	NAV-NDR	NAV-DE	NAV-VOR	NAV-DMF	NAV-IIS	SLIP-DCR	SLIR-SSR	SLIR-ADS	DPR-DP	SMC-COM	SMC-NAV					SMC-SLIR	SMC-DP
								X							ATSEP.QLF.SUR.SSR_1.6.5	Describe the SSR processing techniques	2	Discrete code correlation, general association, zones, categories, code swapping, general correlation Mode A code data, Mode C data, target position report
								X							ATSEP.QLF.SUR.SSR_1.6.6	Explain the reasons for surveillance processing and the key options	2	False target identification and elimination, data validation, data correction, reflection identification and processing, enhanced resolution performance
								X							ATSEP.QLF.SUR.SSR_1.7	Plot Combining		
								X							ATSEP.QLF.SUR.SSR_1.7.1	Describe the basic function of plot combining	2	Secondary/primary combining, secondary/primary assigning, prime target, range and azimuth collimation
								X							ATSEP.QLF.SUR.SSR_1.7.2	Describe the basic functions of a current radar plot combiner	2	-
								X							ATSEP.QLF.SUR.SSR_1.8	Test and Measurement		
ATSEP QUALIFICATION - Streams													ATSEP UID (Unique Objective Identifier)	CORPUS	Tax	CONTENT		
COM-	COM-Data	NAV-NDR	NAV-DE	NAV-VOR	NAV-DMF	NAV-IIS	SLIP-DCR	SLIR-SSR	SLIR-ADS	DPR-DP	SMC-COM	SMC-NAV					SMC-SLIR	SMC-DP
								X							ATSEP.QLF.SUR.SSR_1.8.1	Appreciate how measurements can be made on SSR	3	e.g. spectrum analyser, vector voltmeter, oscilloscope, SWR meter, sensor analysis tools
								X	X			X	X		ATSEP.QLF.SUR.SSR_2	MODE S		

ATSEP QUALIFICATION - Streams													ATSEP UID (Unique Objective Identifier)	CORPUS	Tax	CONTENT		
COM-	COM-Data	NAV-NDR	NAV-DE	NAV-VOR	NAV-DMF	NAV-ILS	SLIP-DCR	SLIR-SSR	SLIR-ADS	DPR-DP	SMC-COM	SMC-NAV					SMC-SLR	SMC-DP
								X		X			X	X	ATSEP.QLF.SUR.SSR_2.1	Introduction to Mode S		
								X		X			X	X	ATSEP.QLF.SUR.SSR_2.1.1	Explain the need for and benefits of Mode S	2	Classical SSR limitations, resolution, accuracy, integrity, enhanced data (e.g. 25 ft resolution aircraft ID, BDS
								X		X			X	X	ATSEP.QLF.SUR.SSR_2.1.2	Explain the working principles of Mode S	2	Mode S interrogation, Mode S reply, Mode S uplink and downlink capability, Mode S formats/protocols, ELS, EHS
								X		X			X	X	ATSEP.QLF.SUR.SSR_2.1.3	Explain the complementary use of Mode S and conventional SSR	2	Mode interlace pattern, operational use of all-call, roll-call
								X		X			X	X	ATSEP.QLF.SUR.SSR_2.1.4	Explain Mode S implementation	2	Elementary and enhanced surveillance, II and SI codes, use of BDS
								X							ATSEP.QLF.SUR.SSR_2.2	Mode S System		
								X							ATSEP.QLF.SUR.SSR_2.2.1	Describe the theory of operation of Mode S hardware and software	2	Performance of the system, theory of operation of the system, interfaces to customer equipment
								X							ATSEP.QLF.SUR.SSR_2.2.2	Describe testing possibilities for Mode S	2	e.g. SASS-C, SASS-S
								X							ATSEP.QLF.SUR.SSR_3	MULTILATERATION (MLAT)		
								X							ATSEP.QLF.SUR.SSR_3.1	MLAT in Use		
								X							ATSEP.QLF.SUR.SSR_3.1.1	Explain how pilot and controller operations are impacted by the use of an MLAT system	2	Mode A assigned at gate, coverage of MLAT
								X							ATSEP.QLF.SUR.SSR_3.1.2	Describe the ground mode of transponders	2	Aircraft interrogations, squitters, change of transponder mode

ATSEP QUALIFICATION - Streams														ATSEP UID (Unique Objective Identifier)	CORPUS	Tax	CONTENT	
COM-	COM-Data	NAV-NDR	NAV-DE	NAV-VOR	NAV-DMF	NAV-ILS	SLIP-PCR	SLIR-SSR	SLIR-ADS	DPR-DP	SMC-COM	SMC-NAV	SMC-SIR					SMC-DP
								X		X			X	X	ATSEP.QLF.SUR.SSR_3.2	MLAT Principles		
ATSEP QUALIFICATION - Streams														ATSEP UID (Unique Objective Identifier)	CORPUS	Tax	CONTENT	
COM-	COM-Data	NAV-NDR	NAV-DE	NAV-VOR	NAV-DMF	NAV-ILS	SLIP-PCR	SLIR-SSR	SLIR-ADS	DPR-DP	SMC-COM	SMC-NAV	SMC-SIR					SMC-DP
								X		X			X	X	ATSEP.QLF.SUR.SSR_3.2.1	Explain the MLAT system architecture	2	Standards, transmitters and receivers, data processing/fusion, redundancy, performance, costs, timing solutions, etc.
								X		X			X	X	ATSEP.QLF.SUR.SSR_3.2.2	Appreciate the principles of MLAT system	3	Triangulation, coverage, position calculation e.g. SCAS
								X		X			X	X	ATSEP.QLF.SUR.SSR_3.2.3	Describe how to operate the system	2	Tracking, map creation and blanking
								X		X			X	X	ATSEP.QLF.SUR.SSR_3.2.4	Describe testing possibilities for MLAT	2	e.g. SASS-C
								X							ATSEP.QLF.SUR.SSR_4	SSR ENVIRONMENT		
								X							ATSEP.QLF.SUR.SSR_4.1	SSR Environment		
								X							ATSEP.QLF.SUR.SSR_4.1.1	Explain the operational use of ACAS and implications for pilots and controllers	2	Traffic Advisories, Resolution Advisories, pilot responses and controller information
								X							ATSEP.QLF.SUR.SSR_4.1.2	Describe the users of the 1 030 MHz 1 090 MHz channels	2	Modes 1, 3, A, C and S, military, Mode S uplink and downlink capability, ACAS (TCAS), acquisition and extended squitter, PRF- FRUIT ratios, DME and other interferences
								X							ATSEP.QLF.SUR.ADS	AUTOMATIC DEPENDENT SURVEILLANCE (ADS)		

ATSEP QUALIFICATION - Streams													ATSEP UID (Unique Objective Identifier)	CORPUS	Tax	CONTENT		
COM-	COM-Data	NAV-NDR	NAV-DE	NAV-VOR	NAV-DMF	NAV-ILS	SLIR-DCR	SLIR-SSR	SLIR-ADS	DPR-DP	SMC-COM	SMC-NAV					SMC-SLIR	SMC-DP
									X						ATSEP.QLF.SUR.ADS_1	GENERAL VIEW ON ADS		
									X						ATSEP.QLF.SUR.ADS_1.1	Definition of ADS		
									X						ATSEP.QLF.SUR.ADS_1.1.1	Describe the basic characteristics of a ADS	2	Performance, integrity, latency, QoS, implementation options (e.g. ATN/FANS)
									X						ATSEP.QLF.SUR.ADS_1.1.2	List the types of navigation sensors	1	GNSS, INS, radio NAVAIDS, navigation solutions from FMS, FoM
									X						ATSEP.QLF.SUR.ADS_1.1.3	State the latest developments, implementation plans and projects	1	e.g. current and recent test and trials, ICAO status, EUROCONTROL, FAA and other authorities positions, airline and equipment manufacturer positions, ATC procedures, time scales
ATSEP QUALIFICATION - Streams													ATSEP UID (Unique Objective Identifier)	CORPUS	Tax	CONTENT		
COM-	COM-Data	NAV-NDR	NAV-DE	NAV-VOR	NAV-DMF	NAV-ILS	SLIR-DCR	SLIR-SSR	SLIR-ADS	DPR-DP	SMC-COM	SMC-NAV					SMC-SLIR	SMC-DP
									X						ATSEP.QLF.SUR.ADS_2	ADS-B		
									X						ATSEP.QLF.SUR.ADS_2.1	Introduction to ADS-B		
									X						ATSEP.QLF.SUR.ADS_2.1.1	Explain the basic principles of ADS-B	2	Autonomous operation, navigation solutions, link options, aircraft situation awareness
									X						ATSEP.QLF.SUR.ADS_2.1.2	Identify the major elements of ADS-B	3	e.g. ADS-B global chain (from the aircraft to the controller HMI), GNSS, FMS, encoding, scheduling, link
									X						ATSEP.QLF.SUR.ADS_2.2	Techniques of ADS-B		

ATSEP QUALIFICATION - Streams													ATSEP UID (Unique Objective Identifier)	CORPUS	Tax	CONTENT		
COM-	COM-Data	NAV-NDR	NAV-DE	NAV-VOR	NAV-DMF	NAV-ILS	SLIP-DSP	SLIP-SSR	SLIP-ADS	DPR-DP	SMC-COM	SMC-NAV					SMC-SLR	SMC-DP
									X						ATSEP.QLF.SUR.ADS_2.2.1	Explain the characteristics of the data links used in ADS B	2	VDL Mode 4, 1090 MHz extended squitter (1090 ES), UAT
									X						ATSEP.QLF.SUR.ADS_2.2.2	Describe the major ADS-B applications	2	e.g. ADS-B-NRA, ADS-B-RAD, ASAS
									X						ATSEP.QLF.SUR.ADS_2.3	VDL Mode 4		
									X						ATSEP.QLF.SUR.ADS_2.3.1	Describe the use of VDL Mode 4	2	High-level description
									X						ATSEP.QLF.SUR.ADS_2.4	1090 MHz Extended Squitter (1090 ES)		
									X						ATSEP.QLF.SUR.ADS_2.4.1	Describe the use of the 1090 MHz extended squitter (1090 ES)	2	High-level description
									X						ATSEP.QLF.SUR.ADS_2.4.2	Explain the principles related to signals in space	2	Modulation scheme, signal structure, key data and frequency
									X						ATSEP.QLF.SUR.ADS_2.4.3	Explain the principles related to random access technology	2	Consequences on the RF environment (1 090 MHz)
									X						ATSEP.QLF.SUR.ADS_2.4.4	Explain the relevant messages	2	Information in each field, information encoding and decoding
									X						ATSEP.QLF.SUR.ADS_2.4.5	Recognise the structure of a Mode S extended squitter signal	1	Signal timing and sequencing, data encoding
									X						ATSEP.QLF.SUR.ADS_2.4.6	Explain the interface between the BDS and the extended squitter message	2	-
									X						ATSEP.QLF.SUR.ADS_2.5	Universal Access Transceiver (UAT)		
ATSEP QUALIFICATION - Streams													ATSEP UID	CORPUS		CONTENT		

ATSEP QUALIFICATION - Streams														ATSEP UID (Unique Objective Identifier)	CORPUS	Tax	CONTENT	
COM-	COM-Data	NAV-NDR	NAV-DE	NAV-VOR	NAV-DMF	NAV-ILS	SLIP-DCR	SLIP-SSR	SLIP-ADS	DPR-DP	SMC-COM	SMC-NAV	SMC-SLR					SMC-DP
									X						ATSEP.QLF.SUR.ADS_2.5.1	State the use of the UAT	1	
									X						ATSEP.QLF.SUR.ADS_2.6	ASTERIX		
									X						ATSEP.QLF.SUR.ADS_2.6.1	Identify the data format according to the ASTERIX category 21 standard	3	Reference to ASTERIX standard Decode position, call sign, Mode S address, etc.
									X						ATSEP.QLF.SUR.ADS_3	ADS-C		
									X						ATSEP.QLF.SUR.ADS_3.1	Introduction to ADS-C		
									X						ATSEP.QLF.SUR.ADS_3.1.1	Explain the basic principles of ADS-C	2	Contract, multi-contract, time, event triggering
									X						ATSEP.QLF.SUR.ADS_3.1.2	Identify the major elements of the ADS-C system	3	ADS-C global chain (from the aircraft to the controller HMI), GNSS, processor, link, ground station
									X						ATSEP.QLF.SUR.ADS_3.2	Techniques in ADS-C		
									X						ATSEP.QLF.SUR.ADS_3.2.1	Explain the characteristics of the data links used in ADS-C	2	e.g. subnetworks (VDLs, AMSS, HFDL)
							X	X	X	X		X	X	ATSEP.QLF.SUR.HMI	HUMAN MACHINE INTERFACE (HMI)			
							X	X	X	X		X	X	ATSEP.QLF.SUR.HMI_1	HMI			
							X	X	X	X		X	X	ATSEP.QLF.SUR.HMI_1.1	ATCO HMI			
							X	X	X	X		X	X	ATSEP.QLF.SUR.HMI_1.1.1	Describe the display types available	2	Video, synthetic, mixed	
							X	X	X	X		X	X	ATSEP.QLF.SUR.HMI_1.1.2	State the type of selections available	1	Source, range, maps, filters	

ATSEP QUALIFICATION - Streams														ATSEP UID (Unique Objective Identifier)	CORPUS	Tax	CONTENT	
COM-	COM-Data	NAV-NDR	NAV-DE	NAV-VOR	NAV-DMF	NAV-IIS	SLIP-DCR	SLIR-SSR	SLIR-ADS	DPR-DP	SMC-COM	SMC-NAV	SMC-SLIR					SMC-DP
							X	X	X	X			X	X	ATSEP.QLF.SUR.HMI_1.1.3	Describe the advantages of different display types	2	Clarity, configurability, fallback, data integration
							X	X	X						ATSEP.QLF.SUR.HMI_1.2	ATSEP HMI		
							X	X	X						ATSEP.QLF.SUR.HMI_1.2.1	Describe the user interface scope and ergonomics as seen by different users and at different locations	2	System management displays characteristics both control and monitoring
							X	X	X						ATSEP.QLF.SUR.HMI_1.2.2	Describe the analytical and status data available to the users	2	Radar video, front panel and CMS data, HMI on each subsystem
							X	X	X						ATSEP.QLF.SUR.HMI_1.3	Pilot HMI		
							X	X	X						ATSEP.QLF.SUR.HMI_1.3.1	Describe the transponder interface	2	Mode A, change procedure, SPI, Mode C, deselection, hijack
ATSEP QUALIFICATION - Streams														ATSEP UID (Unique Objective Identifier)	CORPUS	Tax	CONTENT	
COM-	COM-Data	NAV-NDR	NAV-DE	NAV-VOR	NAV-DMF	NAV-IIS	SLIP-DCR	SLIR-SSR	SLIR-ADS	DPR-DP	SMC-COM	SMC-NAV	SMC-SLIR					SMC-DP
							X	X	X						ATSEP.QLF.SUR.HMI_1.3.2	Recognise the ACAS/TCAS display and future potential developments	1	Characteristics, accuracy, alerts, ADS B, CDTI
							X	X	X						ATSEP.QLF.SUR.HMI_1.3.3	Recognise the EGPWS display and of future potential developments	1	-
							X	X	X						ATSEP.QLF.SUR.HMI_1.4	Displays		

ATSEP QUALIFICATION - Streams													ATSEP UID (Unique Objective Identifier)	CORPUS	Tax	CONTENT		
COM-	COM-Data	NAV-NDR	NAV-DE	NAV-VOR	NAV-DMF	NAV-ILS	SLIP-DCR	SLIP-SSR	SLIP-ADS	DPR-DP	SMC-COM	SMC-NAV					SMC-SLR	SMC-DP
							X	X	X						ATSEP.QLF.SUR.HMI_1.4.1	Describe the display types available and their advantages and disadvantages	2	Raster/rotating, raw/synthetic, monochrome/colour, CRT/LCD, performances (cost, availability, maintainability, ergonomics)
							X	X	X	X			X	X	ATSEP.QLF.SUR.SDT	SURVEILLANCE TRANSMISSION	DATA	
							X	X	X	X			X	X	ATSEP.QLF.SUR.SDT_1	SURVEILLANCE TRANSMISSION	DATA	
							X	X	X	X			X	X	ATSEP.QLF.SUR.SDT_1.1	Technology and Protocols		
							X	X	X	X			X	X	ATSEP.QLF.SUR.SDT_1.1.1	Describe the implementation of formats and protocols	2	Network protocols, Surveillance Data Networks (e.g. RADNET), messages CAT 1+
							X	X	X	X			X	X	ATSEP.QLF.SUR.SDT_1.1.2	Decode ASTERIX messages	3	e.g. categories 1, 2, 20, 21, 34, 48, 62
							X	X	X	X			X	X	ATSEP.QLF.SUR.SDT_1.1.3	Identify the data transmission architecture in a multisensor environment	3	Fault tolerance, redundancy of line equipment e.g. software fallback capability, contingency of service, RADNET
							X	X	X	X			X	X	ATSEP.QLF.SUR.SDT_1.1.4	Characterise the degradations of the surveillance transmission network	2	e.g. saturation, excess latency
							X	X	X						ATSEP.QLF.SUR.SDT_1.2	Verification Methods		
							X	X	X						ATSEP.QLF.SUR.SDT_1.2.1	Identify the causes of a fault, based on test tool measurements	3	e.g. data analyser, line analyser
										X				X	ATSEP.QLF.DPR	ATSEP QUALIFICATION DOMAIN - DATA PROCESSING		
										X					ATSEP.QLF.DPR.FST	FUNCTIONAL SAFETY		

ATSEP QUALIFICATION - Streams													ATSEP UID (Unique Objective Identifier)	CORPUS	Tax	CONTENT		
COM-	COM-Data	NAV-NDR	NAV-DE	NAV-VOR	NAV-DMF	NAV-IIS	SLIP-DSP	SLIP-SSR	SLIP-ADS	DPR-DP	SMC-COM	SMC-NAV					SMC-SLIP	SMC-DP
										X					ATSEP.QLF.DPR.FST_1	FUNCTIONAL SAFETY		
										X					ATSEP.QLF.DPR.FST_1.1	Software Integrity and Security		
ATSEP QUALIFICATION - Streams													ATSEP UID (Unique Objective Identifier)	CORPUS	Tax	CONTENT		
COM-	COM-Data	NAV-NDR	NAV-DE	NAV-VOR	NAV-DMF	NAV-IIS	SLIP-DSP	SLIP-SSR	SLIP-ADS	DPR-DP	SMC-COM	SMC-NAV					SMC-SLIP	SMC-DP
										X					ATSEP.QLF.DPR.FST_1.1.1	Appreciate how a system can be defended against potential hostile intent via the data processing systems/internet	3	Input verification, secure sources e.g. leased lines, private networks, eligibility, firewall protection, user/password management, VPN connection
										X					ATSEP.QLF.DPR.FST_1.1.2	Explain how the normal input of a system could be used by non-authorised persons with hostile intent	2	e.g. obstruction of radar/sensor communication and location (Mode S, ADS-B, etc.)
										X					ATSEP.QLF.DPR.FST_1.1.3	Estimate the impact of security and integrity failure to the operational service	3	e.g. system crashes due to incorrect input data, main and standby and fallback systems all have same input, possible loss in total of system, results in capacity reductions and safety consequences
										X					ATSEP.QLF.DPR.FST_1.1.4	Appreciate error detection and handling in data, hardware and process	3	Identification, consequence, scope, reporting, fault tolerance, soft fail, failsafe, monitoring, fallback
										X				X	ATSEP.QLF.DPR.DPS	DATA PROCESSING SYSTEMS		
										X				X	ATSEP.QLF.DPR.DPS_1	USER REQUIREMENTS		

ATSEP QUALIFICATION - Streams														ATSEP UID (Unique Objective Identifier)	CORPUS	Tax	CONTENT	
COM-	COM-Data	NAV-NDR	NAV-DE	NAV-VOR	NAV-DMF	NAV-ILS	SIIR-DCR	SIIR-SSR	SIIR-ADS	DPR-DP	SMC-COM	SMC-NAV	SMC-SIIR					SMC-DP
										X				X	ATSEP.QLF.DPR.DPS_1.1	Controller Requirements		
										X				X	ATSEP.QLF.DPR.DPS_1.1.1	Explain ATCO missions and services needed in an area control centre	2	Operational requirements e.g. separation, flight progress monitoring and coordination, trajectory prediction, coordination with adjacent centres
										X				X	ATSEP.QLF.DPR.DPS_1.1.2	Explain ATCO missions and services needed in an approach control unit	2	Operational requirements e.g. vectoring, sequencing, AMAN, CDM
										X				X	ATSEP.QLF.DPR.DPS_1.1.3	Explain ATCO missions and services needed in an aerodrome control tower	2	Operational requirements e.g. runway management, DMAN
										X				X	ATSEP.QLF.DPR.DPS_1.2	Trajectories, Prediction and Calculation		
ATSEP QUALIFICATION - Streams														ATSEP UID (Unique Objective Identifier)	CORPUS	Tax	CONTENT	
COM-	COM-Data	NAV-NDR	NAV-DE	NAV-VOR	NAV-DMF	NAV-ILS	SIIR-DCR	SIIR-SSR	SIIR-ADS	DPR-DP	SMC-COM	SMC-NAV	SMC-SIIR					SMC-DP
										X				X	ATSEP.QLF.DPR.DPS_1.2.1	State different types of trajectories	1	e.g. FPL-based, surveillance data-based, FMS-based
										X				X	ATSEP.QLF.DPR.DPS_1.2.2	Explain the main processes for trajectory prediction	2	SDP trajectory, FPL trajectory, merged trajectory, predicted trajectory
										X				X	ATSEP.QLF.DPR.DPS_1.3	Ground Safety Nets		
										X				X	ATSEP.QLF.DPR.DPS_1.3.1	Describe the function of safety nets and their legal status	2	STCA, APW, MSAW, ASMGCS-based safety

ATSEP QUALIFICATION - Streams														ATSEP UID (Unique Objective Identifier)	CORPUS	Tax	CONTENT	
COM-	COM-Data	NAV-NDR	NAV-DE	NAV-VOR	NAV-DMF	NAV-ILS	SLIP-DCR	SLIP-SSR	SLIP-ADS	DPR-DP	SMC-COM	SMC-NAV	SMC-SLR					SMC-DP
																		nets
										X				X	ATSEP.QLF.DPR.DPS_1.4	Decision Support		
										X				X	ATSEP.QLF.DPR.DPS_1.4.1	Explain the major steps in the air traffic planning process	2	ATFCM with strategic, pre-tactical and tactical, ATC sector planning, tactical control
										X				X	ATSEP.QLF.DPR.DPS_1.4.2	Explain the principles of trajectory prediction, conformance monitoring and medium term conflict detection processes	2	Route adherence monitoring e.g. CORA, MTCO, CLAM, Level adherence monitoring
										X				X	ATSEP.QLF.DPR.DPS_1.4.3	Explain the benefit of these tools for safety and efficiency	2	-
										X					ATSEP.QLF.DPR.DPS_2	SYSTEM COMPONENTS		
										X					ATSEP.QLF.DPR.DPS_2.1	Processing Systems		
										X					ATSEP.QLF.DPR.DPS_2.1.1	Describe all major components of a data processing system	2	Functional architecture, technical architecture, supervision
										X					ATSEP.QLF.DPR.DPS_2.2	Flight Data Processing Systems		
										X					ATSEP.QLF.DPR.DPS_2.2.1	Identify all functions of an FDP system	3	FDPS reference model, message handling, initial flight data handling, relationship with other functions, air-ground data link processing, trajectory prediction, flight data management and distribution, SSR Mode A code assignment and management, correlation, coordination and transfer, Mode S

ATSEP QUALIFICATION - Streams														ATSEP UID (Unique Objective Identifier)	CORPUS	Tax	CONTENT	
COM-	COM-Data	NAV-NDR	NAV-DE	NAV-VOR	NAV-DMF	NAV-ILS	SLIP-DSP	SLIP-SSR	SLIP-ADS	DPR-DP	SMC-COM	SMC-NAV	SMC-SLIP					SMC-DP
										X					ATSEP.QLF.DPR.DPS_2.2.2	Describe all major components of an FDP	2	Functional architecture, technical architecture e.g. HMI, ATC tools, support tools (technical supervision, QoS monitors and logging)
										X					ATSEP.QLF.DPR.DPS_2.2.3	Differentiate FDP features in the ATS units	2	Area control centres Approach control units Aerodrome control towers
										X					ATSEP.QLF.DPR.DPS_2.2.4	Explain how to operate the system	2	e.g. configuration, adjust parameters, start up and shut down, monitoring
										X					ATSEP.QLF.DPR.DPS_2.2.5	Explain the principles of emergency switching	2	System degradation e.g. automatic versus manual cluster takeover, need to notify ATCO's supervisor, operational consequences
							X	X	X	X					ATSEP.QLF.DPR.DPS_2.3	Surveillance Data Processing Systems		
							X	X	X	X					ATSEP.QLF.DPR.DPS_2.3.1	Identify all functions of an SDP system	3	Plot processing, tracking, single sensor and multisensor tracker (e.g. radar, ADS, MLAT), estimating limits and accuracy of multisensor tracker, recording e.g. ARTAS tracker

ATSEP QUALIFICATION - Streams														ATSEP UID (Unique Objective Identifier)	CORPUS	Tax	CONTENT	
COM-	COM-Data	NAV-NDR	NAV-DE	NAV-VOR	NAV-DMF	NAV-ILS	SLIP-DCR	SLIR-SSR	SLIR-ADS	DPR-DP	SMC-COM	SMC-NAV	SMC-SLIR					SMC-DP
							X	X	X	X					ATSEP.QLF.DPR.DPS_2.3.2	Describe all major components of an SDP	2	Functional architecture, technical architecture
							X	X	X	X					ATSEP.QLF.DPR.DPS_2.3.3	Differentiate SDP features in the ATS units	2	Area control centres Approach control units Aerodrome control towers
							X	X	X	X					ATSEP.QLF.DPR.DPS_2.3.4	Appreciate how to operate the system	3	e.g. configuration, adjust parameters, start up and shut down, monitoring
							X	X	X	X					ATSEP.QLF.DPR.DPS_2.3.5	Explain the principles of emergency switching	2	-
X											X	X		X	ATSEP.QLF.DPR.PRC	DATA PROCESS		
X											X	X		X	ATSEP.QLF.DPR.PRC_1	SOFTWARE PROCESS		
										X					ATSEP.QLF.DPR.PRC_1.1	Middleware		
ATSEP QUALIFICATION - Streams														ATSEP UID (Unique Objective Identifier)	CORPUS	Tax	CONTENT	
COM-	COM-Data	NAV-NDR	NAV-DE	NAV-VOR	NAV-DMF	NAV-ILS	SLIP-DCR	SLIR-SSR	SLIR-ADS	DPR-DP	SMC-COM	SMC-NAV	SMC-SLIR					SMC-DP
										X					ATSEP.QLF.DPR.PRC_1.1.1	Characterise middleware	2	Additional specialised functional built on the OS
										X					ATSEP.QLF.DPR.PRC_1.1.2	List the middleware used on the national major systems	1	e.g. CORBA, UBSS, OTM, EJB
										X					ATSEP.QLF.DPR.PRC_1.1.3	Describe the use of a middleware in an ATM environment	2	Dual processing system
X										X	X			X	ATSEP.QLF.DPR.PRC_1.2	Operating Systems		

ATSEP QUALIFICATION - Streams													ATSEP UID (Unique Objective Identifier)	CORPUS	Tax	CONTENT		
COM-	COM-Data	NAV-NDR	NAV-DE	NAV-VOR	NAV-DMF	NAV-ILS	SLIP-DCR	SLIR-SSR	SLIR-ADS	DPR-DP	SMC-COM	SMC-NAV					SMC-SLR	SMC-DP
										X					ATSEP.QLF.DPR.PRC_1.2.1	Describe the major aspects of a relevant operating system	2	e.g. design, start-up, configuration, back-up and restore
	X									X	X			X	ATSEP.QLF.DPR.PRC_1.2.2	Identify relevant operating system commands	3	e.g. LINUX systems
										X					ATSEP.QLF.DPR.PRC_1.2.3	Characterise typical consequences of an OS upgrade	2	Some possible implications on HW (performance, memory), middleware (compatibility) and SW components
										X					ATSEP.QLF.DPR.PRC_1.2.4	Explain downward compatibility	2	Checks on embedded SW modules ability to run under new OS version
										X					ATSEP.QLF.DPR.PRC_1.2.5	Take account of hardware/software compatibility	2	Examples of HW requirements of specific SW implementations
										X					ATSEP.QLF.DPR.PRC_1.2.6	Describe interactions between application and OS	2	Examples of OS calls by the application software if no middleware is in use
										X					ATSEP.QLF.DPR.PRC_1.2.7	Describe the life cycle management of an operating system	2	e.g. versions, releases, patches, migration
										X					ATSEP.QLF.DPR.PRC_1.2.8	Appreciate different installation methods	3	e.g. RIS server, install server, PXE boot - services, configuration
										X					ATSEP.QLF.DPR.PRC_1.2.9	Differentiate operating systems and their potential application areas	2	Standard (COTS) edition vs. customised edition OS, consideration of security, upgradeability and compatibility
										X					ATSEP.QLF.DPR.PRC_1.3	Configuration Control		

ATSEP QUALIFICATION - Streams													ATSEP UID (Unique Objective Identifier)	CORPUS	Tax	CONTENT		
COM-	COM-Data	NAV-NDR	NAV-DE	NAV-VOR	NAV-DMF	NAV-ILS	SLIP-DSP	SLIR-SSR	SLIR-ADS	DPR-DP	SMC-COM	SMC-NAV					SMC-SLIR	SMC-DP
										X					ATSEP.QLF.DPR.PRC_1.3.1	Describe the principles of configuration control	2	Clear identification of all versions, proof of testing and 'build state', tool and mechanisms to aid control, authorisation, audit trail, appropriate quality standard requirements of the administration
										X					ATSEP.QLF.DPR.PRC_1.4	Software Development Process		
										X					ATSEP.QLF.DPR.PRC_1.4.1	State the main software development processes	1	SWALs e.g. life cycle, waterfall model, RUP
										X					ATSEP.QLF.DPR.PRC_1.4.2	List the main steps of two of the main software development processes	1	-
										X					ATSEP.QLF.DPR.PRC_1.4.3	Explain the main differences between two software development processes	2	e.g. advantages/disadvantages
										X			X		ATSEP.QLF.DPR.PRC_2	HARDWARE PLATFORM		
										X			X		ATSEP.QLF.DPR.PRC_2.1	Equipment Upgrade		

ATSEP QUALIFICATION - Streams														ATSEP UID (Unique Objective Identifier)	CORPUS	Tax	CONTENT	
COM-	COM-Data	NAV-NDR	NAV-DE	NAV-VOR	NAV-DMF	NAV-ILS	SLIP-DCR	SLIP-SSR	SLIP-ADS	DPR-DP	SMC-COM	SMC-NAV	SMC-SLIP					SMC-DP
										X				X	ATSEP.QLF.DPR.PRC_2.1.1	Explain the key factors that have to be considered when data processing equipment is upgraded or changed	2	Specification, compatibility, 'proven' or 'state-of-the-art' technology, maintenance and operating consequence (e.g. personnel, training, spares, procedures), environmental requirements (e.g. size, power requirements, temperature, interfaces), testing
										X				X	ATSEP.QLF.DPR.PRC_2.2	Commercial Off-The-Shelf (COTS)		
										X				X	ATSEP.QLF.DPR.PRC_2.2.1	Explain the advantages and disadvantages of commercial off-the-shelf equipment	2	Cost, multiplicity of suppliers, quality, maintainability, life cycle, liability
										X				X	ATSEP.QLF.DPR.PRC_2.3	Interdependence		
										X				X	ATSEP.QLF.DPR.PRC_2.3.1	Describe the technical issues regarding the interdependence of various equipment and systems	2	Interface requirements, common point of failure, data conditioning, response time
ATSEP QUALIFICATION - Streams														ATSEP UID (Unique Objective Identifier)	CORPUS	Tax	CONTENT	
COM-	COM-Data	NAV-NDR	NAV-DE	NAV-VOR	NAV-DMF	NAV-ILS	SLIP-DCR	SLIP-SSR	SLIP-ADS	DPR-DP	SMC-COM	SMC-NAV	SMC-SLIP					SMC-DP
										X					ATSEP.QLF.DPR.PRC_2.3.2	Describe techniques for virtualisation	2	Hypervisor e.g. Hypervisor Type-1, Hypervisor Type-2, container technology (LXC, Docker)
										X					ATSEP.QLF.DPR.PRC_2.4	Maintainability		

ATSEP QUALIFICATION - Streams													ATSEP UID (Unique Objective Identifier)	CORPUS	Tax	CONTENT		
COM-	COM-Data	NAV-NDR	NAV-DE	NAV-VOR	NAV-DMF	NAV-ILS	SLIP-DCR	SLIP-SSR	SLIP-ADS	DPR-DP	SMC-COM	SMC-NAV					SMC-SLIP	SMC-DP
										X					ATSEP.QLF.DPR.PRC_2.4.1	Identify the issues that will affect the maintainability of hardware for the planned life of a system	3	Commercial product life, commercial support commitments, company volatility, spares provision, shelf life and logistics
										X					ATSEP.QLF.DPR.PRC_3	TESTING		
										X					ATSEP.QLF.DPR.PRC_3.1	Testing		
										X					ATSEP.QLF.DPR.PRC_3.1.1	Appreciate the techniques available for system and performance requirements testing	3	e.g. code walkthrough, modelling, simulation real time and fast time, black box testing, formal methods, use of independent test personnel, data corruption simulation, hardware failure simulation
										X					ATSEP.QLF.DPR.PRC_3.1.2	Appreciate the techniques available for system testing and integration	3	e.g. system integration testing, load testing, regression testing
										X					ATSEP.QLF.DPR.PRC_4	VIRTUALISATION		
										X					ATSEP.QLF.DPR.PRC_4.1	Introduction to Virtualisation		
										X					ATSEP.QLF.DPR.PRC_4.1.1	Explain the concept of virtualisation	2	the working principles, advantages and disadvantages
										X					ATSEP.QLF.DPR.PRC_4.1.2	Describe the virtualisation technologies and tools in use	2	e.g. VMWare, Hypervisor
										X					ATSEP.QLF.DPR.PRC_4.1.3	Consider how virtualisation can be used in ATM environment	2	
										X		X			ATSEP.QLF.DPR.DTA	DATA		
										X		X			ATSEP.QLF.DPR.DTA_1	DATA ESSENTIALS FEATURES		
										X		X			ATSEP.QLF.DPR.DTA_1.1	Data Significance		

ATSEP QUALIFICATION - Streams														ATSEP UID (Unique Objective Identifier)	CORPUS	Tax	CONTENT	
COM-	COM-Data	NAV-NDR	NAV-DE	NAV-VOR	NAV-DMF	NAV-ILS	SLIP-DSP	SLIP-SSR	SLIP-ADS	DPR-DP	SMC-COM	SMC-NAV	SMC-SLIP					SMC-DP
										X				X	ATSEP.QLF.DPR.DTA_1.1.1	Explain the significance of data	2	Criticality (critical/non critical), legality (ICAO, CAA, organisation), use (advisory, control)
										X				X	ATSEP.QLF.DPR.DTA_1.2	Data Configuration Control		
										X				X	ATSEP.QLF.DPR.DTA_1.2.1	Explain the control procedures for changes to operational data	2	Designated roles/persons for authorising changes and verifying/checking changes
										X				X	ATSEP.QLF.DPR.DTA_1.3	Data Standards		
										X				X	ATSEP.QLF.DPR.DTA_1.3.1	Name the authority responsible for standards	1	e.g. EUROCONTROL, ICAO, ISO
										X				X	ATSEP.QLF.DPR.DTA_1.3.2	State the standards related to ATM data, their sources and their status	1	e.g. ASTERIX, WGS84, OLDI, FMTP, AMHS, ADEX-P, FPL
										X				X	ATSEP.QLF.DPR.DTA_1.3.3	Decode a typical OLDI message	3	e.g. ACT, PAC
										X				X	ATSEP.QLF.DPR.DTA_1.3.4	State the nature of ATM processing requirements	1	Data volatility (e.g. radar), system integrity, consequence of failure
										X					ATSEP.QLF.DPR.DTA_2	ATM DATA DETAILED STRUCTURE		
										X					ATSEP.QLF.DPR.DTA_2.1	System Area		
										X					ATSEP.QLF.DPR.DTA_2.1.1	Describe how a system area is defined	2	e.g. size, system centre (reference point)

ATSEP QUALIFICATION - Streams													ATSEP UID (Unique Objective Identifier)	CORPUS	Tax	CONTENT		
COM-	COM-Data	NAV-NDR	NAV-DE	NAV-VOR	NAV-DMF	NAV-ILS	SLIP-DSP	SLIR-SSR	SLIR-ADS	DPR-DP	SMC-COM	SMC-NAV					SMC-SLIR	SMC-DP
										X					ATSEP.QLF.DPR.DTA_2.1.2	Describe the data related to the system area	2	e.g. radar data, flight plan data, maps, coordinates
										X					ATSEP.QLF.DPR.DTA_2.2	Characteristic Points		
										X					ATSEP.QLF.DPR.DTA_2.2.1	State types of characteristic points used in an ATM system and their structure	1	Geographic, routing, sector e.g. Geographic: airports and runways, ILS, radar, limit points Routing and sectors: coded routes, SID allocation parameters, area navigation waypoints, adjacent FIRs, holding, sectors
										X					ATSEP.QLF.DPR.DTA_2.2.2	Explain the importance of characteristic points in the correct presentation of data	2	-
ATSEP QUALIFICATION - Streams													ATSEP UID (Unique Objective Identifier)	CORPUS	Tax	CONTENT		
COM-	COM-Data	NAV-NDR	NAV-DE	NAV-VOR	NAV-DMF	NAV-ILS	SLIP-DSP	SLIR-SSR	SLIR-ADS	DPR-DP	SMC-COM	SMC-NAV					SMC-SLIR	SMC-DP
										X					ATSEP.QLF.DPR.DTA_2.2.3	Describe the process by which amended adaptation files are introduced	2	-
										X					ATSEP.QLF.DPR.DTA_2.3	Aircraft Performance		
										X					ATSEP.QLF.DPR.DTA_2.3.1	List the performance data used in FDPS	1	Example of data from in-house system
										X					ATSEP.QLF.DPR.DTA_2.3.2	Describe the structure of aircraft performance data	2	-
										X					ATSEP.QLF.DPR.DTA_2.3.3	Define speeds, rates and levels	1	-

ATSEP QUALIFICATION - Streams														ATSEP UID (Unique Objective Identifier)	CORPUS	Tax	CONTENT	
COM-	COM-Data	NAV-NDR	NAV-DE	NAV-VOR	NAV-DMF	NAV-ILS	SLIP-DCR	SLIP-SSR	SLIP-ADS	DPR-DP	SMC-COM	SMC-NAV	SMC-SLR					SMC-DP
										X					ATSEP.QLF.DPR.DTA_2.3.4	Explain the consequences of the use of the wrong type of aircraft	2	-
										X					ATSEP.QLF.DPR.DTA_2.4	Screen Manager		
										X					ATSEP.QLF.DPR.DTA_2.4.1	Describe how the screen manager is used to set up the ATC HMI	2	-
										X					ATSEP.QLF.DPR.DTA_2.5	Auto-coordination Messages		
										X					ATSEP.QLF.DPR.DTA_2.5.1	Describe the meaning of coordination messages in the control process	2	Coordination parameters, conditions groups, OLDI conditions groups, characteristics of remote centres
										X					ATSEP.QLF.DPR.DTA_2.5.2	Describe the characteristics of the remote centres relevant to OLDI	2	Civil and military
										X					ATSEP.QLF.DPR.DTA_2.6	Configuration Control Data		
										X					ATSEP.QLF.DPR.DTA_2.6.1	Explain the structure of the configuration data	2	Sector CSU link, sectorisation plan, control parameters
										X					ATSEP.QLF.DPR.DTA_2.7	Physical Configuration Data		
										X					ATSEP.QLF.DPR.DTA_2.7.1	Explain the structure of the physical configuration data	2	External configuration, device configuration
										X					ATSEP.QLF.DPR.DTA_2.8	Relevant Meteorology Data		
										X					ATSEP.QLF.DPR.DTA_2.8.1	Explain the organisation of the data related to meteorology	2	Meteorology, QNH TL areas, CB activity
										X					ATSEP.QLF.DPR.DTA_2.9	Alert and Error Messages to ATSEP		
ATSEP QUALIFICATION - Streams														ATSEP UID	CORPUS		CONTENT	

ATSEP QUALIFICATION - Streams														ATSEP UID (Unique Objective Identifier)	CORPUS	Tax	CONTENT	
COM-	COM-Data	NAV-NDR	NAV-DE	NAV-VOR	NAV-DMF	NAV-IIS	SIIR-DCR	SIIR-SSR	SIIR-ADS	DPR-DP	SMC-COM	SMC-NAV	SMC-SIIR					SMC-DP
											X	X	X	X	ATSEP.QLF.SMC.ANS_1.1.2	Describe the structure, roles and responsibilities of the SMC team and any direct interfaces	2	-
											X	X	X	X	ATSEP.QLF.SMC.ANS_1.1.3	Explain the duties of the ATC supervisor	2	-
											X	X	X	X	ATSEP.QLF.SMC.ANS_2	ANSP MAINTENANCE PROGRAM		
											X	X	X	X	ATSEP.QLF.SMC.ANS_2.1	Policy		
											X	X	X	X	ATSEP.QLF.SMC.ANS_2.1.1	Describe, in general terms, the ANSP maintenance policy	2	-
											X	X	X	X	ATSEP.QLF.SMC.ANS_2.1.2	Describe the aspects of the maintenance policy that apply specifically to SMC	2	-
ATSEP QUALIFICATION - Streams														ATSEP UID (Unique Objective Identifier)	CORPUS	Tax	CONTENT	
COM-	COM-Data	NAV-NDR	NAV-DE	NAV-VOR	NAV-DMF	NAV-IIS	SIIR-DCR	SIIR-SSR	SIIR-ADS	DPR-DP	SMC-COM	SMC-NAV	SMC-SIIR					SMC-DP
											X	X	X	X	ATSEP.QLF.SMC.ANS_3	ATM CONTEXT		
											X	X	X	X	ATSEP.QLF.SMC.ANS_3.1	ATM Context		
											X	X	X	X	ATSEP.QLF.SMC.ANS_3.1.1	Describe the ATM requirements and the related services provided by the SMC	2	Service level agreements, working arrangements e.g. ASM, ATFCM
											X	X	X	X	ATSEP.QLF.SMC.ANS_4	ANSP ADMINISTRATIVE PRACTICES		
											X	X	X	X	ATSEP.QLF.SMC.ANS_4.1	Administration		

ATSEP QUALIFICATION - Streams													ATSEP UID (Unique Objective Identifier)	CORPUS	Tax	CONTENT		
COM-	COM-Data	NAV-NDR	NAV-DE	NAV-VOR	NAV-DMF	NAV-ILS	SLIP-DCR	SLIP-SSR	SLIP-ADS	DPR-DP	SMC-COM	SMC-NAV					SMC-SLR	SMC-DP
											X	X	X	X	ATSEP.QLF.SMC.ANS_4.1.1	Describe any ANSP administrative procedures, specifically applicable to SMC	2	Any non-technical practices e.g. security, access control (building and platform), safety, fire
											X	X	X	X	ATSEP.QLF.SMC.ASE	ANS SYSTEM/EQUIPMENT		
											X	X	X	X	ATSEP.QLF.SMC.ASE_1	OPERATIONAL IMPACTS		
											X	X	X	X	ATSEP.QLF.SMC.ASE_1.1	Degradation or Loss of System/Equipment Services		
											X	X	X	X	ATSEP.QLF.SMC.ASE_1.1.1	Describe the importance of monitoring system performance	2	-
											X	X	X	X	ATSEP.QLF.SMC.ASE_1.1.2	Describe possible ways in which the SMC may become aware of degradation of services and/or systems	2	e.g. monitoring systems, telephone calls, aural alerts, user complaint
											X	X	X	X	ATSEP.QLF.SMC.ASE_1.1.3	Take account of the end users/customers affected	2	e.g. ATC Units, airports, airlines
											X	X	X	X	ATSEP.QLF.SMC.ASE_1.1.4	Appreciate the implications for end users/customers	3	-
											X	X	X	X	ATSEP.QLF.SMC.ASE_1.1.5	Appreciate the appropriate actions to restore service	3	e.g. switching, replacing, reconfiguration, calling external service provider
											X	X	X	X	ATSEP.QLF.SMC.ASE_1.1.6	Appreciate the need for appropriate communication before and after restoring service	3	e.g. users, customers, external and internal providers
											X	X	X	X	ATSEP.QLF.SMC.ASE_2	USER POSITION FUNCTIONALITY AND OPERATION		
											X	X	X	X	ATSEP.QLF.SMC.ASE_2.1	User Working Position		
ATSEP QUALIFICATION - Streams													ATSEP UID	CORPUS		CONTENT		

ATSEP QUALIFICATION - Streams													ATSEP UID (Unique Objective Identifier)	CORPUS	Tax	CONTENT		
COM-	COM-Data	NAV-NDR	NAV-DE	NAV-VOR	NAV-DMF	NAV-ILS	SIIP-DCR	SIIP-SSR	SIIP-ADS	DPR-DP	SMC-COM	SMC-NAV					SMC-SIIP	SMC-DP
											X	X	X	X	ATSEP.QLF.SMC.ASE_2.1.1	Appreciate working position performance to agreed parameters	3	e.g. ATCO, MET, ATSEP, airport positions
											X	X	X	X	ATSEP.QLF.SMC.ASE_2.2	SMC Working Position		
											X	X	X	X	ATSEP.QLF.SMC.ASE_2.2.1	Appreciate SMC working position performance to agreed parameters	3	-
											X	X	X	X	ATSEP.QLF.SMC.TPP	TOOLS, PROCESSES AND PROCEDURES		
											X	X	X	X	ATSEP.QLF.SMC.TPP_1	REQUIREMENTS		
											X	X	X	X	ATSEP.QLF.SMC.TPP_1.1	Safety Management System (SMS)		
											X	X	X	X	ATSEP.QLF.SMC.TPP_1.1.1	Describe the ICAO and European requirements and the national and ATSP SMS	2	ICAO Annex 19, Annex IV to Regulation (EU) 2017/373
											X	X	X	X	ATSEP.QLF.SMC.TPP_1.2	Quality Management System (QMS)		
											X	X	X	X	ATSEP.QLF.SMC.TPP_1.2.1	Describe the quality management system requirements	2	e.g. ISO, EFQM
											X	X	X	X	ATSEP.QLF.SMC.TPP_1.3	SMS Application in the Working Environment		
											X	X	X	X	ATSEP.QLF.SMC.TPP_1.3.1	Describe the relationship between the SMS and the application of SMC	2	Reporting procedures

ATSEP QUALIFICATION - Streams														ATSEP UID (Unique Objective Identifier)	CORPUS	Tax	CONTENT	
COM-	COM-Data	NAV-NDR	NAV-DE	NAV-VOR	NAV-DMF	NAV-IIS	SIIP-DCR	SIIP-SSR	SIIP-ADS	DPR-DP	SMC-COM	SMC-NAV	SMC-SIIP					SMC-DP
											X	X	X	X	ATSEP.QLF.SMC.TPP_1.3.2	Explain which occurrences require incident reporting and follow-up action(s)	2	e.g. national categories for reporting, safety event processing
											X	X	X	X	ATSEP.QLF.SMC.TPP_1.3.3	Apply incident reporting procedures to example occurrence(s)	3	e.g. safety event procedure
											X	X	X	X	ATSEP.QLF.SMC.TPP_2	MAINTENANCE AGREEMENTS WITH OUTSIDE AGENCIES REQUIREMENTS		
											X	X	X	X	ATSEP.QLF.SMC.TPP_2.1	Principles of Agreements		
											X	X	X	X	ATSEP.QLF.SMC.TPP_2.1.1	Describe the principles and need for maintenance agreements	2	e.g. types of service level provided
											X	X	X	X	ATSEP.QLF.SMC.TPP_2.1.2	Describe within which functional areas maintenance agreements will occur	2	e.g. network providers, facilities management, communications
ATSEP QUALIFICATION - Streams														ATSEP UID (Unique Objective Identifier)	CORPUS	Tax	CONTENT	
COM-	COM-Data	NAV-NDR	NAV-DE	NAV-VOR	NAV-DMF	NAV-IIS	SIIP-DCR	SIIP-SSR	SIIP-ADS	DPR-DP	SMC-COM	SMC-NAV	SMC-SIIP					SMC-DP
											X	X	X	X	ATSEP.QLF.SMC.TPP_2.1.3	Describe where in the SMS manual these agreements are included or referenced	2	-
											X	X	X	X	ATSEP.QLF.SMC.TPP_3	SMC GENERAL PROCESSES		
											X	X	X	X	ATSEP.QLF.SMC.TPP_3.1	Roles and Responsibilities		
											X	X	X	X	ATSEP.QLF.SMC.TPP_3.1.1	Describe the role and general method of operations of the SMC	2	-

ATSEP QUALIFICATION - Streams													ATSEP UID (Unique Objective Identifier)	CORPUS	Tax	CONTENT		
COM-	COM-Data	NAV-NDR	NAV-DE	NAV-VOR	NAV-DMF	NAV-ILS	SLIP-DCR	SLIP-SSR	SLIP-ADS	DPR-DP	SMC-COM	SMC-NAV					SMC-SLR	SMC-DP
											X	X	X	X	ATSEP.QLF.SMC.TPP_3.1.2	Describe the need to monitor service conditions and the way to take appropriate action to ensure service performance	2	e.g. process to interrupt services for planned maintenance purposes, management of service provision during corrective maintenance, continuity of service, availability
											X	X	X	X	ATSEP.QLF.SMC.TPP_3.1.3	Describe the coordination role of the SMC	2	e.g. ATSEPs, ATCOs, external service providers, ATM stakeholders
											X	X	X	X	ATSEP.QLF.SMC.TPP_3.1.4	Describe how risk analysis can contribute towards decision-making	2	e.g. assessing risk, handling of service interventions
											X	X	X	X	ATSEP.QLF.SMC.TPP_4	MAINTENANCE MANAGEMENT SYSTEMS		
											X	X	X	X	ATSEP.QLF.SMC.TPP_4.1	Reporting		
											X	X	X	X	ATSEP.QLF.SMC.TPP_4.1.1	Describe how maintenance activities and SMC events/actions are recorded	2	e.g. procedures to follow, terminology to use, record keeping for traceability
											X	X	X	X	ATSEP.QLF.SMC.TPP_4.1.2	Explain the importance of accurate record keeping and dissemination for handover and quality management purposes	2	e.g. information is logged in database or report is generated and distributed according to defined procedures
											X	X	X	X	ATSEP.QLF.SMC.TEC	TECHNOLOGY		
											X	X	X	X	ATSEP.QLF.SMC.TEC_1	TECHNOLOGIES AND PRINCIPLES		
											X	X	X	X	ATSEP.QLF.SMC.TEC_1.1	General		
											X	X	X	X	ATSEP.QLF.SMC.TEC_1.1.1	Describe the principles of control and monitoring systems used	2	e.g. national basis, colour codes, ergonomics

ATSEP QUALIFICATION - Streams														ATSEP UID (Unique Objective Identifier)	CORPUS	Tax	CONTENT	
COM-	COM-Data	NAV-NDR	NAV-DE	NAV-VOR	NAV-DMF	NAV-ILS	SIIR-PCR	SIIR-SSR	SIIR-ADS	DPR-DP	SMC-COM	SMC-NAV	SMC-SIIR					SMC-DP
											X				ATSEP.QLF.SMC.TEC_1.2	Communication		
ATSEP QUALIFICATION - Streams														ATSEP UID (Unique Objective Identifier)	CORPUS	Tax	CONTENT	
COM-	COM-Data	NAV-NDR	NAV-DE	NAV-VOR	NAV-DMF	NAV-ILS	SIIR-PCR	SIIR-SSR	SIIR-ADS	DPR-DP	SMC-COM	SMC-NAV	SMC-SIIR					SMC-DP
											X				ATSEP.QLF.SMC.TEC_1.2.1	Describe the key aspects of control and monitoring system capability	2	e.g. parameters presented to the SMC and types of actions that can be taken
											X				ATSEP.QLF.SMC.TEC_1.2.2	Appreciate the impact of the replacement of components in a communication chain	3	Continuity of service, communication chain integrity
												X			ATSEP.QLF.SMC.TEC_1.3	Navigation		
												X			ATSEP.QLF.SMC.TEC_1.3.1	Describe the key aspects of control and monitoring system capability	2	e.g. parameters presented to the SMC and types of actions that can be taken
												X			ATSEP.QLF.SMC.TEC_1.3.2	Appreciate the impact of the replacement of components in navigation equipment	3	Continuity of service, navigation aid integrity
													X		ATSEP.QLF.SMC.TEC_1.4	Surveillance		
													X		ATSEP.QLF.SMC.TEC_1.4.1	Describe the key aspects of control and monitoring system capability	2	e.g. parameters presented to the SMC and types of actions that can be taken
													X		ATSEP.QLF.SMC.TEC_1.4.2	Appreciate the impact of the replacement of components in a surveillance chain	3	Continuity of service, surveillance chain integrity
														X	ATSEP.QLF.SMC.TEC_1.5	Data Processing		

ATSEP QUALIFICATION - Streams														ATSEP UUID (Unique Objective Identifier)	CORPUS	Tax	CONTENT	
COM-	COM-Data	NAV-NDR	NAV-DE	NAV-VOR	NAV-DMF	NAV-ILS	SIIR-DCR	SIIR-SSR	SIIR-ADS	DPR-DP	SMC-COM	SMC-NAV	SMC-SIIR					SMC-DP
														X	ATSEP.QLF.SMC.TEC_1.5.1	Describe the key aspects of control and monitoring system capability	2	e.g. parameters presented to the SMC and types of actions that can be taken
														X	ATSEP.QLF.SMC.TEC_1.5.2	Appreciate the impact of the replacement of components in data processing chain	3	Continuity of service, data processing, chain integrity
											X	X	X	X	ATSEP.QLF.SMC.TEC_1.6	Facilities		
											X	X	X	X	ATSEP.QLF.SMC.TEC_1.6.1	Describe the key aspects of system management capability	2	e.g. parameters presented to the SMC and types of actions that can be taken
											X	X	X	X	ATSEP.QLF.SMC.TEC_1.6.2	Appreciate the impact of the loss of supply and/or replacement of components in facility equipment	3	Continuity of service, integrity

Appendix 5a — General guidelines

ED Decision 2020/020/R

SYLLABI STRUCTURE

This guidance material provides explanatory material on how to read the tables in the appendices contained in Subpart A of the AMC & GM to Part-PERS.

Four tables are provided:

- (a) Basic training — Shared (Appendix 1a);
- (b) Basic training — Streams (Appendix 2a);
- (c) Qualification training — Shared (Appendix 3a); and
- (d) Qualification training — Streams (Appendix 4a).

The tables have the following structure:

Granularity Table (a)													Objective Identifiers (b)		Training Objectives (c)		
COM-Voice	COM-Data	NAV-NDB	NAV-DF	NAV-VOR	NAV-DME	NAV-ILS	SUR-PSR	SUR-ADS	DPR-DP	SMC-COM	SMC-NAV	SMC-SUR	SMC-DP	ATSEP.UOID (Unique Objective Identifier)	CORPUS	Tax	CONTENT
							X	X			X	X		ATSEP.QLF.SUR	ATSEP QUALIFICATION DOMAIN - SURVEILLANCE		
							X	X			X	X		ATSEP.QLF.SUR.PSR	PRIMARY SURVEILLANCE RADAR (PSR)		
							X	X			X	X		ATSEP.QLF.SUR.PSR_1	PSR		
							X	X			X	X		ATSEP.QLF.SUR.PSR_1.1	Use of PSR for Air Traffic Services		
							X	X			X	X		ATSEP.QLF.SUR.PSR_1.1.1	Describe the operational requirements of an en-route or an approach PSR	2	Range, resolution, coverage, availability
							X	X			X	X		ATSEP.QLF.SUR.PSR_1.1.2	Relate key parameters of PSR to system performance	4	Key parameters: PSR: signal energy, frequency diversity, antenna gain, update rate, polarisation, receiver MDS, beamwidth Performance: range, accuracy, resolution, extractor minimum target threshold, weather influence, PD, blind speed, ambiguities, capacity e.g. weather channel
							X	X			X	X		ATSEP.QLF.SUR.PSR_1.2	Antenna (PSR)		
							X	X			X	X		ATSEP.QLF.SUR.PSR_1.2.1	Describe antenna types, accuracy and problems	2	Antenna beam(s), side lobes, reflector antenna, active (phased array) antenna, rotating joints, waveguide interface, pressurisation, dehumidification, polarisation, azimuth encoding, drive systems

Figure 1: Structure of tables

- (a) Granularity table (Appendix 4a only)

The granularity table indicates the stream(s) with which the objectives are associated. Where objectives are common to multiple streams, it is necessary to only include the objective once in the ATSEP training syllabus.

- (b) ATSEP unique objective identifier (UOID)

This is a unique identifier for each objective. Where objectives are repeated across multiple streams, the UOID is linked to the parent domain.

The structure of the UOID is the following:

AREA.DOMAIN.SUBJECT_topic#.subtopic#.objective#

An example of a UOID decoding for ATSEP.QLF.SUR.PSR_1.2.1:

- ATSEP: fixed field that indicates the training area;
- QLF.SUR.: phase of training (qualification) and domain (surveillance);
- (Note: basic training uses only 'BAS' without a second field);
- PSR: subject (primary surveillance radar);

- `_1`: topic number (PSR);
- `.2`: subtopic number (antenna (PSR)); and
- `.1`: objective number (1).

(c) Training objectives

Each training objective contains three mandatory elements:

(1) Corpus

A description of the required performance. It always contains an action verb at the beginning of the sentence to ensure that the outcome is observable. The action verb is always associated with a defined taxonomy.

The tables at the end of this section list action verbs and their associated taxonomy levels. Those verbs and levels are used or may be used for training objectives.

(2) Taxonomy Level

A numerical representation of the classification of the action verb.

- (i) Level 1: basic knowledge of the subject. It is the ability to remember essential points, memorise data, and retrieve it.
- (ii) Level 2: the ability to understand and discuss the subject matter intelligently in order to describe and act on certain objects and events.
- (iii) Level 3: thorough knowledge of the subject and the ability to apply it with accuracy. The ability to make use of the repertoire of knowledge to develop plans and activate them.
- (iv) Level 4: the ability to establish a line of action within a unit of known applications by following the correct chronology and the adequate method to resolve a problem situation. This involves integrating known applications into a familiar situation.
- (v) Level 5: the ability to analyse new situations in order to elaborate and apply one or another relevant strategy to solve a complex problem. The defining feature is that the situation is qualitatively different to those previously met, requiring judgement and evaluation of options.

The content illustrates and details performance.

When the items are in a list, each of them is to be addressed as a minimum.

‘e.g.’ is used to indicate optional content. All content following ‘e.g.’ is provided to illustrate the type of content that could be used to meet the objective.

When there is no mandatory content, the objective has to be performed according to the action verb.

Where content refers to other documents (e.g. ICAO SARPs, EU regulations, etc.), users should take care to use the most recent version(s) of the referenced document(s) or its/their parts.

(d) Domain

The domain is indicated through **white text on blue background**.

The following domains are defined:

QLF.SHR SHARED (common part for all qualification domains);

QLF.COM	COMMUNICATION;
QLF.NAV	NAVIGATION;
QLF.SUR	SURVEILLANCE;
QLF.DPR	DATA PROCESSING; and
QLF.SMC	SYSTEM MONITORING AND CONTROL.

In addition, basic training is also considered to be a domain in the tables:

BAS BASIC.

(e) Subject

The subject is indicated through **black text on dark grey background**.

A subject structures the domain into smaller elements.

(f) Topic

The topic is indicated through **black text on mid grey background**.

A topic structures the subject into smaller elements.

(g) Subtopic

The subtopic is indicated through **black text on light grey background**.

A subtopic structures the topic into smaller elements.

(h) Action verbs

The tables below list action verbs and their associated taxonomy levels that are used in training objectives.

Definition of verbs — Level 1

Verb	Definition	Example
Define	State what it is and what its limits are; state the definition.	Define airborne safety nets.
Draw	Produce a picture, pattern, or diagram.	Draw the MLAT system architecture.
List	Say one after the other.	List the most common weather messages.
Name	Give the name of objects or procedures.	Name a range of air-ground aviation-related network concepts.
Recognise	Know what it is, because you have seen it before.	Recognise surveillance information on a display.
State	Say or write in a formal or definite way.	State the function of a network management system.

Definition of verbs — Level 2

Verb	Definition	Example
Characterise	Describe the quality of features in something.	Characterise navigation methods.
Consider	Think carefully about it.	Consider the benefits of Critical Incident Stress Management (CISM).
Demonstrate	Describe and explain. Logically or mathematically, prove the truth of the statement.	Demonstrate the use of middleware in an ATM environment.

Describe	Say what it is like or what happened.	Describe the elements of Global Navigation Satellite System (GNSS) in Europe.
Differentiate	Show the difference between things.	Differentiate conventional navigation from area navigation.
Explain	Give details about something or describe so that it can be understood.	Explain the function of FDP.
Take account of	Take into consideration before deciding.	Take account of hardware/software compatibility.

Definition of verbs — Level 3

Verb	Definition	Example
Apply	Use something in a situation or activity.	Apply the principles of layers.
Appreciate	Understand a situation and know what is involved in a problem-solving situation, to state a plan without applying it.	Appreciate how to troubleshoot a network.
Calculate	Discover from information you already have by arithmetic; to think about a possible cause of action in order to form an opinion or decide what to do.	Calculate parameters of a line.
Check	Make sure the information is correct (satisfactory).	Check the conformity of a system to ITU and national regulation.
Decode	Turn into ordinary writing, decipher.	Decode a typical OLDI message.
Estimate	Form an approximate judgement of a number, form an opinion.	Estimate the impact of security and integrity failure to the operational service.
Identify	Associate oneself inseparably with, establish the identity.	Identify the major elements of the ADS-C system.
Operate	Conduct work on equipment.	Operate measuring equipment.
Perform	Carry into effect, go through, execute.	Perform measurements with generic radio test equipment.
Use	Employ for a purpose, handle as instrument, put into operation.	Use appropriate vocabulary to communicate effectively on technical matters.

Definition of verbs — Level 4

Verb	Definition	Example
Adjust	Change to a new position, value or setting.	Adjust a generic radio receiver.
Analyse	Examine minutely the constitution of.	Analyse the block diagram of a generic radio receiver.
Justify	Show the rightness of a choice or of an option.	Justify the occasions when it is necessary to downgrade an ILS facility performance category.
Relate	Establish link with.	Relate VOR station design to operational requirement.

Definition of verbs — Level 5

Verb	Definition	Example
Interpret	Decide on the meaning or significance of something when there is a choice.	Interpret ILS facility performance categories.

(i) Acronyms

The following abbreviations are used in the tables:

AAIM	Aircraft Autonomous Integrity Monitoring
ABAS	Aircraft-Based Augmentation System
ACARS	Aircraft Communications Addressing and Reporting System
ACAS	Airborne Collision Avoidance System
ACC	Area Control Centre
A/D	Analogue/Digital
ADEX-P	ATS Data Exchange Presentation
ADS	Automatic Dependent Surveillance
ADS B	ADS — Broadcast
ADS C	ADS — Contract
ADF	Automatic Direction Finder
AFDX	Avionics Full-duplex Ethernet Switch
AFTN	Aeronautical Fixed Telecommunications Network
AGC	Automatic Gain Control
AIC	Aeronautical Information Circular
AIDC	ATS Interfacility Data Communications
AIP	Aeronautical Information Publication
AIRAC	Aeronautical Information Regulation and Control
AIS	Aeronautical Information Services
ALARP	As Low As Reasonably Practicable
AMAN	Arrival Manager
AMHS	Aeronautical Message Handling System
AMSS	Automatic Message Switching System
ANS	Air Navigation Services
ANSP	ANS Provider
APV	Approach Procedure with Vertical guidance
APW	Area Proximity Warning
ARINC	Aeronautical Radio Incorporated
ARTAS	ATC Radar Tracker and Server
ASAS	Airborne Separation Assistance/Assurance System
ASM	Airspace Management
ASMGCS	Advanced SMGCS
ASTERIX	All-purpose Structured EUROCONTROL Radar Information Exchange
ATC	Air Traffic Control
ATFCM	Air Traffic Flow and Capacity Management
ATIS	Automatic Terminal Information Service
ATM	Air Traffic Management
ATN	Aeronautical Telecommunication Network

ATS	Air Traffic Services
ATSEP	Air Traffic Safety Electronics Personnel
AUGUR	EUROCONTROL RAIM Prediction Tool
BATAP	'Type-B' Application-to-Application Protocol
BDS	Binary Data Store
BER	Bit Error Rate
BITE	Built-In Test Equipment
B-RNAV	Basic-RNAV
CAA	Civil Aviation Authority
CB	Cumulonimbus
CBT	Computer-Based Training
CDM	Collaborative Decision-Making
CDTI	Cockpit Display of Traffic Information
CFMU	Central Flow Management Unit
CIDIN	Common ICAO Data Interchange Network
CISM	Critical Incident Stress Management
CIV	Civil
CLAM	Cleared flight Level Adherence Monitoring
CLIMAX	Multi-station carrier offset mode, with voting override
CMS	Control and Monitoring System
CNS/ATM	Communication Navigation and Surveillance/Air Traffic Management
CORA	Conflict Resolution Advisory
CORBA	Common Object Request Broker Architecture
COTS	Commercial off-the-Shelf
CPDLC	Controller-Pilot Data Link Communications
CRT	Cathode Ray Tube
CSU	Control Sector Unit
CTR	Control Zone
CVOR	Conventional VOR
CWP	Controller Work Position
DCL	Departure Clearance
DDF	Doppler DF
DDM	Difference of Depth of Modulation
DF	Direction Finding
DLIC	Data Link Initiation Capability
DMAN	Departure Manager
DME	Distance Measuring Equipment
DPSK	Differential Phase Shift Keying
DTMF	Dual Tone Modulation-Frequency
DVOR	Doppler VOR
EAD	European Aeronautical Database
EAN	European ANSP Network
EASA	European Aviation Safety Agency
ECAC	European Civil Aviation Conference
EFQM	European Foundation for Quality Management
EGNOS	European Geostationary Navigation Overlay Service

EGPWS	Enhanced Ground Proximity Warning System
EHS	Enhanced Mode S
EHT	Extremely High Tension
EJB	Enterprise Java Bean
ELS	Elementary Mode S
EMC	Electromagnetic Compatibility
EMI	Electromagnetic Interference
ETFMS	Enhanced Tactical FMS
EU	European Union
EUROCAE	European Civil Aviation Electronics
EUROCONTROL	European Organisation for the Safety of Air Navigation
FAA	Federal Aviation Administration (US)
FANS	Future Air Navigation Systems
FDP	Flight Data Processing
FDPS	FDP System
FFM	Far Field Monitor
FHA	Functional Hazard Assessment
FIR	Flight Information Region
FMS	Flight Management System
FMTP	Flight Plan Messaging Transport Protocol
FoM	Figures of Merit
FPL	(Filed) Flight Plan
FRUIT	False Reply Unsynchronised in Time
FUA	Flexible Use of Airspace
GALILEO	Satellite radio navigation system
GBAS	Ground-Based Augmentation System
GLONASS	GLOBAL'naya NAVigatsionnaya Sputnikovaya Sistema (Global Navigation Satellite System)
GNSS	Global Navigation Satellite System
GP	Glide Path
GPS	Global Positioning System
GRAS	Ground-based Regional Augmentation System
GSA	GNSS Supervisory Authority
GTC	Gain/Time Control
HF	High Frequency
HFDL	High Frequency Data Link
HMI	Human-Machine Interface
HPA	High Power Amplifier
HSI	Horizontal Situation Indication
HV	High Voltage
HW	Hardware
Hz	Hertz
ICAO	International Civil Aviation Organization
IDF	Interferometric DF
IF	Intermediate Frequency
IFF	Identification Friend/Foe
IFPS	(Integrated) Initial Flight Plan Processing System

ILS	Instrument Landing System
INS	Inertial Navigation System
I/O	Input/Output
IP	Internet Protocol
IRS	Inertial Reference System
IRVR	Instrument Runway Visual Range
I/Q	In phase and Quadrature
ISDN	Integrated Services Digital Network
ISLS	Interrogator Side Lobe Suppression
IISLS	Improved Interrogator Side Lobe Suppression
ITEC	Interoperability Through European Collaboration
ITU	International Telecommunication Union
ISO	International Standards Organisation
LAM	Local Area Multilateration
LAN	Local Area Network
LAPB	Link Access Protocol, Balanced
LCD	Liquid-Crystal Display
LLZ	Localiser
LNA	Low Noise Amplifier
LVP	Low Visibility Procedures
MDS	Minimum Detectable Signal
MET	Meteorology
METAR	Meteorological Actual Report
MFC	Multi-Frequency Coding
MHz	Megahertz
MIL	Military
MLAT	Multilateration
MLS	Microwave Landing System
MOTNE	Meteorological Operational Telecommunications Network Europe
MRP	Multi-radar Processing
MRT	Multi-radar Tracker
MSAW	Minimum Safe Altitude Warning
MSSR	Mono-pulse SSR
MTBF	Mean Time Between Failure
MTCD	Medium-Term Conflict Detection
MTD	Moving Target Detection
NAVAID	Navigation(al) Aid
ND	Navigation Display
NEAN	North European ADS-B Network
NDB	Non-Directional Beacon
NOP	Network Operations Plan
NOTAM	Notice to Airmen
NPA	Non-Precision Approach
NRA	Non-Radar Area
NSA	National Supervisory Authority
OJTI	On-The-Job Training Instructor

OLDI	On-Line Data Interchange
OS	Operating System
OSI	Open System Interconnection
OST	On-site Training
OTM	Object Transaction Monitor
PA	Precision Approach
PABX	Private Automatic Branch Exchange
PBN	Performance-Based Navigation
PCM	Pulse Code Modulation
PD	Probability of Detection
PENS	Pan-European Fixed Network Services
PFD	Primary Flight Display
PPI	Plan Position Indicator
PRF	Pulse Repetition Frequency
P-RNAV	Precision RNAV
PSD	Phase Sensitive Detector
PSSA	Preliminary System Safety Assessment
PSR	Primary Surveillance Radar
QoS	Quality of Service
QNH	Q-code for atmospheric pressure at sea level
Qsig	Quality of signal
RAIM	Receiver Autonomous Integrity Monitoring
RAPNET	(European) Regional Aeronautical Packet switched Network (CBN + DAKOS)
RAPS	Recording, Analysis, Playback and Simulation system for radar data (COMSOFT)
RDP	Radar Data Processing
RCA	Remote Client Application
RF	Radio Frequency
RMI	Relative Magnetic Indicator
RNAV	Area Navigation
RNP	Required Navigation Performance
RPL	Repetitive Flight Plan
RSLS	Receiver Sidelobe Suppression
R/T	Radiotelephony
RTCA	Radio Technical Commission for Aeronautics
RUP	Rational Unified Process
RVR	Runway Visual Range
RX	Receiver
SAR	Specific Energy Absorption Rate
SARPS	Standards And Recommended Practices
SASS	Surveillance Analysis Support System
SASS-C	SASS-Centre
SASS-S	SASS-Sensor
SATCOM	Satellite Communications
SBAS	Satellite-Based Augmentation System
SCAS	Surveillance Coverage Analysis Suite
SCAT-1	Special Category 1

SDM	Sum of Depth of Modulation
SDP	Surveillance Data Processing
S/E	System/Equipment
SELCAL	Selective Calling
SESAR	Single European Sky AM Research
SID	Standard Instrument Departure
SITA	Société Internationale de Télécommunications Aéronautiques (France)
SMC	System Monitoring and Control
SMR	Surface Movement Radar
SMS	Safety Management System
S/N	Signal/Noise
SNOWTAM	NOTAM on Snow conditions
SNMP	Simple Network Management Protocol
SPI	Special Pulse Identification or Special Position Identification Pulse (SSR)
SRC	Safety Regulation Commission (EUROCONTROL)
SSA	System Safety Assessment
SSR	Secondary Surveillance Radar
STC	Sensitivity Time Control
STCA	Short-Term Conflict Alert
SV	Supervisor
SW	Software
SWALs	Software Assurance Levels
SWIM	System Wide Information Management
SWR	Standing Wave Ratio
TACAN	UHF Tactical Air Navigation aid
TAF	Terminal Area Forecast
TCAS	Transponder Collision Avoidance System
TCP	Transmission Control Protocol
TDOA	Time Difference on Arrival
TFT	Thin Film Transistor
TIS	Traffic Information Service
TMA	Terminal Area
TRM	Team Resource Management
TX	Transmitter
UAT	Universal Access Transceiver
UBSS	UNIX Basic System Software
UHF	Ultra High Frequency
UPS	Uninterruptible Power Supply
UTA	Upper (Traffic) Control Area
VCS	Voice Communications System
VDF	VHF DF Station
VDL	VHF Digital/Data Link
VESDA	Very Early Smoke Detection Alarm
VHF	Very High Frequency
VOLMET	Routine Voice broadcasts for Meteorological Information

VOR	VHF Omnidirectional Radio Range
VORTAC	VOR and TACAN combination
WAAS	Wide Area Augmentation System (US)
WAM	Wide Area Multilateration
WAN	Wide Area Network
WGS84	World Geodetic System 84